

Ferrite

For Switching Power Supplies
Technical Data

EI, EE, EER, ETD, PQ, LP, RM, EPC Series

EI Cores (EI12.5 to EI60)

EE Cores (EE10/11 to EE62.3/62/6)

EER Cores (EER25.5 to EER42/42/20)

ETD Cores (ETD19 to ETD49)

PQ Cores (PQ20/16 to PQ50/50)

LP Cores (LP23/8 to LP32/13)

RM Cores (RM4 to RM14)

EPC Cores (EPC13 to EPC30)

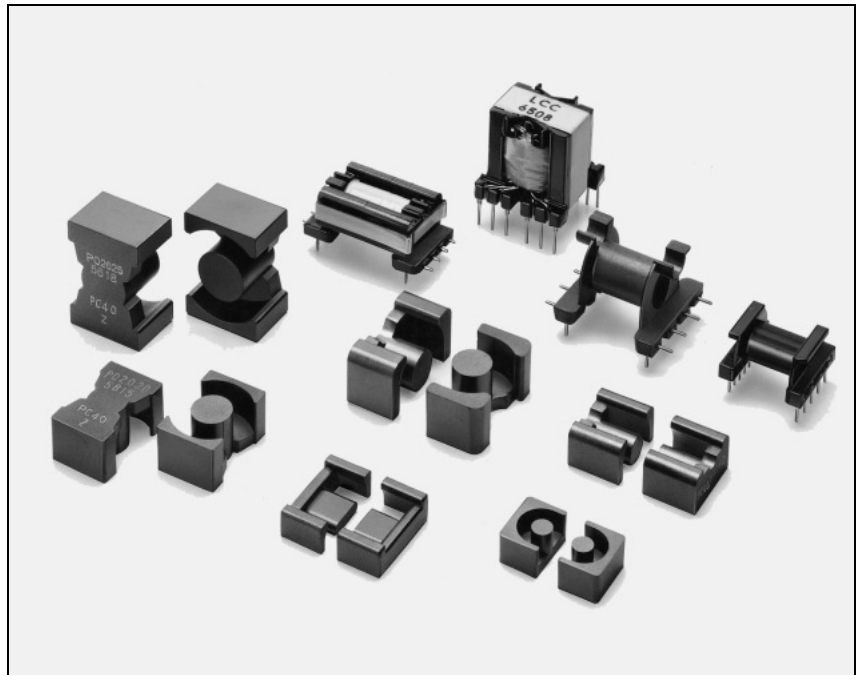

Ferrite

For Switching Power Supplies

Technical Data

EI Series EI12.5 Cores

JIS FEI 12.5

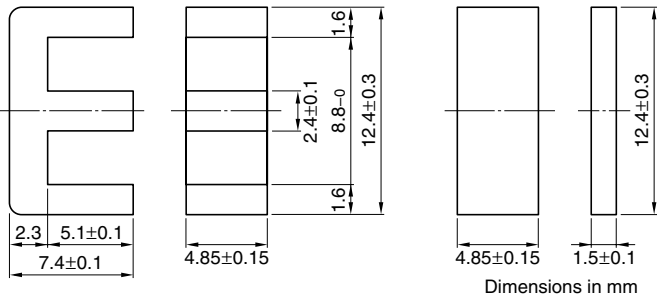

Parameter

Core factor	C1	mm ⁻¹	1.48
Effective magnetic path length	ℓ _e	mm	21.3
Effective cross-sectional area	A _e	mm ²	14.4
Effective core volume	V _e	mm ³	308
Cross-sectional center leg area	A _{cp}	mm ²	11.6
Minimum cross-sectional area	A _{cp min.}	mm ²	10.8
Cross-sectional winding area of core	A _{cw}	mm ²	17.3
Weight (approx.)		g	1.9

Part No.	AL-value (nH/N ²)	Core loss (W) at 100°C	Calculated output power (forward converter mode)
		100kHz, 200mT	
PC40EI12.5-Z	1200±25% (1kHz, 0.5mA)* 2120 min. (100kHz, 200mT)	0.12 max.	8.8W (100kHz)

* Coil: ø0.2 2UEW 100Ts

NI limit vs. AL-value for PC40EI12.5 gapped core (Typical)

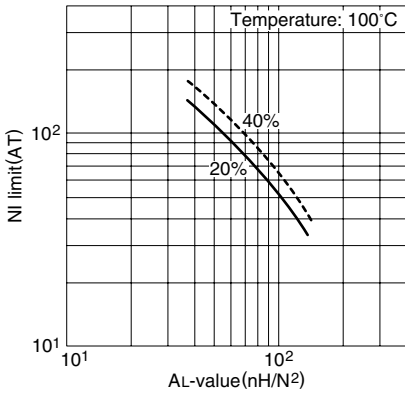

Note: NI limit shows the point where the exciting current is 20% and 40% away from its extended linear part.

AL-value vs. Air gap length for PC40EI12.5 core (Typical)

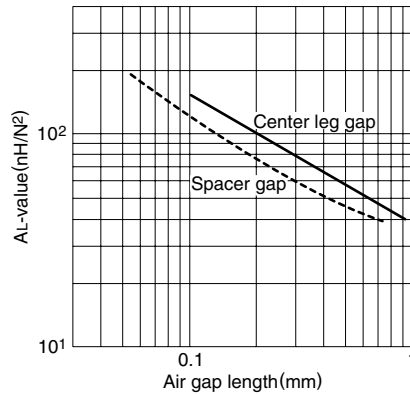

Measuring conditions • Coil: ø0.2 2UEW 100Ts
• Frequency: 1kHz
• Level: 0.5mA

Temperature rise vs. Total loss for EI12.5 core (Typical) (Ambient temperature: 25°C)

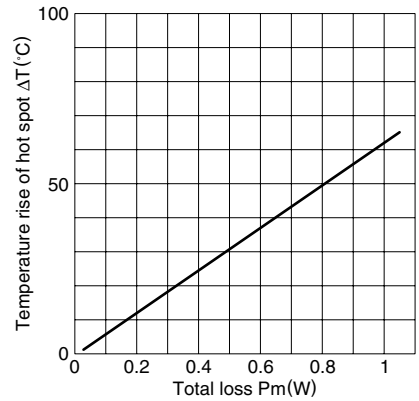

Note: The temperature rise is measured in the room whose temperature and humidity are fixed to 25°C and 45%(%)RH, respectively. (approx. 400×300×300cm)

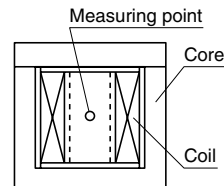

Ferrite

For Switching Power Supplies

Technical Data

EI Series EI16 Cores

JIS FEI 16

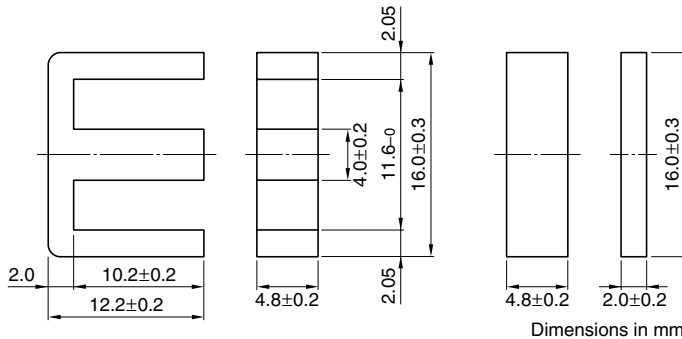

Parameter

Core factor	C1	mm ⁻¹	1.75
Effective magnetic path length	ℓ _e	mm	34.6
Effective cross-sectional area	A _e	mm ²	19.8
Effective core volume	V _e	mm ³	670
Cross-sectional center leg area	A _{cp}	mm ²	19.2
Minimum cross-sectional area	A _{cp min.}	mm ²	17.5
Cross-sectional winding area of core	A _{cw}	mm ²	40.3
Weight (approx.)		g	3.3

Part No.	AL-value (nH/N ²)	Core loss (W) at 100°C	Calculated output power
		100kHz, 200mT	(forward converter mode)
PC40EI16-Z	1100±25% (1kHz, 0.5mA)* 1750 min. (100kHz, 200mT)	0.31 max.	29W (100kHz)

* Coil: ø0.23 2UEW 100Ts

NI limit vs. AL-value for PC40EI16 gapped core (Typical)

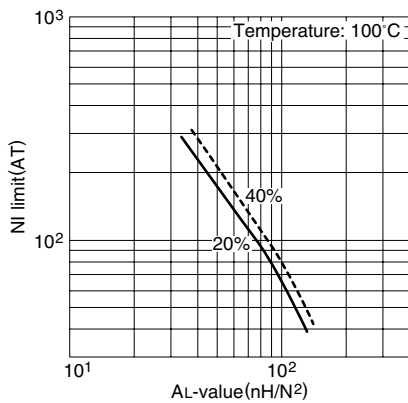

Note: NI limit shows the point where the exciting current is 20% and 40% away from its extended linear part.

AL-value vs. Air gap length for PC40EI16 core (Typical)

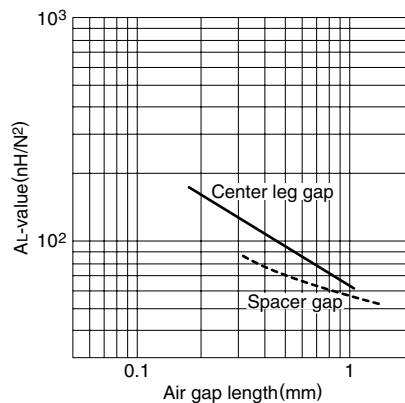

Measuring conditions • Coil: ø0.23 2UEW 100Ts
• Frequency: 1kHz
• Level: 0.5mA

Temperature rise vs. Total loss for EI16 core (Typical) (Ambient temperature: 25°C)

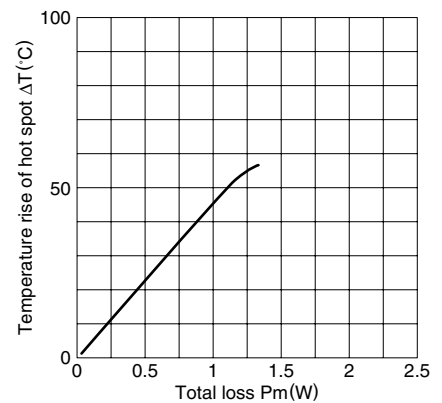

Note: The temperature rise is measured in the room whose temperature and humidity are fixed to 25°C and 45%RH, respectively. (approx. 400×300×300cm)

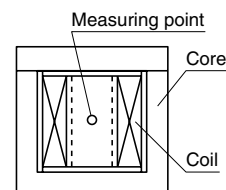

Ferrite

For Switching Power Supplies

Technical Data

EI Series EI19 Cores

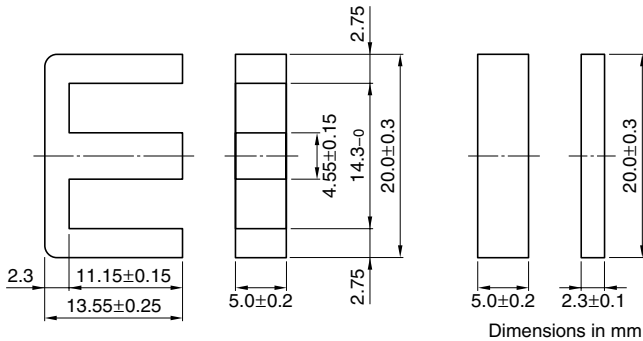

Parameter

Core factor	C1	mm ⁻¹	1.65
Effective magnetic path length	ℓ _e	mm	39.6
Effective cross-sectional area	A _e	mm ²	24.0
Effective core volume	V _e	mm ³	950
Cross-sectional center leg area	A _{cp}	mm ²	22.8
Minimum cross-sectional area	A _{cp min.}	mm ²	21.1
Cross-sectional winding area of core	A _{cw}	mm ²	55.5
Weight (approx.)		g	5.1

Part No.	AL-value (nH/N ²)	Core loss (W) at 100°C	Calculated output power (forward converter mode)
		100kHz, 200mT	
PC40EI19-Z	1400±25% (1kHz, 0.5mA)* 1930 min. (100kHz, 200mT)	0.42 max.	40W (100kHz)

* Coil: ø0.23 2UEW 100Ts

NI limit vs. AL-value for PC40EI19 gapped core (Typical)

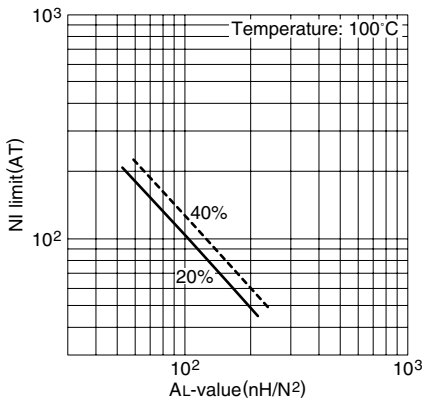

Note: NI limit shows the point where the exciting current is 20% and 40% away from its extended linear part.

AL-value vs. Air gap length for PC40EI19 core (Typical)

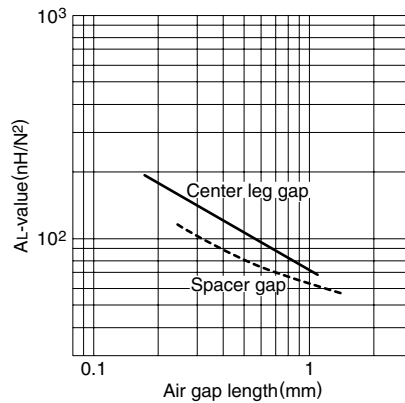

Measuring conditions • Coil: ø0.23 2UEW 100Ts
• Frequency: 1kHz
• Level: 0.5mA

Temperature rise vs. Total loss for EI19 core (Typical) (Ambient temperature: 25°C)

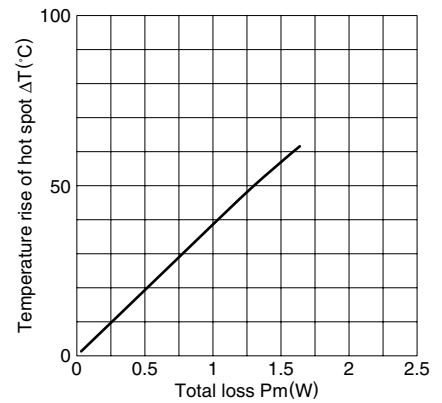

Note: The temperature rise is measured in the room whose temperature and humidity are fixed to 25°C and 45%RH, respectively. (approx. 400×300×300cm)

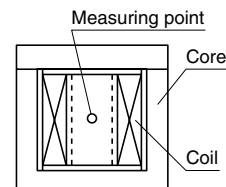

Ferrite

For Switching Power Supplies

Technical Data

EI Series EI22 Cores

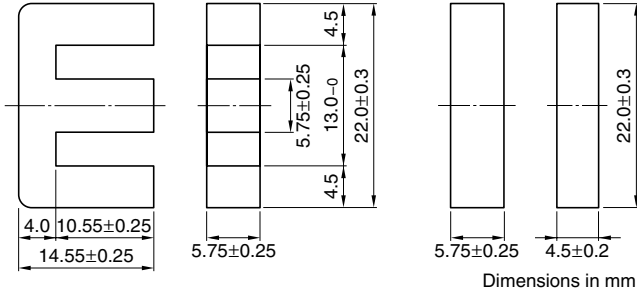

Parameter

Core factor	C1	mm ⁻¹	0.936
Effective magnetic path length	ℓ _e	mm	39.3
Effective cross-sectional area	A _e	mm ²	42.0
Effective core volume	V _e	mm ³	1630
Cross-sectional center leg area	A _{cp}	mm ²	33.1
Minimum cross-sectional area	A _{cp min.}	mm ²	30.3
Cross-sectional winding area of core	A _{cw}	mm ²	38.2
Weight (approx.)		g	9.8

Part No.	AL-value (nH/N ²)	Core loss (W) at 100°C	Calculated output power
		100kHz, 200mT	(forward converter mode)
PC40EI22-Z	2400±25% (1kHz, 0.5mA)* 3360 min. (100kHz, 200mT)	0.60 max.	33W (100kHz)

* Coil: ø0.23 2UEW 100Ts

NI limit vs. AL-value for PC40EI22 gapped core (Typical)

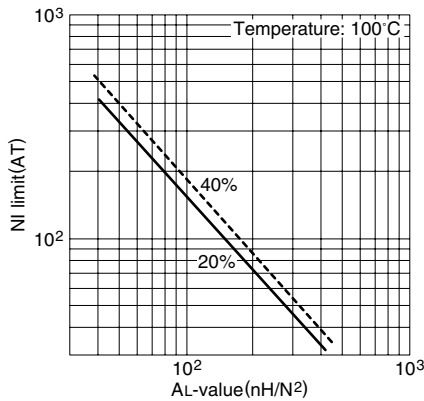

Note: NI limit shows the point where the exciting current is 20% and 40% away from its extended linear part.

AL-value vs. Air gap length for PC40EI22 core (Typical)

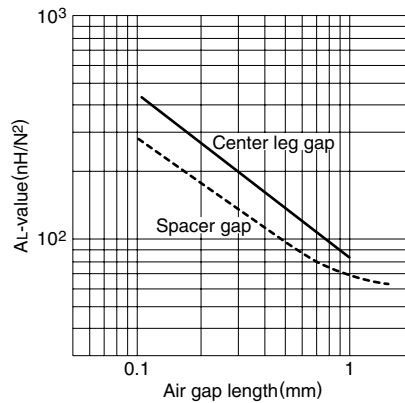

Measuring conditions • Coil: ø0.23 2UEW 100Ts
• Frequency: 1kHz
• Level: 0.5mA

Temperature rise vs. Total loss for EI22 core (Typical)
(Ambient temperature: 25°C)

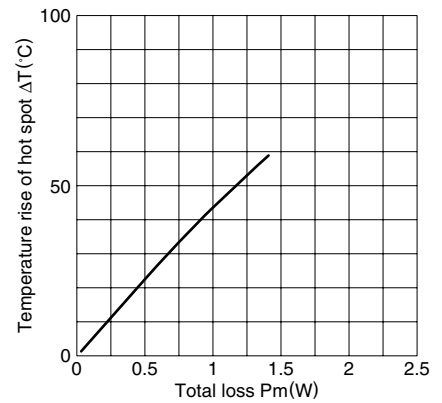

Note: The temperature rise is measured in the room whose temperature and humidity are fixed to 25°C and 45%RH, respectively. (approx. 400×300×300cm)

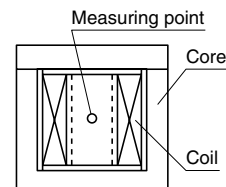

Ferrite

For Switching Power Supplies

Technical Data

EI Series EI22/19/6 Cores

JIS FEI 22

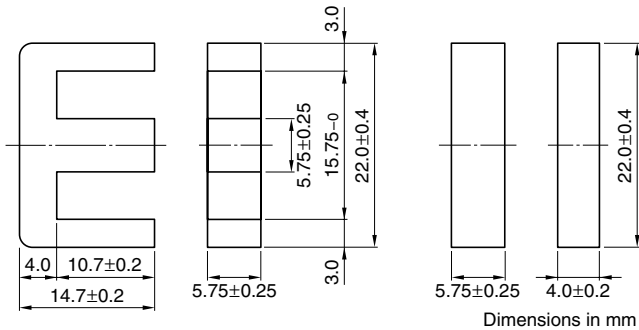

Parameter

Core factor	C1	mm ⁻¹	1.13
Effective magnetic path length	ℓ _e	mm	41.8
Effective cross-sectional area	A _e	mm ²	37.0
Effective core volume	V _e	mm ³	1550
Cross-sectional center leg area	A _{cp}	mm ²	33.1
Minimum cross-sectional area	A _{cp min.}	mm ²	30.3
Cross-sectional winding area of core	A _{cw}	mm ²	54.8
Weight (approx.)		g	8.5

Part No.	AL-value (nH/N ²)	Core loss (W) at 100°C	Calculated output power
		100kHz, 200mT	(forward converter mode)
PC40EI22/19/6-Z	2000±25% (1kHz, 0.5mA)* 2780 min. (100kHz, 200mT)	0.64 max.	48W (100kHz)

* Coil: ø0.23 2UEW 100Ts

NI limit vs. AL-value for PC40EI22/19/6 gapped core (Typical)

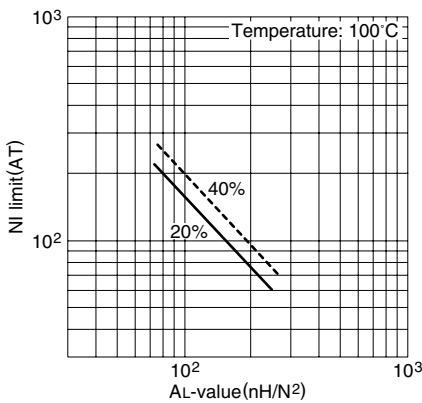

Note: NI limit shows the point where the exciting current is 20% and 40% away from its extended linear part.

AL-value vs. Air gap length for PC40EI22/19/6 core (Typical)

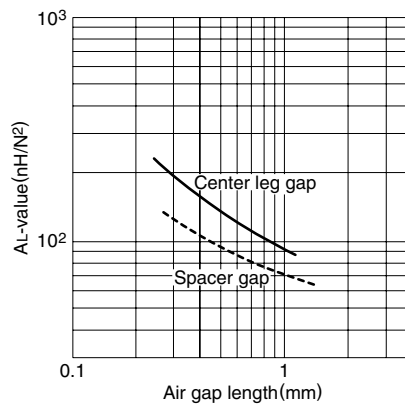

Measuring conditions • Coil: ø0.23 2UEW 100Ts
• Frequency: 1kHz
• Level: 0.5mA

Temperature rise vs. Total loss for EI22/19/6 core (Typical) (Ambient temperature: 25°C)

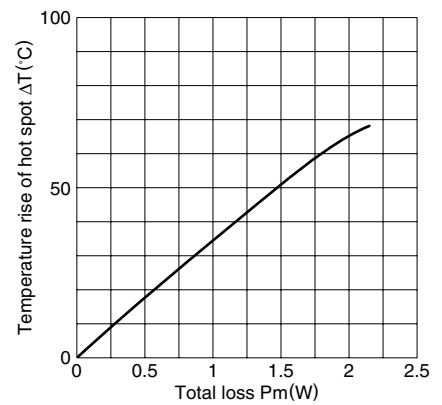

Note: The temperature rise is measured in the room whose temperature and humidity are fixed to 25°C and 45%RH, respectively. (approx. 400×300×300cm)

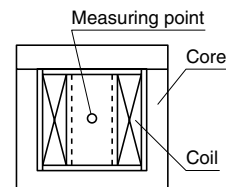

Ferrite

For Switching Power Supplies

Technical Data

EI Series EI25 Cores

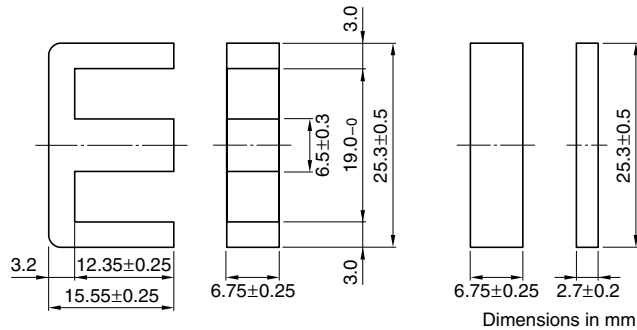

Parameter

Core factor	C1	mm ⁻¹	1.15
Effective magnetic path length	ℓ _e	mm	47.0
Effective cross-sectional area	A _e	mm ²	41.0
Effective core volume	V _e	mm ³	1930
Cross-sectional center leg area	A _{cp}	mm ²	43.9
Minimum cross-sectional area	A _{cp min.}	mm ²	40.3
Cross-sectional winding area of core	A _{cw}	mm ²	77.2
Weight (approx.)		g	9.8

Part No.	AL-value (nH/N ²)	Core loss (W) at 100°C 100kHz, 200mT	Calculated output power (forward converter mode)
PC40EI25-Z	2140±25% (1kHz, 0.5mA)* 2950 min. (100kHz, 200mT)	0.79 max.	68W (100kHz)

* Coil: ø0.35 2UEW 100Ts

NI limit vs. AL-value for PC40EI25 gapped core (Typical)

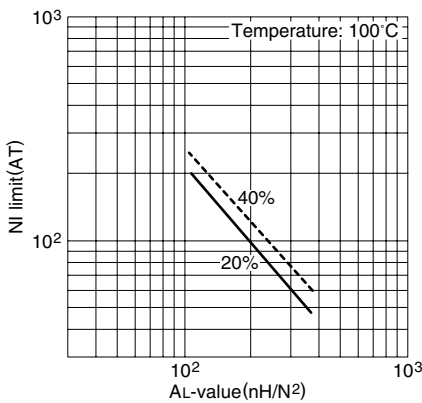

Note: NI limit shows the point where the exciting current is 20% and 40% away from its extended linear part.

AL-value vs. Air gap length for PC40EI25 core (Typical)

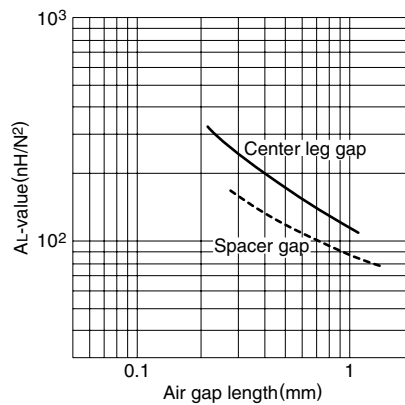

Measuring conditions • Coil: ø0.35 2UEW 100Ts
• Frequency: 1kHz
• Level: 0.5mA

Temperature rise vs. Total loss for EI25 core (Typical) (Ambient temperature: 25°C)

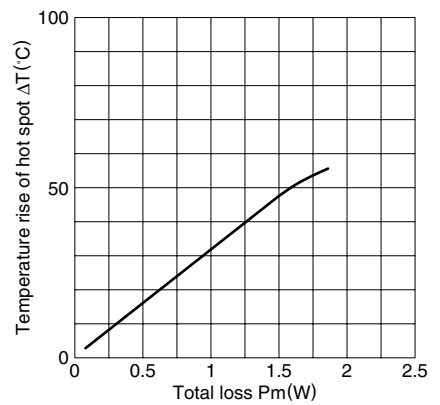

Note: The temperature rise is measured in the room whose temperature and humidity are fixed to 25°C and 45%RH, respectively. (approx. 400×300×300cm)

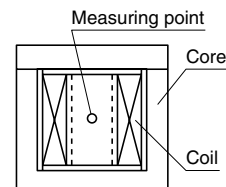

Ferrite

For Switching Power Supplies

Technical Data

EI Series EI28 Cores

JIS FEI 28

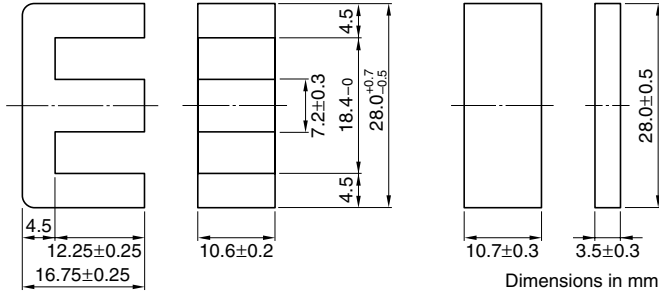

Parameter

Core factor	C1	mm ⁻¹	0.560
Effective magnetic path length	ℓ _e	mm	48.2
Effective cross-sectional area	A _e	mm ²	86.0
Effective core volume	V _e	mm ³	4150
Cross-sectional center leg area	A _{cp}	mm ²	76.3
Minimum cross-sectional area	A _{cp min.}	mm ²	71.8
Cross-sectional winding area of core	A _{cw}	mm ²	69.8
Weight (approx.)		g	22

Part No.	AL-value (nH/N ²)	Core loss (W) at 100°C 100kHz, 200mT	Calculated output power (forward converter mode)
PC40EI28-Z	4300±25% (1kHz, 0.5mA)* 6060 min. (100kHz, 200mT)	1.65 max.	107W (100kHz)

* Coil: ø0.35 2UEW 100Ts

NI limit vs. AL-value for PC40EI28 gapped core (Typical)

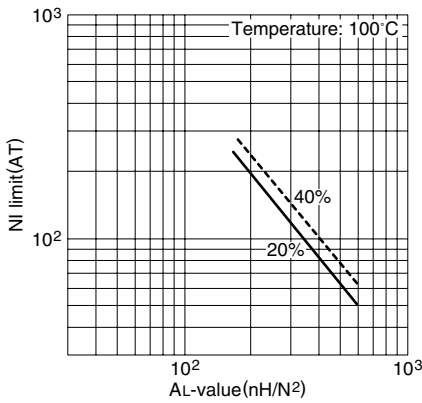

Note: NI limit shows the point where the exciting current is 20% and 40% away from its extended linear part.

AL-value vs. Air gap length for PC40EI28 core (Typical)

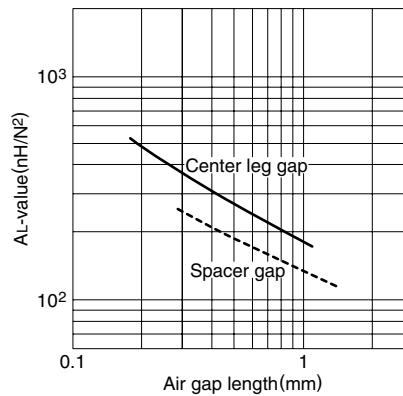

Measuring conditions • Coil: ø0.35 2UEW 100Ts
• Frequency: 1kHz
• Level: 0.5mA

Temperature rise vs. Total loss for EI28 core (Typical) (Ambient temperature: 25°C)

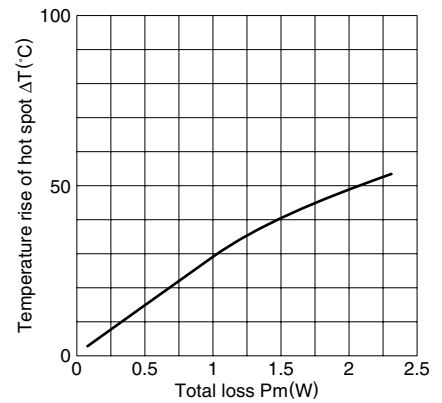

Note: The temperature rise is measured in the room whose temperature and humidity are fixed to 25°C and 45%(%)RH, respectively. (approx. 400×300×300cm)

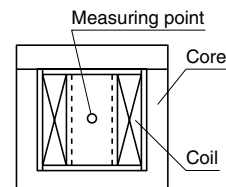

Ferrite

For Switching Power Supplies

Technical Data

EI Series EI30 Cores

JIS FEI 30

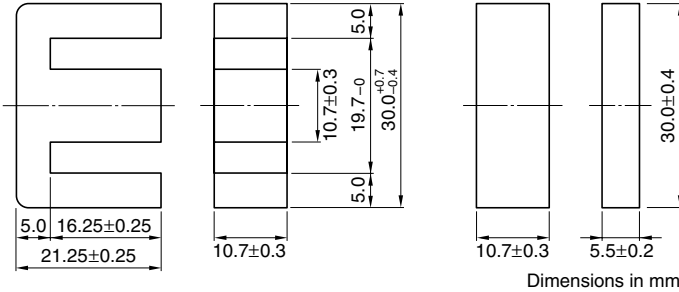

Parameter

Core factor	C1	mm ⁻¹	0.522
Effective magnetic path length	ℓ _e	mm	58.0
Effective cross-sectional area	A _e	mm ²	111
Effective core volume	V _e	mm ³	6440
Cross-sectional center leg area	A _{cp}	mm ²	114
Minimum cross-sectional area	A _{cp min.}	mm ²	108
Cross-sectional winding area of core	A _{cw}	mm ²	75.6
Weight (approx.)		g	34

Part No.	AL-value (nH/N ²)	Core loss (W) at 100°C 100kHz, 200mT	Calculated output power (forward converter mode)
PC40EI30-Z	4690±25% (1kHz, 0.5mA)* 6500 min. (100kHz, 200mT)	3.1 max.	155W (100kHz)

* Coil: ø0.35 2UEW 100Ts

NI limit vs. AL-value for PC40EI30 gapped core (Typical)

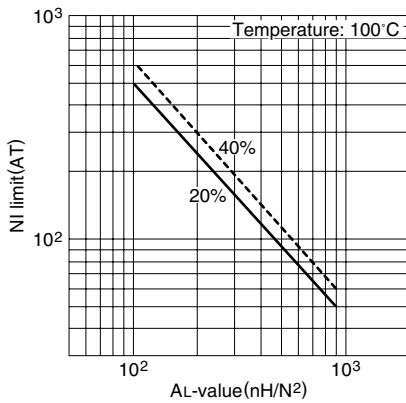

Note: NI limit shows the point where the exciting current is 20% and 40% away from its extended linear part.

AL-value vs. Air gap length for PC40EI30 core (Typical)

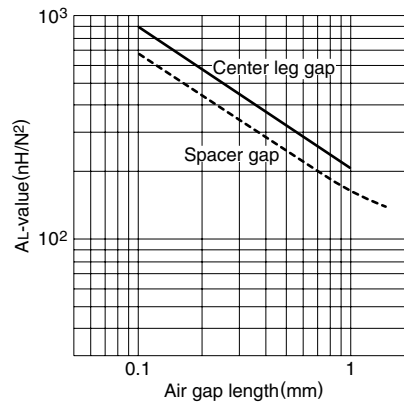

Measuring conditions • Coil: ø0.35 2UEW 100Ts
• Frequency: 1kHz
• Level: 0.5mA

Temperature rise vs. Total loss for EI30 core (Typical) (Ambient temperature: 25°C)

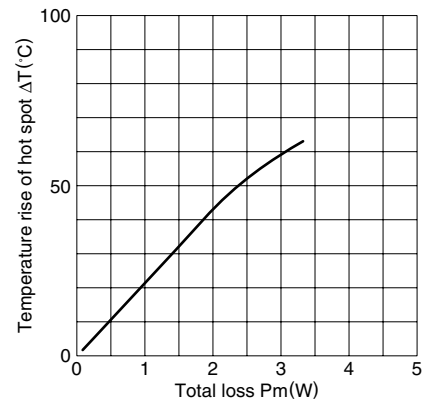

Note: The temperature rise is measured in the room whose temperature and humidity are fixed to 25°C and 45%RH, respectively. (approx. 400×300×300cm)

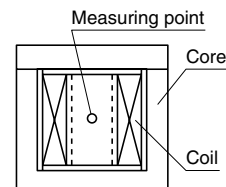

Ferrite

For Switching Power Supplies

Technical Data

EI Series EI33/29/13 Cores

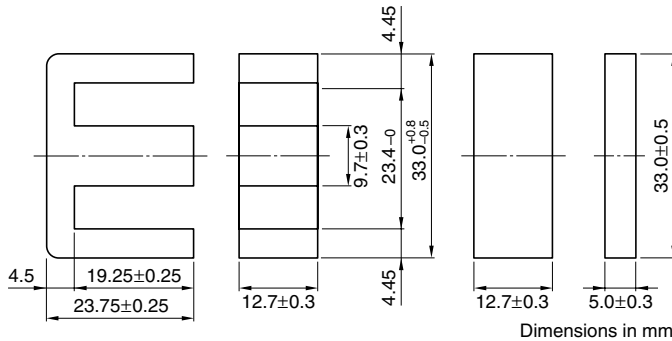

Parameter

Core factor	C1	mm ⁻¹	0.567
Effective magnetic path length	ℓ _e	mm	67.5
Effective cross-sectional area	A _e	mm ²	119
Effective core volume	V _e	mm ³	8030
Cross-sectional center leg area	A _{cp}	mm ²	123
Minimum cross-sectional area	A _{cp min.}	mm ²	117
Cross-sectional winding area of core	A _{cw}	mm ²	138.6
Weight (approx.)		g	41

Part No.	AL-value (nH/N ²)	Core loss (W) at 100°C 100kHz, 200mT	Calculated output power (forward converter mode)
PC40EI33/29/13-Z	4400±25% (1kHz, 0.5mA)* 5980 min. (100kHz, 200mT)	3.5 max.	206W (100kHz)

* Coil: ø0.35 2UEW 100Ts

NI limit vs. AL-value for PC40EI33/29/13 gapped core (Typical)

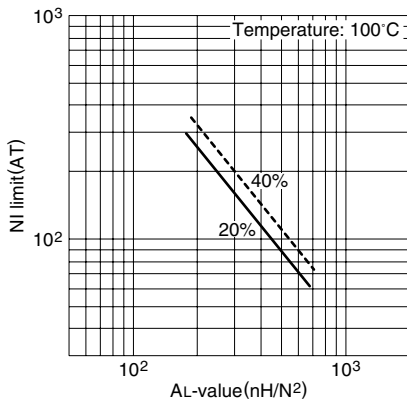

Note: NI limit shows the point where the exciting current is 20% and 40% away from its extended linear part.

AL-value vs. Air gap length for PC40EI33/29/13 core (Typical)

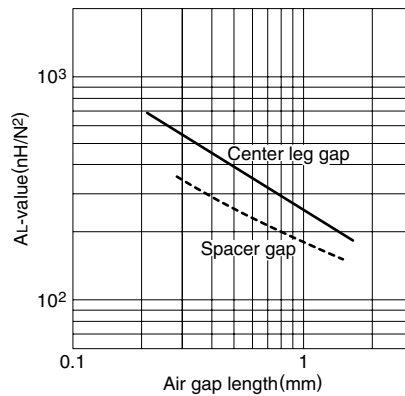

Measuring conditions • Coil: ø0.35 2UEW 100Ts
• Frequency: 1kHz
• Level: 0.5mA

Temperature rise vs. Total loss for EI33/29/13 core (Typical) (Ambient temperature: 25°C)

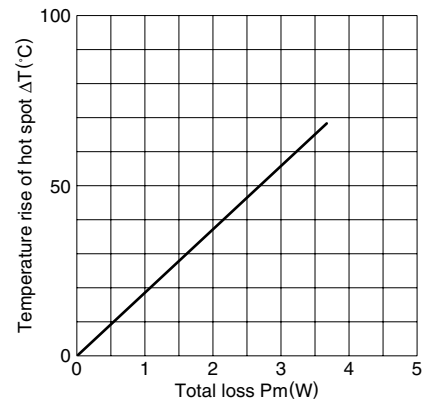

Note: The temperature rise is measured in the room whose temperature and humidity are fixed to 25°C and 45%RH, respectively. (approx. 400×300×300cm)

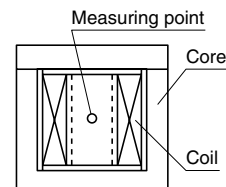

Ferrite

For Switching Power Supplies

Technical Data

EI Series EI35 Cores

JIS FEI 35

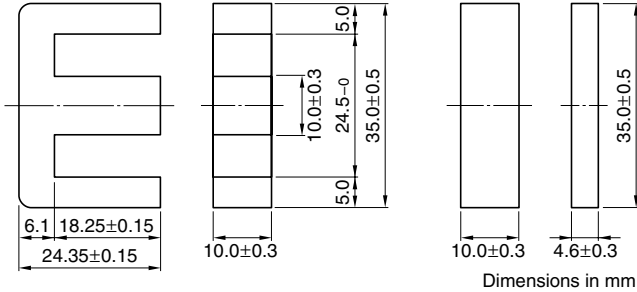

Parameter

Core factor	C1	mm ⁻¹	0.664
Effective magnetic path length	ℓ _e	mm	67.1
Effective cross-sectional area	A _e	mm ²	101
Effective core volume	V _e	mm ³	6780
Cross-sectional center leg area	A _{cp}	mm ²	100
Minimum cross-sectional area	A _{cp min.}	mm ²	94.1
Cross-sectional winding area of core	A _{cw}	mm ²	131.6
Weight (approx.)		g	36

Part No.	AL-value (nH/N ²)	Core loss (W) at 100°C	Calculated output power
		100kHz, 200mT	(forward converter mode)
PC40EI35-Z	3800±25% (1kHz, 0.5mA)* 5110 min. (100kHz, 200mT)	2.85 max.	218W (100kHz)

* Coil: ø0.35 2UEW 100Ts

NI limit vs. AL-value for PC40EI35 gapped core (Typical)

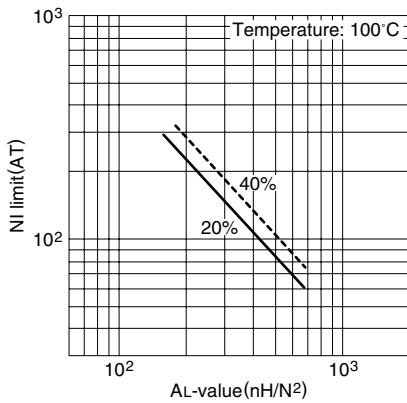

Note: NI limit shows the point where the exciting current is 20% and 40% away from its extended linear part.

AL-value vs. Air gap length for PC40EI35 core (Typical)

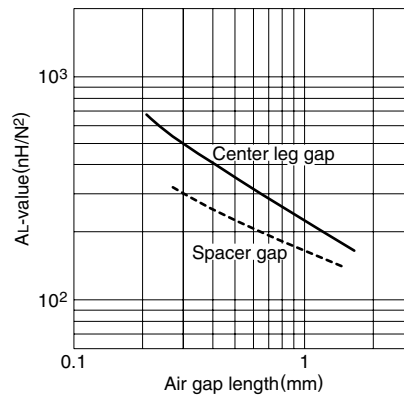

Measuring conditions • Coil: ø0.35 2UEW 100Ts
• Frequency: 1kHz
• Level: 0.5mA

Temperature rise vs. Total loss for EI35 core (Typical) (Ambient temperature: 25°C)

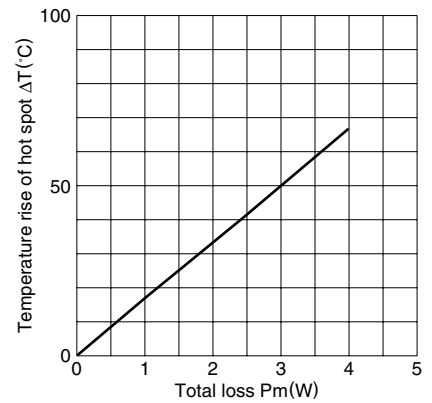

Note: The temperature rise is measured in the room whose temperature and humidity are fixed to 25°C and 45%RH, respectively. (approx. 400×300×300cm)

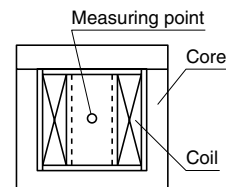

Ferrite

For Switching Power Supplies

Technical Data

EI Series EI40 Cores

JIS FEI 40

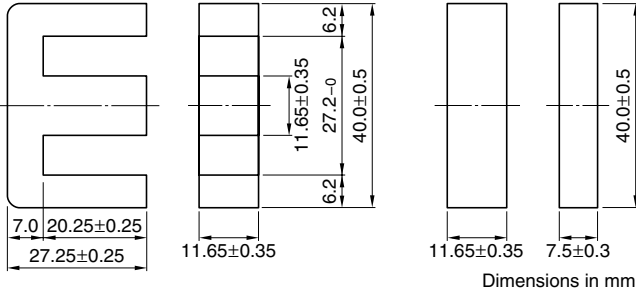

Parameter

Core factor	C1	mm ⁻¹	0.520
Effective magnetic path length	ℓ _e	mm	77.0
Effective cross-sectional area	A _e	mm ²	148
Effective core volume	V _e	mm ³	11400
Cross-sectional center leg area	A _{cp}	mm ²	136
Minimum cross-sectional area	A _{cp min.}	mm ²	128
Cross-sectional winding area of core	A _{cw}	mm ²	160.5
Weight (approx.)		g	60

Part No.	AL-value (nH/N ²)	Core loss (W) at 100°C	Calculated output power (forward converter mode)
		100kHz, 200mT	
PC40EI40-Z	4860±25% (1kHz, 0.5mA)* 6520 min. (100kHz, 200mT)	4.8 max.	348W (100kHz)

* Coil: ø0.35 2UEW 100Ts

NI limit vs. AL-value for PC40EI40 gapped core (Typical)

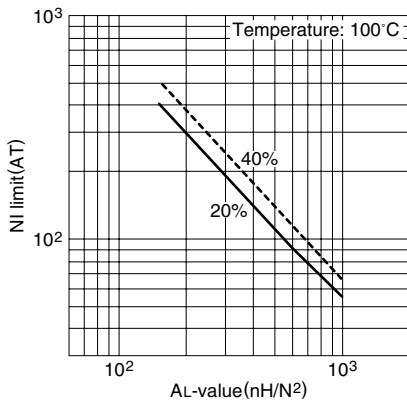

Note: NI limit shows the point where the exciting current is 20% and 40% away from its extended linear part.

AL-value vs. Air gap length for PC40EI40 core (Typical)

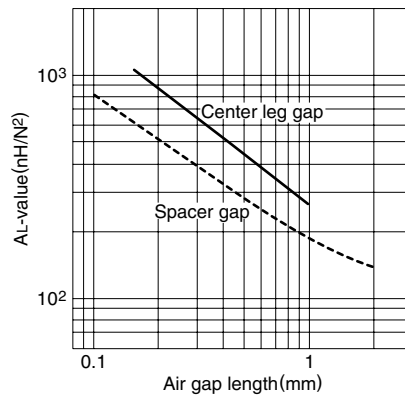

Measuring conditions • Coil: ø0.35 2UEW 100Ts
• Frequency: 1kHz
• Level: 0.5mA

Temperature rise vs. Total loss for EI40 core (Typical) (Ambient temperature: 25°C)

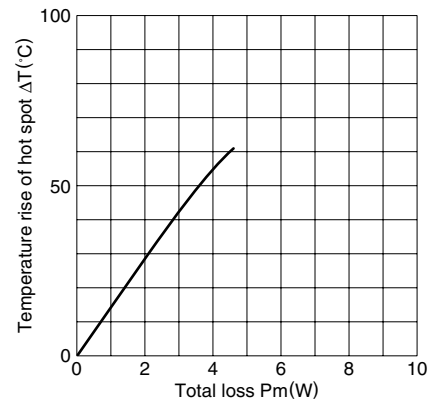

Note: The temperature rise is measured in the room whose temperature and humidity are fixed to 25°C and 45(%RH), respectively. (approx. 400×300×300cm)

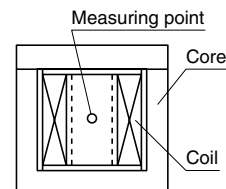

Ferrite

For Switching Power Supplies

Technical Data

EI Series EI50 Cores

JIS FEI 50

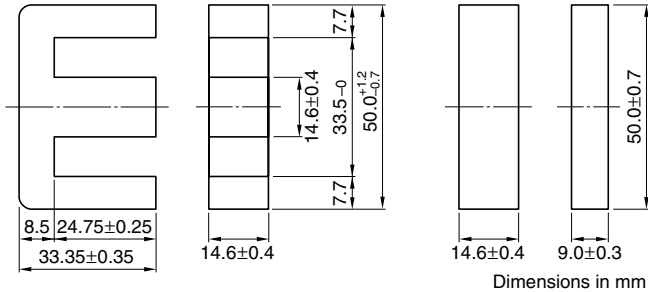

Parameter

Core factor	C1	mm ⁻¹	0.409
Effective magnetic path length	ℓ _e	mm	94.0
Effective cross-sectional area	A _e	mm ²	230
Effective core volume	V _e	mm ³	21620
Cross-sectional center leg area	A _{cp}	mm ²	213
Minimum cross-sectional area	A _{cp min.}	mm ²	202
Cross-sectional winding area of core	A _{cw}	mm ²	246.3
Weight (approx.)		g	115

Part No.	AL-value (nH/N ²)	Core loss (W) at 100°C	Calculated output power
		100kHz, 200mT	(forward converter mode)
PC40EI50-Z	6110±25% (1kHz, 0.5mA)* 8300 min. (100kHz, 200mT)	9.2 max.	508W (100kHz)

* Coil: ø0.35 2UEW 100Ts

NI limit vs. AL-value for PC40EI50 gapped core (Typical)

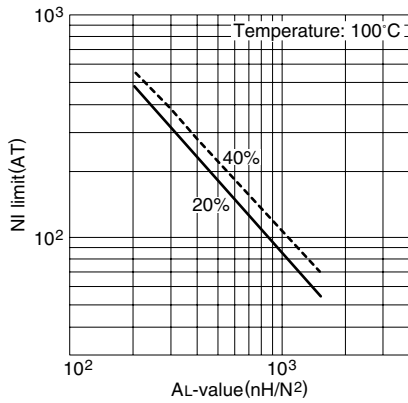

Note: NI limit shows the point where the exciting current is 20% and 40% away from its extended linear part.

AL-value vs. Air gap length for PC40EI50 core (Typical)

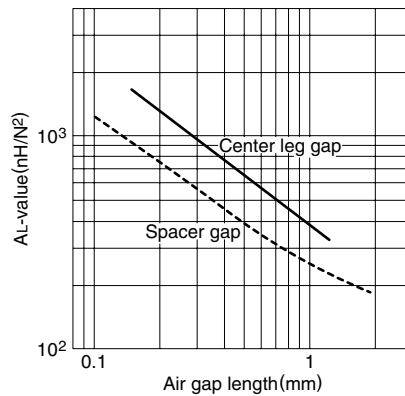

Measuring conditions • Coil: ø0.35 2UEW 100Ts
• Frequency: 1kHz
• Level: 0.5mA

Temperature rise vs. Total loss for EI50 core (Typical) (Ambient temperature: 25°C)

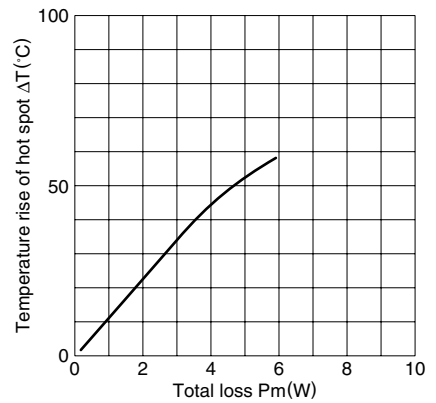

Note: The temperature rise is measured in the room whose temperature and humidity are fixed to 25°C and 45%RH, respectively. (approx. 400×300×300cm)

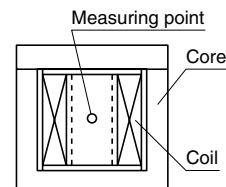

Ferrite

For Switching Power Supplies

Technical Data

EI Series EI60 Cores

JIS FEI 60

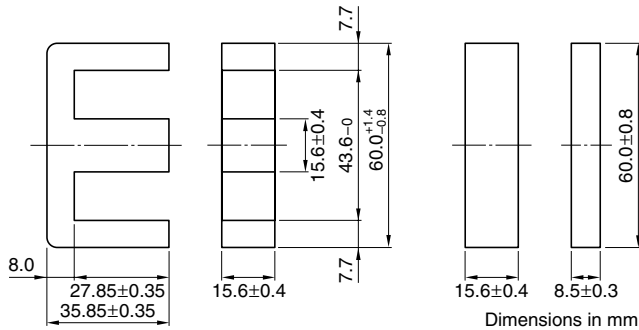

Parameter

Core factor	C1	mm ⁻¹	0.441
Effective magnetic path length	ℓ _e	mm	109
Effective cross-sectional area	A _e	mm ²	247
Effective core volume	V _e	mm ³	26900
Cross-sectional center leg area	A _{cp}	mm ²	243
Minimum cross-sectional area	A _{cp min.}	mm ²	231
Cross-sectional winding area of core	A _{cw}	mm ²	402.4
Weight (approx.)		g	139

Part No.	AL-value (nH/N ²)	Core loss (W) at 100°C 100kHz, 200mT	Calculated output power (forward converter mode)
PC40EI60-Z	5670±25% (1kHz, 0.5mA)* 7690 min. (100kHz, 200mT)	12.5 max.	618W (100kHz)

* Coil: ø0.35 2UEW 100Ts

NI limit vs. AL-value for PC40EI60 gapped core (Typical)

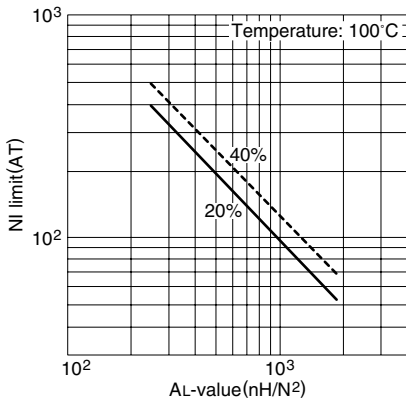

Note: NI limit shows the point where the exciting current is 20% and 40% away from its extended linear part.

AL-value vs. Air gap length for PC40EI60 core (Typical)

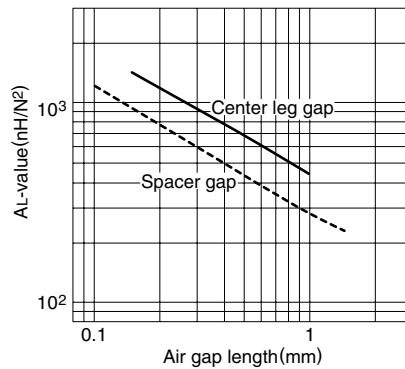

Measuring conditions • Coil: ø0.35 2UEW 100Ts
• Frequency: 1kHz
• Level: 0.5mA

Temperature rise vs. Total loss for EI60 core (Typical) (Ambient temperature: 25°C)

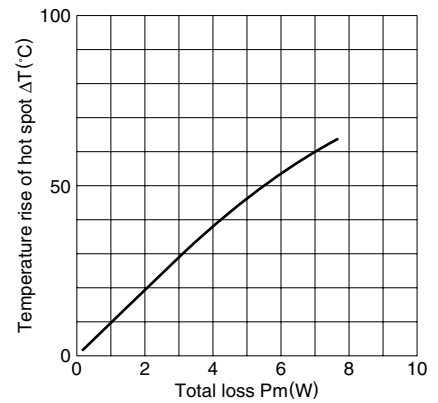

Note: The temperature rise is measured in the room whose temperature and humidity are fixed to 25°C and 45%RH, respectively. (approx. 400×300×300cm)

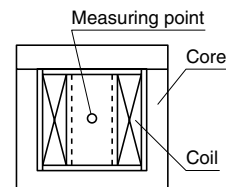

Ferrite

For Switching Power Supplies

Technical Data

EE Series EE10/11 Cores

JIS FEE 10.2

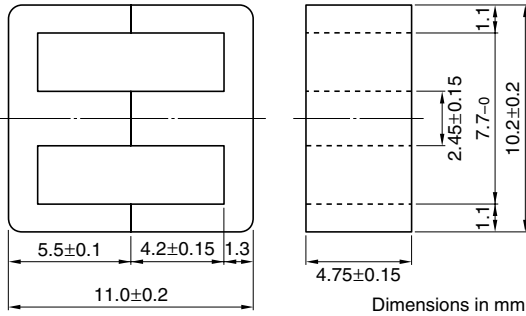

Parameter

Core factor	C1	mm ⁻¹	2.16
Effective magnetic path length	ℓ _e	mm	26.1
Effective cross-sectional area	A _e	mm ²	12.1
Effective core volume	V _e	mm ³	315
Cross-sectional center leg area	A _{cp}	mm ²	11.6
Minimum cross-sectional area	A _{cp min.}	mm ²	10.6
Cross-sectional winding area of core	A _{cw}	mm ²	23.3
Weight (approx.)		g	1.5

Part No.	AL-value (nH/N ²)	Core loss (W) at 100°C 100kHz, 200mT	Calculated output power (forward converter mode)
PC40EE10/11-Z	850±25% (1kHz, 0.5mA)* 1450 min. (100kHz, 200mT)	0.14 max.	9.4W (100kHz)

* Coil: ø0.18 2UEW 100Ts

NI limit vs. AL-value for PC40EE10/11 gapped core (Typical)

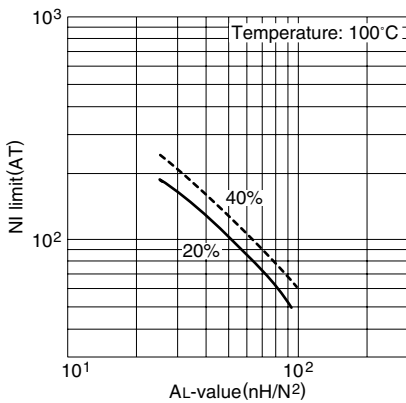

Note: NI limit shows the point where the exciting current is 20% and 40% away from its extended linear part.

AL-value vs. Air gap length for PC40EE10/11 core (Typical)

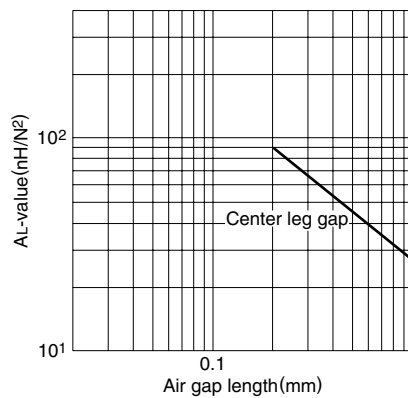

Measuring conditions • Coil: ø0.18 2UEW 100Ts
• Frequency: 1kHz
• Level: 0.5mA

Temperature rise vs. Total loss for EE10/11 core (Typical) (Ambient temperature: 25°C)

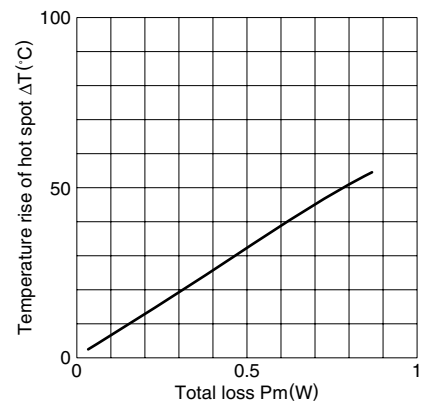

Note: The temperature rise is measured in the room whose temperature and humidity are fixed to 25°C and 45(%RH), respectively. (approx. 400×300×300cm)

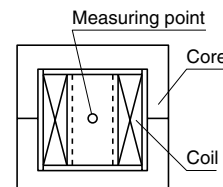

Ferrite

EE Series EE13 Cores

For Switching Power Supplies Technical Data

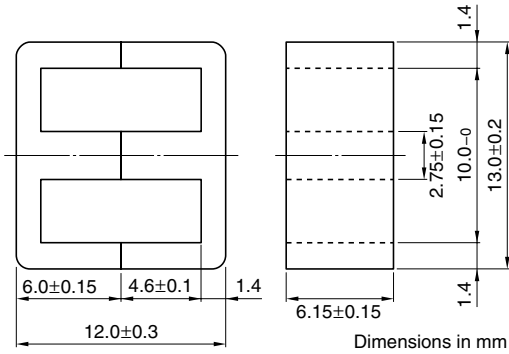

Parameter

Core factor	C1	mm ⁻¹	1.77
Effective magnetic path length	ℓ _e	mm	30.2
Effective cross-sectional area	A _e	mm ²	17.1
Effective core volume	V _e	mm ³	517
Cross-sectional center leg area	A _{cp}	mm ²	16.9
Minimum cross-sectional area	A _{cp min.}	mm ²	15.6
Cross-sectional winding area of core	A _{cw}	mm ²	34.3
Weight (approx.)		g	2.7

Part No.	AL-value (nH/N ²)	Core loss (W) at 100°C 100kHz, 200mT	Calculated output power (forward converter mode)
PC40EE13-Z	1130±25% (1kHz, 0.5mA)* 1770 min. (100kHz, 200mT)	0.235 max.	17W (100kHz)

* Coil: ø0.18 2UEW 100Ts

NI limit vs. AL-value for PC40EE13 gapped core (Typical)

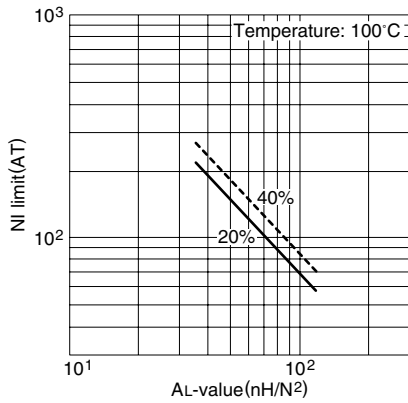

Note: NI limit shows the point where the exciting current is 20% and 40% away from its extended linear part.

AL-value vs. Air gap length for PC40EE13 core (Typical)

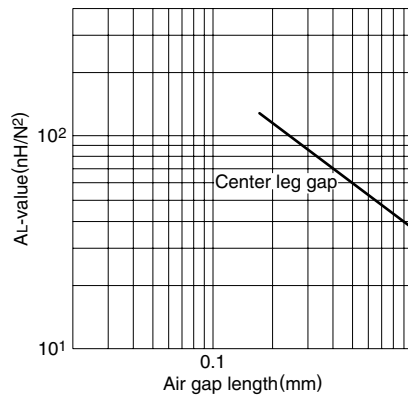

Measuring conditions • Coil: ø0.18 2UEW 100Ts
• Frequency: 1kHz
• Level: 0.5mA

Temperature rise vs. Total loss for EE13 core (Typical) (Ambient temperature: 25°C)

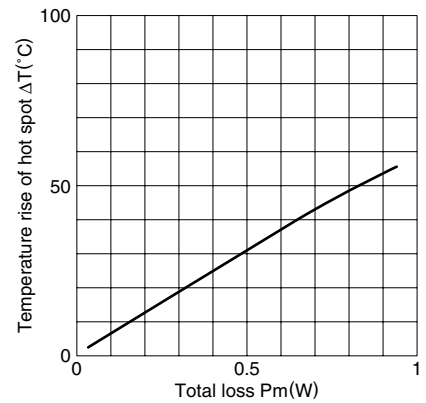

Note: The temperature rise is measured in the room whose temperature and humidity are fixed to 25°C and 45(%RH), respectively. (approx. 400×300×300cm)

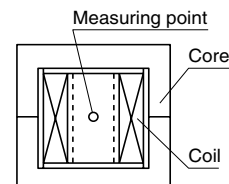

Ferrite

For Switching Power Supplies

Technical Data

EE Series SEE16 Cores

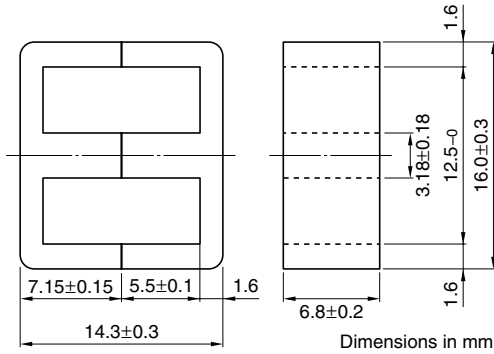

Parameter

Core factor	C1	mm ⁻¹	1.69
Effective magnetic path length	ℓ _e	mm	36.6
Effective cross-sectional area	A _e	mm ²	21.7
Effective core volume	V _e	mm ³	795
Cross-sectional center leg area	A _{cp}	mm ²	21.6
Minimum cross-sectional area	A _{cp min.}	mm ²	19.8
Cross-sectional winding area of core	A _{cw}	mm ²	52.9
Weight (approx.)		g	4.1

Part No.	AL-value (nH/N ²)	Core loss (W) at 100°C 100kHz, 200mT	Calculated output power (forward converter mode)
PC40SEE16-Z	1240±25% (1kHz, 0.5mA)* 1850 min. (100kHz, 200mT)	0.37 max.	32W (100kHz)

* Coil: ø0.23 2UEW 100Ts

NI limit vs. AL-value for PC40SEE16 gapped core (Typical)

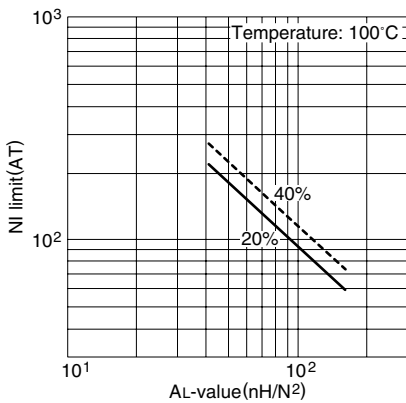

Note: NI limit shows the point where the exciting current is 20% and 40% away from its extended linear part.

AL-value vs. Air gap length for PC40SEE16 core (Typical)

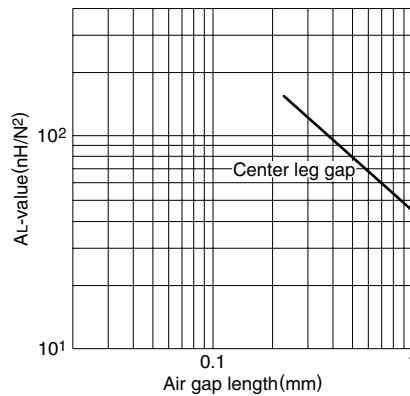

Measuring conditions • Coil: ø0.23 2UEW 100Ts
• Frequency: 1kHz
• Level: 0.5mA

Temperature rise vs. Total loss for SEE16 core (Typical) (Ambient temperature: 25°C)

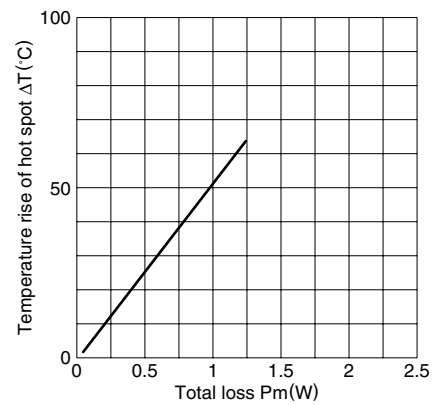

Note: The temperature rise is measured in the room whose temperature and humidity are fixed to 25°C and 45%(%)RH, respectively. (approx. 400×300×300cm)

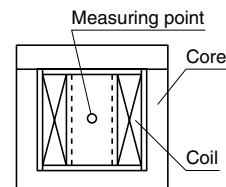

Ferrite

For Switching Power Supplies

Technical Data

EE Series EE20/20/5 Cores

DIN 41295

Based on DIN 41295.

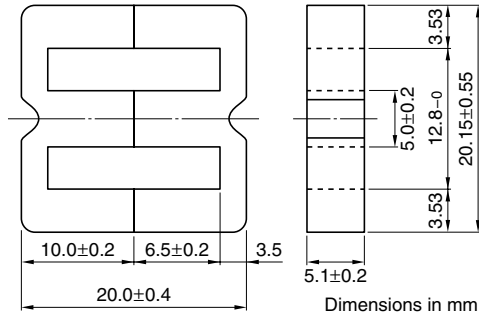

Parameter

Core factor	C1	mm ⁻¹	1.38
Effective magnetic path length	ℓ _e	mm	43.0
Effective cross-sectional area	A _e	mm ²	31.0
Effective core volume	V _e	mm ³	1340
Cross-sectional center leg area	A _{cp}	mm ²	25.5
Minimum cross-sectional area	A _{cp min.}	mm ²	23.5
Cross-sectional winding area of core	A _{cw}	mm ²	41.3
Weight (approx.)		g	7.5

Part No.	AL-value (nH/N ²)	Core loss (W) at 100°C 100kHz, 200mT	Calculated output power (forward converter mode)
PC40EE20/20/5-Z	1400±25% (1kHz, 0.5mA)* 2270 min. (100kHz, 200mT)	0.51 max.	41W (100kHz)

* Coil: ø0.23 2UEW 100Ts

NI limit vs. AL-value for PC40EE20/20/5 gapped core (Typical)

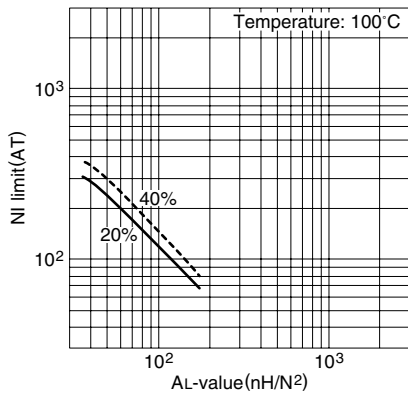

Note: NI limit shows the point where the exciting current is 20% and 40% away from its extended linear part.

AL-value vs. Air gap length for PC40EE20/20/5 core (Typical)

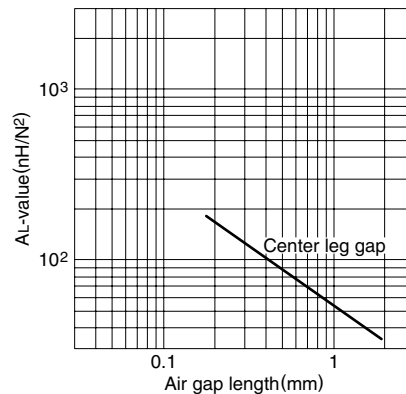

Measuring conditions • Coil: ø0.23 2UEW 100Ts
• Frequency: 1kHz
• Level: 0.5mA

Temperature rise vs. Total loss for EE20/20/5 core (Typical) (Ambient temperature: 25°C)

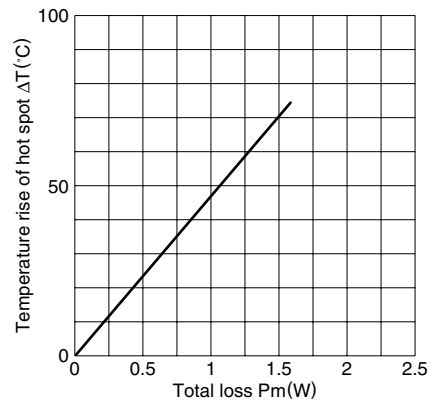

Note: The temperature rise is measured in the room whose temperature and humidity are fixed to 25°C and 45(%RH), respectively. (approx. 400×300×300cm)

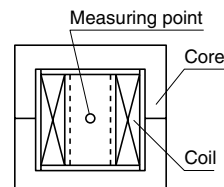

Ferrite

For Switching Power Supplies

Technical Data

EE Series EE25/19 Cores

Based on standard U. S. lamination size.

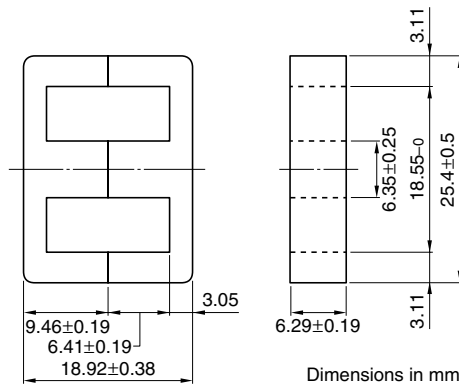

Parameter

Core factor	C1	mm ⁻¹	1.22
Effective magnetic path length	ℓ _e	mm	48.7
Effective cross-sectional area	A _e	mm ²	40.0
Effective core volume	V _e	mm ³	1950
Cross-sectional center leg area	A _{cp}	mm ²	39.9
Minimum cross-sectional area	A _{cp min.}	mm ²	37.2
Cross-sectional winding area of core	A _{cw}	mm ²	79.0
Weight (approx.)		g	9.1

Part No.	AL-value (nH/N ²)	Core loss (W) at 100°C	Calculated output power
		100kHz, 200mT	(forward converter mode)
PC40EE25/19-Z	2000±25% (1kHz, 0.5mA)* 2570 min. (100kHz, 200mT)	0.86 max.	70W (100kHz)

* Coil: ø0.23 2UEW 100Ts

NI limit vs. AL-value for PC40EE25/19 gapped core (Typical)

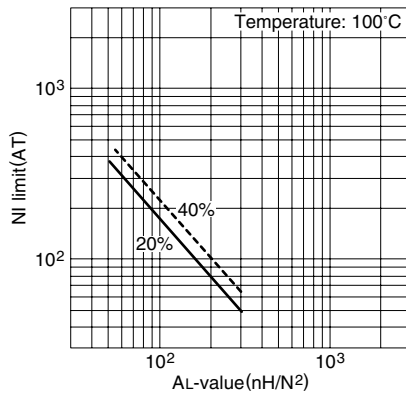

Note: NI limit shows the point where the exciting current is 20% and 40% away from its extended linear part.

AL-value vs. Air gap length for PC40EE25/19 core (Typical)

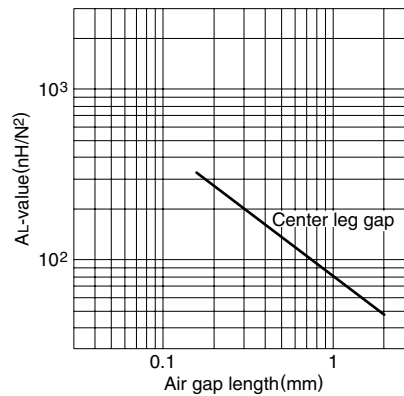

Measuring conditions • Coil: ø0.23 2UEW 100Ts
• Frequency: 1kHz
• Level: 0.5mA

Temperature rise vs. Total loss for EE25/19 core (Typical) (Ambient temperature: 25°C)

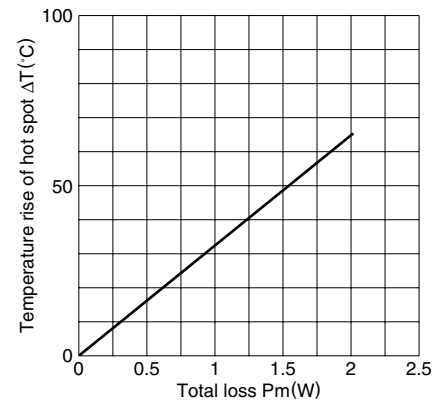

Note: The temperature rise is measured in the room whose temperature and humidity are fixed to 25°C and 45(%RH), respectively. (approx. 400×300×300cm)

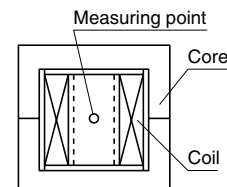

Ferrite

For Switching Power Supplies

Technical Data

EE Series EE30/30/7 Cores

DIN 41295

Based on DIN 41295

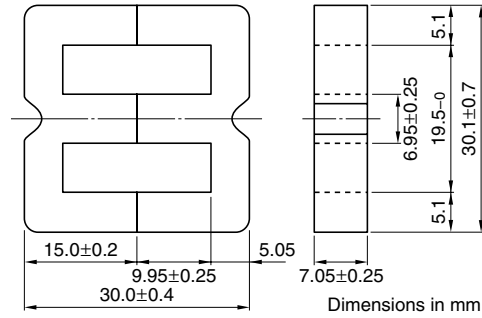

Parameter

Core factor	C1	mm ⁻¹	1.12
Effective magnetic path length	ℓ _e	mm	66.9
Effective cross-sectional area	A _e	mm ²	59.7
Effective core volume	V _e	mm ³	4000
Cross-sectional center leg area	A _{cp}	mm ²	49.0
Minimum cross-sectional area	A _{cp min.}	mm ²	45.6
Cross-sectional winding area of core	A _{cw}	mm ²	129
Weight (approx.)		g	22

Part No.	AL-value (nH/N ²)	Core loss (W) at 100°C 100kHz, 200mT	Calculated output power (forward converter mode)
PC40EE30/30/7-Z	2100±25% (1kHz, 0.5mA)* 3030 min. (100kHz, 200mT)	1.51 max.	133W (100kHz)

* Coil: ø0.35 2UEW 100Ts

NI limit vs. AL-value for PC40EE30/30/7 gapped core (Typical)

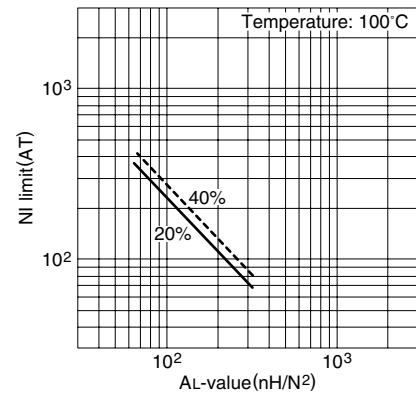

Note: NI limit shows the point where the exciting current is 20% and 40% away from its extended linear part.

AL-value vs. Air gap length for PC40EE30/30/7 core (Typical)

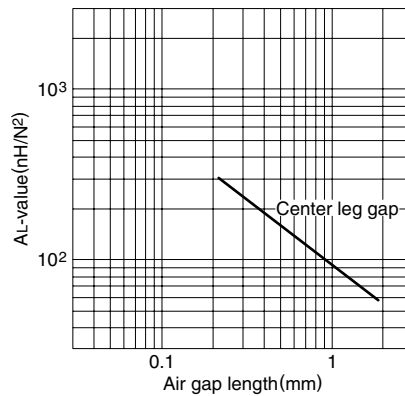

Measuring conditions • Coil: ø0.35 2UEW 100Ts
• Frequency: 1kHz
• Level: 0.5mA

Temperature rise vs. Total loss for EE30/30/7 core (Typical) (Ambient temperature: 25°C)

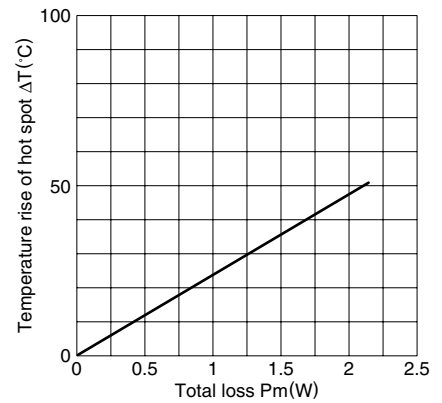

Note: The temperature rise is measured in the room whose temperature and humidity are fixed to 25°C and 45(%RH), respectively. (approx. 400×300×300cm)

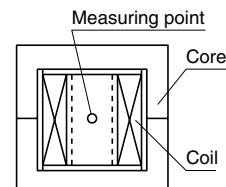

Ferrite

For Switching Power Supplies

Technical Data

EE Series EE42/42/15 Cores

DIN 41295

Based on DIN 41295

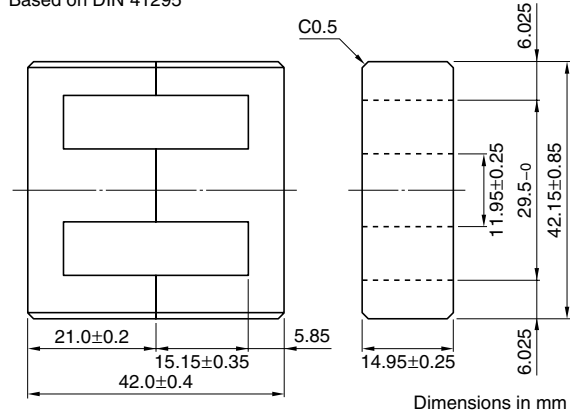

Parameter

Core factor	C1	mm ⁻¹	0.547
Effective magnetic path length	ℓ _e	mm	97.4
Effective cross-sectional area	A _e	mm ²	178
Effective core volume	V _e	mm ³	17400
Cross-sectional center leg area	A _{cp}	mm ²	179
Minimum cross-sectional area	A _{cp min.}	mm ²	172
Cross-sectional winding area of core	A _{cw}	mm ²	275
Weight (approx.)		g	80

Part No.	AL-value (nH/N ²)	Core loss (W) at 100°C 100kHz, 200mT	Calculated output power (forward converter mode)
PC40EE42/42/15-Z	4700±25% (1kHz, 0.5mA)* 7050 min. (100kHz, 200mT)	8.0 max.	419W (100kHz)

* Coil: ø0.35 2UEW 100Ts

NI limit vs. AL-value for PC40EE42/42/15 gapped core (Typical)

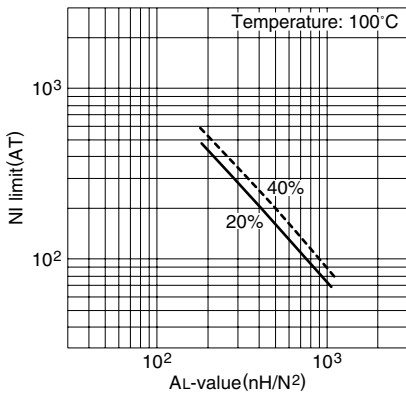

Note: NI limit shows the point where the exciting current is 20% and 40% away from its extended linear part.

AL-value vs. Air gap length for PC40EE42/42/15 core (Typical)

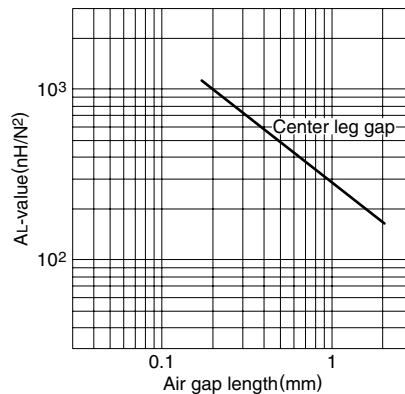

Measuring conditions • Coil: ø0.35 2UEW 100Ts
• Frequency: 1kHz
• Level: 0.5mA

Temperature rise vs. Total loss for EE42/42/15 core (Typical) (Ambient temperature: 25°C)

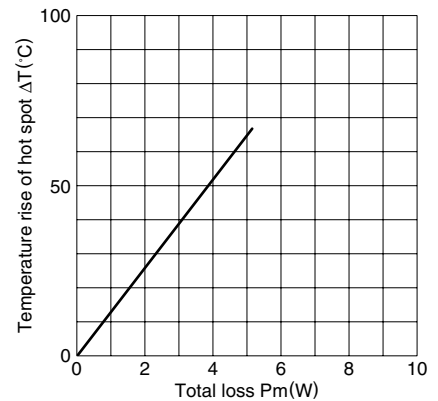

Note: The temperature rise is measured in the room whose temperature and humidity are fixed to 25°C and 45%RH, respectively. (approx. 400×300×300cm)

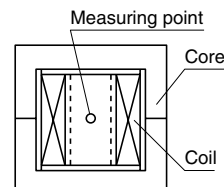

Ferrite

For Switching Power Supplies

Technical Data

EE Series EE55/55/21 Cores

DIN 41295

Based on DIN 41295

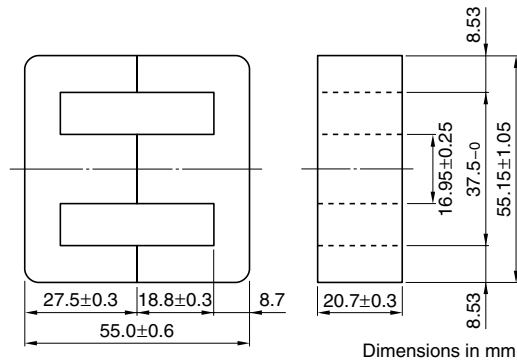

Parameter

Core factor	C1	mm ⁻¹	0.348
Effective magnetic path length	ℓ _e	mm	123
Effective cross-sectional area	A _e	mm ²	354
Effective core volume	V _e	mm ³	43700
Cross-sectional center leg area	A _{cp}	mm ²	351
Minimum cross-sectional area	A _{cp min.}	mm ²	341
Cross-sectional winding area of core	A _{cw}	mm ²	397
Weight (approx.)		g	234

Part No.	AL-value (nH/N ²)	Core loss (W) at 100°C 100kHz, 200mT	Calculated output power (forward converter mode)
PC40EE55/55/21-Z	7100±25% (1kHz, 0.5mA)* 10830 min. (100kHz, 200mT)	11.0 max.	814W (100kHz)

* Coil: ø0.35 2UEW 100Ts

NI limit vs. AL-value for PC40EE55/55/21 gapped core (Typical)

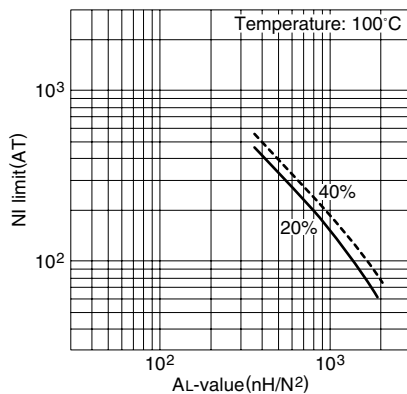

Note: NI limit shows the point where the exciting current is 20% and 40% away from its extended linear part.

AL-value vs. Air gap length for PC40EE55/55/21 core (Typical)

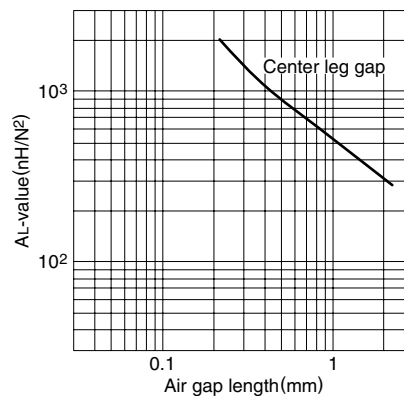

Measuring conditions • Coil: ø0.35 2UEW 100Ts
• Frequency: 1kHz
• Level: 0.5mA

Temperature rise vs. Total loss for EE55/55/21 core (Typical) (Ambient temperature: 25°C)

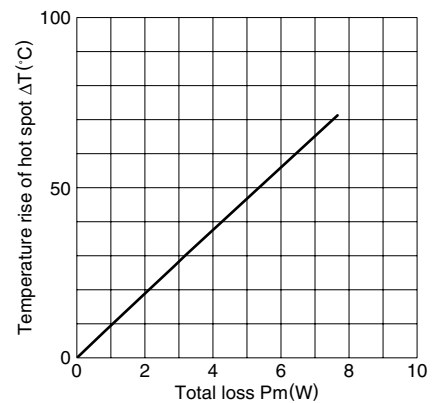

Note: The temperature rise is measured in the room whose temperature and humidity are fixed to 25°C and 45(%RH), respectively. (approx. 400×300×300cm)

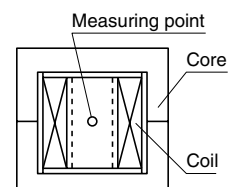

Ferrite

For Switching Power Supplies

Technical Data

EE Series EE50.3/51/6 Cores

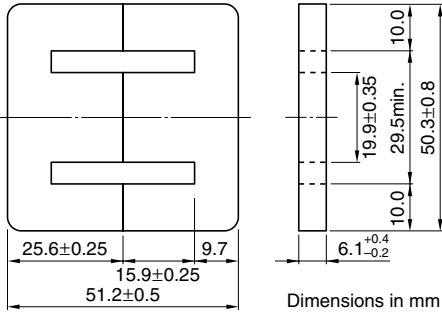

Parameter

Core factor	C1	mm ⁻¹	0.868
Effective magnetic path length	ℓ _e	mm	105
Effective cross-sectional area	A _e	mm ²	121
Effective core volume	V _e	mm ³	12700
Cross-sectional center leg area	A _{cp}	mm ²	121.39
Minimum cross-sectional area	A _{cp min.}	mm ²	115.345
Cross-sectional winding area of core	A _{cw}	mm ²	163.3
Weight (approx.)		g	34

Part No.	AL-value (nH/N ²)	Core loss (W) at 100°C 100kHz, 200mT	Calculated output power (forward converter mode)
PC40EE50.3/51/6-Z	2900±25% (1kHz, 0.5mA)* 3900 min. (100kHz, 200mT)	5.83 max.	213W (100kHz)

* Coil: ø0.23 2UEW 100Ts

NI limit vs. AL-value for PC40EE50.3/51/6 gapped core (Typical)

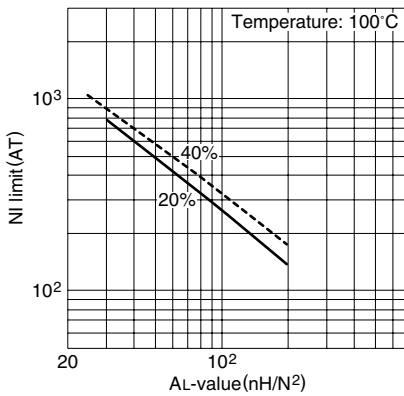

Note: NI limit shows the point where the exciting current is 20% and 40% away from its extended linear part.

AL-value vs. Air gap length for PC40EE50.3/51/6 core (Typical)

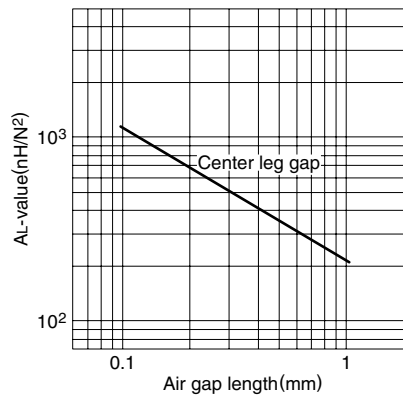

Measuring conditions • Coil: ø0.23 2UEW 100Ts
• Frequency: 1kHz
• Level: 0.5mA

Temperature rise vs. Total loss for EE50.3/51/6 core (Typical) (Ambient temperature: 25°C)

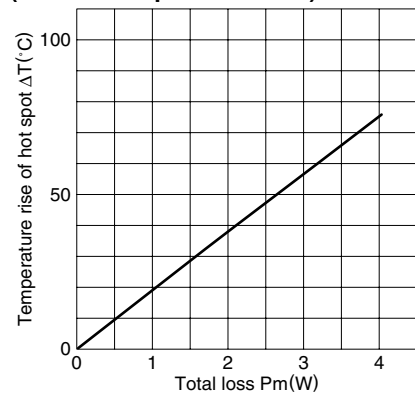

Note: The temperature rise is measured in the room whose temperature and humidity are fixed to 25°C and 45%RH, respectively. (approx. 400×300×300cm)

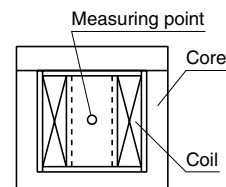

Ferrite

For Switching Power Supplies

Technical Data

EE Series EE62.3/62/6 Cores

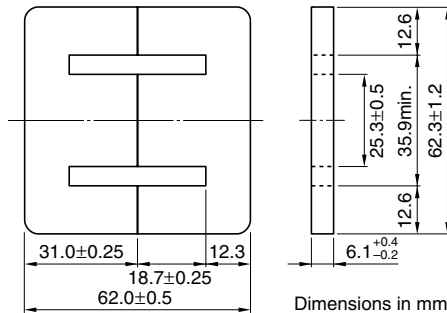

Parameter

Core factor	C1	mm ⁻¹	0.823
Effective magnetic path length	ℓ _e	mm	126
Effective cross-sectional area	A _e	mm ²	153
Effective core volume	V _e	mm ³	19300
Cross-sectional center leg area	A _{cp}	mm ²	154
Minimum cross-sectional area	A _{cp min.}	mm ²	146.3
Cross-sectional winding area of core	A _{cw}	mm ²	202
Weight (approx.)		g	52

Part No.	AL-value (nH/N ²)	Core loss (W) at 100°C 100kHz, 200mT	Calculated output power (forward converter mode)
PC40EE62.3/62/6-Z	3100±25% (1kHz, 0.5mA)* 4100 min. (100kHz, 200mT)	8.85 max.	250W (100kHz)

* Coil: ø0.35 2UEW 100Ts

NI limit vs. AL-value for PC40EE62.3/62/6 gapped core (Typical)

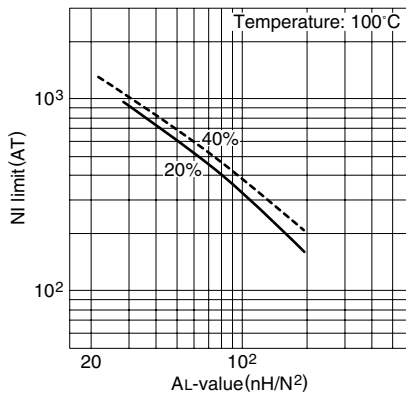

Note: NI limit shows the point where the exciting current is 20% and 40% away from its extended linear part.

AL-value vs. Air gap length for PC40EE62.3/62/6 core (Typical)

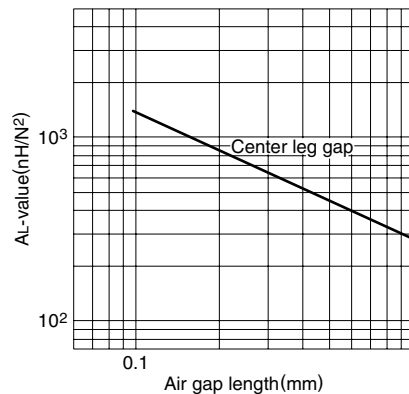

Measuring conditions • Coil: ø0.35 2UEW 100Ts
• Frequency: 1kHz
• Level: 0.5mA

Temperature rise vs. Total loss for EE62.3/62/6 core (Typical) (Ambient temperature: 25°C)

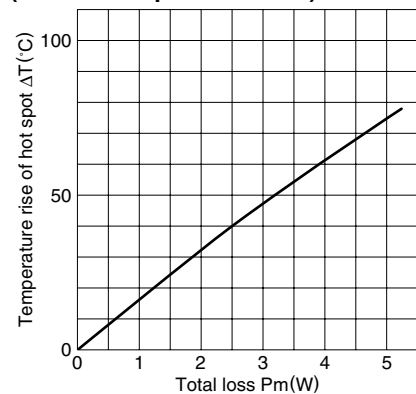

Note: The temperature rise is measured in the room whose temperature and humidity are fixed to 25°C and 45%RH, respectively. (approx. 400×300×300cm)

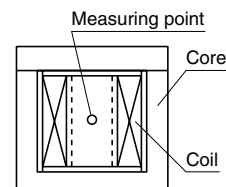

Ferrite

For Switching Power Supplies

Technical Data

EER Series EER25.5 Cores

JIS FEER 25.5A

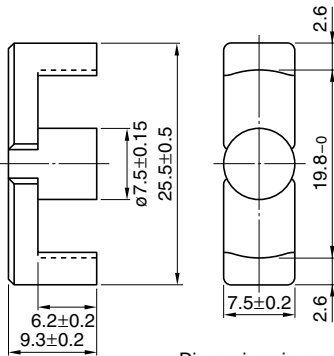

Parameter

Core factor	C1	mm ⁻¹	1.08
Effective magnetic path length	ℓ_e	mm	48.2
Effective cross-sectional area	A_e	mm ²	44.8
Effective core volume	V_e	mm ³	2160
Cross-sectional center pole area	A_{cp}	mm ²	44.2
Minimum cross-sectional center pole area	$A_{cp \text{ min.}}$	mm ²	42.4
Cross-sectional winding area of core	A_{cw}	mm ²	79.4
Weight (approx.)		g	11

Part No.	AL-value (nH/N ²)	Core loss (W) at 100°C	Calculated output power
		100kHz, 200mT	(forward converter mode)
PC40EER25.5-Z	1920±25% (1kHz, 0.5mA)* 2910 min. (100kHz, 200mT)	0.98 max.	87W (100kHz)

* Coil: $\phi 0.35$ 2UEW 100Ts

NI limit vs. AL-value for PC40EER25.5 gapped core (Typical)

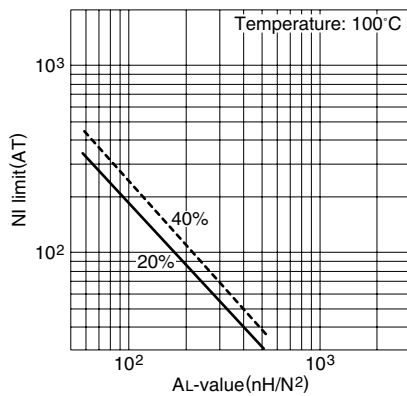

Note: NI limit shows the point where the exciting current is 20% and 40% away from its extended linear part.

AL-value vs. Air gap length for PC40EER25.5 core (Typical)

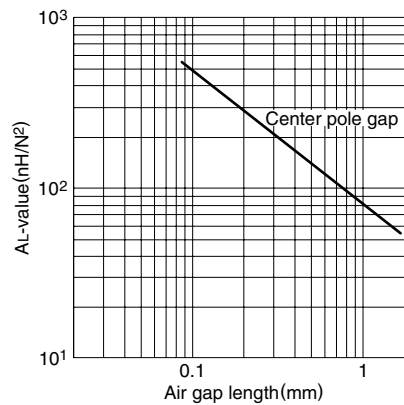

Measuring conditions • Coil: $\phi 0.35$ 2UEW 100Ts
• Frequency: 1kHz
• Level: 0.5mA

Temperature rise vs. Total loss for EER25.5 core (Typical) (Ambient temperature: 25°C)

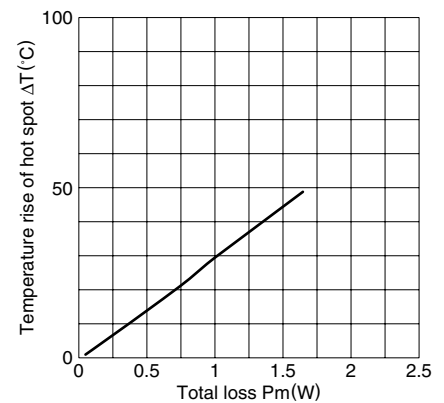

Note: The temperature rise is measured in the room whose temperature and humidity are fixed to 25°C and 45%RH, respectively. (approx. 400×300×300cm)

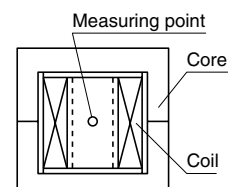

Ferrite

For Switching Power Supplies

Technical Data

EER Series EER28 Cores

JIS FEER 28.5A

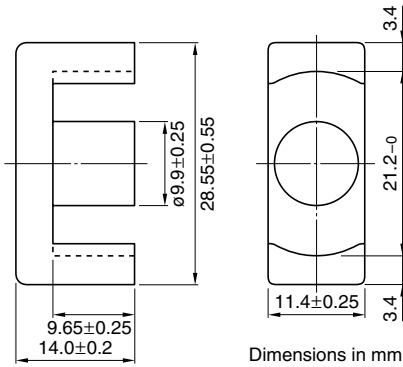

Parameter

Core factor	C1	mm ⁻¹	0.78
Effective magnetic path length	ℓ _e	mm	64.0
Effective cross-sectional area	A _e	mm ²	82.1
Effective core volume	V _e	mm ³	5250
Cross-sectional center pole area	A _{cp}	mm ²	77.0
Minimum cross-sectional center pole area	A _{cp min.}	mm ²	73.1
Cross-sectional winding area of core	A _{cw}	mm ²	114
Weight (approx.)		g	28

Part No.	AL-value (nH/N ²)	Core loss (W) at 100°C 100kHz, 200mT	Calculated output power (forward converter mode)
PC40EER28-Z	2870±25% (1kHz, 0.5mA)* 4350 min. (100kHz, 200mT)	2.3 max.	203W (100kHz)

* Coil: ø0.35 2UEW 100Ts

NI limit vs. AL-value for PC40EER28 gapped core (Typical)

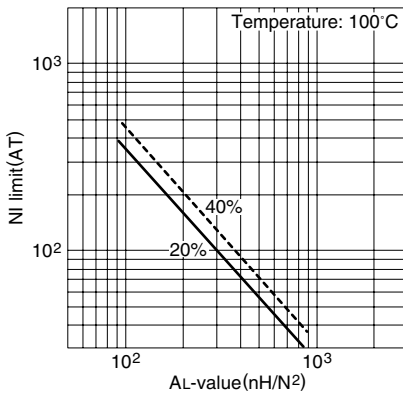

Note: NI limit shows the point where the exciting current is 20% and 40% away from its extended linear part.

AL-value vs. Air gap length for PC40EER28 core (Typical)

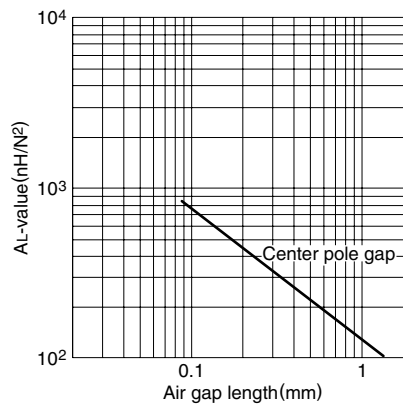

Measuring conditions • Coil: ø0.35 2UEW 100Ts
• Frequency: 1kHz
• Level: 0.5mA

Temperature rise vs. Total loss for EER28 core (Typical) (Ambient temperature: 25°C)

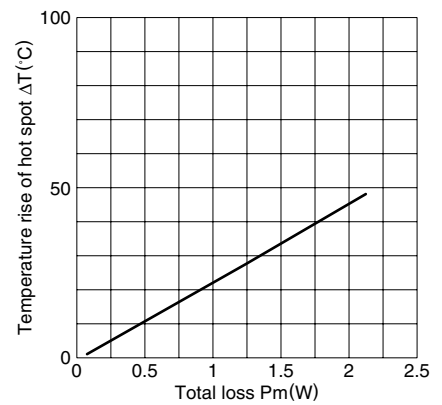

Note: The temperature rise is measured in the room whose temperature and humidity are fixed to 25°C and 45(%RH), respectively. (approx. 400×300×300cm)

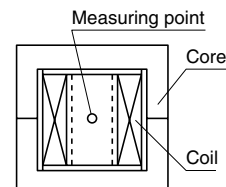

Ferrite

For Switching Power Supplies

Technical Data

EER Series EER28L Cores

JIS FEER 28.5B

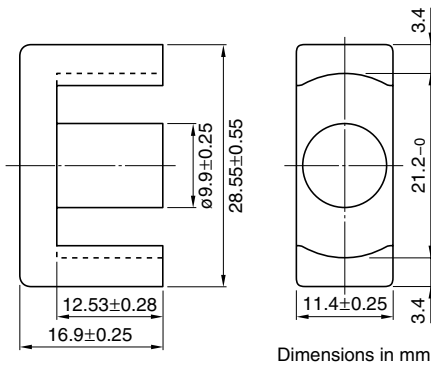

Parameter

Core factor	C1	mm ⁻¹	0.928
Effective magnetic path length	ℓ _e	mm	75.5
Effective cross-sectional area	A _e	mm ²	81.4
Effective core volume	V _e	mm ³	6150
Cross-sectional center pole area	A _{cp}	mm ²	77.0
Minimum cross-sectional center pole area	A _{cp min.}	mm ²	73.1
Cross-sectional winding area of core	A _{cw}	mm ²	148
Weight (approx.)		g	33

Part No.	AL-value (nH/N ²)	Core loss (W) at 100°C 100kHz, 200mT	Calculated output power (forward converter mode)
PC40EER28L-Z	2520±25% (1kHz, 0.5mA)* 3660 min. (100kHz, 200mT)	2.7 max.	228W (100kHz)

* Coil: ø0.35 2UEW 100Ts

NI limit vs. AL-value for PC40EER28L gapped core (Typical)

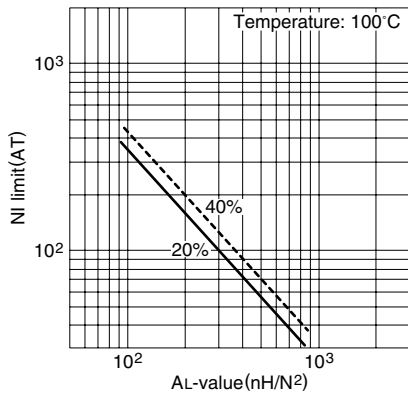

Note: NI limit shows the point where the exciting current is 20% and 40% away from its extended linear part.

AL-value vs. Air gap length for PC40EER28L core (Typical)

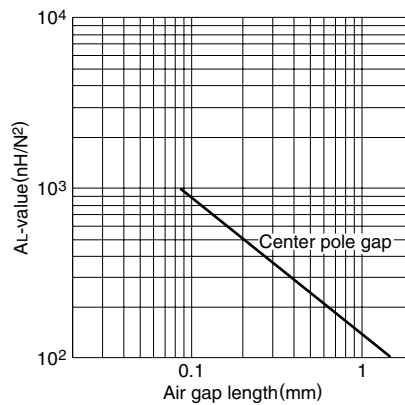

Measuring conditions • Coil: ø0.35 2UEW 100Ts
• Frequency: 1kHz
• Level: 0.5mA

Temperature rise vs. Total loss for EER28L core (Typical) (Ambient temperature: 25°C)

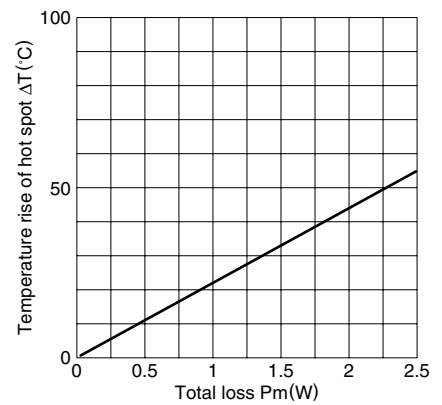

Note: The temperature rise is measured in the room whose temperature and humidity are fixed to 25°C and 45(%RH), respectively. (approx. 400×300×300cm)

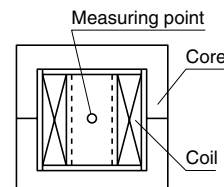

Ferrite

For Switching Power Supplies

Technical Data

EER Series EER35 Cores

JIS FEER 35A

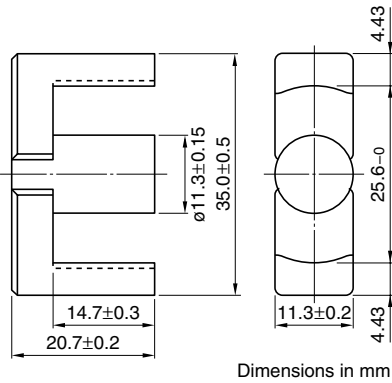

Parameter

Core factor	C1	mm ⁻¹	0.849
Effective magnetic path length	ℓ _e	mm	90.8
Effective cross-sectional area	A _e	mm ²	107
Effective core volume	V _e	mm ³	9720
Cross-sectional center pole area	A _{cp}	mm ²	100
Minimum cross-sectional center pole area	A _{cp min.}	mm ²	97.6
Cross-sectional winding area of core	A _{cw}	mm ²	218
Weight (approx.)		g	52

Part No.	AL-value (nH/N ²)	Core loss (W) at 100°C 100kHz, 200mT	Calculated output power (forward converter mode)
PC40EER35-Z	2770±25% (1kHz, 0.5mA)* 4000 min. (100kHz, 200mT)	4.2 max.	325W (100kHz)

* Coil: ø0.35 2UEW 100Ts

NI limit vs. AL-value for PC40EER35 gapped core (Typical)

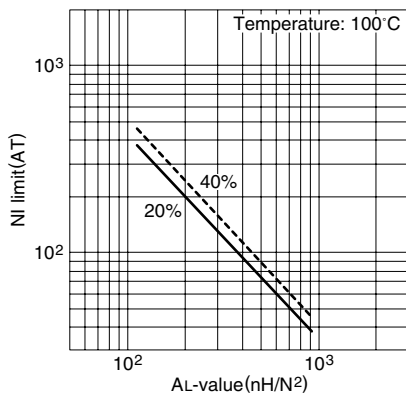

Note: NI limit shows the point where the exciting current is 20% and 40% away from its extended linear part.

AL-value vs. Air gap length for PC40EER35 core (Typical)

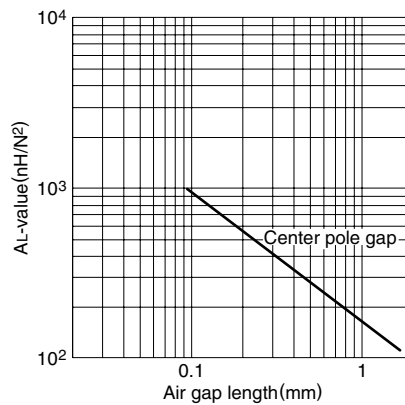

Measuring conditions • Coil: ø0.35 2UEW 100Ts
• Frequency: 1kHz
• Level: 0.5mA

Temperature rise vs. Total loss for EER35 core (Typical) (Ambient temperature: 25°C)

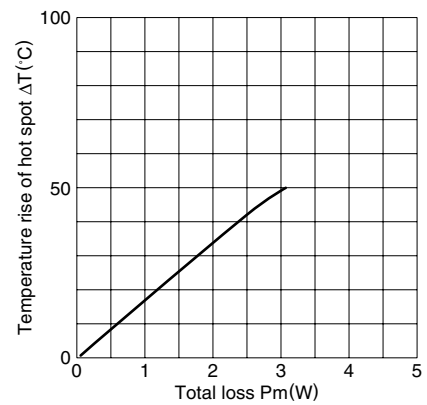

Note: The temperature rise is measured in the room whose temperature and humidity are fixed to 25°C and 45%RH, respectively. (approx. 400×300×300cm)

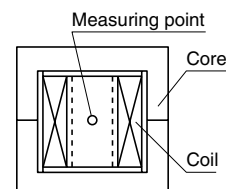

Ferrite

EER Series EER40 Cores

For Switching Power Supplies

Technical Data

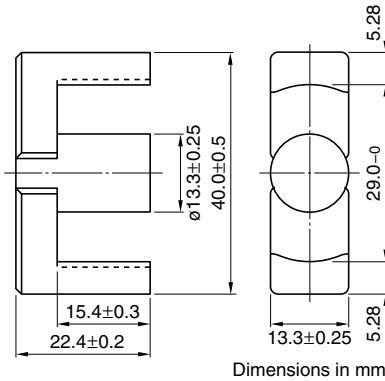

Parameter

Core factor	C1	mm ⁻¹	0.658
Effective magnetic path length	ℓ _e	mm	98.0
Effective cross-sectional area	A _e	mm ²	149
Effective core volume	V _e	mm ³	14600
Cross-sectional center pole area	A _{cp}	mm ²	139
Minimum cross-sectional center pole area	A _{cp min.}	mm ²	134
Cross-sectional winding area of core	A _{cw}	mm ²	249
Weight (approx.)		g	78

Part No.	AL-value (nH/N ²)	Core loss (W) at 100°C 100kHz, 200mT	Calculated output power (forward converter mode)
PC40EER40-Z	3620±25% (1kHz, 0.5mA)* 5160 min. (100kHz, 200mT)	6.3 max.	421W (100kHz)

* Coil: ø0.35 2UEW 100Ts

NI limit vs. AL-value for PC40EER40 gapped core (Typical)

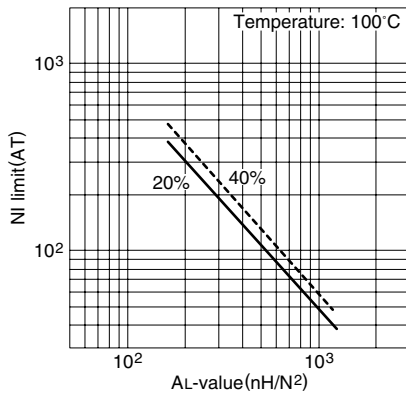

Note: NI limit shows the point where the exciting current is 20% and 40% away from its extended linear part.

AL-value vs. Air gap length for PC40EER40 core (Typical)

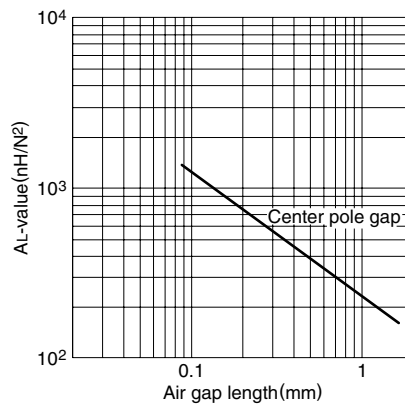

Measuring conditions • Coil: ø0.35 2UEW 100Ts
• Frequency: 1kHz
• Level: 0.5mA

Temperature rise vs. Total loss for EER40 core (Typical) (Ambient temperature: 25°C)

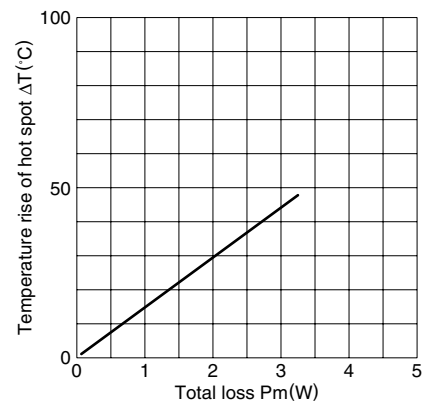

Note: The temperature rise is measured in the room whose temperature and humidity are fixed to 25°C and 45%RH, respectively. (approx. 400×300×300cm)

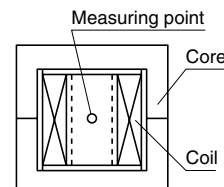

Ferrite

For Switching Power Supplies

Technical Data

EER Series EER42 Cores

JIS FEER 42

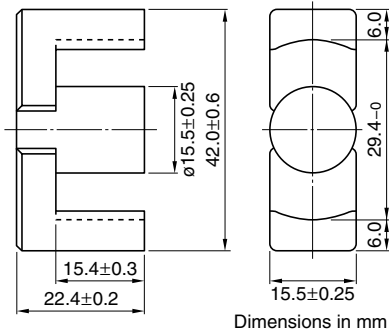

Parameter

Core factor	C1	mm ⁻¹	0.509
Effective magnetic path length	ℓ _e	mm	98.8
Effective cross-sectional area	A _e	mm ²	194
Effective core volume	V _e	mm ³	19200
Cross-sectional center pole area	A _{cp}	mm ²	187
Minimum cross-sectional center pole area	A _{cp min.}	mm ²	183
Cross-sectional winding area of core	A _{cw}	mm ²	223
Weight (approx.)		g	102

Part No.	AL-value (nH/N ²)	Core loss (W) at 100°C	Calculated output power
		100kHz, 200mT	(forward converter mode)
PC40EER42-Z	4690±25% (1kHz, 0.5mA)* 6670 min. (100kHz, 200mT)	8.6 max.	433W (100kHz)

* Coil: ø0.35 2UEW 100Ts

NI limit vs. AL-value for PC40EER42 gapped core (Typical)

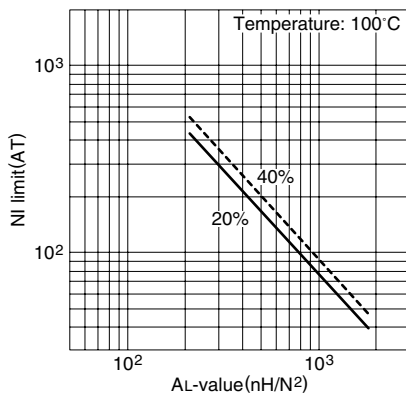

Note: NI limit shows the point where the exciting current is 20% and 40% away from its extended linear part.

AL-value vs. Air gap length for PC40EER42 core (Typical)

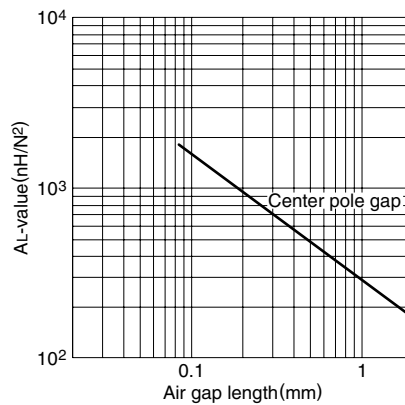

Measuring conditions • Coil: ø0.35 2UEW 100Ts
• Frequency: 1kHz
• Level: 0.5mA

Temperature rise vs. Total loss for EER42 core (Typical) (Ambient temperature: 25°C)

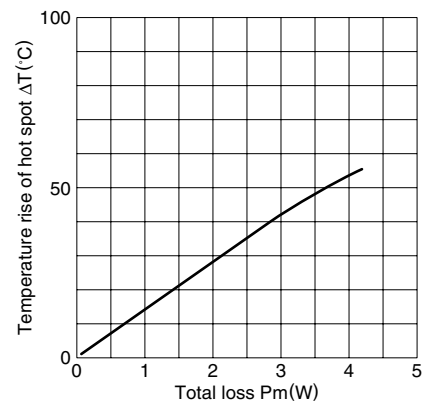

Note: The temperature rise is measured in the room whose temperature and humidity are fixed to 25°C and 45(%RH), respectively. (approx. 400×300×300cm)

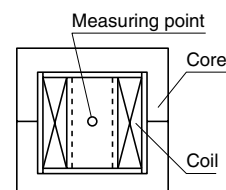

Ferrite

EER Series EER42/42/20 Cores

For Switching Power Supplies Technical Data

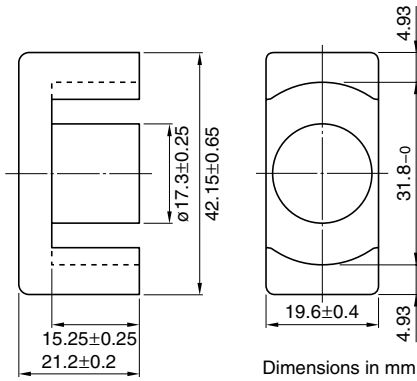

Parameter

Core factor	C1	mm ⁻¹	0.411
Effective magnetic path length	ℓ _e	mm	98.6
Effective cross-sectional area	A _e	mm ²	240
Effective core volume	V _e	mm ³	23700
Cross-sectional center pole area	A _{cp}	mm ²	235
Minimum cross-sectional center pole area	A _{cp min.}	mm ²	228
Cross-sectional winding area of core	A _{cw}	mm ²	229
Weight (approx.)		g	116

Part No.	AL-value (nH/N ²)	Core loss (W) at 100°C 100kHz, 200mT	Calculated output power (forward converter mode)
PC40EER42/42/20-Z	5340±25% (1kHz, 0.5mA)* 8260 min. (100kHz, 200mT)	10.7 max.	509W (100kHz)

* Coil: ø0.35 2UEW 100Ts

NI limit vs. AL-value for
PC40EER42/42/20 gapped core (Typical)

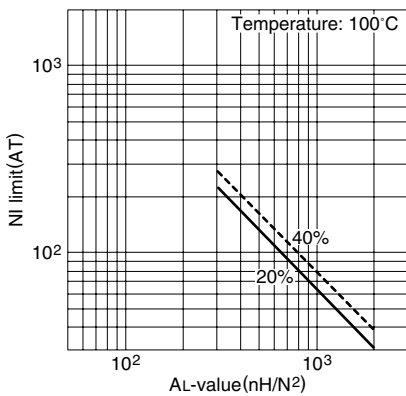

Note: NI limit shows the point where the exciting current is 20% and 40% away from its extended linear part.

AL-value vs. Air gap length for
PC40EER42/42/20 core (Typical)

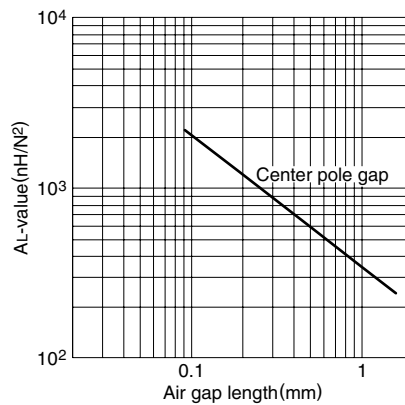

Measuring conditions • Coil: ø0.35 2UEW 100Ts
• Frequency: 1kHz
• Level: 0.5mA

Temperature rise vs. Total loss for
EER42/42/20core (Typical)
(Ambient temperature: 25°C)

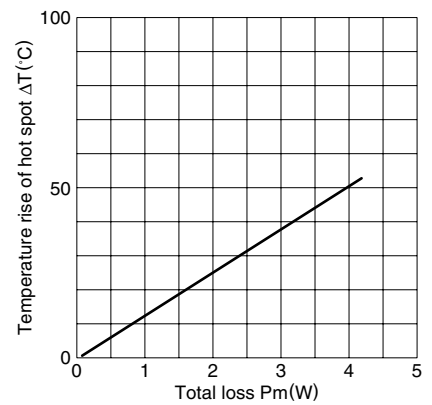

Note: The temperature rise is measured in the room whose temperature and humidity are fixed to 25°C and 45(%RH), respectively. (approx. 400×300×300cm)

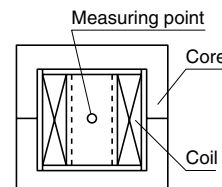

Ferrite

For Switching Power Supplies Technical Data

ETD Series ETD19 Cores

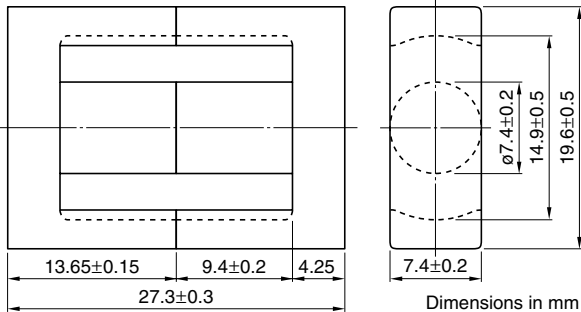

Parameter

Core factor	C1	mm ⁻¹	1.32
Effective magnetic path length	ℓ_e	mm	54.6
Effective cross-sectional area	A_e	mm ²	41.3
Effective core volume	V_e	mm ³	2260
Cross-sectional center pole area	A_{cp}	mm ²	43
Minimum cross-sectional center pole area	$A_{cp \text{ min.}}$	mm ²	40.7
Cross-sectional winding area of core	A_{cw}	mm ²	70.5
Weight (approx.)		g	13.3

Part No.	AL-value (nH/N ²)	Core loss (W) at 100°C 100kHz, 200mT	Calculated output power (forward converter mode)
PC40ETD19-Z	1720±25% (1kHz, 0.5mA)* 2380 min. (100kHz, 200mT)	1.1 max.	79W (100kHz)

* Coil: $\phi 0.35$ 2UEW 100Ts

NI limit vs. AL-value for PC40ETD19 gapped core (Typical)

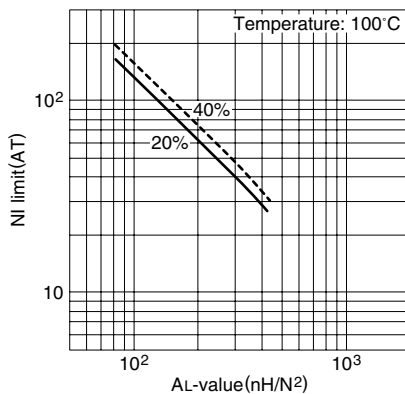

Note: NI limit shows the point where the exciting current is 20% and 40% away from its extended linear part.

AL-value vs. Air gap length for PC40ETD19 core (Typical)

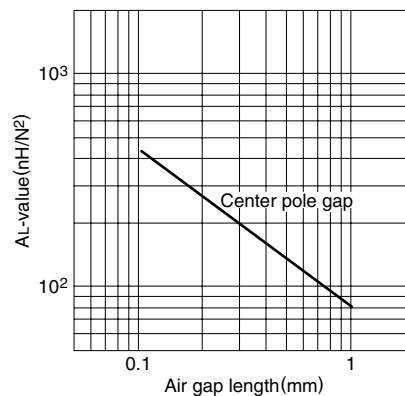

Measuring conditions • Coil: $\phi 0.35$ 2UEW 100Ts
• Frequency: 1kHz
• Level: 0.5mA

Temperature rise vs. Total loss for ETD19 core (Typical) (Ambient temperature: 25°C)

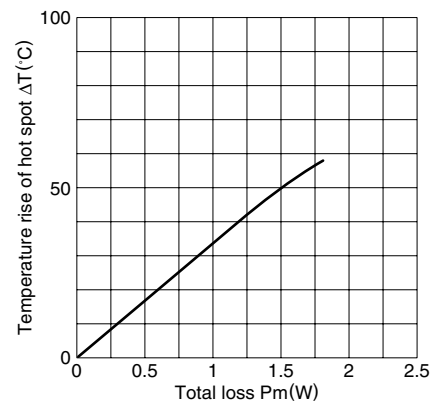

Note: The temperature rise is measured in the room whose temperature and humidity are fixed to 25°C and 45%RH, respectively. (approx. 400×300×300cm)

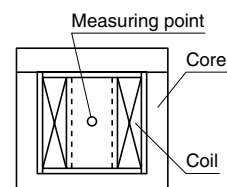

Ferrite

For Switching Power Supplies Technical Data

ETD Series ETD24 Cores

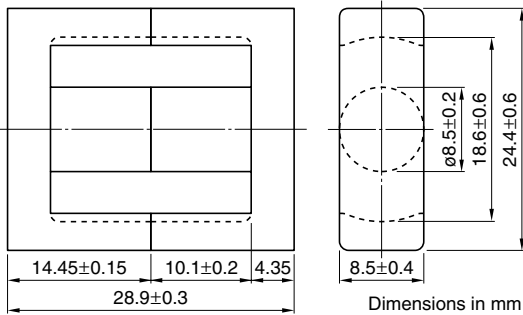

Parameter

Core factor	C1	mm ⁻¹	1.10
Effective magnetic path length	ℓ_e	mm	61.9
Effective cross-sectional area	A_e	mm ²	56.3
Effective core volume	V_e	mm ³	3480
Cross-sectional center pole area	A_{cp}	mm ²	56.7
Minimum cross-sectional center pole area	$A_{cp \text{ min.}}$	mm ²	54.1
Cross-sectional winding area of core	A_{cw}	mm ²	102
Weight (approx.)		g	19.5

Part No.	AL-value (nH/N ²)	Core loss (W) at 100°C	Calculated output power
		100kHz, 200mT	(forward converter mode)
PC40ETD24-Z	2125±25% (1kHz, 0.5mA)* 2860 min. (100kHz, 200mT)	1.6 max.	115W (100kHz)

* Coil: $\phi 0.35$ 2UEW 100Ts

NI limit vs. AL-value for PC40ETD24 gapped core (Typical)

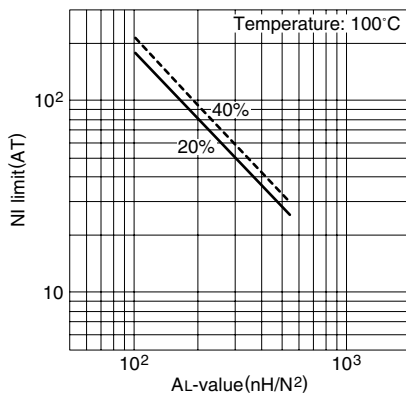

Note: NI limit shows the point where the exciting current is 20% and 40% away from its extended linear part.

AL-value vs. Air gap length for PC40ETD24 core (Typical)

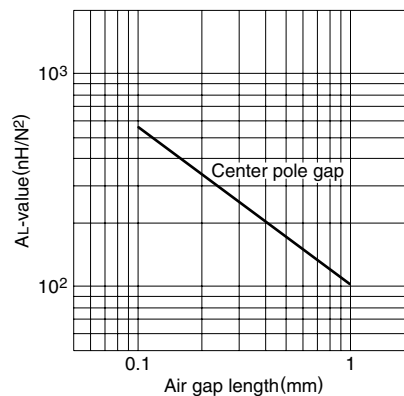

Measuring conditions • Coil: $\phi 0.35$ 2UEW 100Ts
• Frequency: 1kHz
• Level: 0.5mA

Temperature rise vs. Total loss for ETD24 core (Typical) (Ambient temperature: 25°C)

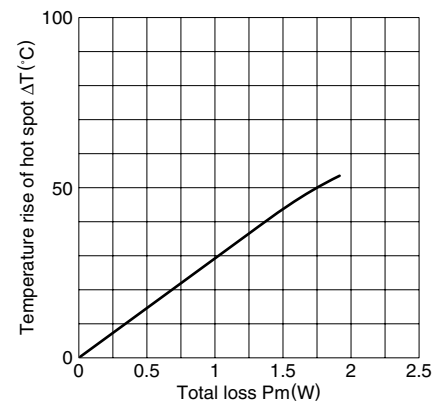

Note: The temperature rise is measured in the room whose temperature and humidity are fixed to 25°C and 45%(%)RH, respectively. (approx. 400×300×300cm)

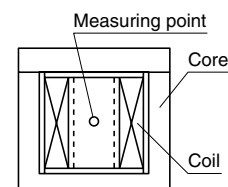

Ferrite

For Switching Power Supplies

Technical Data

ETD Series ETD29 Cores

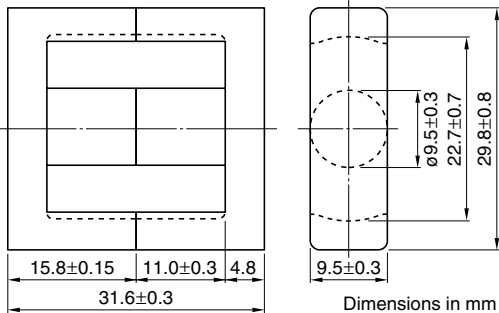

Parameter

Core factor	C1	mm ⁻¹	0.959
Effective magnetic path length	ℓ_e	mm	70.6
Effective cross-sectional area	A_e	mm ²	73.6
Effective core volume	V_e	mm ³	5170
Cross-sectional center pole area	A_{cp}	mm ²	70.9
Minimum cross-sectional center pole area	$A_{cp \text{ min.}}$	mm ²	66.5
Cross-sectional winding area of core	A_{cw}	mm ²	145.2
Weight (approx.)		g	28

Part No.	AL-value (nH/N ²)	Core loss (W) at 100°C 100kHz, 200mT	Calculated output power (forward converter mode)
PC40ETD29-Z	2500±25% (1kHz, 0.5mA)* 3540 min. (100kHz, 200mT)	2.4 max.	170W (100kHz)

* Coil: $\phi 0.35$ 2UEW 100Ts

NI limit vs. AL-value for PC40ETD29 gapped core (Typical)

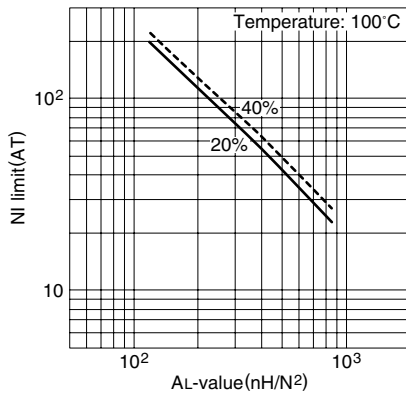

Note: NI limit shows the point where the exciting current is 20% and 40% away from its extended linear part.

AL-value vs. Air gap length for PC40ETD29 core (Typical)

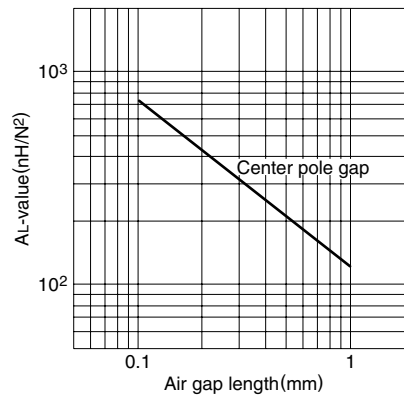

Measuring conditions • Coil: $\phi 0.35$ 2UEW 100Ts
• Frequency: 1kHz
• Level: 0.5mA

Temperature rise vs. Total loss for ETD29 core (Typical) (Ambient temperature: 25°C)

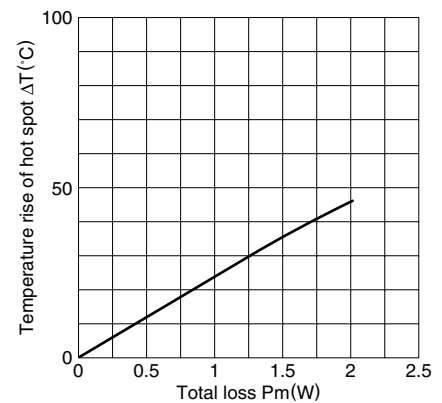

Note: The temperature rise is measured in the room whose temperature and humidity are fixed to 25°C and 45%RH, respectively. (approx. 400×300×300cm)

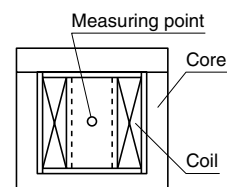

Ferrite

For Switching Power Supplies

Technical Data

ETD Series ETD34 Cores

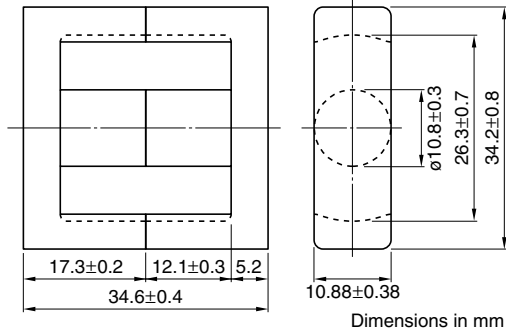

Parameter

Core factor	C1	mm ⁻¹	0.810
Effective magnetic path length	ℓ_e	mm	78.6
Effective cross-sectional area	A_e	mm ²	97.1
Effective core volume	V_e	mm ³	7630
Cross-sectional center pole area	A_{cp}	mm ²	91.6
Minimum cross-sectional center pole area	$A_{cp \text{ min.}}$	mm ²	86.6
Cross-sectional winding area of core	A_{cw}	mm ²	188
Weight (approx.)		g	40

Part No.	AL-value (nH/N ²)	Core loss (W) at 100°C	Calculated output power
		100kHz, 200mT	(forward converter mode)
PC40ETD34-Z	2780±25% (1kHz, 0.5mA)* 4190 min. (100kHz, 200mT)	3.31 max.	271W (100kHz)

* Coil: $\phi 0.35$ 2UEW 100Ts

NI limit vs. AL-value for PC40ETD34 gapped core (Typical)

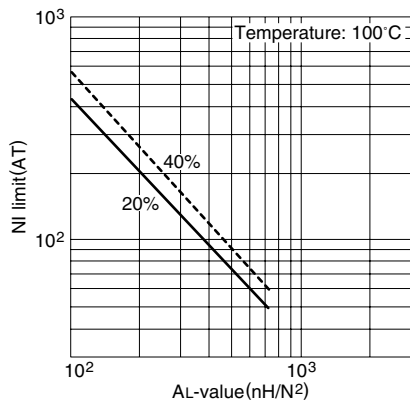

Note: NI limit shows the point where the exciting current is 20% and 40% away from its extended linear part.

AL-value vs. Air gap length for PC40ETD34 core (Typical)

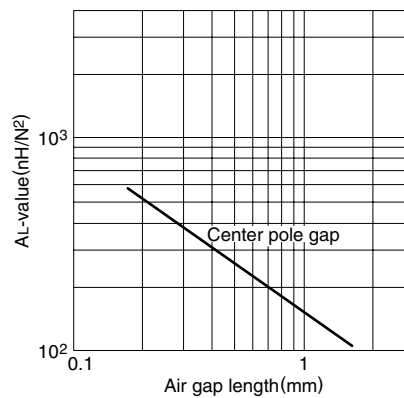

Measuring conditions • Coil: $\phi 0.35$ 2UEW 100Ts
• Frequency: 1kHz
• Level: 0.5mA

Temperature rise vs. Total loss for ETD34 core (Typical) (Ambient temperature: 25°C)

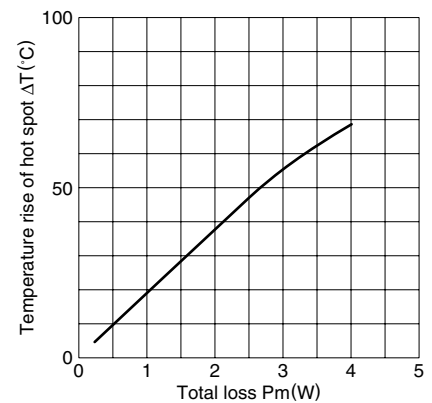

Note: The temperature rise is measured in the room whose temperature and humidity are fixed to 25°C and 45(%RH), respectively. (approx. 400×300×300cm)

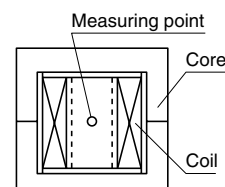

Ferrite

For Switching Power Supplies

Technical Data

ETD Series ETD39 Cores

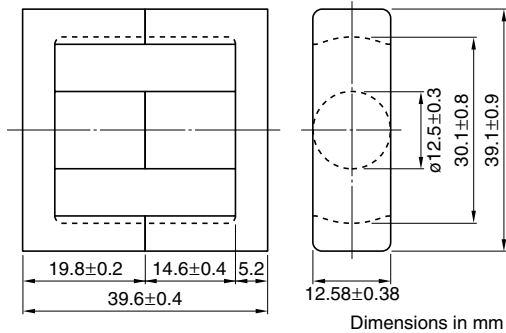

Parameter

Core factor	C1	mm ⁻¹	0.737
Effective magnetic path length	ℓ_e	mm	92.1
Effective cross-sectional area	A_e	mm ²	125
Effective core volume	V_e	mm ³	11500
Cross-sectional center pole area	A_{cp}	mm ²	123
Minimum cross-sectional center pole area	$A_{cp \text{ min.}}$	mm ²	117
Cross-sectional winding area of core	A_{cw}	mm ²	257
Weight (approx.)		g	60

Part No.	AL-value (nH/N ²)	Core loss (W) at 100°C 100kHz, 200mT	Calculated output power (forward converter mode)
PC40ETD39-Z	3150±25% (1kHz, 0.5mA)* 4600 min. (100kHz, 200mT)	5.3 max.	382W (100kHz)

* Coil: $\phi 0.35$ 2UEW 100Ts

NI limit vs. AL-value for PC40ETD39 gapped core (Typical)

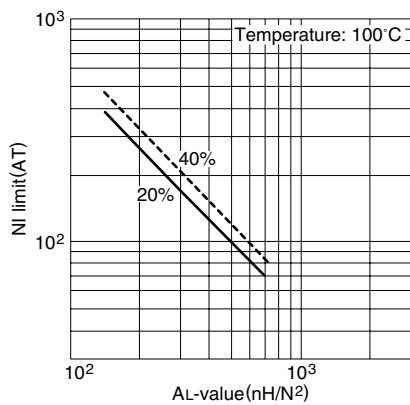

Note: NI limit shows the point where the exciting current is 20% and 40% away from its extended linear part.

AL-value vs. Air gap length for PC40ETD39 core (Typical)

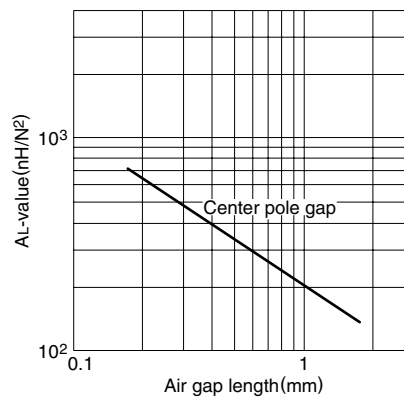

Measuring conditions • Coil: $\phi 0.35$ 2UEW 100Ts
• Frequency: 1kHz
• Level: 0.5mA

Temperature rise vs. Total loss for ETD39 core (Typical) (Ambient temperature: 25°C)

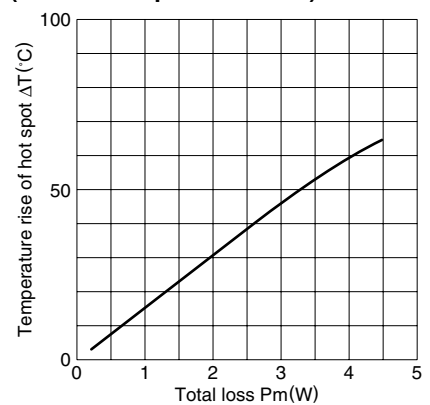

Note: The temperature rise is measured in the room whose temperature and humidity are fixed to 25°C and 45%RH, respectively. (approx. 400×300×300cm)

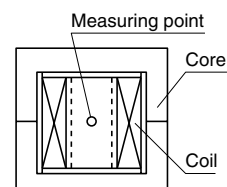

Ferrite

For Switching Power Supplies

Technical Data

ETD Series ETD44 Cores

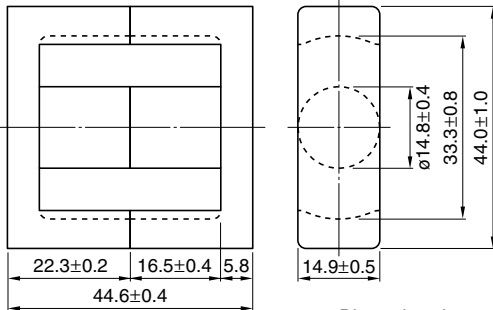

Dimensions in mm

Parameter

Core factor	C1	mm ⁻¹	0.589
Effective magnetic path length	ℓ _e	mm	103
Effective cross-sectional area	A _e	mm ²	175
Effective core volume	V _e	mm ³	18000
Cross-sectional center pole area	A _{cp}	mm ²	172
Minimum cross-sectional center pole area	A _{cp min.}	mm ²	163
Cross-sectional winding area of core	A _{cw}	mm ²	305
Weight (approx.)		g	94

Part No.	AL-value (nH/N ²)	Core loss (W) at 100°C 100kHz, 200mT	Calculated output power (forward converter mode)
PC40ETD44-Z	4000±25% (1kHz, 0.5mA)* 5760 min. (100kHz, 200mT)	8.3 max.	523W (100kHz)

* Coil: ø0.35 2UEW 100Ts

NI limit vs. AL-value for PC40ETD44 gapped core (Typical)

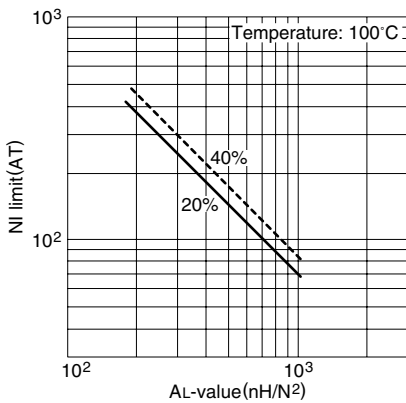

Note: NI limit shows the point where the exciting current is 20% and 40% away from its extended linear part.

AL-value vs. Air gap length for PC40ETD44 core (Typical)

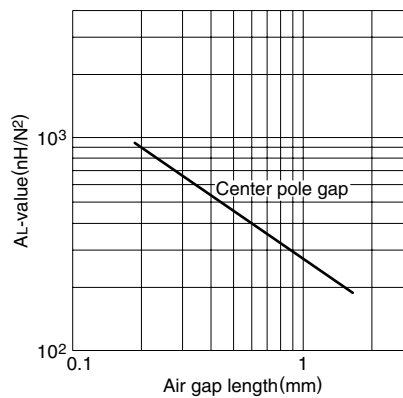

Measuring conditions • Coil: ø0.35 2UEW 100Ts
• Frequency: 1kHz
• Level: 0.5mA

Temperature rise vs. Total loss for ETD44 core (Typical) (Ambient temperature: 25°C)

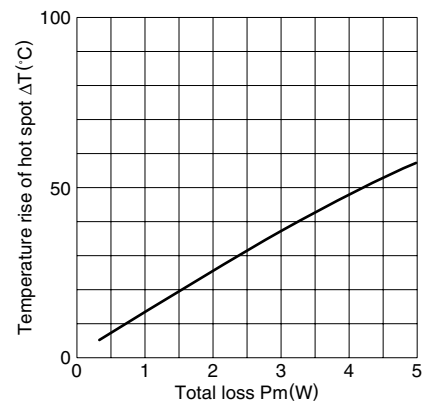

Note: The temperature rise is measured in the room whose temperature and humidity are fixed to 25°C and 45(%RH), respectively. (approx. 400×300×300cm)

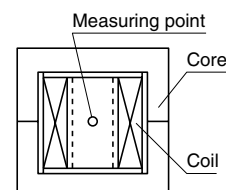

Ferrite

For Switching Power Supplies

Technical Data

ETD Series ETD49 Cores

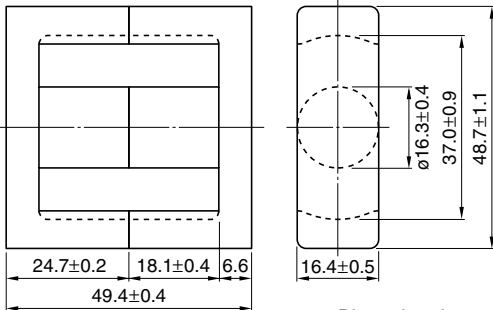

Dimensions in mm

Parameter

Core factor	C1	mm ⁻¹	0.535
Effective magnetic path length	ℓ _e	mm	114
Effective cross-sectional area	A _e	mm ²	213
Effective core volume	V _e	mm ³	24300
Cross-sectional center pole area	A _{cp}	mm ²	209
Minimum cross-sectional center pole area	A _{cp min.}	mm ²	199
Cross-sectional winding area of core	A _{cw}	mm ²	375
Weight (approx.)		g	124

Part No.	AL-value (nH/N ²)	Core loss (W) at 100°C 100kHz, 200mT	Calculated output power (forward converter mode)
PC40ETD49-Z	4440±25% (1kHz, 0.5mA)* 6340 min. (100kHz, 200mT)	11.2 max.	682W (100kHz)

* Coil: ø0.35 2UEW 100Ts

NI limit vs. AL-value for PC40ETD49 gapped core (Typical)

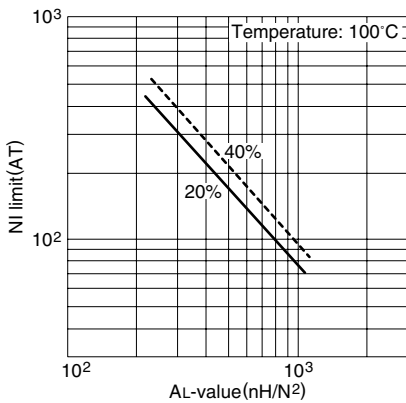

Note: NI limit shows the point where the exciting current is 20% and 40% away from its extended linear part.

AL-value vs. Air gap length for PC40ETD49 core (Typical)

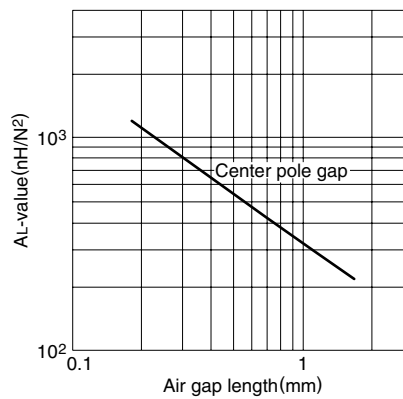

Measuring conditions • Coil: ø0.35 2UEW 100Ts
• Frequency: 1kHz
• Level: 0.5mA

Temperature rise vs. Total loss for ETD49 core (Typical) (Ambient temperature: 25°C)

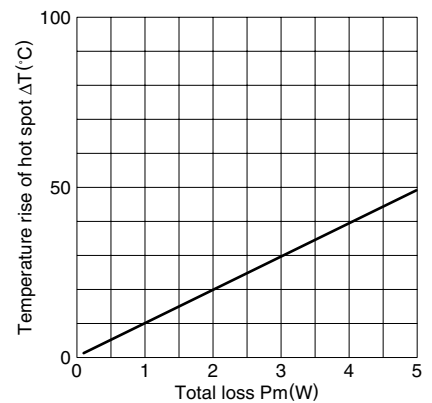

Note: The temperature rise is measured in the room whose temperature and humidity are fixed to 25°C and 45%RH, respectively. (approx. 400×300×300cm)

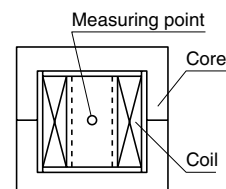

Ferrite

For Switching Power Supplies

Technical Data

PQ Series PQ20/16 Cores

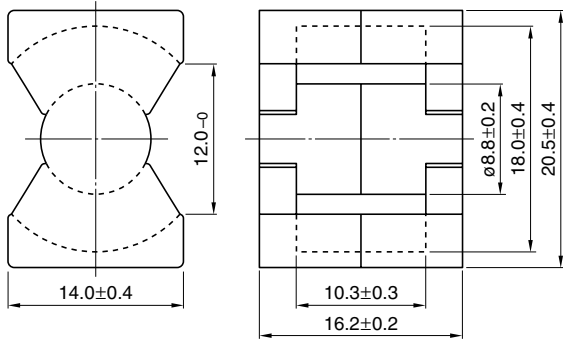

Dimensions in mm

Parameter

Core factor	C1	mm ⁻¹	0.603
Effective magnetic path length	ℓ _e	mm	37.4
Effective cross-sectional area	A _e	mm ²	62
Effective core volume	V _e	mm ³	2310
Cross-sectional center pole area	A _{cp}	mm ²	60.8
Minimum cross-sectional center pole area	A _{cp min.}	mm ²	58.1
Cross-sectional winding area of core	A _{cw}	mm ²	47.4
Weight (approx.)		g	13

Part No.	AL-value (nH/N ²)	Core loss (W) at 100°C 100kHz, 200mT	Calculated output power (forward converter mode)
PC44PQ20/16Z-12	3880±25% (1kHz, 0.5mA)* 5210 min. (100kHz, 200mT)	0.84 max.	70W (100kHz)

* Coil: ø0.35 2UEW 100Ts

NI limit vs. AL-value for PC44PQ20/16 gapped core (Typical)

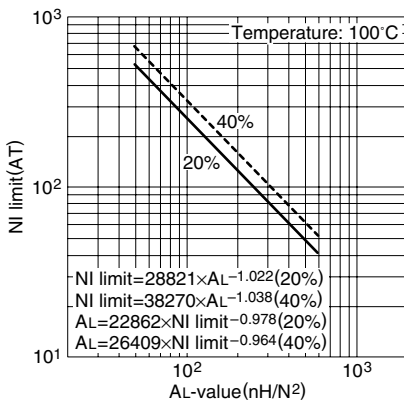

Note: NI limit shows the point where the exciting current is 20% and 40% away from its extended linear part.

AL-value vs. Air gap length for PC44PQ20/16 core (Typical)

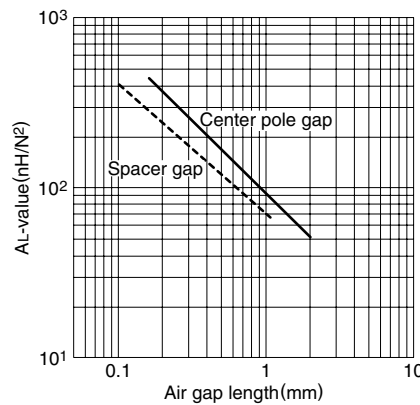

Measuring conditions • Coil: ø0.35 2UEW 100Ts
• Frequency: 1kHz
• Level: 0.5mA

Temperature rise vs. Total loss for PQ20/16 core (Typical) (Ambient temperature: 25°C)

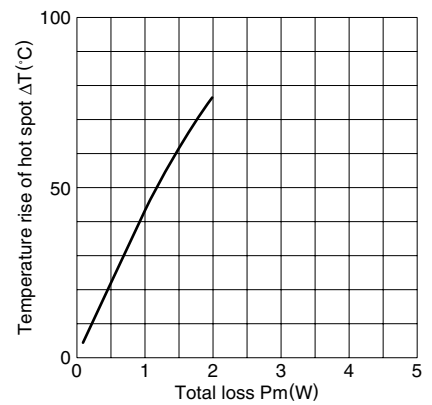

Note: The temperature rise is measured in the room whose temperature and humidity are fixed to 25°C and 45%RH, respectively. (approx. 400×300×300cm)

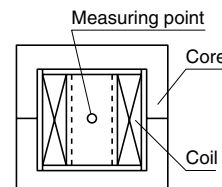

Ferrite

For Switching Power Supplies

Technical Data

PQ Series PQ20/20 Cores

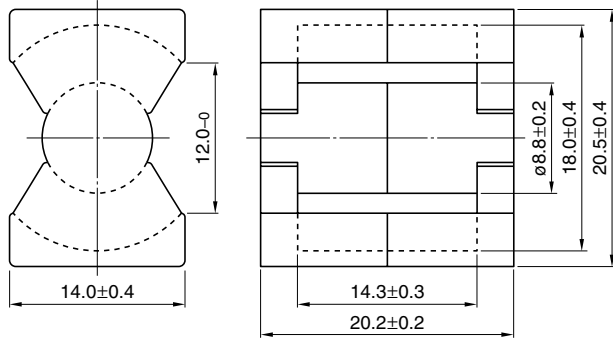

Dimensions in mm

Parameter

Core factor	C1	mm ⁻¹	0.732
Effective magnetic path length	ℓ _e	mm	45.4
Effective cross-sectional area	A _e	mm ²	62
Effective core volume	V _e	mm ³	2790
Cross-sectional center pole area	A _{cp}	mm ²	60.8
Minimum cross-sectional center pole area	A _{cp min.}	mm ²	58.1
Cross-sectional winding area of core	A _{cw}	mm ²	65.8
Weight (approx.)		g	15

Part No.	AL-value (nH/N ²)	Core loss (W) at 100°C		Calculated output power (forward converter mode)
		100kHz, 200mT	500kHz, 50mT	
PC44PQ20/20Z-12	3150±25% (1kHz, 0.5mA)* 4290 min. (100kHz, 200mT)	1.02 max.		92W (100kHz)
PC50PQ20/20Z-12	2000±25% (1kHz, 0.5mA)*	0.33 max.		187W (500kHz)

* Coil: ø0.35 2UEW 100Ts

NI limit vs. AL-value for PC44PQ20/20 gapped core (Typical)

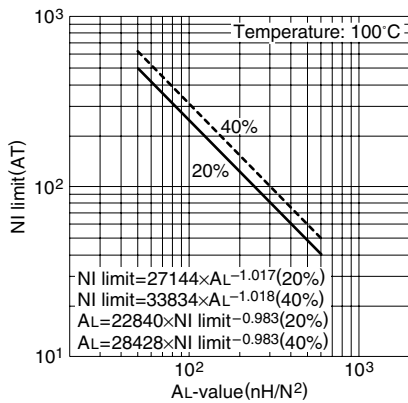

AL-value vs. Air gap length for PC44PQ20/20 core (Typical)

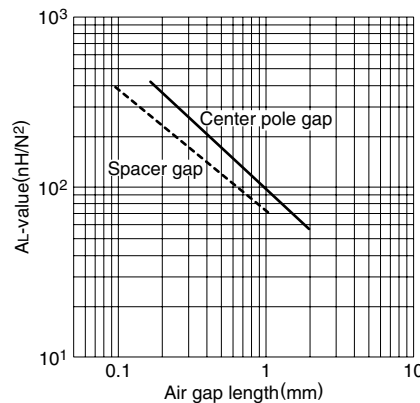

Temperature rise vs. Total loss for PQ20/20 core (Typical) (Ambient temperature: 25°C)

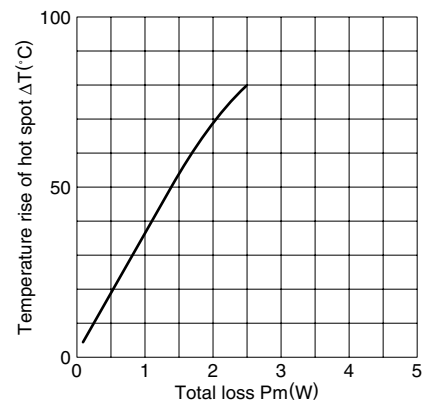

Note: The temperature rise is measured in the room whose temperature and humidity are fixed to 25°C and 45%RH, respectively. (approx. 400×300×300cm)

NI limit vs. AL-value for PC50PQ20/20 gapped core (Typical)

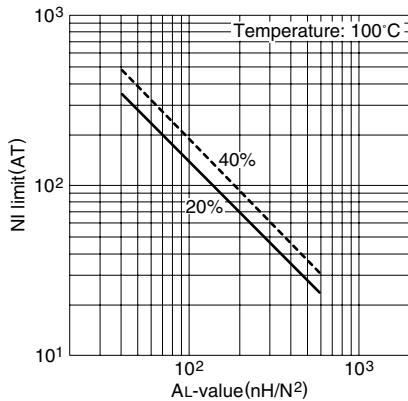

Note: NI limit shows the point where the exciting current is 20% and 40% away from its extended linear part.

AL-value vs. Air gap length for PC50PQ20/20 core (Typical)

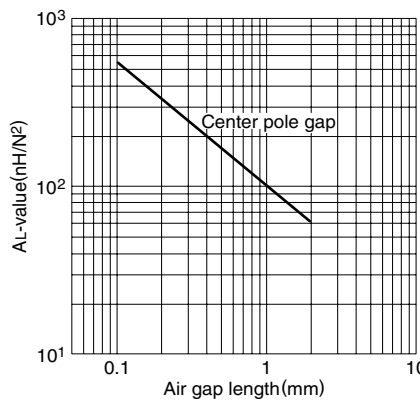

Measuring conditions • Coil: ø0.35 2UEW 100Ts
• Frequency: 1kHz
• Level: 0.5mA

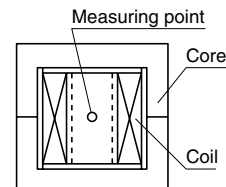

Ferrite

For Switching Power Supplies

Technical Data

PQ Series PQ26/20 Cores

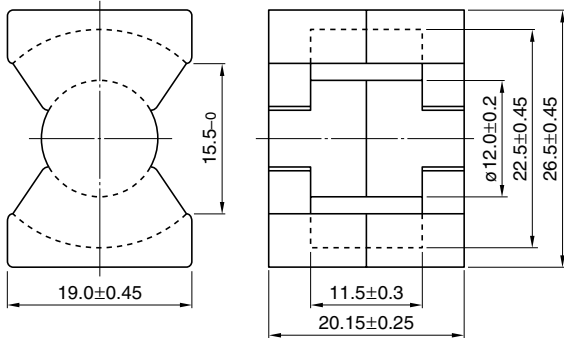

Dimensions in mm

Parameter

Core factor	C1	mm ⁻¹	0.389
Effective magnetic path length	ℓ_e	mm	46.3
Effective cross-sectional area	A_e	mm ²	119
Effective core volume	V_e	mm ³	5490
Cross-sectional center pole area	A_{cp}	mm ²	113
Minimum cross-sectional center pole area	$A_{cp \text{ min.}}$	mm ²	109
Cross-sectional winding area of core	A_{cw}	mm ²	60.4
Weight (approx.)		g	31

Part No.	AL-value (nH/N ²)	Core loss (W) at 100°C 100kHz, 200mT	Calculated output power (forward converter mode)
PC44PQ26/20Z-12	6170±25% (1kHz, 0.5mA)* 8060 min. (100kHz, 200mT)	1.94 max.	170W (100kHz)

* Coil: $\phi 0.35$ 2UEW 100Ts

NI limit vs. AL-value for PC44PQ26/20 gapped core (Typical)

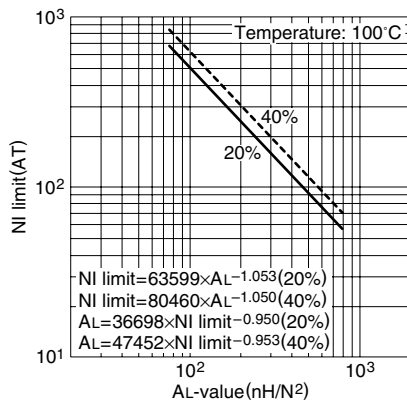

Note: NI limit shows the point where the exciting current is 20% and 40% away from its extended linear part.

AL-value vs. Air gap length for PC44PQ26/20 core (Typical)

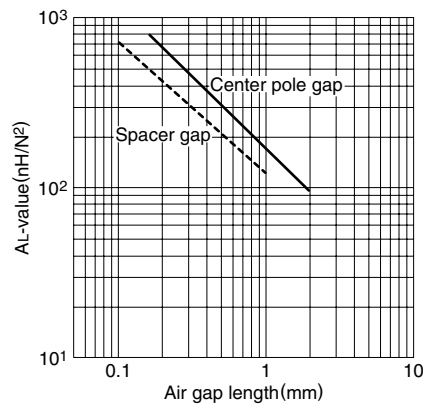

Measuring conditions • Coil: $\phi 0.35$ 2UEW 100Ts
• Frequency: 1kHz
• Level: 0.5mA

Temperature rise vs. Total loss for PQ26/20 core (Typical) (Ambient temperature: 25°C)

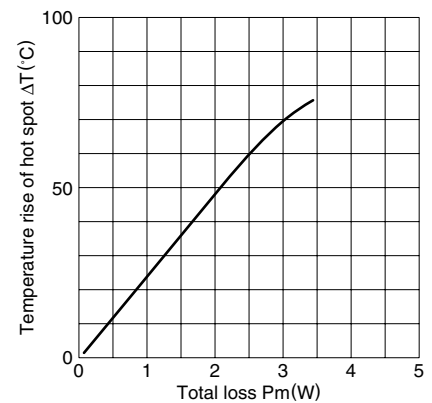

Note: The temperature rise is measured in the room whose temperature and humidity are fixed to 25°C and 45%RH, respectively. (approx. 400×300×300cm)

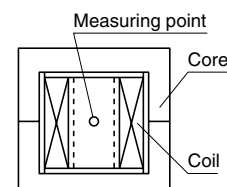

Ferrite

For Switching Power Supplies

Technical Data

PQ Series PQ26/25 Cores

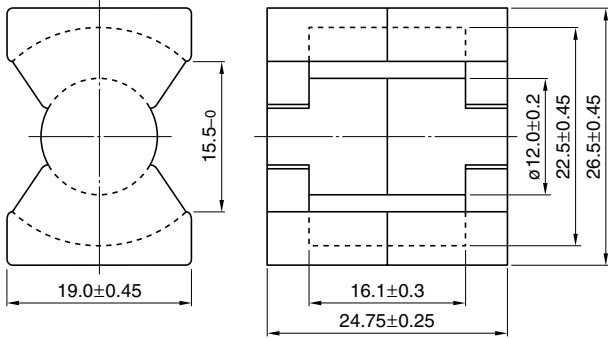

Dimensions in mm

Parameter

Core factor	C1	mm ⁻¹	0.470
Effective magnetic path length	ℓ _e	mm	55.5
Effective cross-sectional area	A _e	mm ²	118
Effective core volume	V _e	mm ³	6530
Cross-sectional center pole area	A _{cp}	mm ²	113
Minimum cross-sectional center pole area	A _{cp min.}	mm ²	109
Cross-sectional winding area of core	A _{cw}	mm ²	84.5
Weight (approx.)		g	36

Part No.	AL-value (nH/N ²)	Core loss (W) at 100°C		Calculated output power (forward converter mode)
		100kHz, 200mT	500kHz, 50mT	
PC44PQ26/25Z-12	5250±25% (1kHz, 0.5mA)* 6680 min. (100kHz, 200mT)	2.32 max.		195W (100kHz)
PC50PQ26/25Z-12	3200±25% (1kHz, 0.5mA)*	0.76 max.		366W (500kHz)

* Coil: ø0.35 2UEW 100Ts

NI limit vs. AL-value for PC44PQ26/25 gapped core (Typical)

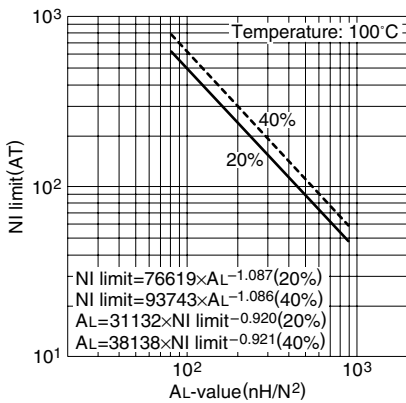

AL-value vs. Air gap length for PC44PQ26/25 core (Typical)

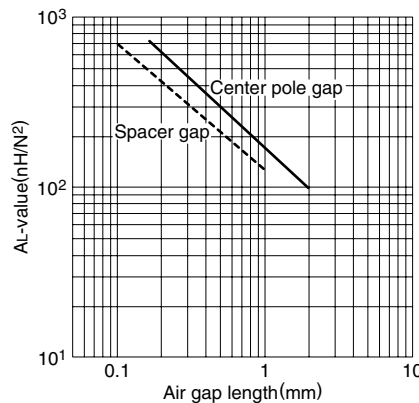

Temperature rise vs. Total loss for PQ26/25 core (Typical) (Ambient temperature: 25°C)

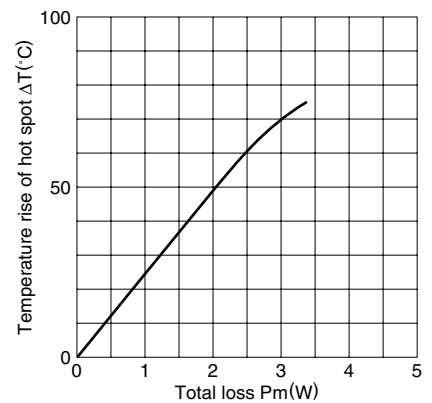

Note: The temperature rise is measured in the room whose temperature and humidity are fixed to 25°C and 45%RH, respectively. (approx. 400×300×300cm)

NI limit vs. AL-value for PC50PQ26/25 gapped core (Typical)

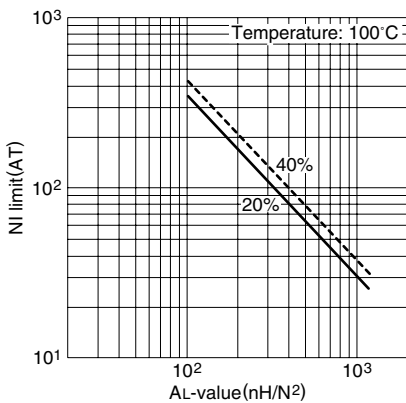

Note: NI limit shows the point where the exciting current is 20% and 40% away from its extended linear part.

AL-value vs. Air gap length for PC50PQ26/25 core (Typical)

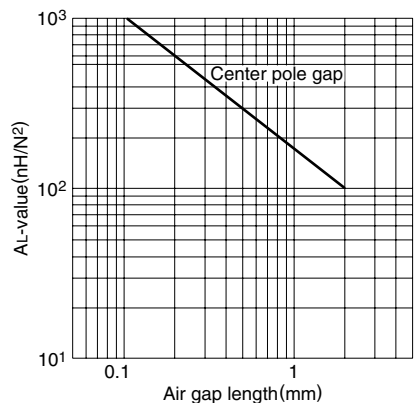

Measuring conditions • Coil: ø0.35 2UEW 100Ts
• Frequency: 1kHz
• Level: 0.5mA

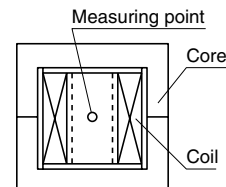

Ferrite

For Switching Power Supplies

Technical Data

PQ Series PQ32/20 Cores

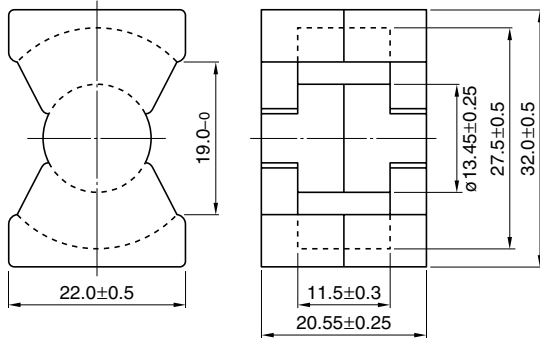

Dimensions in mm

Parameter

Core factor	C1	mm ⁻¹	0.326
Effective magnetic path length	ℓ_e	mm	55.5
Effective cross-sectional area	A_e	mm ²	170
Effective core volume	V_e	mm ³	9420
Cross-sectional center pole area	A_{cp}	mm ²	142
Minimum cross-sectional center pole area	$A_{cp \text{ min.}}$	mm ²	137
Cross-sectional winding area of core	A_{cw}	mm ²	80.8
Weight (approx.)		g	42

Part No.	AL-value (nH/N ²)	Core loss (W) at 100°C 100kHz, 200mT	Calculated output power (forward converter mode)
PC44PQ32/20Z-12	7310±25% (1kHz, 0.5mA)* 9640 min. (100kHz, 200mT)	2.92 max.	232W (100kHz)

* Coil: $\phi 0.35$ 2UEW 100Ts

NI limit vs. AL-value for PC44PQ32/20 gapped core (Typical)

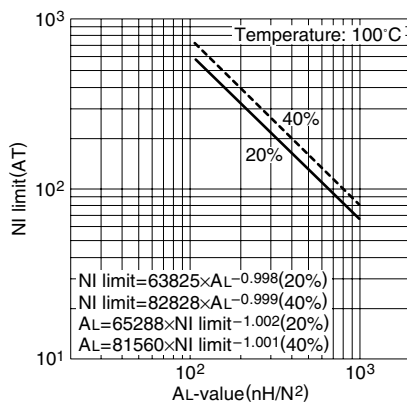

Note: NI limit shows the point where the exciting current is 20% and 40% away from its extended linear part.

AL-value vs. Air gap length for PC44PQ32/20 core (Typical)

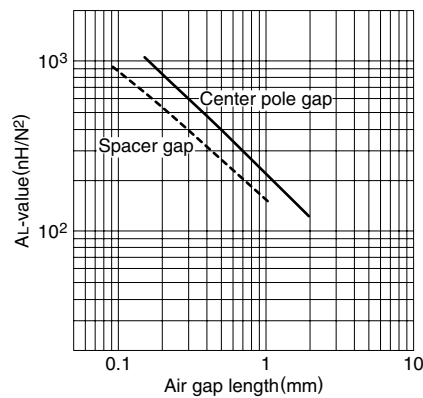

Measuring conditions • Coil: $\phi 0.35$ 2UEW 100Ts
• Frequency: 1kHz
• Level: 0.5mA

Temperature rise vs. Total loss for PQ32/20 core (Typical) (Ambient temperature: 25°C)

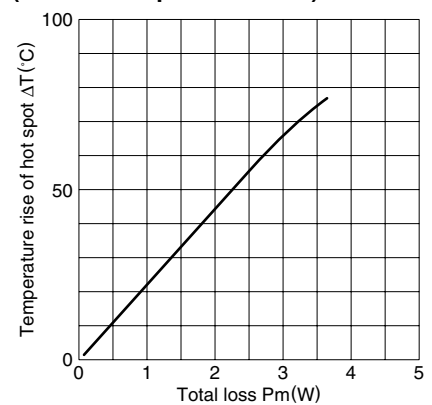

Note: The temperature rise is measured in the room whose temperature and humidity are fixed to 25°C and 45%RH, respectively. (approx. 400×300×300cm)

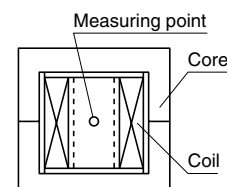

Ferrite

For Switching Power Supplies

Technical Data

PQ Series PQ32/30 Cores

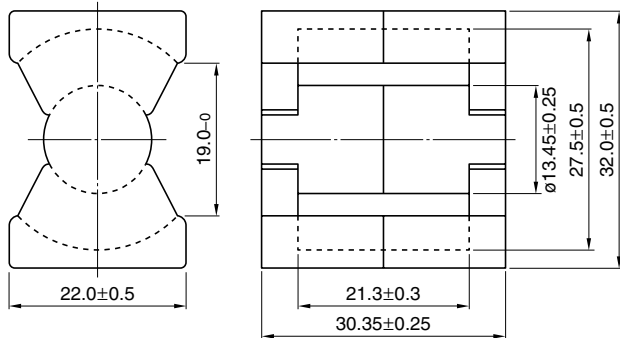

Dimensions in mm

Parameter

Core factor	C1	mm ⁻¹	0.463
Effective magnetic path length	ℓ_e	mm	74.6
Effective cross-sectional area	A_e	mm ²	161
Effective core volume	V_e	mm ³	11970
Cross-sectional center pole area	A_{cp}	mm ²	142
Minimum cross-sectional center pole area	$A_{cp \text{ min.}}$	mm ²	137
Cross-sectional winding area of core	A_{cw}	mm ²	149.6
Weight (approx.)		g	55

Part No.	AL-value (nH/N ²)	Core loss (W) at 100°C 100kHz, 200mT	Calculated output power (forward converter mode)
PC44PQ32/30Z-12	5140±25% (1kHz, 0.5mA)* 6790 min. (100kHz, 200mT)	3.92 max.	331W (100kHz)

* Coil: $\phi 0.4$ 2UEW 100Ts

NI limit vs. AL-value for PC44PQ32/30 gapped core (Typical)

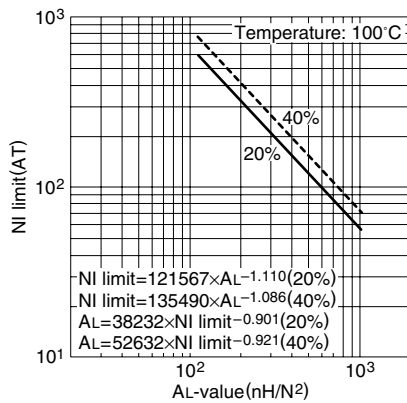

Note: NI limit shows the point where the exciting current is 20% and 40% away from its extended linear part.

AL-value vs. Air gap length for PC44PQ32/30 core (Typical)

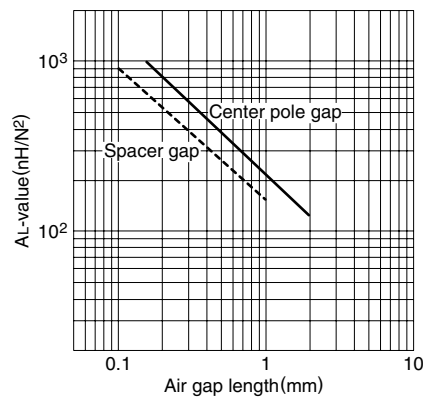

Measuring conditions • Coil: $\phi 0.4$ 2UEW 100Ts
 • Frequency: 1kHz
 • Level: 0.5mA

Temperature rise vs. Total loss for PQ32/30 core (Typical) (Ambient temperature: 25°C)

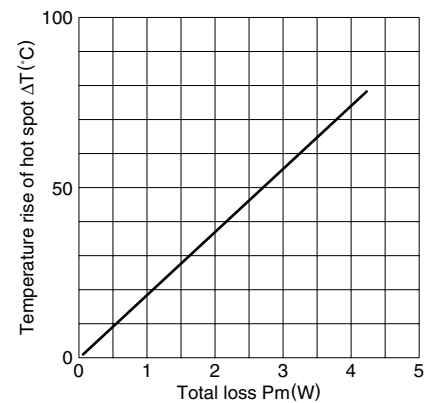

Note: The temperature rise is measured in the room whose temperature and humidity are fixed to 25°C and 45%RH, respectively. (approx. 400×300×300cm)

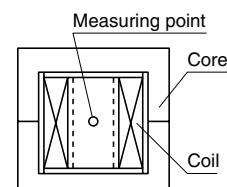

Ferrite

For Switching Power Supplies Technical Data

PQ Series PQ35/35 Cores

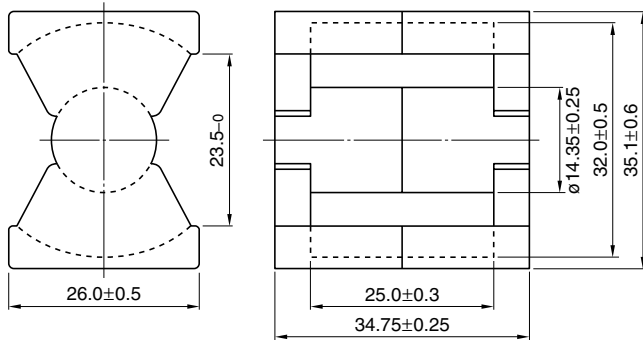

Dimensions in mm

Parameter

Core factor	C1	mm ⁻¹	0.448
Effective magnetic path length	ℓ_e	mm	87.9
Effective cross-sectional area	A_e	mm ²	196
Effective core volume	V_e	mm ³	17200
Cross-sectional center pole area	A_{cp}	mm ²	162
Minimum cross-sectional center pole area	$A_{cp \text{ min.}}$	mm ²	156
Cross-sectional winding area of core	A_{cw}	mm ²	220.6
Weight (approx.)		g	73

Part No.	AL-value (nH/N ²)	Core loss (W) at 100°C 100kHz, 200mT	Calculated output power (forward converter mode)
PC44PQ35/35Z-12	4860±25% (1kHz, 0.5mA)* 7010 min. (100kHz, 200mT)	5.27 max.	452W (100kHz)

* Coil: ø0.4 2UEW 100Ts

NI limit vs. AL-value for PC44PQ35/35 gapped core (Typical)

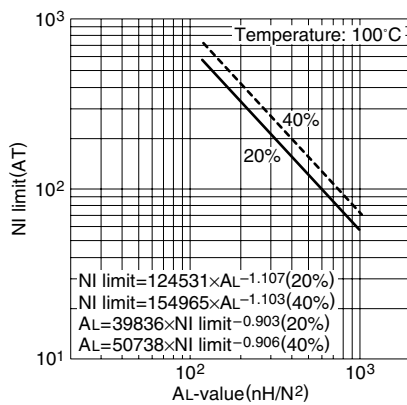

Note: NI limit shows the point where the exciting current is 20% and 40% away from its extended linear part.

AL-value vs. Air gap length for PC44PQ35/35 core (Typical)

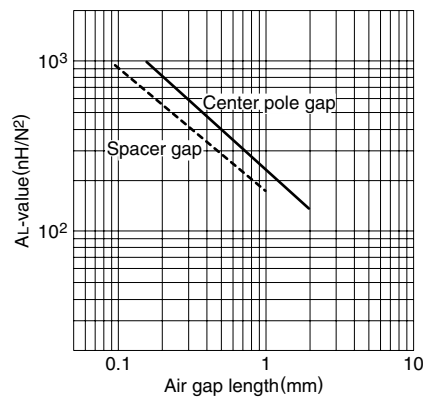

Measuring conditions • Coil: ø0.4 2UEW 100Ts
• Frequency: 1kHz
• Level: 0.5mA

Temperature rise vs. Total loss for PQ35/35 core (Typical) (Ambient temperature: 25°C)

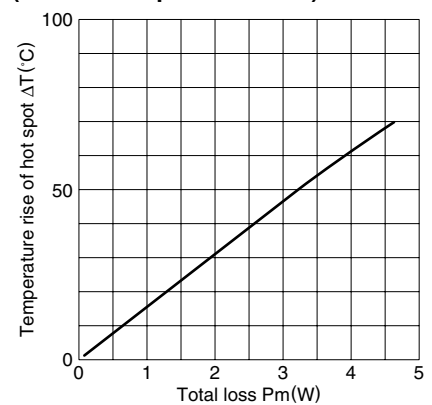

Note: The temperature rise is measured in the room whose temperature and humidity are fixed to 25°C and 45%RH, respectively. (approx. 400×300×300cm)

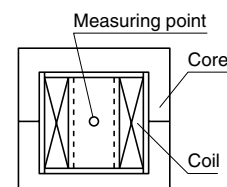

Ferrite

For Switching Power Supplies

Technical Data

PQ Series PQ40/40 Cores

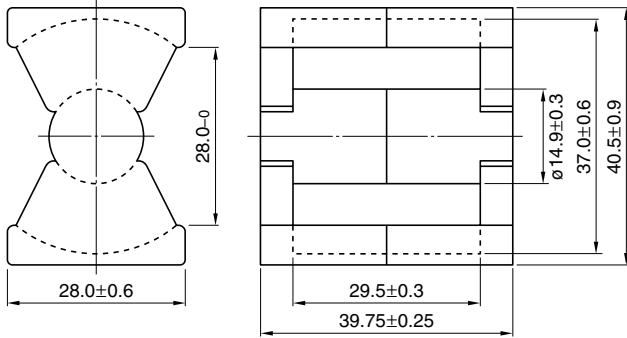

Dimensions in mm

Parameter

Core factor	C1	mm ⁻¹	0.507
Effective magnetic path length	ℓ _e	mm	102
Effective cross-sectional area	A _e	mm ²	201
Effective core volume	V _e	mm ³	20500
Cross-sectional center pole area	A _{cp}	mm ²	174
Minimum cross-sectional center pole area	A _{cp min.}	mm ²	167
Cross-sectional winding area of core	A _{cw}	mm ²	326
Weight (approx.)		g	95

Part No.	AL-value (nH/N ²)	Core loss (W) at 100°C 100kHz, 200mT	Calculated output power (forward converter mode)
PC44PQ40/40Z-12	4300±25% (1kHz, 0.5mA)* 6200 min. (100kHz, 200mT)	6.56 max.	596W (100kHz)

* Coil: ø0.4 2UEW 100Ts

NI limit vs. AL-value for PC44PQ40/40 gapped core (Typical)

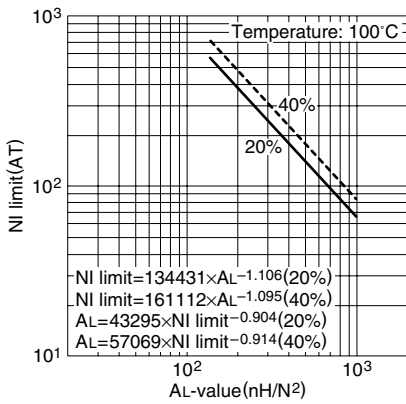

Note: NI limit shows the point where the exciting current is 20% and 40% away from its extended linear part.

AL-value vs. Air gap length for PC44PQ40/40 core (Typical)

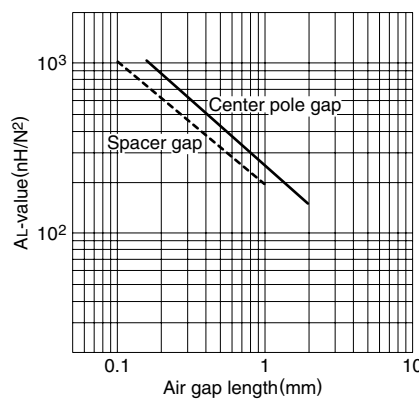

Measuring conditions • Coil: ø0.4 2UEW 100Ts
• Frequency: 1kHz
• Level: 0.5mA

Temperature rise vs. Total loss for PQ40/40 core (Typical)

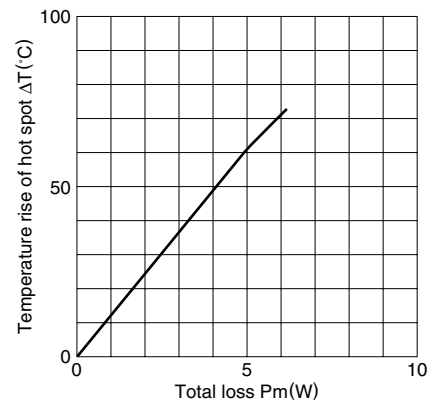

Note: The temperature rise is measured in the room whose temperature and humidity are fixed to 25°C and 45%RH, respectively. (approx. 400×300×300cm)

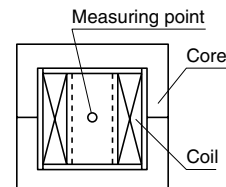

Ferrite

For Switching Power Supplies

Technical Data

PQ Series PQ50/50 Cores

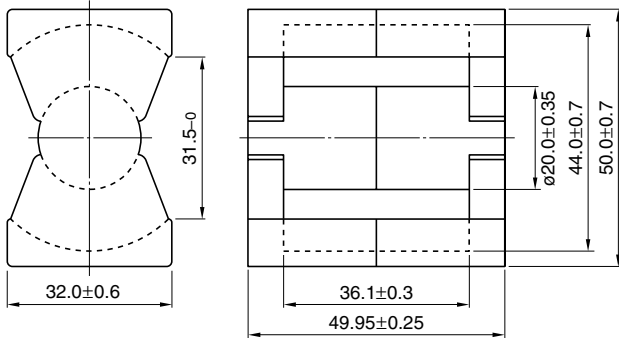

Dimensions in mm

Parameter

Core factor	C1	mm ⁻¹	0.346
Effective magnetic path length	ℓ _e	mm	113
Effective cross-sectional area	A _e	mm ²	328
Effective core volume	V _e	mm ³	37238
Cross-sectional center pole area	A _{cp}	mm ²	314
Minimum cross-sectional center pole area	A _{cp min.}	mm ²	303
Cross-sectional winding area of core	A _{cw}	mm ²	433
Weight (approx.)		g	195

Part No.	AL-value (nH/N ²)	Core loss (W) at 100°C 100kHz, 150mT	Calculated output power (forward converter mode)
PC44PQ50/50Z-12	6720±25% (1kHz, 0.5mA)* 9810 min. (100kHz, 150mT)	6.1 max.	1045W (100kHz)

* Coil: ø0.4 2UEW 100Ts

NI limit vs. AL-value for PC44PQ50/50 gapped core (Typical)

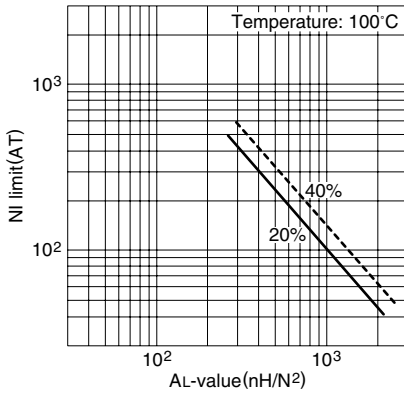

Note: NI limit shows the point where the exciting current is 20% and 40% away from its extended linear part.

AL-value vs. Air gap length for PC44PQ50/50 core (Typical)

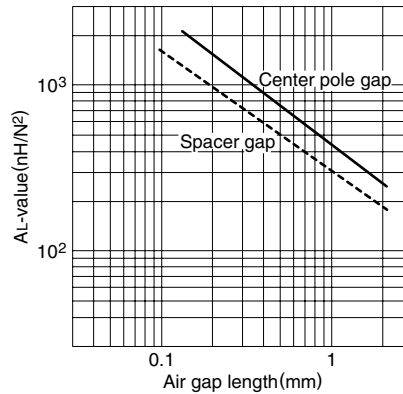

Measuring conditions • Coil: ø0.4 2UEW 100Ts
• Frequency: 1kHz
• Level: 0.5mA

Temperature rise vs. Total loss for PQ50/50 core (Typical) (Ambient temperature: 25°C)

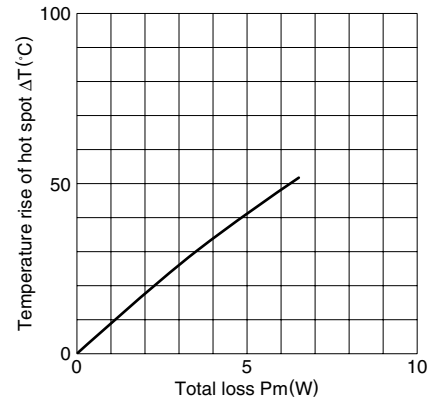

Note: The temperature rise is measured in the room whose temperature and humidity are fixed to 25°C and 45%RH, respectively. (approx. 400×300×300cm)

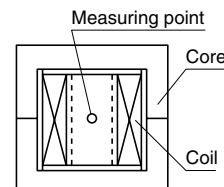

Ferrite

For Switching Power Supplies

Technical Data

LP Series LP23/8 Cores

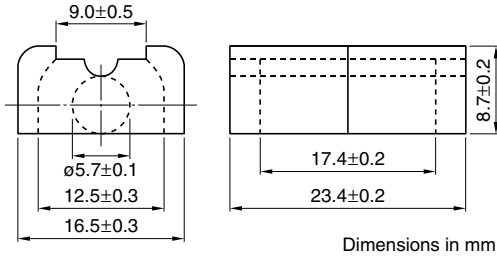

Parameter

Core factor	C1	mm ⁻¹	1.41
Effective magnetic path length	ℓ _e	mm	44.1
Effective cross-sectional area	A _e	mm ²	31.3
Effective core volume	V _e	mm ³	1380
Cross-sectional center pole area	A _{cp}	mm ²	25.5
Minimum cross-sectional center pole area	A _{cp min.}	mm ²	24.6
Cross-sectional winding area of core	A _{cw}	mm ²	59.2
Weight (approx.)		g	9.6

Part No.	AL-value (nH/N ²)	Core loss (W) at 100°C 100kHz, 200mT	Calculated output power (forward converter mode)
PC44LP23/8Z-12	1600±25% (1kHz, 0.5mA)* 2230 min. (100kHz, 200mT)	0.42 max.	50W (100kHz)

* Coil: ø0.35 2UEW 100Ts

NI limit vs. AL-value for PC44LP23/8 gapped core (Typical)

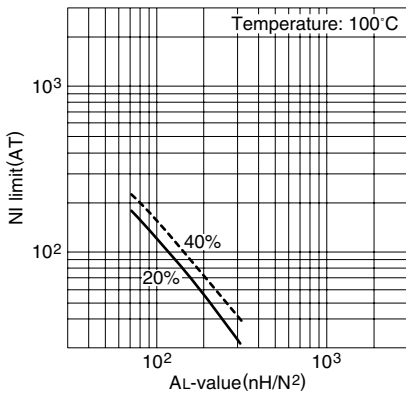

Note: NI limit shows the point where the exciting current is 20% and 40% away from its extended linear part.

AL-value vs. Air gap length for PC44LP23/8 core (Typical)

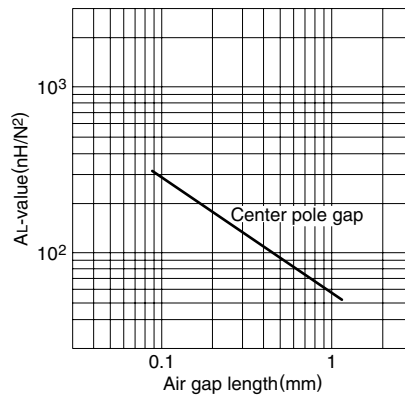

Measuring conditions • Coil: ø0.35 2UEW 100Ts
• Frequency: 1kHz
• Level: 0.5mA

Temperature rise vs. Total loss for LP23/8 core (Typical) (Ambient temperature: 25°C)

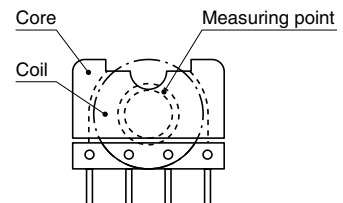
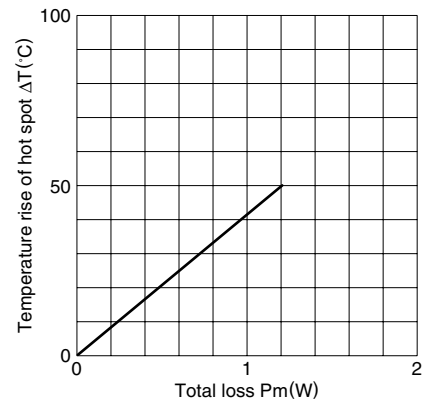

Note: The temperature rise is measured in the room whose temperature and humidity are fixed to 25°C and 45%RH, respectively. (approx. 400×300×300cm)

Ferrite

For Switching Power Supplies

Technical Data

LP Series LP22/13 Cores

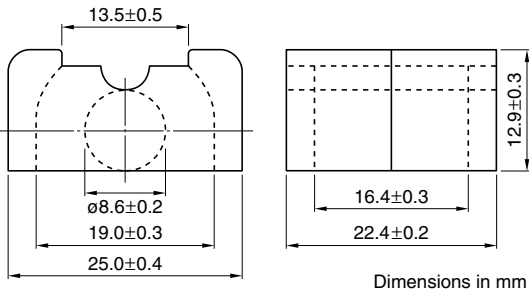

Parameter

Core factor	C1	mm ⁻¹	0.721
Effective magnetic path length	l_e	mm	49.0
Effective cross-sectional area	A_e	mm ²	67.9
Effective core volume	V_e	mm ³	3330
Cross-sectional center pole area	A_{cp}	mm ²	58.1
Minimum cross-sectional center pole area	$A_{cp \text{ min.}}$	mm ²	55.4
Cross-sectional winding area of core	A_{cw}	mm ²	84.2
Weight (approx.)		g	21

Part No.	AL-value (nH/N ²)	Core loss (W) at 100°C 100kHz, 200mT	Calculated output power (forward converter mode)
PC44LP22/13Z-12	3310±25% (1kHz, 0.5mA)* 4700 min. (100kHz, 200mT)	1.05 max.	121W (100kHz)

* Coil: ø0.35 2UEW 100Ts

NI limit vs. AL-value for PC44LP22/13 gapped core (Typical)

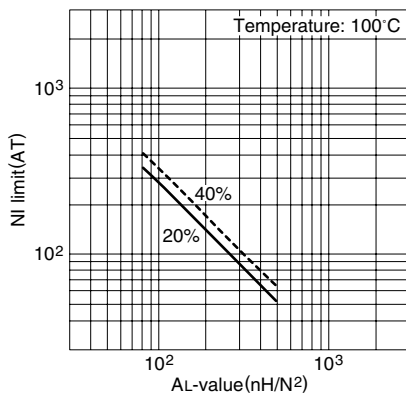

Note: NI limit shows the point where the exciting current is 20% and 40% away from its extended linear part.

AL-value vs. Air gap length for PC44LP22/13 core (Typical)

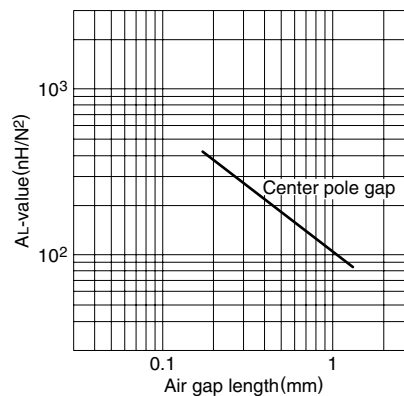

Measuring conditions • Coil: ø0.35 2UEW 100Ts
• Frequency: 1kHz
• Level: 0.5mA

Temperature rise vs. Total loss for LP22/13 core (Typical) (Ambient temperature: 25°C)

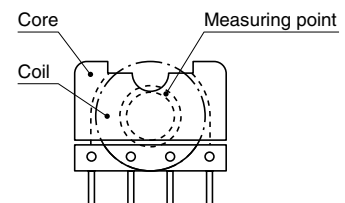
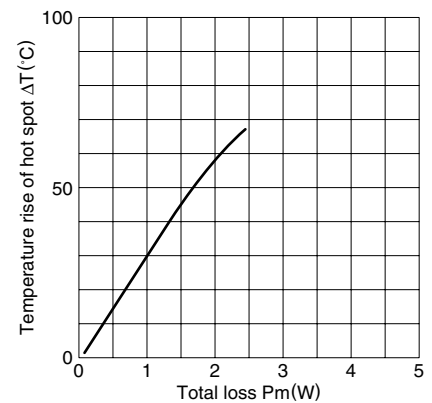

Note: The temperature rise is measured in the room whose temperature and humidity are fixed to 25°C and 45%RH, respectively. (approx. 400×300×300cm)

Ferrite

For Switching Power Supplies

Technical Data

LP Series LP32/13 Cores

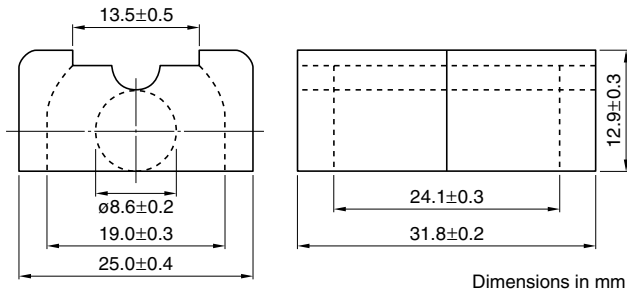

Parameter

Core factor	C1	mm ⁻¹	0.909
Effective magnetic path length	ℓ _e	mm	64.0
Effective cross-sectional area	A _e	mm ²	70.3
Effective core volume	V _e	mm ³	4500
Cross-sectional center pole area	A _{cp}	mm ²	58.1
Minimum cross-sectional center pole area	A _{cp min.}	mm ²	55.4
Cross-sectional winding area of core	A _{cw}	mm ²	125.3
Weight (approx.)		g	30

Part No.	AL-value (nH/N ²)	Core loss (W) at 100°C	Calculated output power
		100kHz, 200mT	(forward converter mode)
PC44LP32/13Z-12	2630±25% (1kHz, 0.5mA)* 3730 min. (100kHz, 200mT)	1.38 max.	164W (100kHz)

* Coil: ø0.35 2UEW 100Ts

NI limit vs. AL-value for PC44LP32/13 gapped core (Typical)

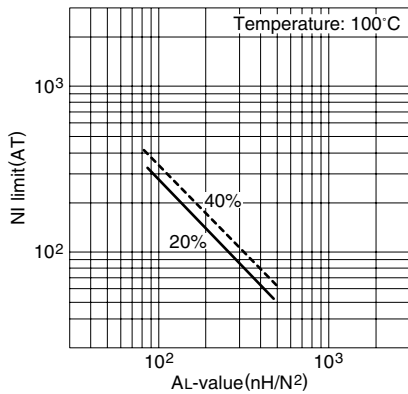

Note: NI limit shows the point where the exciting current is 20% and 40% away from its extended linear part.

AL-value vs. Air gap length for PC44LP32/13core (Typical)

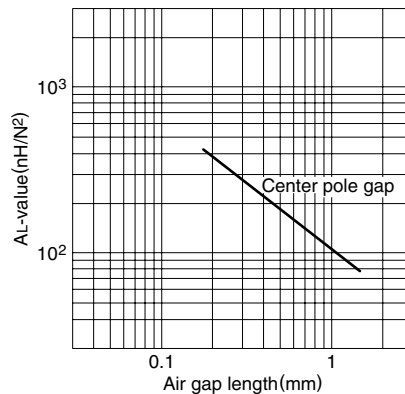

Measuring conditions • Coil: ø0.35 2UEW 100Ts
• Frequency: 1kHz
• Level: 0.5mA

Temperature rise vs. Total loss for LP32/13 core (Typical) (Ambient temperature: 25°C)

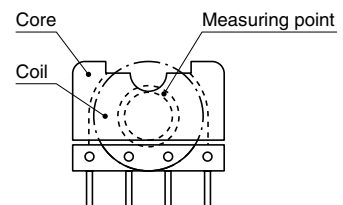
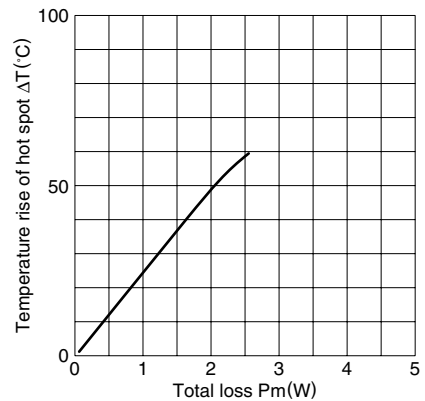

Note: The temperature rise is measured in the room whose temperature and humidity are fixed to 25°C and 45(%RH), respectively. (approx. 400×300×300cm)

Ferrite

For Switching Power Supplies

Technical Data

RM Series RM4 Cores

Based on JIS C 2516, IEC publication 431 and DIN 41980.

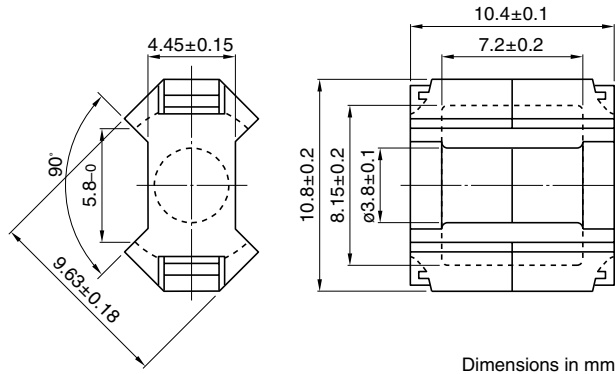

Parameter

Core factor	C1	mm ⁻¹	1.62
Effective magnetic path length	ℓ _e	mm	22.7
Effective cross-sectional area	A _e	mm ²	14.0
Effective core volume	V _e	mm ³	318
Cross-sectional center pole area	A _{cp}	mm ²	11.3
Minimum cross-sectional center pole area	A _{cp min.}	mm ²	10.7
Cross-sectional winding area of core	A _{cw}	mm ²	15.6
Weight (approx.)		g	1.7

Part No.	AL-value (nH/N ²)	Core loss (W) at 100°C		Calculated output power (forward converter mode)
		100kHz, 200mT	500kHz, 50mT	
PC40RM4Z-12	680 min. (1kHz, 0.5mA)* 1650 min. (100kHz, 200mT)	0.12 max.		6.9W (100kHz)
PC50RM4Z-12	960±25% (1kHz, 0.5mA)*	0.036 max.		21W (500kHz)

* Coil: ø0.18 2UEW 100Ts

NI limit vs. AL-value for PC40RM4 gapped core (Typical)

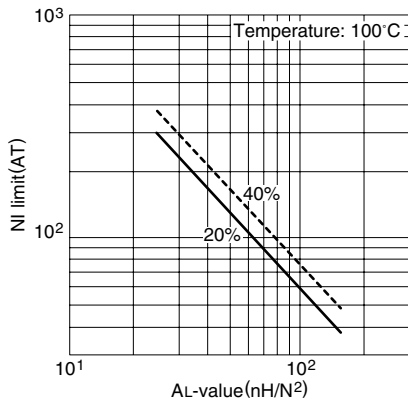

AL-value vs. Air gap length for PC40RM4 core (Typical)

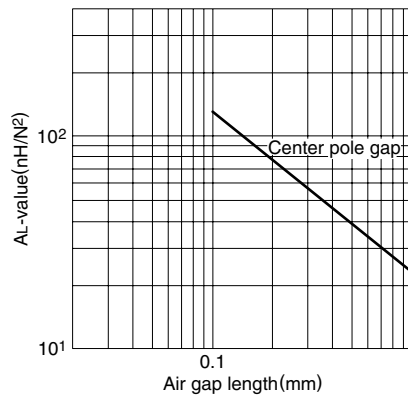

Temperature rise vs. Total loss for RM4 core (Typical) (Ambient temperature: 25°C)

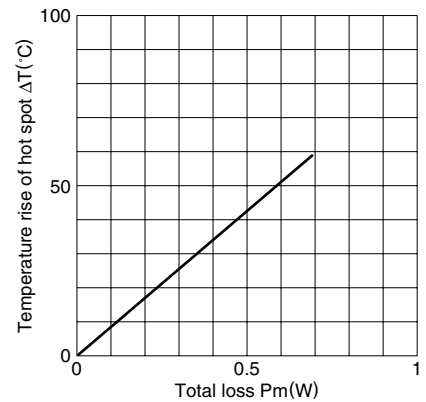

Note: The temperature rise is measured in the room whose temperature and humidity are fixed to 25°C and 45(%RH), respectively. (approx. 400×300×300cm)

NI limit vs. AL-value for PC50RM4 gapped core (Typical)

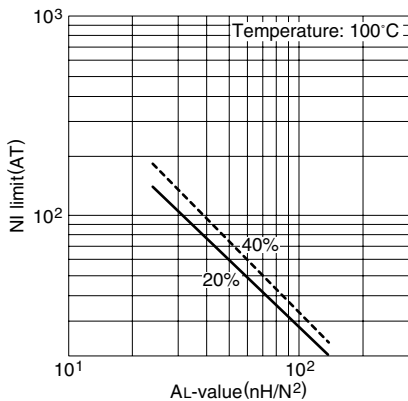

AL-value vs. Air gap length for PC50RM4 core (Typical)

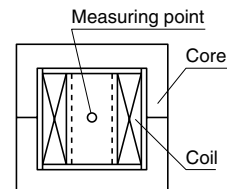
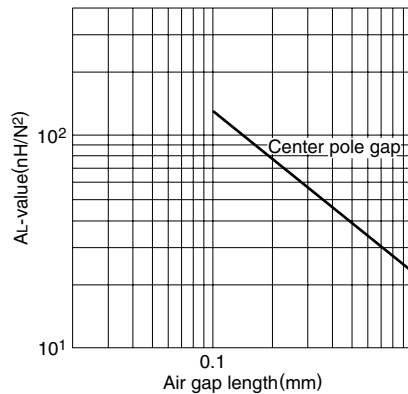

Note: NI limit shows the point where the exciting current is 20% and 40% away from its extended linear part.

Measuring conditions • Coil: ø0.18 2UEW 100Ts
• Frequency: 1kHz
• Level: 0.5mA

Ferrite

For Switching Power Supplies

Technical Data

RM Series RM5 Cores

Based on JIS C 2516, IEC publication 431 and DIN 41980.

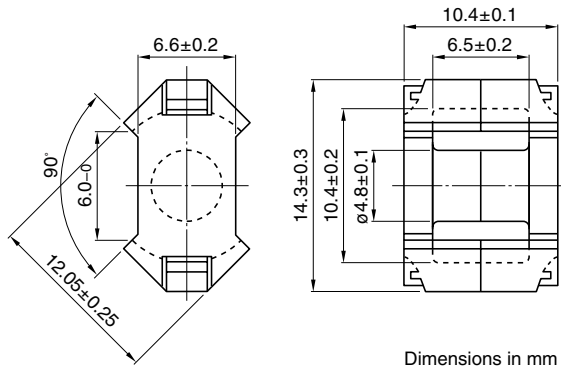

Parameter

Core factor	C1	mm ⁻¹	0.940
Effective magnetic path length	ℓ _e	mm	22.4
Effective cross-sectional area	A _e	mm ²	23.7
Effective core volume	V _e	mm ³	530
Cross-sectional center pole area	A _{cp}	mm ²	18.1
Minimum cross-sectional center pole area	A _{cp min.}	mm ²	17.3
Cross-sectional winding area of core	A _{cw}	mm ²	18.2
Weight (approx.)		g	3.0

Part No.	AL-value (nH/N ²)	Core loss (W) at 100°C		Calculated output power (forward converter mode)
		100kHz, 200mT	500kHz, 50mT	
PC40RM5Z-12	1250 min. (1kHz, 0.5mA)* 3340 min. (100kHz, 200mT)	0.18 max.		16W (100kHz)
PC50RM5Z-12	1340±25% (1kHz, 0.5mA)*	0.053 max.		34W (500kHz)

* Coil: ø0.2 2UEW 100Ts

NI limit vs. AL-value for PC40RM5 gapped core (Typical)

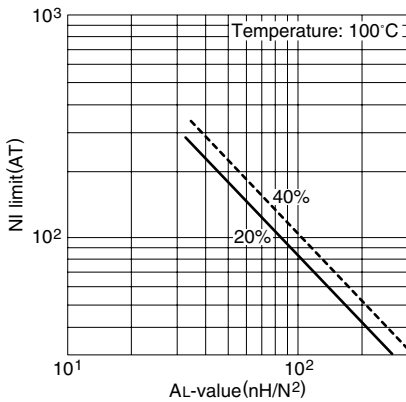

AL-value vs. Air gap length for PC40RM5 core (Typical)

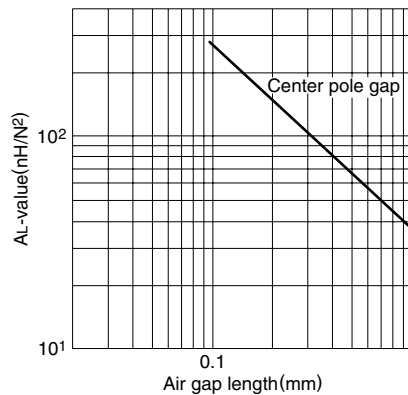

Temperature rise vs. Total loss for RM5 core (Typical) (Ambient temperature: 25°C)

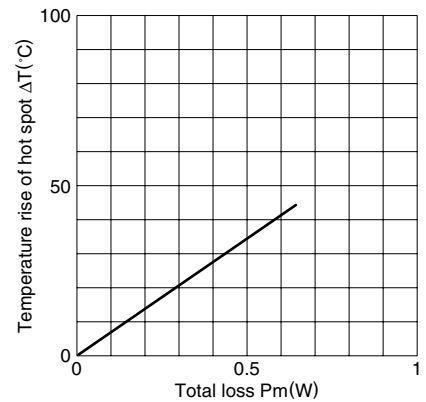

Note: The temperature rise is measured in the room whose temperature and humidity are fixed to 25°C and 45(%RH), respectively. (approx. 400×300×300cm)

NI limit vs. AL-value for PC50RM5 gapped core (Typical)

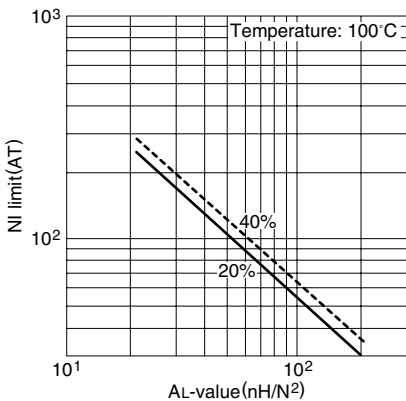

AL-value vs. Air gap length for PC50RM5 core (Typical)

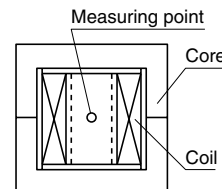
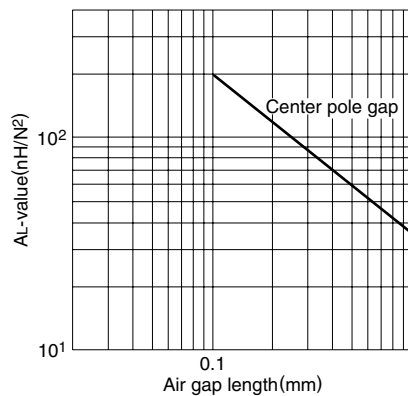

Note: NI limit shows the point where the exciting current is 20% and 40% away from its extended linear part.

Measuring conditions • Coil: ø0.2 2UEW 100Ts
• Frequency: 1kHz
• Level: 0.5mA

Ferrite

For Switching Power Supplies

Technical Data

RM Series RM6 Cores

Based on JIS C 2516, IEC publication 431 and DIN 41980.

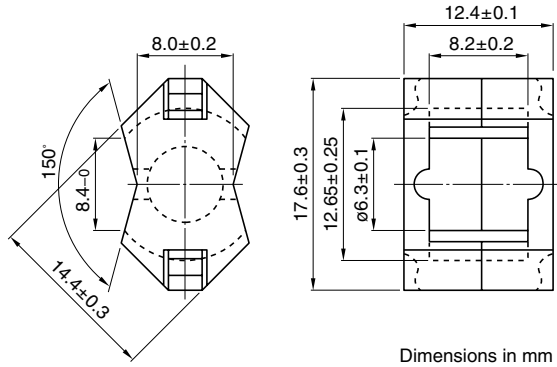

Parameter

Core factor	C1	mm ⁻¹	0.781
Effective magnetic path length	ℓ _e	mm	28.6
Effective cross-sectional area	A _e	mm ²	36.6
Effective core volume	V _e	mm ³	1050
Cross-sectional center pole area	A _{cp}	mm ²	31.2
Minimum cross-sectional center pole area	A _{cp min.}	mm ²	30.2
Cross-sectional winding area of core	A _{cw}	mm ²	26.0
Weight (approx.)		g	5.5

Part No.	AL-value (nH/N ²)	Core loss (W) at 100°C		Calculated output power (forward converter mode)
		100kHz, 200mT	500kHz, 50mT	
PC40RM6Z-12	1830 min. (1kHz, 0.5mA)* 4030 min. (100kHz, 200mT)	0.41 max.		27W (100kHz)
PC50RM6Z-12	1700±25% (1kHz, 0.5mA)*	0.11 max.		55W (500kHz)

* Coil: ø0.26 2UEW 100Ts

NI limit vs. AL-value for PC40RM6 gapped core (Typical)

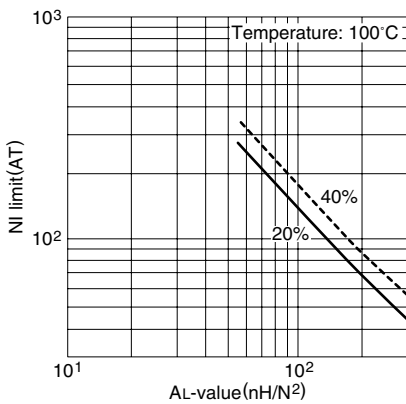

AL-value vs. Air gap length for PC40RM6 core (Typical)

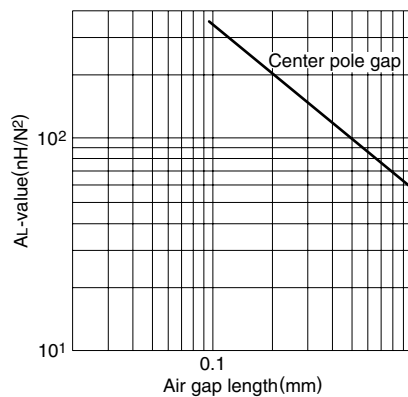

Temperature rise vs. Total loss for RM6 core (Typical) (Ambient temperature: 25°C)

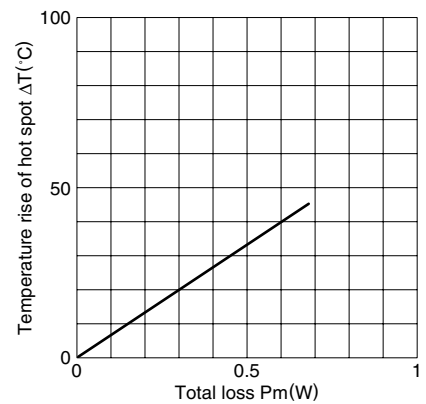

Note: The temperature rise is measured in the room whose temperature and humidity are fixed to 25°C and 45(%RH), respectively. (approx. 400×300×300cm)

NI limit vs. AL-value for PC50RM6 gapped core (Typical)

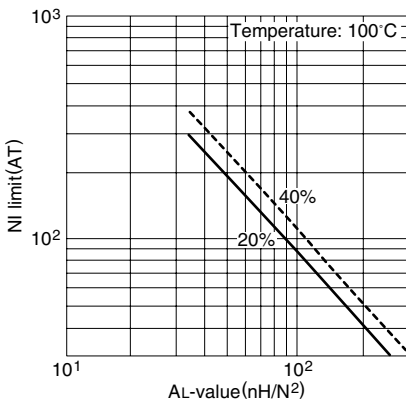

AL-value vs. Air gap length for PC50RM6 core (Typical)

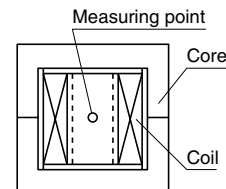
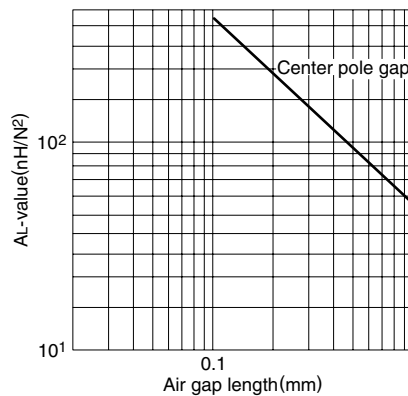

Note: NI limit shows the point where the exciting current is 20% and 40% away from its extended linear part.

Measuring conditions • Coil: ø0.26 2UEW 100Ts
• Frequency: 1kHz
• Level: 0.5mA

Ferrite

For Switching Power Supplies

Technical Data

RM Series RM8 Cores

Based on JIS C 2516, IEC publication 431 and DIN 41980.

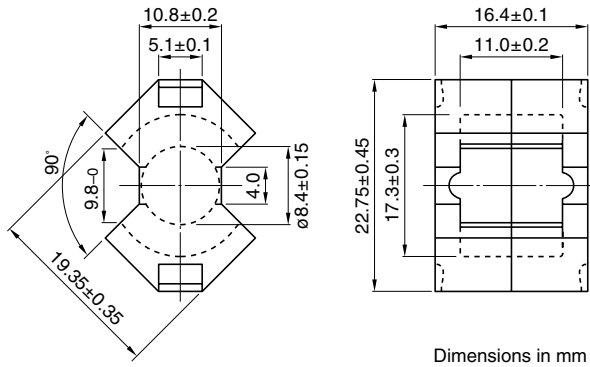

Parameter

Core factor	C1	mm ⁻¹	0.594
Effective magnetic path length	ℓ _e	mm	38
Effective cross-sectional area	A _e	mm ²	64
Effective core volume	V _e	mm ³	2430
Cross-sectional center pole area	A _{cp}	mm ²	55.4
Minimum cross-sectional center pole area	A _{cp min.}	mm ²	53.5
Cross-sectional winding area of core	A _{cw}	mm ²	48.9
Weight (approx.)		g	13

Part No.	AL-value (nH/N ²)	Core loss (W) at 100°C	Calculated output power
		100kHz, 200mT	(forward converter mode)
PC40RM8Z-12	1950 min. (1kHz, 0.5mA)* 5290 min. (100kHz, 200mT)	0.97 max.	67W (100kHz)

* Coil: ø0.4 2UEW 100Ts

NI limit vs. AL-value for PC40RM8 gapped core (Typical)

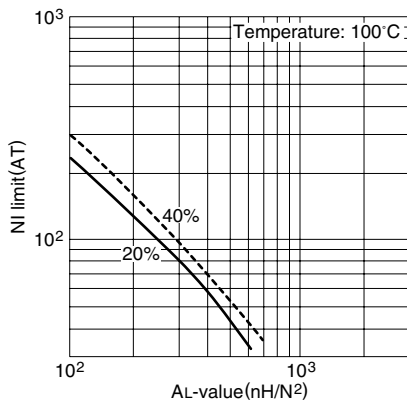

Note: NI limit shows the point where the exciting current is 20% and 40% away from its extended linear part.

AL-value vs. Air gap length for PC40RM8 core (Typical)

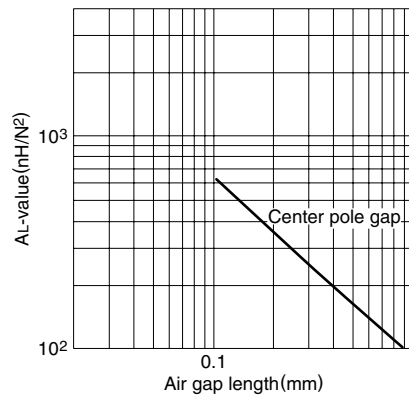

Measuring conditions • Coil: ø0.4 2UEW 100Ts
• Frequency: 1kHz
• Level: 0.5mA

Temperature rise vs. Total loss for RM8 core (Typical) (Ambient temperature: 25°C)

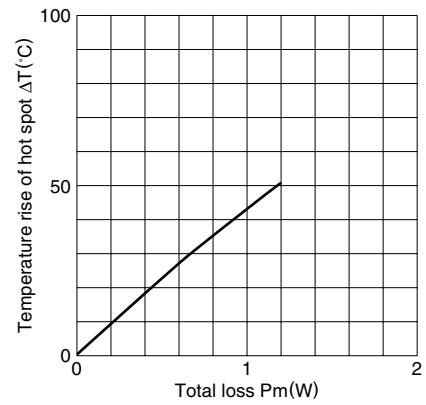

Note: The temperature rise is measured in the room whose temperature and humidity are fixed to 25°C and 45(%RH), respectively. (approx. 400×300×300cm)

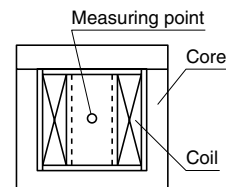

Ferrite

For Switching Power Supplies

Technical Data

RM Series RM10 Cores

Based on JIS C 2516, IEC publication 431 and DIN 41980.

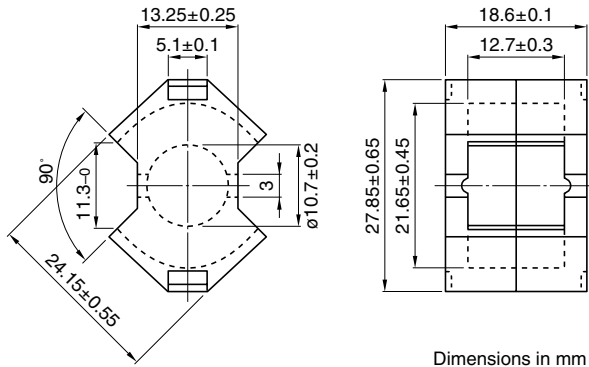

Parameter

Core factor	C1	mm ⁻¹	0.450
Effective magnetic path length	ℓ _e	mm	44.0
Effective cross-sectional area	A _e	mm ²	98.0
Effective core volume	V _e	mm ³	4310
Cross-sectional center pole area	A _{cp}	mm ²	89.9
Minimum cross-sectional center pole area	A _{cp min.}	mm ²	86.6
Cross-sectional winding area of core	A _{cw}	mm ²	69.5
Weight (approx.)		g	23

Part No.	AL-value (nH/N ²)	Core loss (W) at 100°C	Calculated output power
		100kHz, 200mT	(forward converter mode)
PC40RM10Z-12	3630 min. (1kHz, 0.5mA)* 7000 min. (100kHz, 200mT)	1.8 max.	130W (100kHz)

* Coil: ø0.4 2UEW 100Ts

NI limit vs. AL-value for PC40RM10 gapped core (Typical)

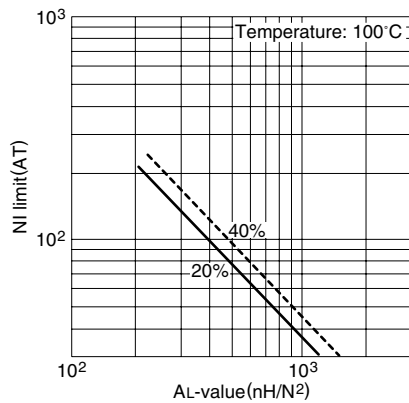

Note: NI limit shows the point where the exciting current is 20% and 40% away from its extended linear part.

AL-value vs. Air gap length for PC40RM10 core (Typical)

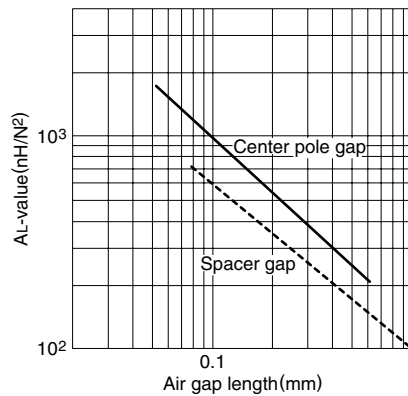

Measuring conditions • Coil: ø0.4 2UEW 100Ts
• Frequency: 1kHz
• Level: 0.5mA

Temperature rise vs. Total loss for RM10 core (Typical) (Ambient temperature: 25°C)

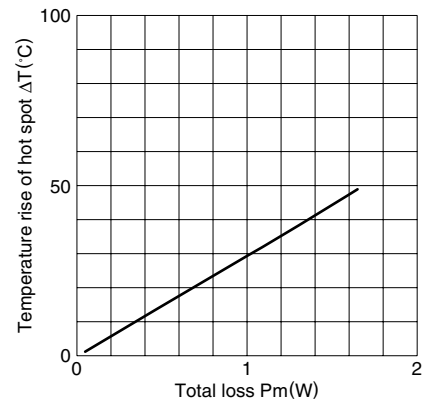

Note: The temperature rise is measured in the room whose temperature and humidity are fixed to 25°C and 45(%RH), respectively. (approx. 400×300×300cm)

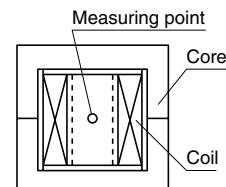

Ferrite

For Switching Power Supplies

Technical Data

RM Series RM12 Cores

Based on JIS C 2516.

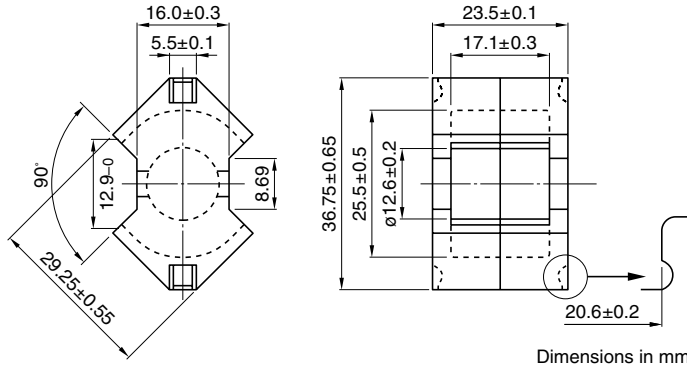

Parameter

Core factor	C1	mm ⁻¹	0.406
Effective magnetic path length	ℓ _e	mm	56.9
Effective cross-sectional area	A _e	mm ²	140
Effective core volume	V _e	mm ³	7960
Cross-sectional center pole area	A _{cp}	mm ²	125
Minimum cross-sectional center pole area	A _{cp min.}	mm ²	121
Cross-sectional winding area of core	A _{cw}	mm ²	110
Weight (approx.)		g	42

Part No.	AL-value (nH/N ²)	Core loss (W) at 100°C	Calculated output power
		100kHz, 200mT	(forward converter mode)
PC40RM12Z-12	4150 min. (1kHz, 0.5mA)* 9290 min. (100kHz, 200mT)	3.3 max.	344W (100kHz)

* Coil: ø0.4 2UEW 100Ts

NI limit vs. AL-value for PC40RM12 gapped core (Typical)

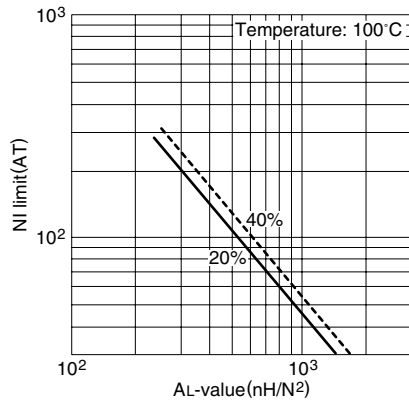

Note: NI limit shows the point where the exciting current is 20% and 40% away from its extended linear part.

AL-value vs. Air gap length for PC40RM12 core (Typical)

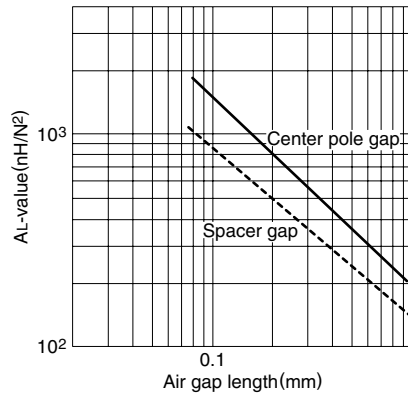

Measuring conditions • Coil: ø0.4 2UEW 100Ts
• Frequency: 1kHz
• Level: 0.5mA

Temperature rise vs. Total loss for RM12 core (Typical) (Ambient temperature: 25°C)

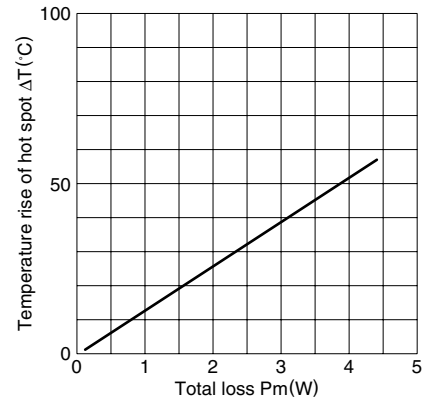

Note: The temperature rise is measured in the room whose temperature and humidity are fixed to 25°C and 45(%RH), respectively. (approx. 400×300×300cm)

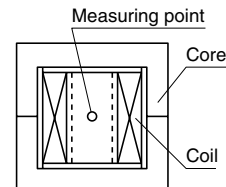

Ferrite

For Switching Power Supplies

Technical Data

RM Series RM14 Cores

Based on JIS C 2516, IEC publication 431 and DIN 41980.

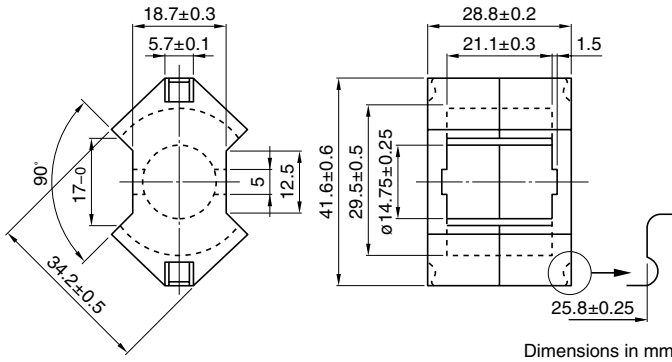

Parameter

Core factor	C1	mm ⁻¹	0.393
Effective magnetic path length	ℓ _e	mm	70.0
Effective cross-sectional area	A _e	mm ²	178
Effective core volume	V _e	mm ³	12500
Cross-sectional center pole area	A _{cp}	mm ²	171
Minimum cross-sectional center pole area	A _{cp min.}	mm ²	165
Cross-sectional winding area of core	A _{cw}	mm ²	155
Weight (approx.)		g	70

Part No.	AL-value (nH/N ²)	Core loss (W) at 100°C	Calculated output power
		100kHz, 200mT	(forward converter mode)
PC40RM14Z-12	4600 min. (1kHz, 0.5mA)* 9590 min. (100kHz, 200mT)	4.75 max.	376W (100kHz)

* Coil: ø0.4 2UEW 100Ts

NI limit vs. AL-value for PC40RM14 gapped core (Typical)

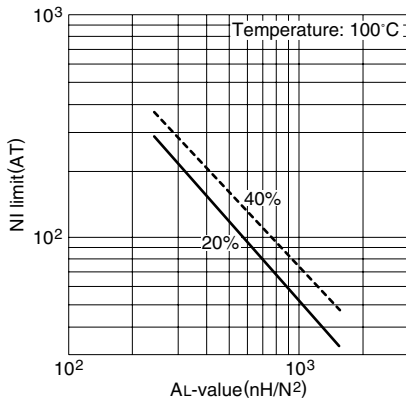

Note: NI limit shows the point where the exciting current is 20% and 40% away from its extended linear part.

AL-value vs. Air gap length for PC40RM14 core (Typical)

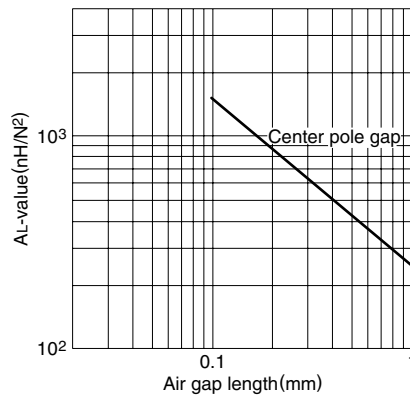

Measuring conditions • Coil: ø0.4 2UEW 100Ts
• Frequency: 1kHz
• Level: 0.5mA

Temperature rise vs. Total loss for RM14 core (Typical)
(Ambient temperature: 25°C)

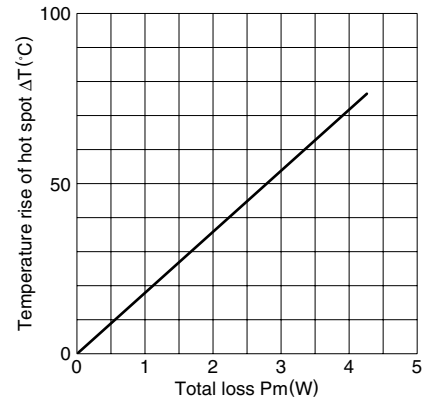

Note: The temperature rise is measured in the room whose temperature and humidity are fixed to 25°C and 45%RH, respectively. (approx. 400×300×300cm)

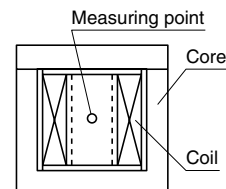

Ferrite

For Switching Power Supplies

Technical Data

EPC Series EPC10 Cores

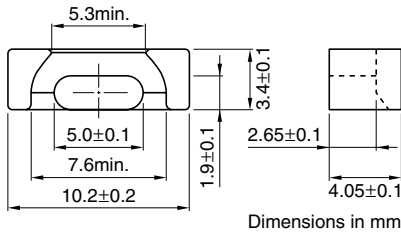

Parameter

Core factor	C1	mm ⁻¹	1.89
Effective magnetic path length	ℓ _e	mm	17.8
Effective cross-sectional area	A _e	mm ²	9.39
Effective core volume	V _e	mm ³	167
Cross-sectional center pole area	A _{cp}	mm ²	8.73
Minimum cross-sectional area	A _{cp min.}	mm ²	8.13
Cross-sectional winding area of core	A _{cw}	mm ²	7.69
Weight (approx.)		g	1.1

Part No.	AL-value (nH/N ²)	Core loss (W) at 100°C		Calculated output power (forward converter mode)
		100kHz, 200mT	500kHz, 50mT	
PC44EPC10-Z	1000±25% (1kHz, 0.5mA)*	0.072 max.		5.4W (100kHz)
PC50EPC10-Z	660±25% (1kHz, 0.5mA)*	0.025 max.		13W (500kHz)

* Coil: ø0.1 2UEW 100Ts

NI limit vs. AL-value for PC44EPC10 gapped core (Typical)

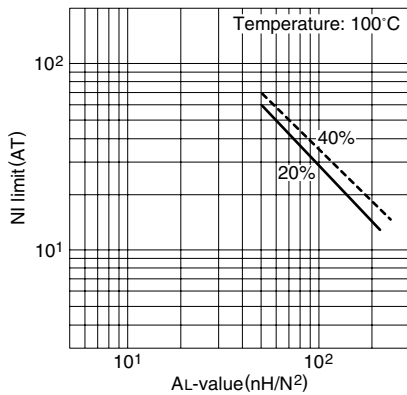

AL-value vs. Air gap length for PC44EPC10 core (Typical)

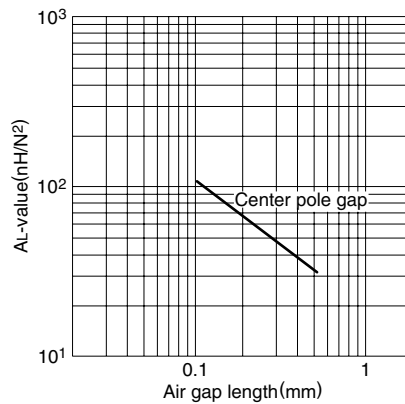

Temperature rise vs. Total loss for EPC10 core (Typical) (Ambient temperature: 25°C)

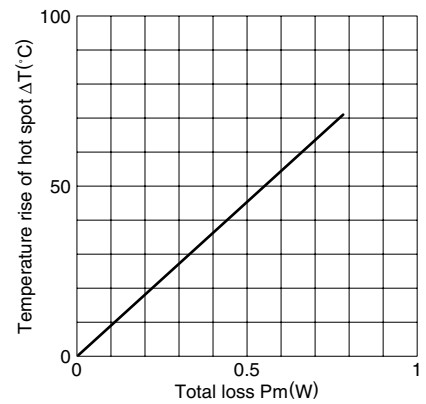

Note: The temperature rise is measured in the room whose temperature and humidity are fixed to 25°C and 45%RH, respectively. (approx. 400×300×300cm)

NI limit vs. AL-value for PC50EPC10 gapped core (Typical)

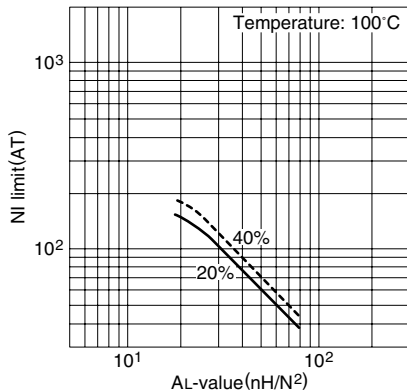

AL-value vs. Air gap length for PC50EPC10 core (Typical)

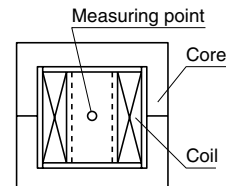
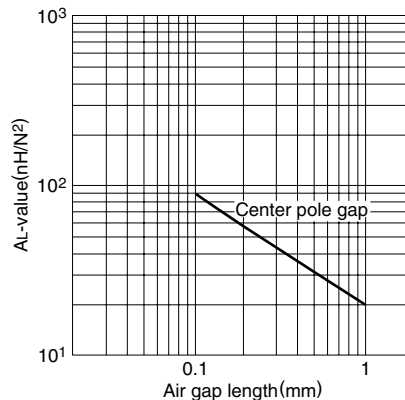

Note: NI limit shows the point where the exciting current is 20% and 40% away from its extended linear part.

Measuring conditions • Coil: ø0.1 2UEW 100Ts
• Frequency: 1kHz
• Level: 0.5mA

Ferrite

For Switching Power Supplies

Technical Data

EPC Series EPC13 Cores

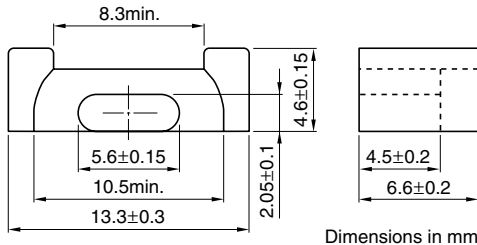

Parameter

Core factor	C1	mm ⁻¹	2.45
Effective magnetic path length	ℓ _e	mm	30.6
Effective cross-sectional area	A _e	mm ²	12.5
Effective core volume	V _e	mm ³	382
Cross-sectional center pole area	A _{cp}	mm ²	10.6
Minimum cross-sectional area	A _{cp min.}	mm ²	9.71
Cross-sectional winding area of core	A _{cw}	mm ²	23.0
Weight (approx.)		g	2.1

Part No.	AL-value (nH/N ²)	Core loss (W) at 100°C		Calculated output power (forward converter mode)
		100kHz, 200mT	500kHz, 50mT	
PC44EPC13-Z	870±25% (1kHz, 0.5mA)*	0.14 max.		8W (100kHz)
PC50EPC13-Z	560±25% (1kHz, 0.5mA)*	0.039 max.		19W (500kHz)

* Coil: ø0.2 2UEW 100Ts

NI limit vs. AL-value for PC44EPC13 gapped core (Typical)

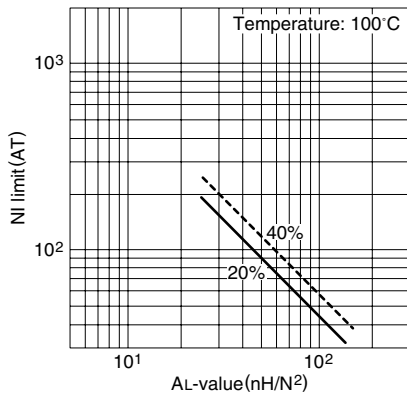

AL-value vs. Air gap length for PC44EPC13 core (Typical)

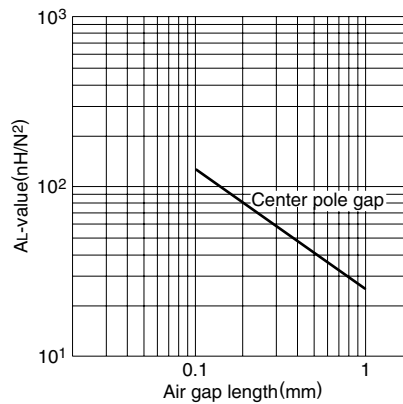

Temperature rise vs. Total loss for EPC13 core (Typical) (Ambient temperature: 25°C)

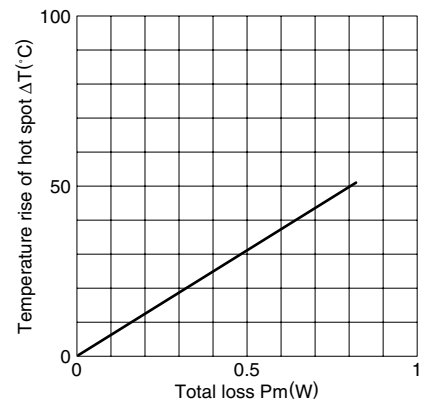

Note: The temperature rise is measured in the room whose temperature and humidity are fixed to 25°C and 45%RH, respectively. (approx. 400×300×300cm)

NI limit vs. AL-value for PC50EPC13 gapped core (Typical)

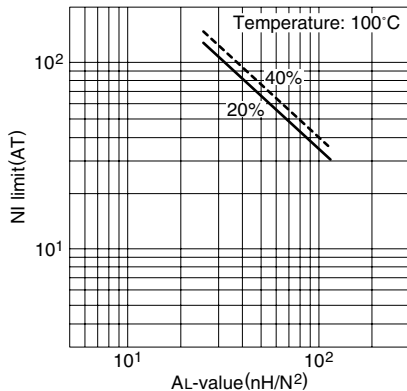

AL-value vs. Air gap length for PC50EPC13 core (Typical)

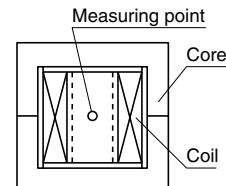
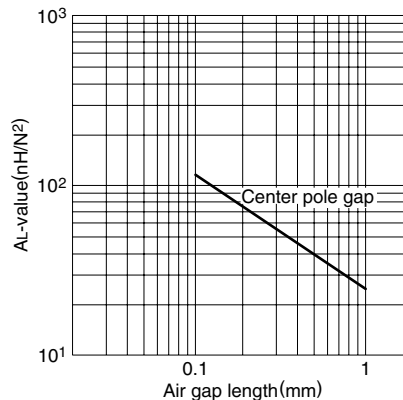

Note: NI limit shows the point where the exciting current is 20% and 40% away from its extended linear part.

Measuring conditions • Coil: ø0.2 2UEW 100Ts
• Frequency: 1kHz
• Level: 0.5mA

Ferrite

For Switching Power Supplies

Technical Data

EPC Series EPC17 Cores

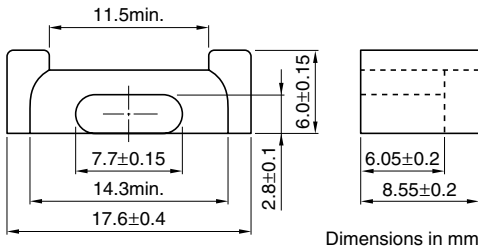

Parameter

Core factor	C1	mm ⁻¹	1.76
Effective magnetic path length	ℓ _e	mm	40.2
Effective cross-sectional area	A _e	mm ²	22.8
Effective core volume	V _e	mm ³	917
Cross-sectional center pole area	A _{cp}	mm ²	19.9
Minimum cross-sectional area	A _{cp min.}	mm ²	19.9
Cross-sectional winding area of core	A _{cw}	mm ²	18.7
Weight (approx.)		g	4.5

Part No.	AL-value (nH/N ²)	Core loss (W) at 100°C		Calculated output power (forward converter mode)
		100kHz, 200mT	500kHz, 50mT	
PC44EPC17-Z	1150±25% (1kHz, 0.5mA)*	0.35 max.		20W (100kHz)
PC50EPC17-Z	740±25% (1kHz, 0.5mA)*	0.10 max.		35W (500kHz)

* Coil: ø0.2 2UEW 100Ts

NI limit vs. AL-value for PC44EPC17 gapped core (Typical)

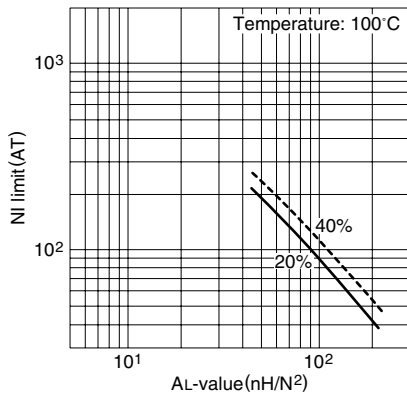

AL-value vs. Air gap length for PC44EPC17 core (Typical)

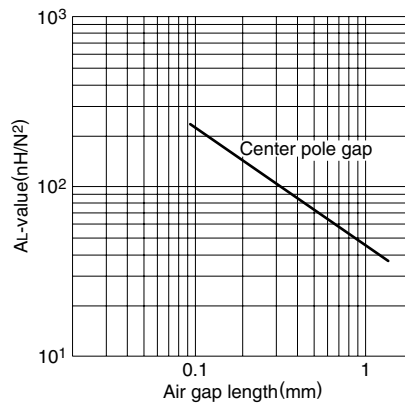

Temperature rise vs. Total loss for EPC17 core (Typical) (Ambient temperature: 25°C)

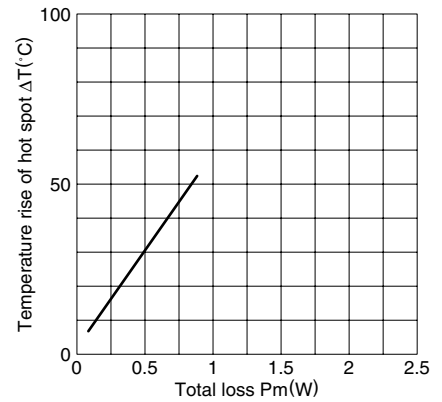

Note: The temperature rise is measured in the room whose temperature and humidity are fixed to 25°C and 45%RH, respectively. (approx. 400×300×300cm)

NI limit vs. AL-value for PC50EPC17 gapped core (Typical)

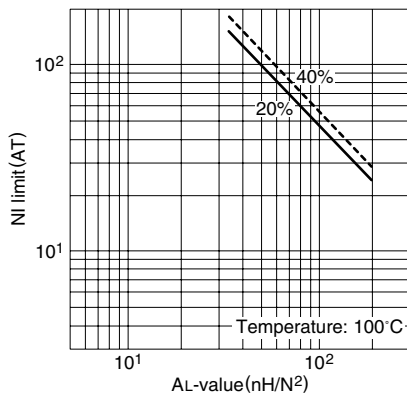

AL-value vs. Air gap length for PC50EPC17 core (Typical)

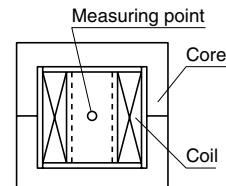
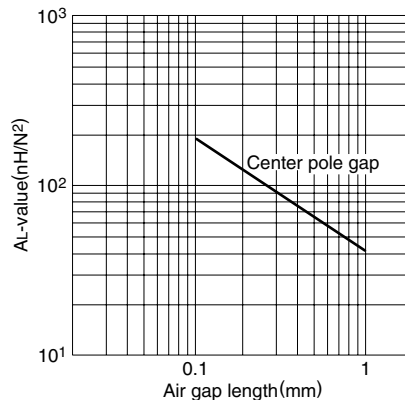

Note: NI limit shows the point where the exciting current is 20% and 40% away from its extended linear part.

Measuring conditions • Coil: ø0.2 2UEW 100Ts
• Frequency: 1kHz
• Level: 0.5mA

Ferrite

For Switching Power Supplies

Technical Data

EPC Series EPC19 Cores

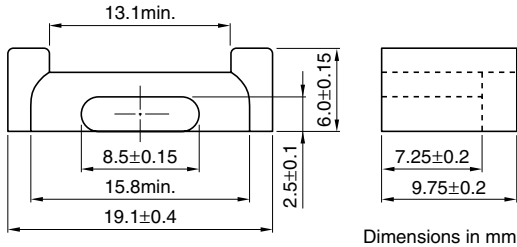

Parameter

Core factor	C1	mm ⁻¹	2.03
Effective magnetic path length	ℓ _e	mm	46.1
Effective cross-sectional area	A _e	mm ²	22.7
Effective core volume	V _e	mm ³	1050
Cross-sectional center pole area	A _{cp}	mm ²	19.9
Minimum cross-sectional area	A _{cp min.}	mm ²	18.7
Cross-sectional winding area of core	A _{cw}	mm ²	54.4
Weight (approx.)		g	5.3

Part No.	AL-value (nH/N ²)	Core loss (W) at 100°C		Calculated output power (forward converter mode)
		100kHz, 200mT	500kHz, 50mT	
PC44EPC19-Z	940±25% (1kHz, 0.5mA)*	0.4 max.		27W (100kHz)
PC50EPC19-Z	680±25% (1kHz, 0.5mA)*	0.12 max.		55W (500kHz)

* Coil: ø0.2 2UEW 100Ts

NI limit vs. AL-value for PC44EPC19 gapped core (Typical)

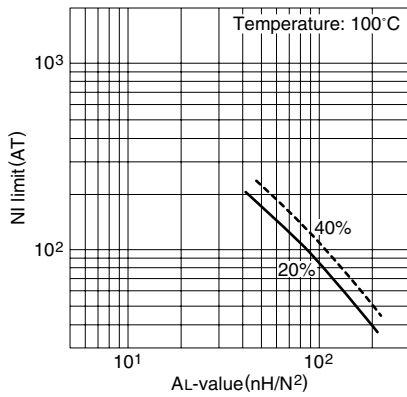

AL-value vs. Air gap length for PC44EPC19 core (Typical)

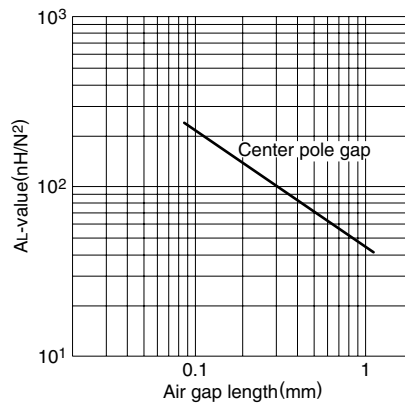

Temperature rise vs. Total loss for EPC19 core (Typical) (Ambient temperature: 25°C)

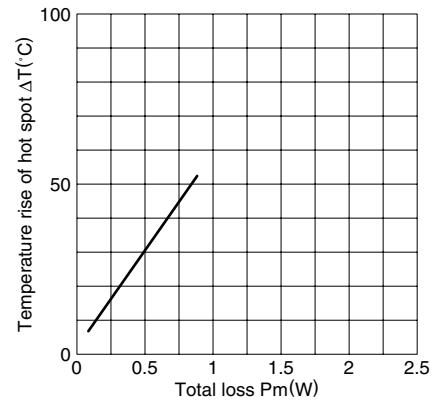

Note: The temperature rise is measured in the room whose temperature and humidity are fixed to 25°C and 45%RH, respectively. (approx. 400×300×300cm)

NI limit vs. AL-value for PC50EPC19 gapped core (Typical)

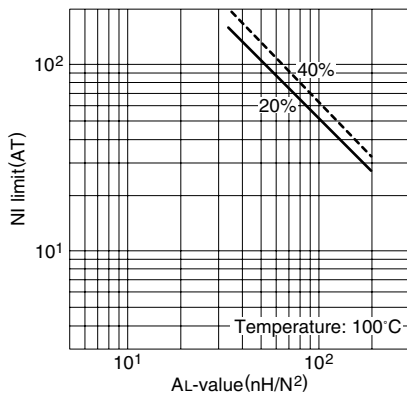

AL-value vs. Air gap length for PC50EPC19 core (Typical)

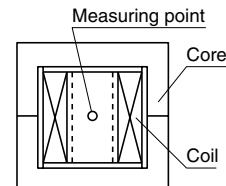
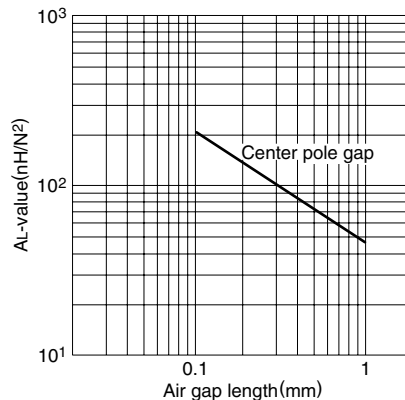

Note: NI limit shows the point where the exciting current is 20% and 40% away from its extended linear part.

Measuring conditions • Coil: ø0.2 2UEW 100Ts
• Frequency: 1kHz
• Level: 0.5mA

Ferrite

For Switching Power Supplies

Technical Data

EPC Series EPC25 Cores

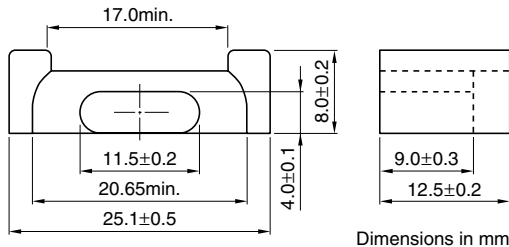

Parameter

Core factor	C1	mm ⁻¹	1.28
Effective magnetic path length	ℓ _e	mm	59.2
Effective cross-sectional area	A _e	mm ²	46.4
Effective core volume	V _e	mm ³	2750
Cross-sectional center pole area	A _{cp}	mm ²	42.6
Minimum cross-sectional area	A _{cp min.}	mm ²	40.6
Cross-sectional winding area of core	A _{cw}	mm ²	85.5
Weight (approx.)		g	13

Part No.	AL-value (nH/N ²)	Core loss (W) at 100°C		Calculated output power (forward converter mode)
		100kHz, 200mT	500kHz, 50mT	
PC44EPC25-Z	1560±25% (1kHz, 0.5mA)*	1.11 max.		63W (100kHz)
PC50EPC25-Z	1080±25% (1kHz, 0.5mA)*	0.32 max.		127W (500kHz)

* Coil: ø0.2 2UEW 100Ts

NI limit vs. AL-value for PC44EPC25 gapped core (Typical)

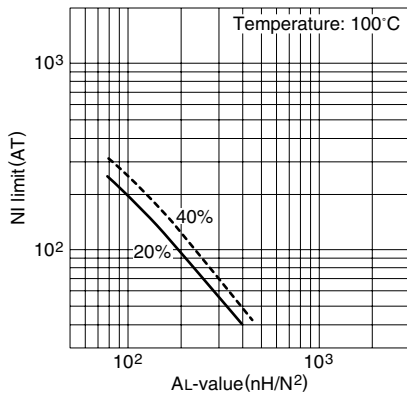

AL-value vs. Air gap length for PC44EPC25 core (Typical)

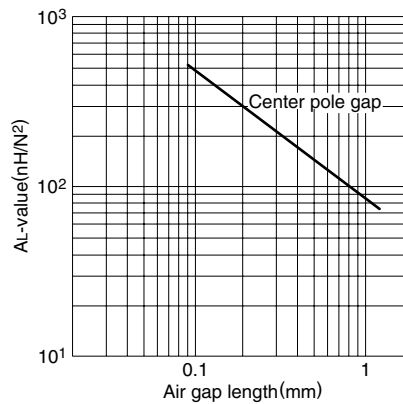

Temperature rise vs. Total loss for EPC25 core (Typical) (Ambient temperature: 25°C)

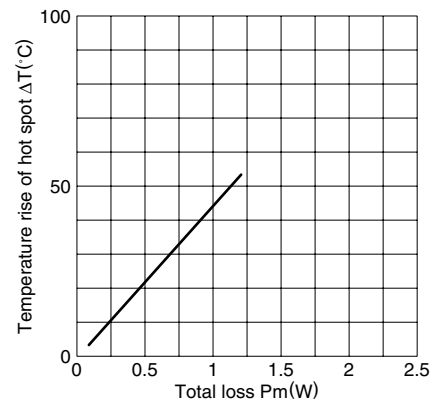

Note: The temperature rise is measured in the room whose temperature and humidity are fixed to 25°C and 45%RH, respectively. (approx. 400×300×300cm)

NI limit vs. AL-value for PC50EPC25 gapped core (Typical)

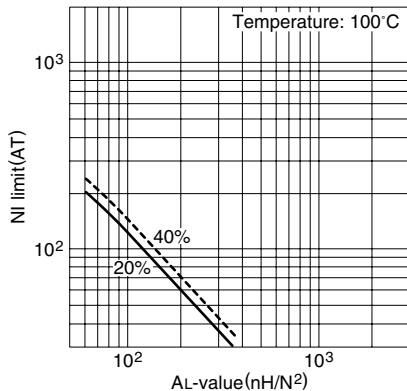

AL-value vs. Air gap length for PC50EPC25 core (Typical)

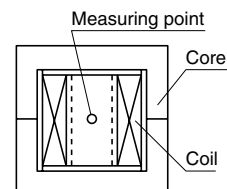
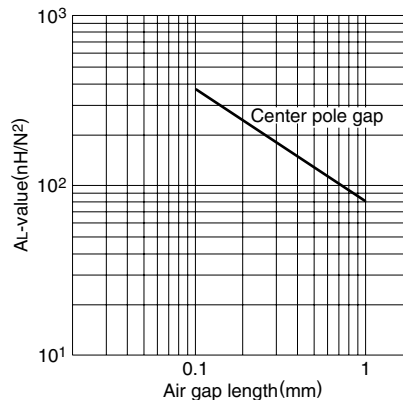

Note: NI limit shows the point where the exciting current is 20% and 40% away from its extended linear part.

Measuring conditions • Coil: ø0.2 2UEW 100Ts
• Frequency: 1kHz
• Level: 0.5mA

Ferrite

For Switching Power Supplies

Technical Data

EPC Series EPC25B Cores

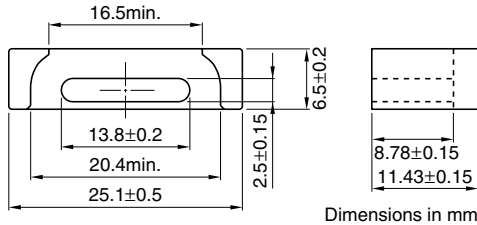

Parameter

Core factor	C1	mm ⁻¹	1.39
Effective magnetic path length	ℓ _e	mm	46.2
Effective cross-sectional area	A _e	mm ²	33.3
Effective core volume	V _e	mm ³	1540
Cross-sectional center pole area	A _{cp}	mm ²	32.4
Minimum cross-sectional area	A _{cp min.}	mm ²	30.3
Cross-sectional winding area of core	A _{cw}	mm ²	62.1
Weight (approx.)		g	11

Part No.	AL-value (nH/N ²)	Core loss (W) at 100°C		Calculated output power (forward converter mode)
		100kHz, 200mT	500kHz, 50mT	
PC44EPC25B-Z	1560±25% (1kHz, 0.5mA)*	0.65 max.		45W (100kHz)
PC50EPC25B-Z	1080±25% (1kHz, 0.5mA)*	0.22 max.		87W (500kHz)

* Coil: ø0.23 2UEW 100Ts

NI limit vs. AL-value for PC44EPC25B gapped core (Typical)

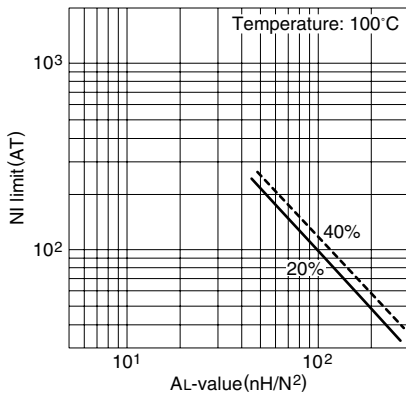

AL-value vs. Air gap length for PC44EPC25B core (Typical)

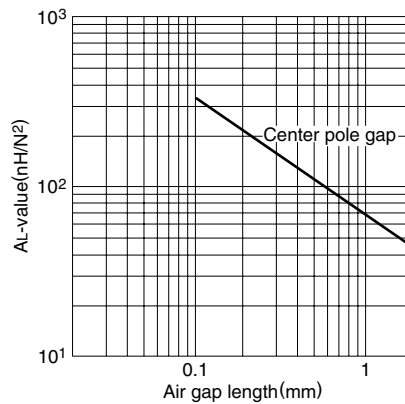

Temperature rise vs. Total loss for EPC25B core (Typical) (Ambient temperature: 25°C)

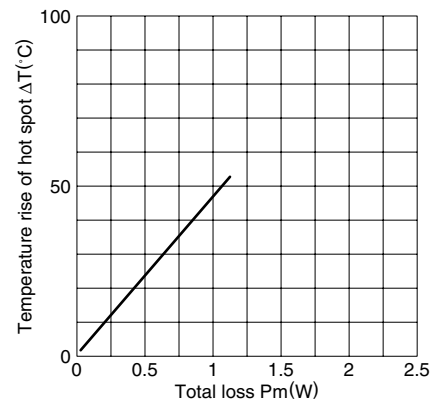

Note: The temperature rise is measured in the room whose temperature and humidity are fixed to 25°C and 45(%RH), respectively. (approx. 400×300×300cm)

NI limit vs. AL-value for PC50EPC25B gapped core (Typical)

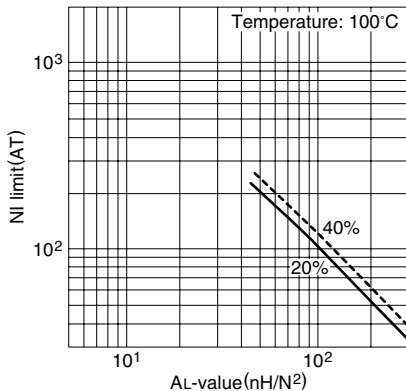

AL-value vs. Air gap length for PC50EPC25B core (Typical)

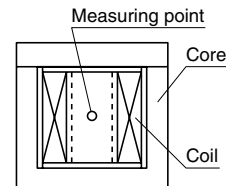
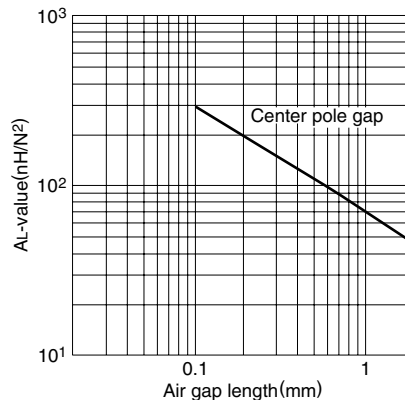

Note: NI limit shows the point where the exciting current is 20% and 40% away from its extended linear part.

Measuring conditions • Coil: ø0.23 2UEW 100Ts
• Frequency: 1kHz
• Level: 0.5mA

Ferrite

For Switching Power Supplies

Technical Data

EPC Series EPC27 Cores

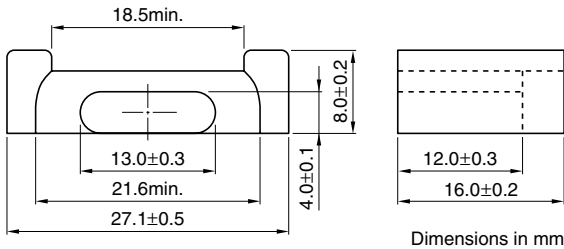

Parameter

Core factor	C1	mm ⁻¹	1.34
Effective magnetic path length	ℓ _e	mm	73.1
Effective cross-sectional area	A _e	mm ²	54.6
Effective core volume	V _e	mm ³	4000
Cross-sectional center pole area	A _{cp}	mm ²	48.6
Minimum cross-sectional area	A _{cp min.}	mm ²	46.5
Cross-sectional winding area of core	A _{cw}	mm ²	108
Weight (approx.)		g	18

Part No.	AL-value (nH/N ²)	Core loss (W) at 100°C		Calculated output power (forward converter mode)
		100kHz, 200mT	500kHz, 50mT	
PC44EPC27-Z	1540±25% (1kHz, 0.5mA)*	1.56 max.		80W (100kHz)
PC50EPC27-Z	1030±25% (1kHz, 0.5mA)*	0.46 max.		161W (500kHz)

* Coil: ø0.3 2UEW 100Ts

NI limit vs. AL-value for PC44EPC27 gapped core (Typical)

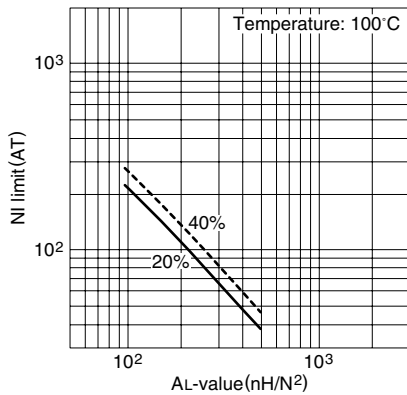

AL-value vs. Air gap length for PC44EPC27 core (Typical)

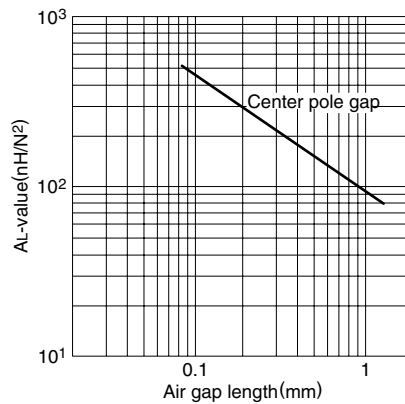

Temperature rise vs. Total loss for EPC27 core (Typical) (Ambient temperature: 25°C)

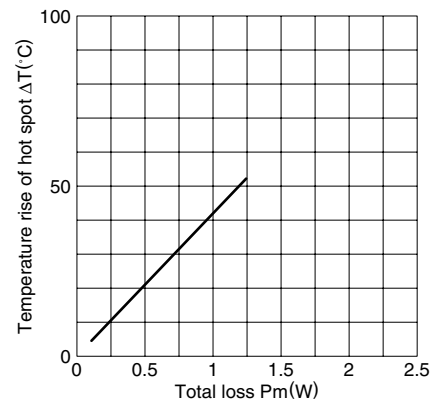

Note: The temperature rise is measured in the room whose temperature and humidity are fixed to 25°C and 45%RH, respectively. (approx. 400×300×300cm)

NI limit vs. AL-value for PC50EPC27 gapped core (Typical)

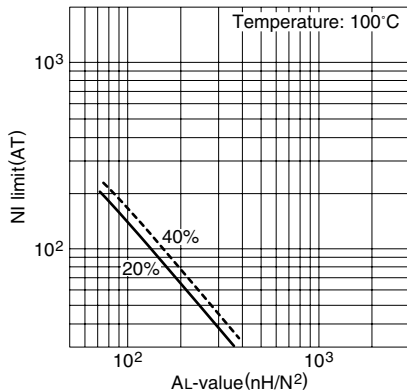

AL-value vs. Air gap length for PC50EPC27 core (Typical)

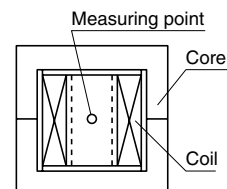
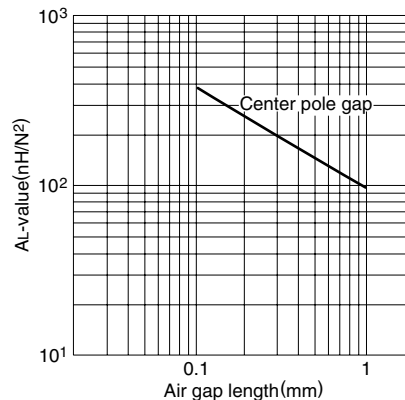

Note: NI limit shows the point where the exciting current is 20% and 40% away from its extended linear part.

Measuring conditions • Coil: ø0.3 2UEW 100Ts
• Frequency: 1kHz
• Level: 0.5mA

Ferrite

For Switching Power Supplies

Technical Data

EPC Series EPC27N Cores

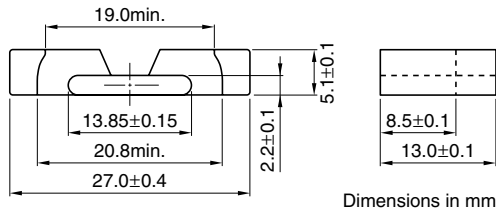

Parameter

Core factor	C1	mm ⁻¹	1.70
Effective magnetic path length	ℓ_e	mm	55.9
Effective cross-sectional area	A_e	mm ²	33.0
Effective core volume	V_e	mm ³	1840
Cross-sectional center pole area	A_{cp}	mm ²	29.7
Minimum cross-sectional center pole area	$A_{cp \text{ min.}}$	mm ²	29.7
Cross-sectional winding area of core	A_{cw}	mm ²	60.4
Weight (approx.)		g	10

Part No.	AL-value (nH/N ²)	Core loss (W) at 100°C 100kHz, 200mT	Calculated output power (forward converter mode)
PC44EPC27N-Z	1400±25% (1kHz, 0.5mA)*	0.73 max.	43W (100kHz)

* Coil: $\phi 0.3$ 2UEW 100Ts

NI limit vs. AL-value for PC44EPC27N gapped core (Typical)

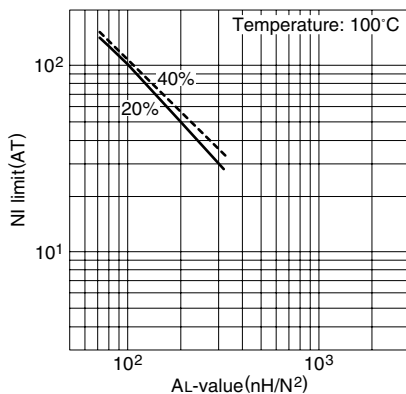

Note: NI limit shows the point where the exciting current is 20% and 40% away from its extended linear part.

AL-value vs. Air gap length for PC44EPC27N core (Typical)

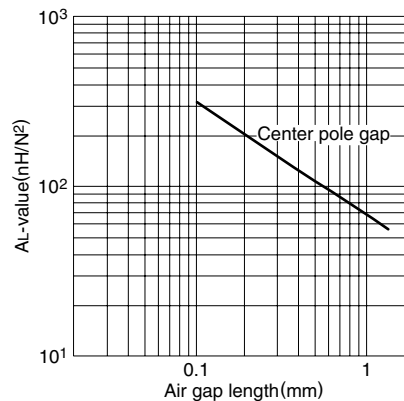

Measuring conditions • Coil: $\phi 0.3$ 2UEW 100Ts
• Frequency: 1kHz
• Level: 0.5mA

Temperature rise vs. Total loss for EPC27N core (Typical) (Ambient temperature: 25°C)

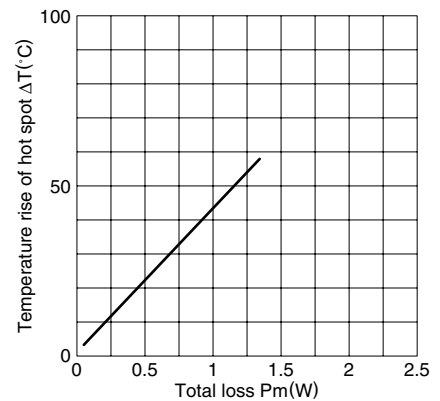

Note: The temperature rise is measured in the room whose temperature and humidity are fixed to 25°C and 45%RH, respectively. (approx. 400×300×300cm)

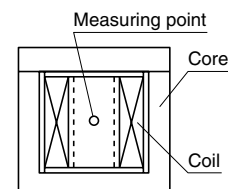

Ferrite

For Switching Power Supplies

Technical Data

EPC Series EPC30 Cores

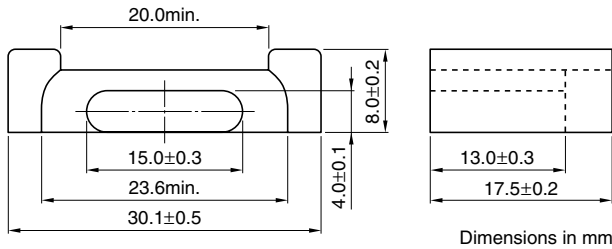

Parameter

Core factor	C1	mm ⁻¹	1.34
Effective magnetic path length	ℓ _e	mm	81.6
Effective cross-sectional area	A _e	mm ²	61.0
Effective core volume	V _e	mm ³	4980
Cross-sectional center pole area	A _{cp}	mm ²	56.6
Minimum cross-sectional area	A _{cp min.}	mm ²	54.3
Cross-sectional winding area of core	A _{cw}	mm ²	117
Weight (approx.)		g	23

Part No.	AL-value (nH/N ²)	Core loss (W) at 100°C		Calculated output power (forward converter mode)
		100kHz, 200mT	500kHz, 50mT	
PC44EPC30-Z	1570±25% (1kHz, 0.5mA)*	2.03 max.		85W (100kHz)
PC50EPC30-Z	1060±25% (1kHz, 0.5mA)*	0.58 max.		180W (500kHz)

* Coil: ø0.3 2UEW 100Ts

NI limit vs. AL-value for PC44EPC30 gapped core (Typical)

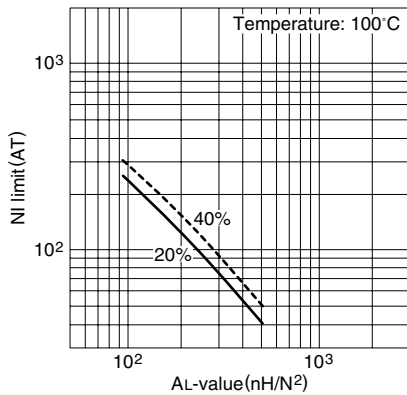

AL-value vs. Air gap length for PC44EPC30 core (Typical)

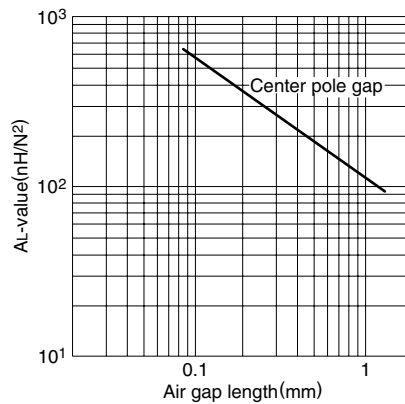

Temperature rise vs. Total loss for EPC30 core (Typical) (Ambient temperature: 25°C)

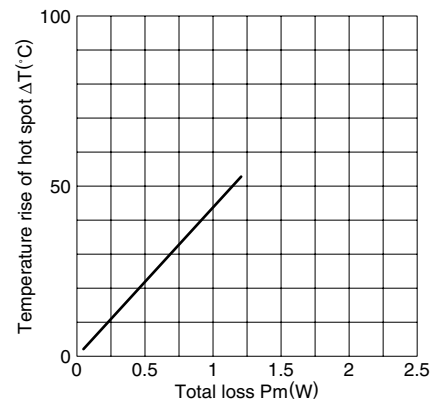

Note: The temperature rise is measured in the room whose temperature and humidity are fixed to 25°C and 45%RH, respectively. (approx. 400×300×300cm)

NI limit vs. AL-value for PC50EPC30 gapped core (Typical)

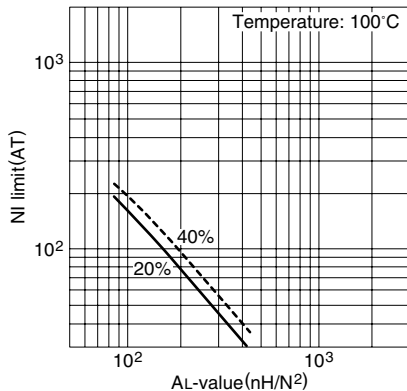

AL-value vs. Air gap length for PC50EPC30 core (Typical)

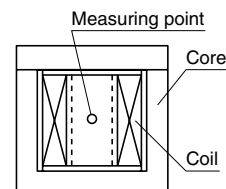
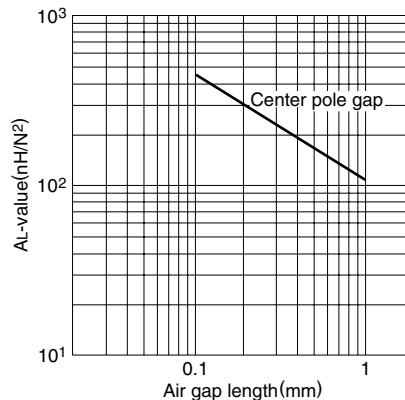

Note: NI limit shows the point where the exciting current is 20% and 40% away from its extended linear part.

Measuring conditions • Coil: ø0.3 2UEW 100Ts
• Frequency: 1kHz
• Level: 0.5mA

Ferrite

For Switching Power Supplies

Maximum Number of Turns on Bobbins

EI and EE Series

EER Series

EC and ETD Series

PQ Series

LP Series

EP Series

RM Series

SMD Series

EPC and EEM Series

Wire Table

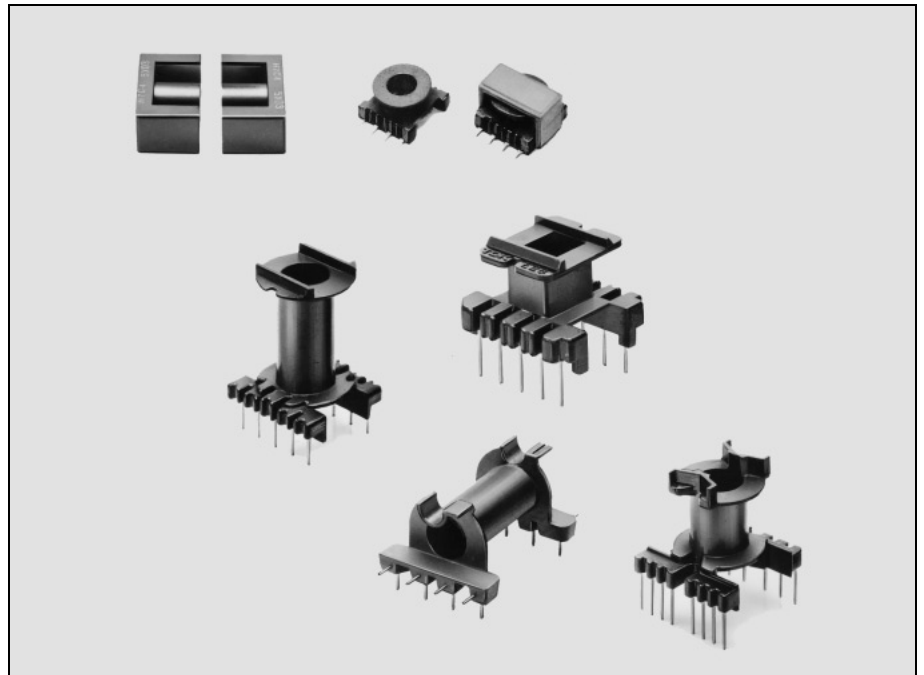

Ferrite

For Switching Power Supplies

Maximum Number of Turns on Bobbins

Maximum Number of Turns on Bobbins EI and EE Series (without terminal pin)

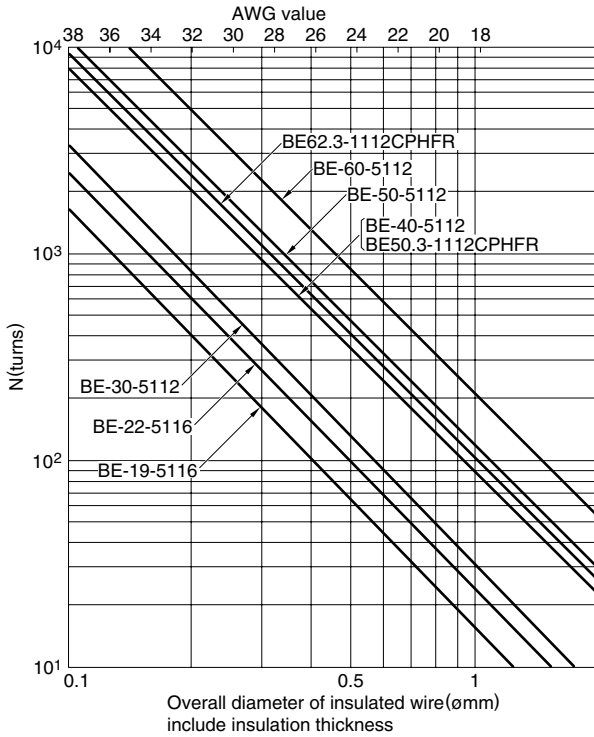

EER Series

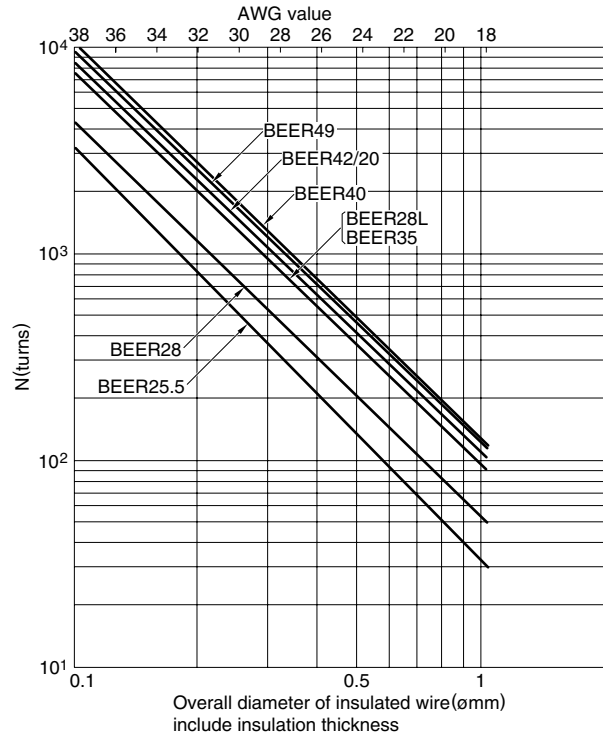

EI and EE Series (with terminal pin)

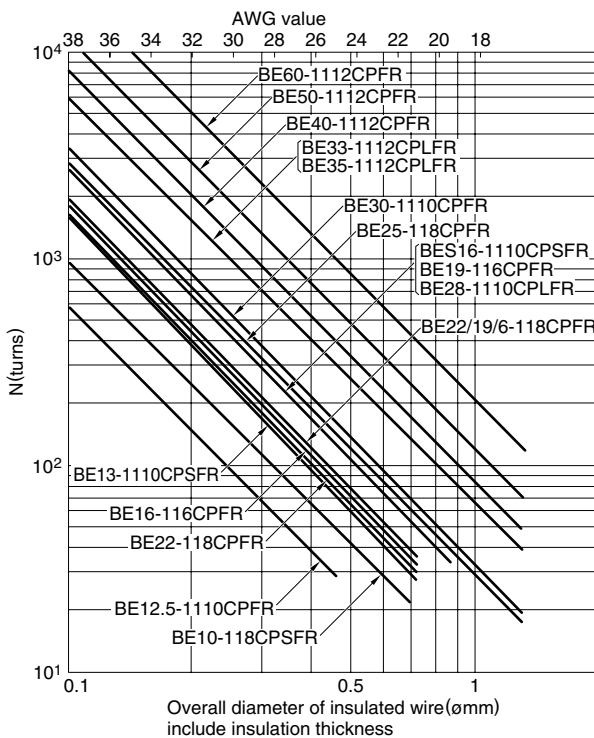

EC and ETD Series

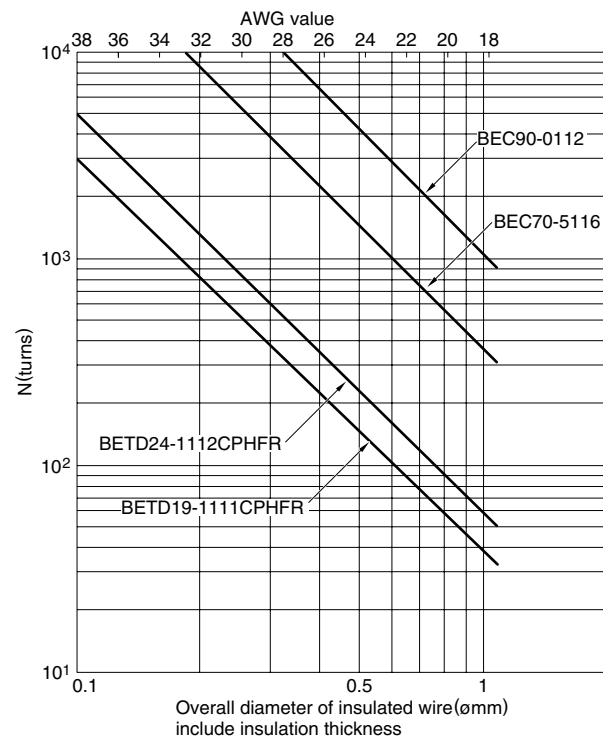

• All specifications are subject to change without notice.

Ferrite

For Switching Power Supplies

Maximum Number of Turns on Bobbins

PQ Series

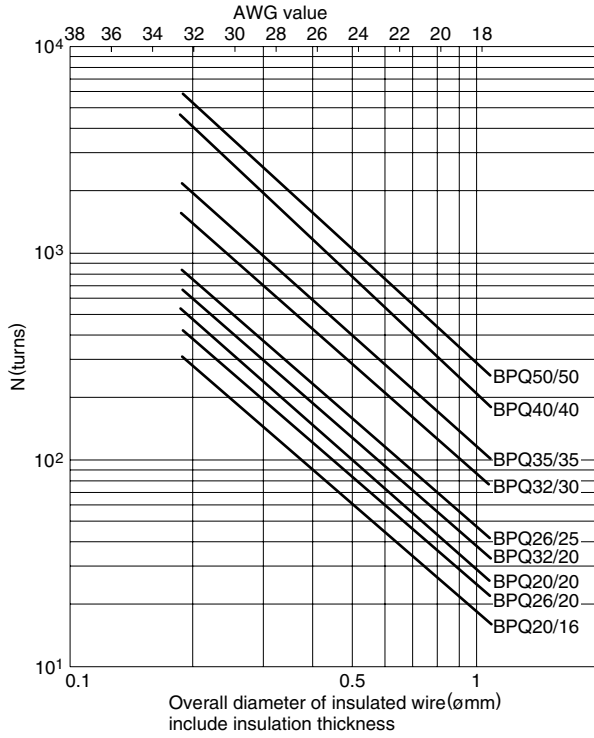

EP Series

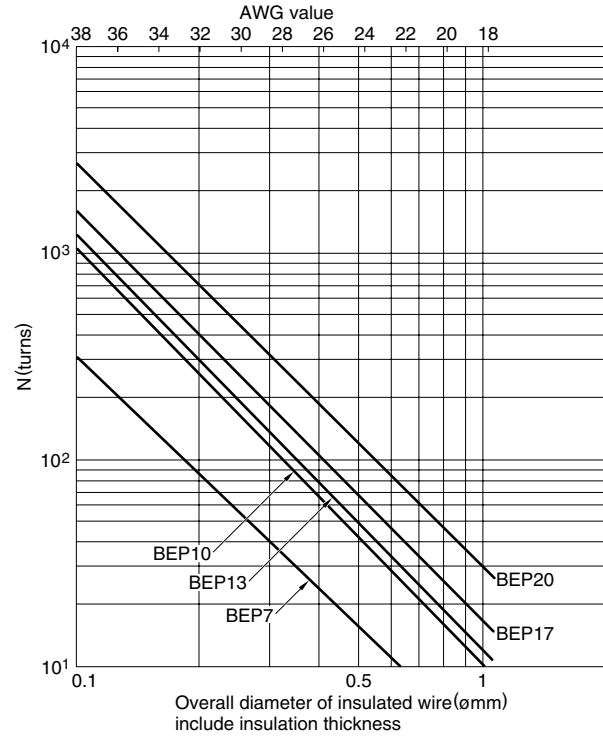

LP Series

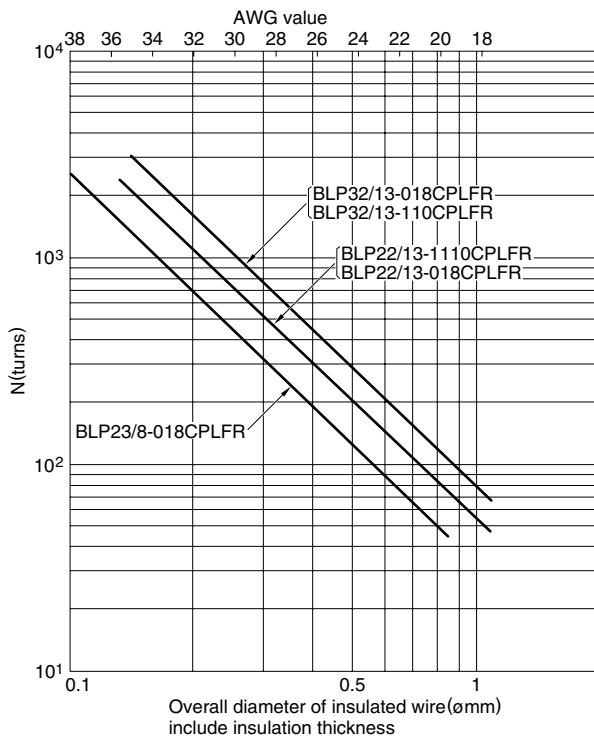

RM Series

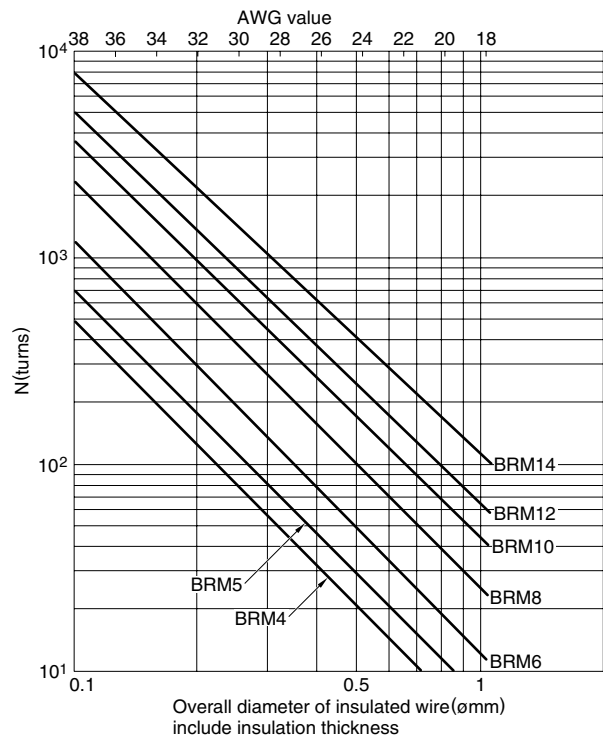

Ferrite

For Switching Power Supplies Maximum Number of Turns on Bobbins

SMD Series

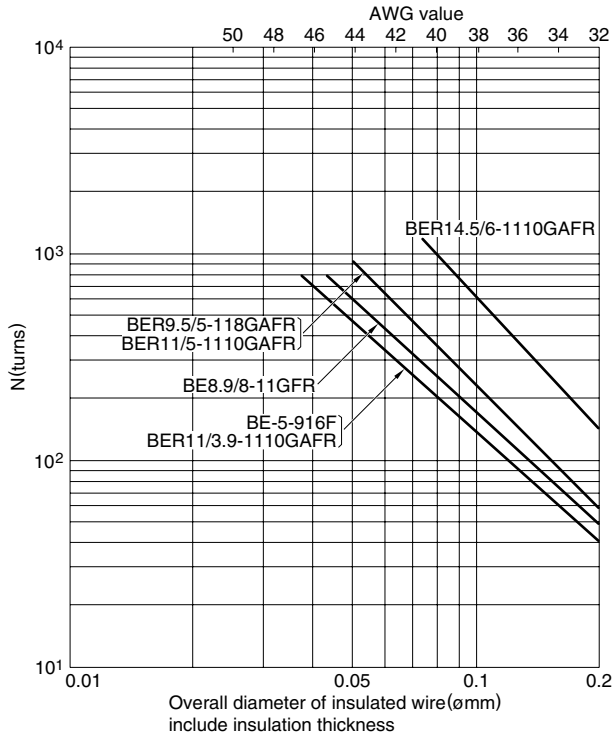

EPC and EEM Series

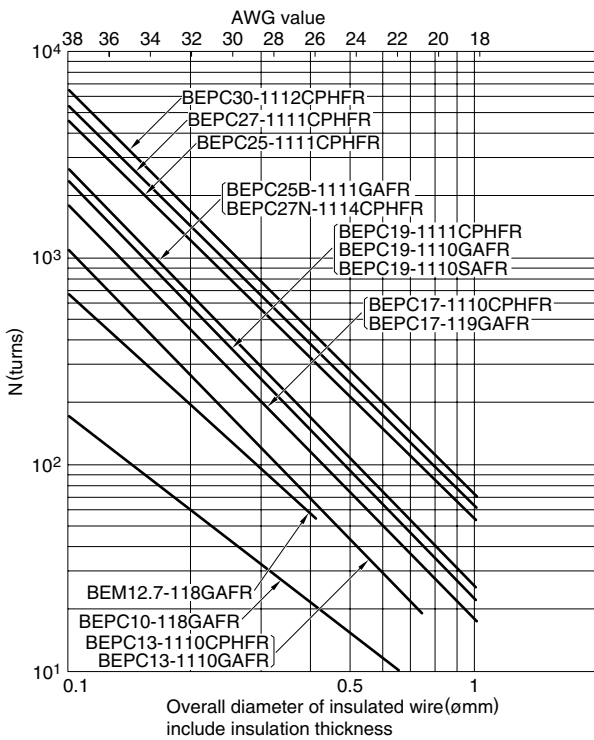

• All specifications are subject to change without notice.

Ferrite

For Switching Power Supplies

Wire Table of Bobbins

Wire Table

AWG	AWG dia.(mm)	AWG area(mm ²)	Single dia.(mm)	Single area(mm ²)	Heavy dia.(mm)	Heavy area(mm ²)
40	0.078	0.0053	0.093	0.0068	0.100	0.0078
39	0.089	0.0066	0.104	0.0085	0.112	0.0099
38	0.102	0.0083	0.117	0.0108	0.126	0.0125
37	0.114	0.0105	0.131	0.0135	0.141	0.0156
36	0.127	0.0132	0.147	0.0169	0.158	0.0195
35	0.142	0.0166	0.164	0.0212	0.176	0.0243
34	0.160	0.0209	0.184	0.0265	0.196	0.0303
33	0.180	0.0264	0.205	0.0330	0.219	0.0376
32	0.203	0.0332	0.229	0.0412	0.244	0.0467
31	0.226	0.0418	0.256	0.0513	0.271	0.0578
30	0.254	0.0526	0.285	0.0640	0.302	0.0717
29	0.287	0.0663	0.319	0.0797	0.336	0.0888
28	0.320	0.0834	0.356	0.0993	0.374	0.1099
27	0.360	0.1050	0.397	0.1237	0.416	0.1362
26	0.404	0.1322	0.443	0.1542	0.464	0.1688
25	0.454	0.1664	0.495	0.1922	0.516	0.2093
24	0.510	0.2095	0.552	0.2397	0.575	0.2596
23	0.574	0.2638	0.617	0.2990	0.641	0.3222
22	0.642	0.3321	0.689	0.3731	0.714	0.4001
21	0.724	0.4181	0.770	0.4659	0.796	0.4972
20	0.812	0.5624	0.861	0.5820	0.887	0.6183
19	0.910	0.6627	0.962	0.7272	0.990	0.7693
18	1.024	0.8343	1.076	0.9092	1.104	0.9578
17	1.156	1.0504	1.203	1.1371	1.233	1.1933
16	1.298	1.3224	1.346	1.4228	1.376	1.4877
15	1.456	1.6648	1.506	1.7809	1.537	1.8559
14	1.634	2.0959	1.685	2.2301	1.717	2.3165
13	1.833	2.6386	1.886	2.7935	1.919	2.8931
12	2.057	3.3219	2.111	3.5006	2.145	3.6153
11	2.308	4.1821	2.364	4.3882	2.399	4.5201
10	2.589	5.2651	2.647	5.5024	2.683	5.6542
9	2.905	6.6285	2.964	6.9018	3.002	7.0763
8	3.260	8.3449	3.320	8.6594	3.359	8.8599
7	3.657	10.5059	3.720	10.8674	3.759	11.0977
6	4.104	13.2264	4.168	13.6419	4.208	13.9062