

檔案名稱	SG384x Product Data Sheet Ver. D.3 (SG3842G/3843G)		制訂部門	IC 研發部
文件編號	IRO33.0007.B2		版本	B2
生效日期	2004/04/12		總頁數	19
文件修訂履歷				
版本	日期	修訂人	修訂頁次	修訂內容概述
B0 VD.1	2003/02/27	汪仁傑	--	1.修改 IC 改版後的相關規格內容。 2.依據 ECN_IR920227-1
B1 VD.2	2003/04/25	汪仁傑		1.修改 IC 的相關規格內容。 2.ECN：IR920428-2
B2 VD.3	2004/04/12	汪仁傑	3	1.增加 Lead Free Part No.;ECN:IR930408-6 2.刪除 SG3844&SG3845 Part No.，以及規範中與 SG3844 和 SG3845 相關的內容。
發 行		核 准		審 查
DCC		林振宇		林振宇
				製 作
				汪仁傑

FEATURES

- 384x series pin-to-pin compatible
- Linearly decreasing PWM frequency
- Burst-mode at low/zero load
- 5uA start-up current
- 5mA operating current
- Vcc over voltage protection
- Cycle-by-cycle current limiting
- Zero cross-conduction
- Slew rate controlled high current totem pole output
- Fast current sense propagation delay
- Under voltage lockout (UVLO) with hysteresis

APPLICATIONS

- Switching mode power supplies
- Power converters

DESCRIPTION

The SG384xG series of current-mode PWM controllers combines high performance with Green-mode power saving features. SG384xG controllers are fully pin-to-pin compatible with bipolar UC384x devices, but they have improved features and functionality. SG384xG series controllers are compatible with the BiCMOS fabrication process, enabling the use of low start-up current and operating currents. This feature further improves power conversion efficiency. The minimal

start-up current has been reduced to 5uA, and the minimum operating current has been reduced to 5mA. Each SG384xG has a slew rate controlled high current totem pole output, ideally suited for driving a power MOSFET while keeping EMI low.

The current-sense propagation delay is typically 50ns, resulting in significantly more effective constant power protection. During normal operation, a SG384xG controller acts as a fixed frequency PWM controller. The PWM frequency can be easily programmed by changing external R_T and C_T values. The SG384xG includes two Green-mode functions that dramatically reduce power usage, helping the power supply comply with the latest international power saving guidelines. To cut power consumption under light load conditions, the controller's Green-mode function will linearly decrease the PWM frequency in response to decreases in the output load. Under ultra light-load/zero-load conditions, the RT/CT PWM oscillator periodically shuts down, and enters into Burst-mode. This causes the IC's supply voltage to begin gradually dropping. Just before the supply voltage drops below the UVLO voltage threshold, the RT/CT PWM oscillator turns back on, to prevent the supply voltage from going below the UVLO voltage.

SG384xG controllers also come with Over Voltage Protection (OVP). This shuts down PWM output if the supply voltage ever exceeds 27V. The SG384xG series comes in 8-pin DIP and SOP packages.

TYPICAL APPLICATION

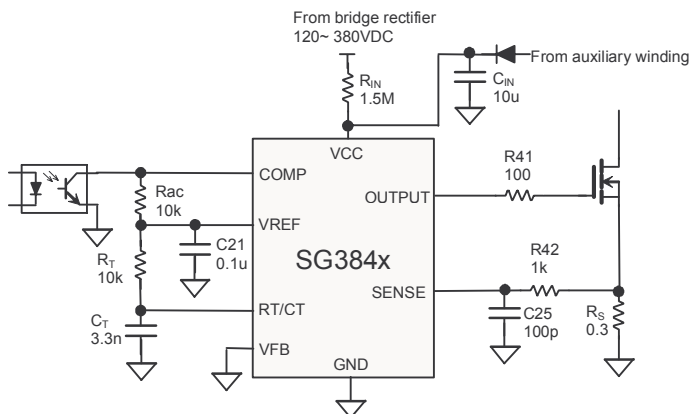

**Green-mode Operation
Oscillator Frequency vs. COMP**

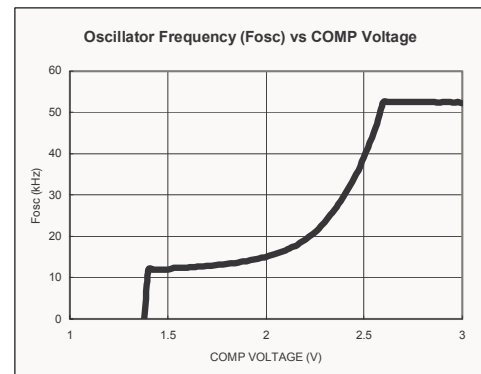

MARKING INFORMATION

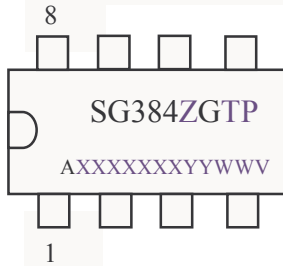

Z: 2, 3
 T: D = DIP, S = SOP
 P : Z = Lead Free
 Null=Regular Package
 XXXXXXX: Wafer Lot
 YY: Year; WW: Week
 V: Assembly Location

PIN CONFIGURATION

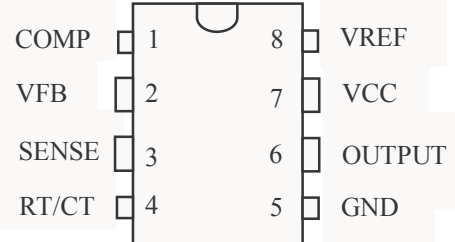

ORDERING INFORMATION

Part Number	UVLO		AV	Package
	Start threshold	Stop threshold		
SG3842GAD	16V±1V	10V±1V	5.0	8-Pin DIP
SG3842GAS				8-Pin SOP
SG3842G2AD			3.0	8-Pin DIP
SG3842G2AS				8-Pin SOP
SG3843GAD	8.9V±0.5V	8.1V±0.5V	3.0	8-Pin DIP
SG3843GAS				8-Pin SOP
SG3842GADZ	16V±1V	10V±1V	5.0	8-Pin DIP(Lead Free)
SG3842GASZ				8-Pin SOP(Lead Free)
SG3842G2ADZ			3.0	8-Pin DIP(Lead Free)
SG3842G2ASZ				8-Pin SOP(Lead Free)
SG3843GADZ	8.9V±0.5V	8.1V±0.5V	3.0	8-Pin DIP(Lead Free)
SG3843GASZ				8-Pin SOP(Lead Free)

PIN DESCRIPTIONS

Pin No.	Symbol	Function	Description
1	COMP	Compensation	Output of the Error Amplifier and input to the PWM comparator. It is used for feedback loop compensation.
2	VFB	Feedback	Inverting input of the Error Amplifier. It is normally connected to the switching power supply output through a resistor divider.
3	SENSE	Current sense	Current sense comparator input. It is internally set to 1V maximum. A voltage proportional to the inductor current is connected to this input.
4	RT/CT	Oscillator control	Oscillator RC timing connection. Connecting a resistor RT from this pin to Vref, and a capacitor CT from this pin to ground, programs the oscillator frequency and the maximum output duty cycle.
5	GND	Ground	This pin is the combined control circuit ground and power ground.
6	OUTPUT	Output	High-power, totem-pole driver output. This output drives the gate of a power MOSFET.
7	VCC	Power supply	Supply voltage input.
8	VREF	Reference voltage	5V-reference voltage output.

OPERATING CONDITIONS

Symbol	Parameter	Min.	Max.	Unit
V _{CC}	Supply voltage	-	20	V
C _T	Oscillation timing capacitor	0.47	10	nF
R _T	Oscillation timing resistor	2.0	100	kΩ
f _{OSC}	Oscillation frequency	10	500	kHz
T _a	Operating ambient temperature	-40	105	°C

ELECTRICAL CHARACTERISTICS

Reference Voltage Section

Symbol	Parameter	Test Condition	Min.	Typ.	Max.	Unit
V _{ref}	Reference output voltage	T _a =25°C, I _o =1mA	4.75	5.0	5.25	V
Line	Line regulation	V _{CC} =10 to 20V	-	2	20	mV
Load	Load current regulation	I _o =1mA to 20mA	-	20	50	mV
V _{TC}	Temperature stability	-	-	0.5	-	mV/°C
I _{OS}	Short-circuit output current	-	-30	-85	-180	mA
V _{ref}	Total output variation	Line, Load, Temperature	4.75	5.0	5.25	V
V _n	Output noise voltage	f=10Hz to 10kHz, T _a =25°C	-	50	-	μV
S	Long term stability	T _a =125°C for 1000 hours	-	5	25	mV

Oscillator Section (V_{FB}=0V, SENSE=0V)

Symbol	Parameter	Test Condition	Min.	Typ.	Max.	Unit
F _{OSC}	Oscillator frequency	SG3842G, SG3843G, SG3842G2	49	52	55	kHz
F _{OSC-G}	Green-mode frequency (note 1)	V _{sense} =0V	8	12	16	kHz
V _{COMP,H}	Comp Voltage that initiates Green-mode	SG3842G SG3842G2, SG3843G	-	2.60 2.00	-	V
V _{COMP,L}	Comp Voltage that shuts down PWM	SG3842G SG3842G2, SG3843G	-	1.40 1.30	-	V
fdv	Frequency change with V _{CC}	V _{CC} =10 to 20V	-	0.2	1	%
fdt	Frequency change with temp.	T _a =-40 to 85°C	-	0.02	-	%/°C
I _{DISCHG}	Discharge current	T _a =25°C	7	9	12	mA

Note 1: F_{OSC-G} is the last PWM frequency before completely turned off @ V_{CC}=15V

Error Amplifier Section

Symbol	Parameter	Test Condition	Min.	Typ.	Max.	Unit
V _{FB}	Input voltage	Comp=2.5V	2.45	2.5	2.55	V
I _{IB}	Input bias current	-	-	-	0.1	μA
A _{VOL}	Open-loop voltage gain	-	45	55	-	dB
BW	Unity gain bandwidth	-	0.7	1.2	-	MHz
PSRR	Power supply rejection ratio	-	50	-	-	dB
I _{SOURCE}	Output source current	FB=2.3V, COMP=0V	-0.8	-1.8	-3	mA
I _{SINK}	Output sink current	FB=2.7V, COMP=1V	2	6.5	-	mA
V _{H,COMP}	Output voltage	FB=2.3V, R _L =15K to GND	6	6.6	-	V
V _{L,COMP}	Output voltage	FB=2.7V, R _L =15K to V _{REF}	-	-	700	mV

Current Sense Section

Symbol	Parameter	Test Condition	Min.	Typ.	Max.	Unit
AV	Current sense input voltage gain (n)	SG3842G	4.60	5.00	5.40	V/V

BiCMOS Green-Mode PWM Controllers
SG3842G/ SG3843G

		SG3842G2,SG3843G	2.76	3.00	3.24	V/V
I_{IB}	Input bias current	-	-	-1	-5	uA
T_{PD}	Delay to output	Ta=25°C	-	50	150	nS
$V_{TH(S)}$	Maximum input signal	-	0.9	1.0	1.1	V

Output Section

Symbol	Parameter	Test Condition	Min.	Typ.	Max.	Unit
V_{ol}	Output voltage low	Vcc=15V, Io=20mA	-	-	0.5	V
V_{oh}	Output voltage high	Vcc=15V, Io=20mA	13	-	-	V
T_r	Rising time	Ta=25°C, CL=1nF	-	50	150	nS
T_f	Falling time	Ta=25°C, CL=1nF	-	50	150	nS

Under-Voltage Lockout Section

Symbol	Parameter	Test Condition	Min.	Typ.	Max.	Unit
$V_{TH(ON)}$	Start threshold voltage	SG3842G	15	16	17	V
		SG3843G	8.4	8.9	9.4	V
$V_{TH(OFF)}$	Minimum operating voltage	SG3842G	9	10	11	V
		SG3843G	7.6	8.1	8.6	V

PWM Section

Symbol	Parameter	Test Condition	Min.	Typ.	Max.	Unit
$DCY_{(MAX)}$	Maximum duty cycle	SG3842G, SG3842G2, SG3843G	90	95	98	%
$DCY_{(MIN)}$	Minimum duty cycle	FB=5V, COMP=Open	-	-	0	%

Total Standby Current Section

Symbol	Parameter	Test Condition	Min.	Typ.	Max.	Unit
$I_{CC ST}$	Start-up current	SG3842G, Vcc=15V	-	5	15	uA
		SG3843G, Vcc=8V	-	3	10	uA
$I_{CC OP}$	Operating supply current	FB=SENSE=0V, VDD=15V, CL=1000pF	-	5.0	6.5	mA
V_Z	Power supply zener voltage	Icc=10mA	25	28	-	V
V_P	Power supply protection voltage			27		V

TYPICAL CHARACTERISTICS

SG3842G

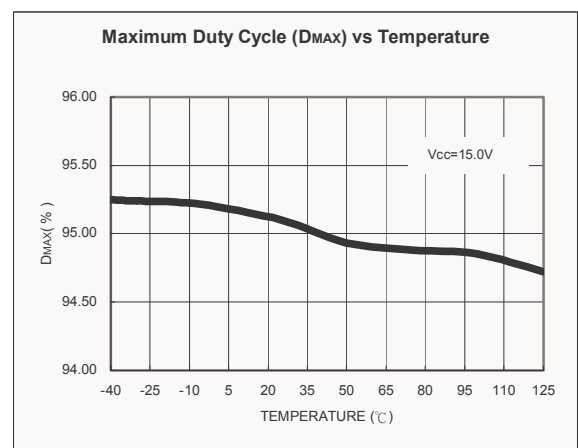
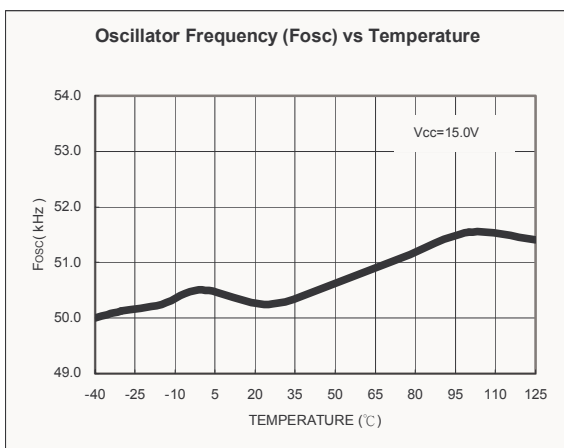
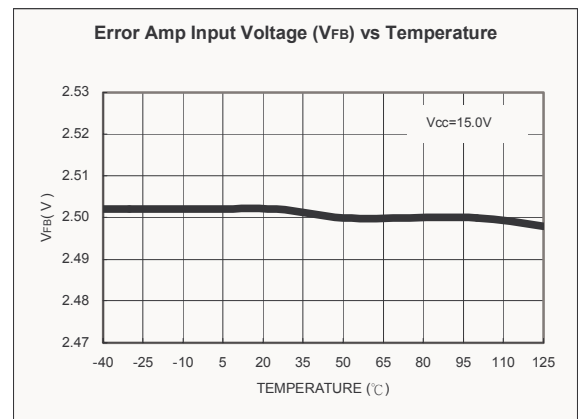
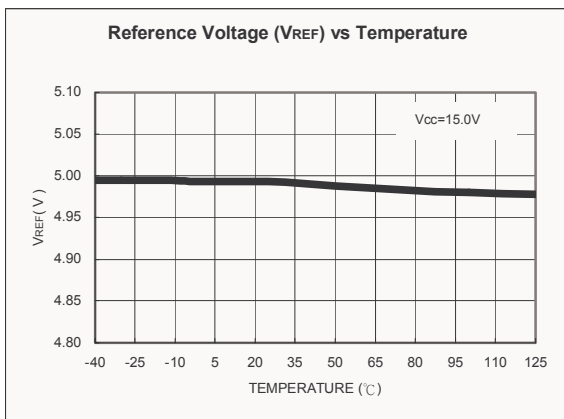
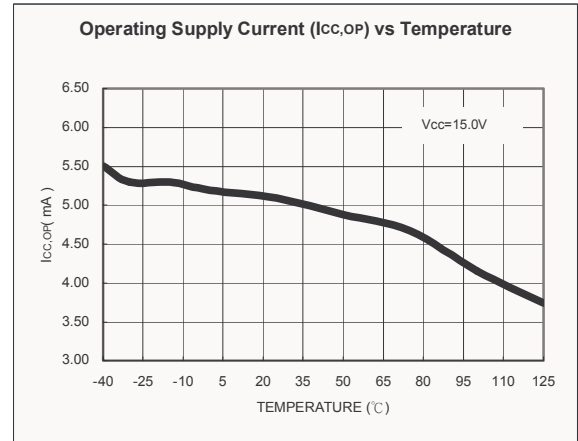
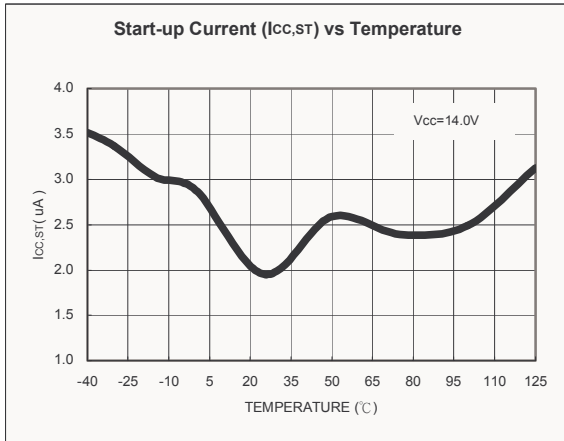

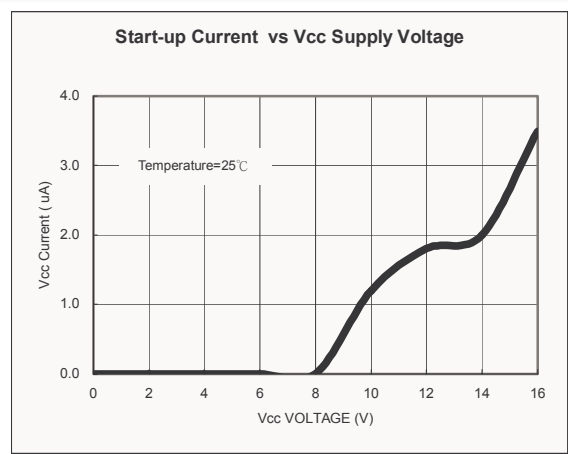
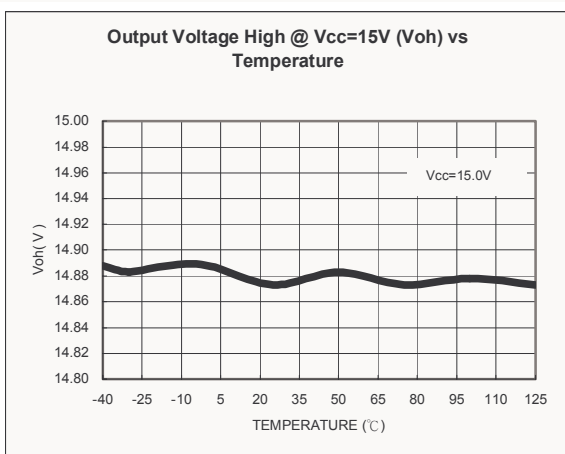
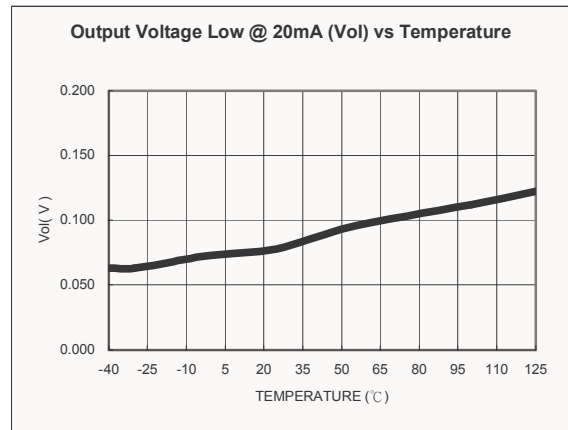
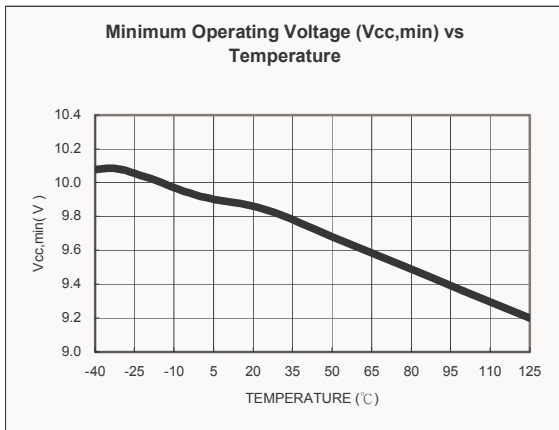
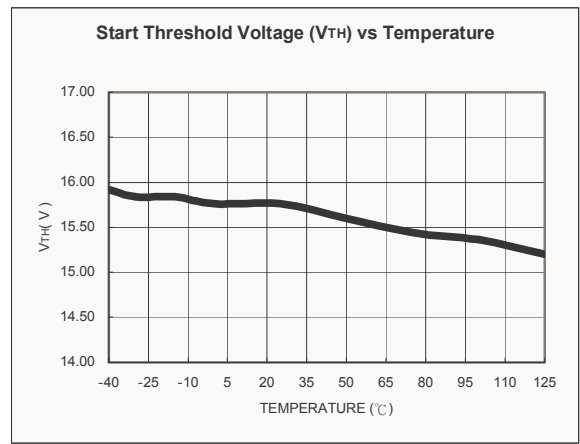
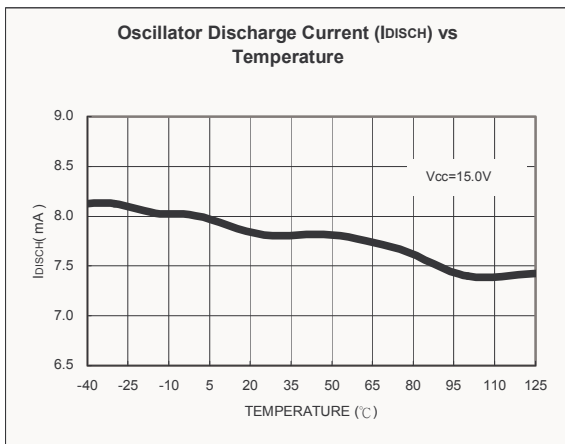

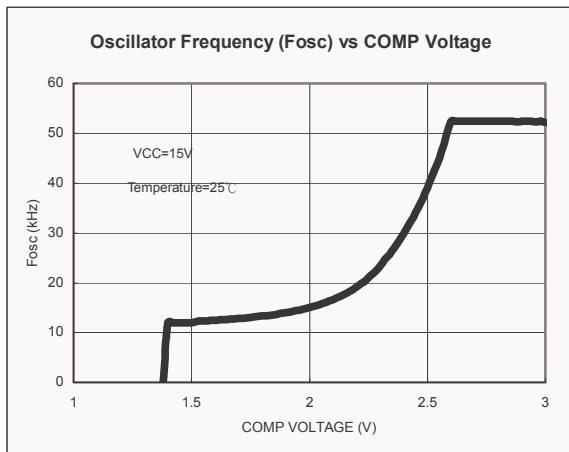
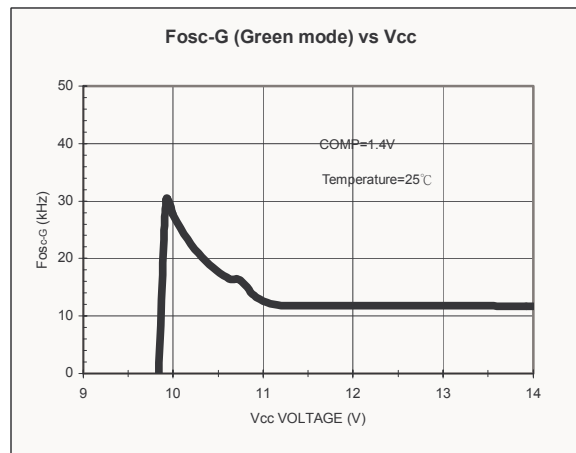
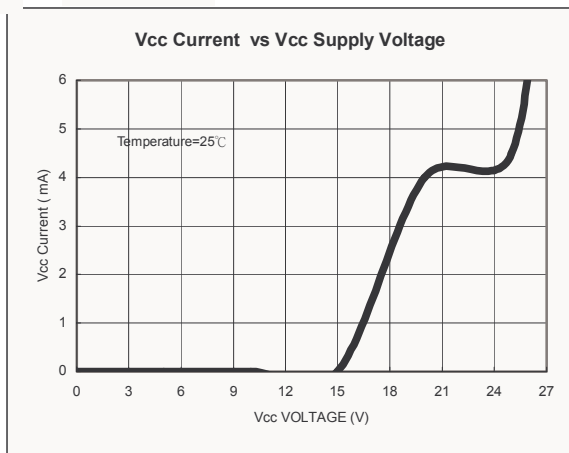

SG3843G

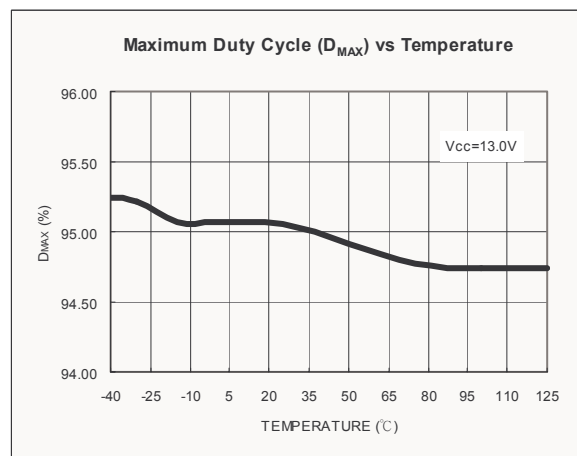
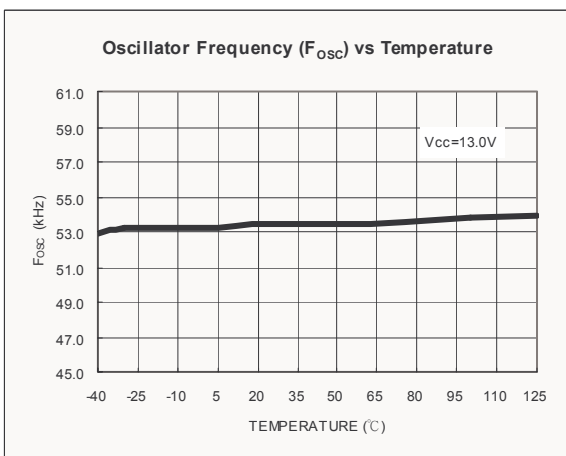
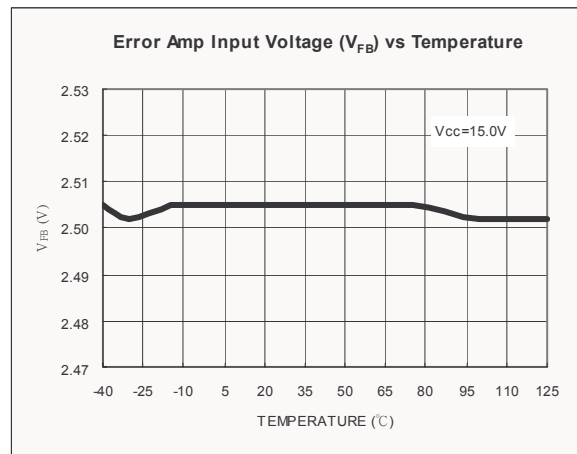
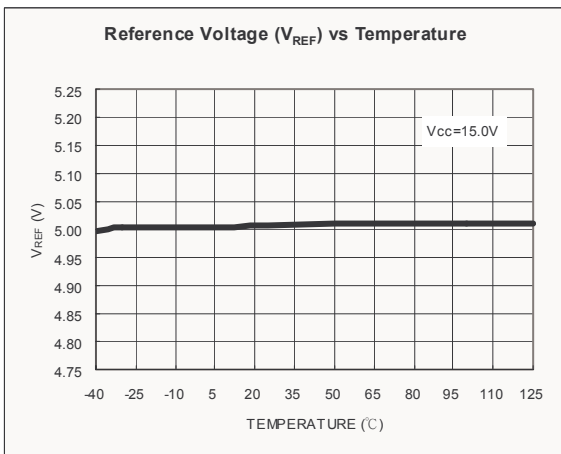
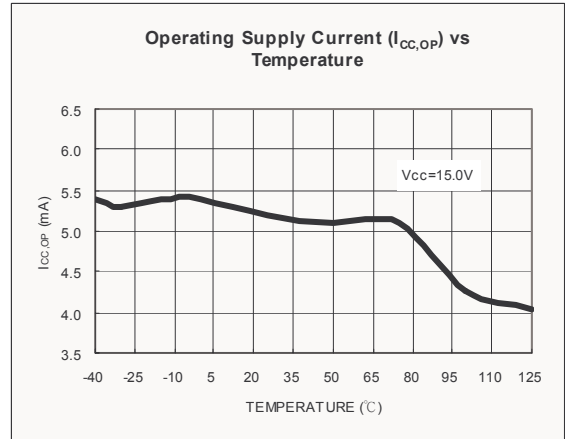
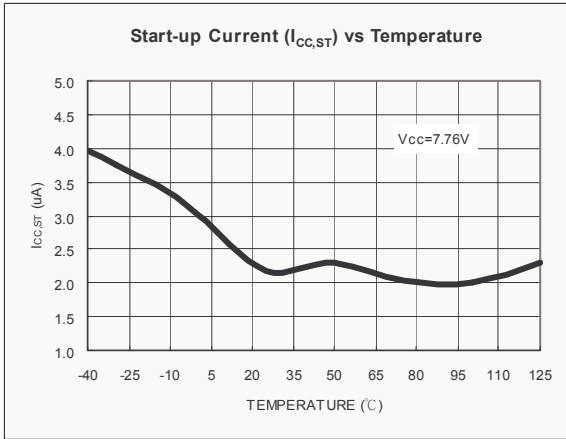

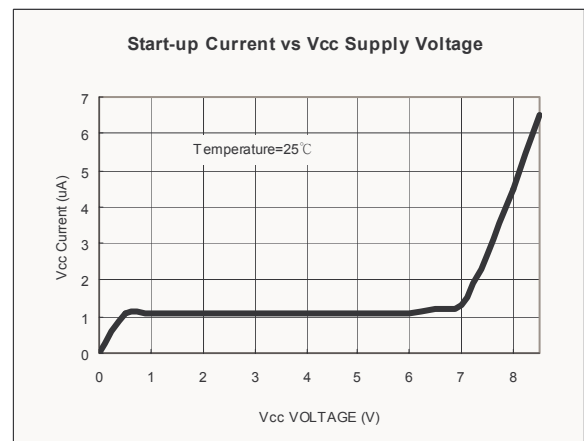
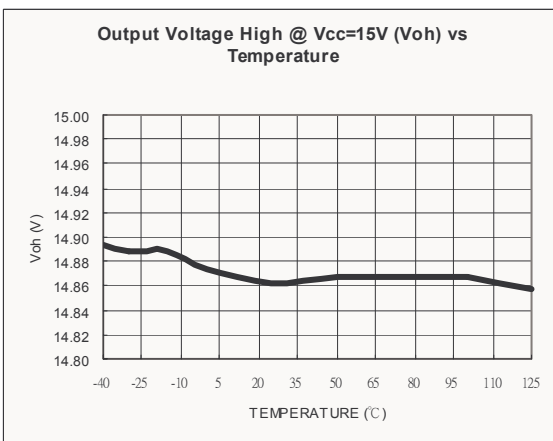
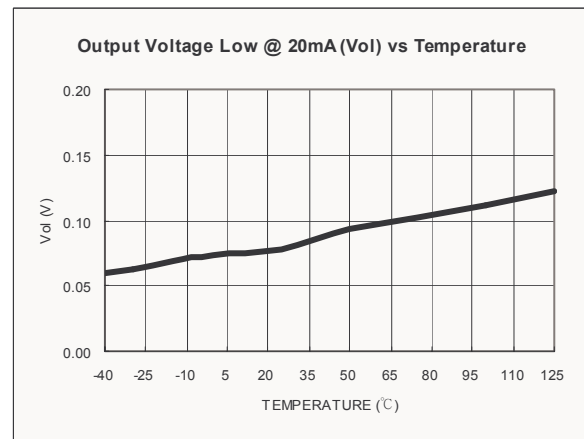
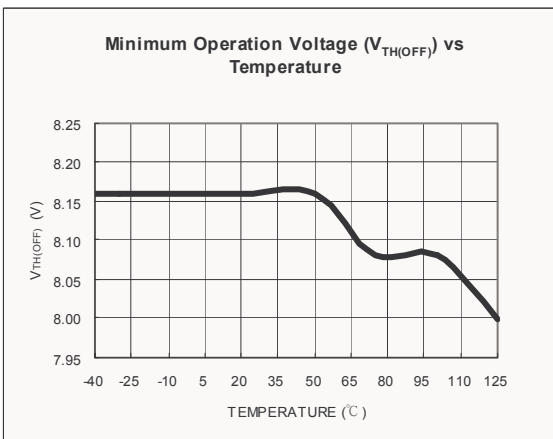
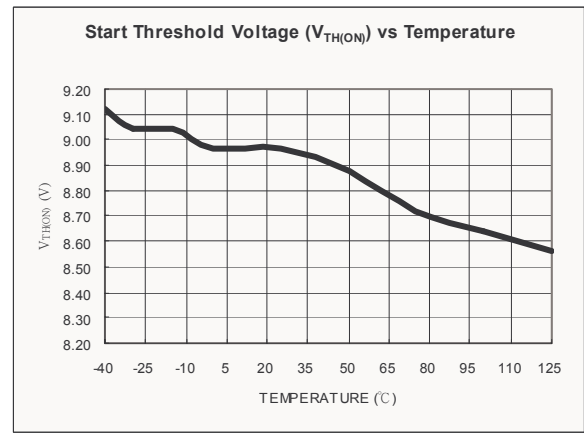
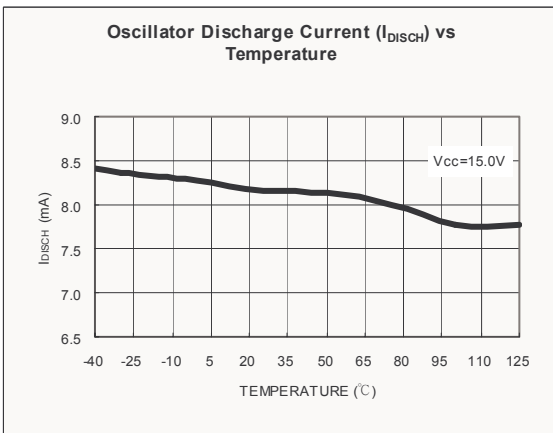

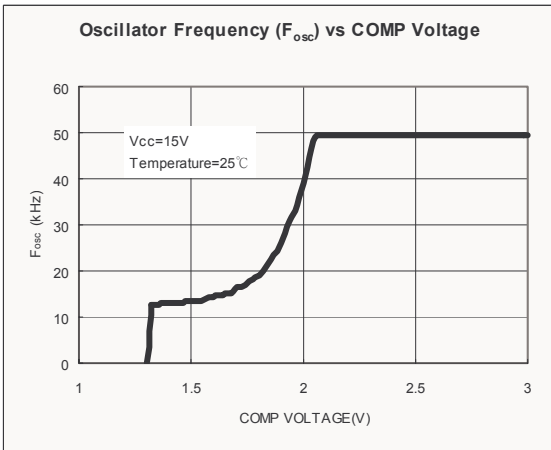
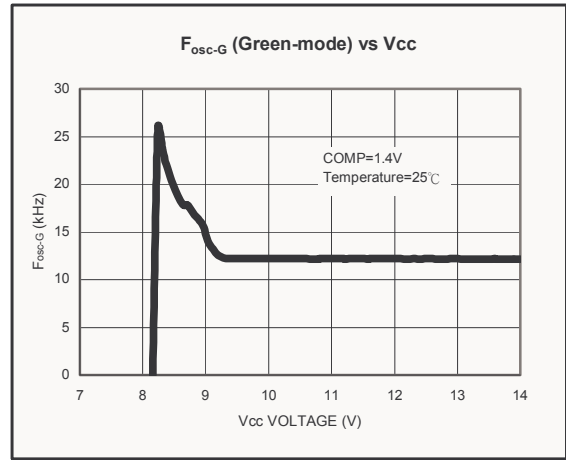
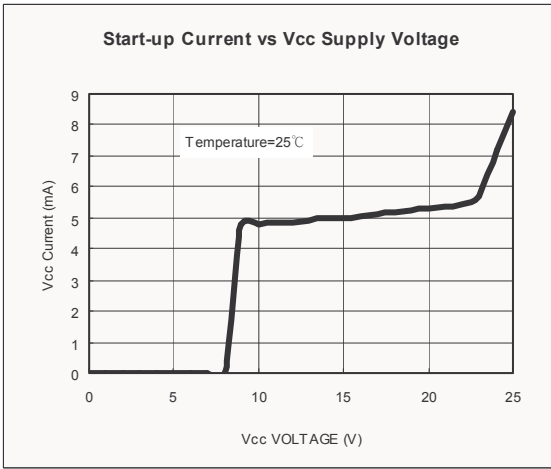

OPERATION DESCRIPTION

SG384xG devices have many advantages over traditional 384x devices and are completely pin-to-pin compatible with them. The following descriptions highlight the advantages and the differences of the SG384xGA designs.

Start-up Current

The required start-up current is typically only 5uA. This ultra-low start-up current allows designers to supply the start-up power required by the SG384xG using a high-resistance and a low-wattage start-up resistor. For example, an application using wide input range (100V_{AC}~240V_{AC}) AC-to-DC power adapter could work with a 1.5 MΩ/0.25W resistor, and a 10uF/25V V_{cc} hold-up capacitor.

Operating Current

The operating current has been reduced to 5.0mA. This low operating current results in higher efficiency and reduces the required V_{cc} hold-up capacitance.

Oscillator Operation

The resistor R_T and the capacitor C_T, both connected to the pin RT/CT, determine the oscillation frequency. The capacitor C_T is normally charged to 2.9V through the resistor R_T, which is connected to a 5V reference voltage and discharged to 1.3V by a built-in constant current sink. The dead-time is generated during the discharge period.

$$f(kHz) = \frac{1.72}{[R_T(k\Omega) \times C_T(\mu F)]}$$

Error Amplifier

The error amplifier's inverting input is connected to the FB pin, and the output is connected to the COMP pin. The COMP output is available for external compensation, allowing designers to control the feedback-loop frequency-response. Non-inverting input is not wired out

to a pin, but it is internally biased to a fixed 2.5V ± 2% voltage.

Current Sensing and PWM Limiting

The SG384xG current-sense input is designed for current-mode control. Current-to-voltage conversion is done externally through the current-sense resistor R_s. Under normal operation, the COMP voltage determines the peak-voltage across R_s. V_{COMP} is the voltage at the pin COMP and *n* is the current-sense input voltage gain.

$$I_{pk} = \frac{V_{COMP} - 1.4}{n * R_s}$$

**n* is typically 5 (4.60 ~ 5.40) for the SG3842G standard versions. *n* = 3 typically (2.76 ~ 3.24) for the SG3842G2, and the SG3843G models.

This feature is compatible with general 384x series products. A higher *n* value attenuates the feedback and ensures loop stability under light-load conditions. The inverting input to the SG384xG current-sense comparator is internally clamped to 1V.

Under Voltage Lockout (UVLO)

The Under Voltage Lockout (UVLO) function ensures the SG384xG's supply voltage V_{cc} will be sufficiently high before the output stage is enabled. The turn-on and turn-off threshold voltages are fixed internally at 16V/10V for the SG3842G and at 8.9V/8.1V for the SG3843G. The hysteresis voltage between turn-on and turn-off prevents V_{cc} from being unstable during power on/off sequencing. At start-up, before the output switch is enabled, the V_{cc} hold-up capacitor C_{IN} must be charged up to 16V (SG3842G) through the start-up resistor R_{IN}. The ultra-small start-up current of 5uA allows very large resistance values for the resistor R_{IN} to be used, even with low input voltages. For example, if V_{AC} = 90V_{rms}, R_{IN} can be as large as 1.5 MΩ and still charge the hold-up capacitor C_{IN}. The power dissipation from this larger resistance R_{IN} would then be less than 70mW (0.07W), even under high line conditions (V_{AC} = 240V_{rms}). After

the IC starts-up and begins normal operation, one of the transformer’s auxiliary windings generates the supply voltage Vcc, which supplies the operating current of the SG384xG controller.

Slew Rate Controlled Output Driver

The BiCMOS output stage directly drives the external power MOSFET up to the full supply voltage. The output driver, with a low ON-resistance and high current-driving capability, can easily drive an external capacitive load larger than 1000pF. If operating under recommended conditions, the switching frequency can go up to 500kHz.

The output stage is designed to ensure zero cross-conduction current. This minimizes heat dissipation, increases efficiency, and enhances reliability. The output driver is also slew-rate controlled to minimize EMI.

Green-Mode: Linearly Decreasing Frequency and Burst-Mode

System General’s patented Green-mode function reduces the switching frequency under light-load and zero-load conditions. Modulation of the PWM frequency can reduce power consumption under light-load and zero-load conditions, because the power loss is directly proportional to the switching frequency.

Most of the power loss in a power supply occurs due to the switching loss of the transistor, the core loss of the transformer and inductors, and the power loss of the snubber. These sources of power loss all lose power in proportion to the switching frequency.

The controller uses the output of the error amplifier as a feedback voltage to calculate load conditions. When the feedback voltage goes below the Green-mode threshold voltage, the switching frequency will be reduced. Under normal-load and high-load conditions, the PWM operates as usual, and the frequency modulation feature does not affect its operation.

For example, assuming $R_T = 10k\Omega$ and $R_C = 47k\Omega$, the peak RT/CT voltage would only be:

There are two factors that determine the PWM frequency:

1. The resistor R_T and the capacitor C_T determine the RC charge and discharge times, and therefore, the circuit frequency. They are both connected to the pin RT/CT.
2. Internal comparator threshold voltages. Under normal-load conditions, the internal comparator threshold voltages are fixed at 1.3V ($V_{comp,L}$) and 2.9V ($V_{comp,H}$). Under light-load conditions, the $V_{comp,H}$ internal threshold voltage gradually increases. This will increase the RC charging/discharging time, therefore decreasing the frequency. Under ultra-light or zero-load conditions, the $V_{comp,H}$ voltage is increased to 4.6V. This will put the circuit into the

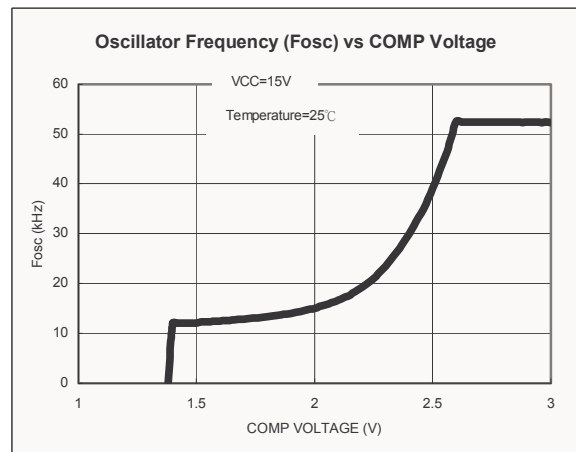

lowest frequency it can operate at. Assuming $R_T = 10k$ and $C_T = 3.3nF$, this is about 12kHz. The frequency vs. COMP voltage (feedback from the output load) is shown in Fig. 1.

Fig.1 Oscillator Frequency vs. COMP Voltage

If 12kHz is not low enough to meet stand-by power conservation requirements, a shunt resistor R_C can be connected in parallel with the capacitor C_T between RT/CT and GND. This will allow the SG384xG to enter into burst-mode.

$$5V \times \frac{47}{(10 + 47)} = 4.12V$$

Since 4.12V is less than the internal $V_{comp,H}$ 4.6V voltage under light-load conditions, the RT/CT oscillator would take a long time to charge up to 4.6V. In this situation, the RT/CT oscillator will stop oscillating.

When oscillation stops, there is no PWM output. Consequently, the energy required to supply the SG384xG from the auxiliary winding also gets cut off. This causes the supply voltage V_{cc} to start dropping. If the supply voltage V_{cc} drops below the UVLO voltage, it will take the SG384xG several hundred milliseconds to start-up. This delay will cause too much fluctuation to the output voltage. To avoid this, the SG384xG will automatically reduce the internal $V_{comp,H}$ voltage, turning the RT/CT oscillator back on when the V_{cc} supply voltage falls within 1.5V of the UVLO voltage. In Burst-mode, the PWM frequency is burst between 0Hz and the light-load tens of kHz region, not over the full frequency range. Fig.2 shows the Green-mode frequency vs. the supply voltage V_{cc} . The Green-mode frequency is fixed at 12kHz when V_{cc} is above 11V. When V_{cc} is below 11V and approaching UVLO, the PWM frequency is gradually increased. This increases the energy supplied to V_{cc} , and pulls up the V_{cc} supply voltage to prevent it from dropping below UVLO.

These techniques help achieve optimal power savings. The SG384xG can linearly decrease the PWM frequency under light-load conditions, and enter into burst-mode under ultra-light load and zero-load conditions. Linear frequency reduction and burst-mode enable the SG384xG to deliver excellent power savings and load regulation.

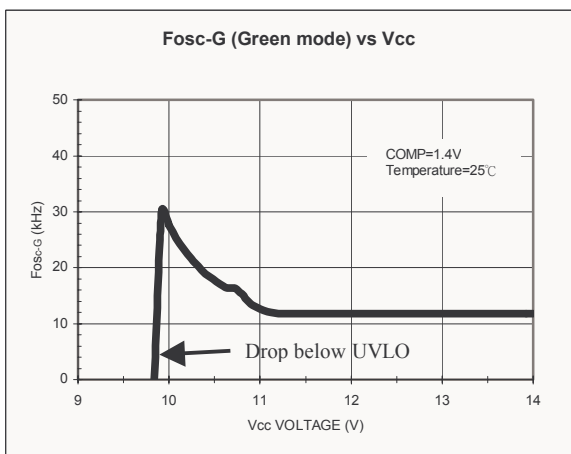

Fig.2 Green-mode Frequency vs. Supply Voltage Vcc

Vcc Over Voltage Protection (OVP)

When the SG384xG's supply voltage increases to 27V due to abnormal conditions, such as an open loop from the photo-coupler, or a short circuit on the output side, the SG384xG will stop PWM output, to protect the entire power supply from being damaged.

Noise Immunity

Noise from the current-sense or the control signal can cause significant pulse-width jitter, particularly under continuous-mode operation. Slope compensation partially alleviates this problem, but the designer should be aware of its presence.

The 384x has a single ground pin. High sink current in the output therefore cannot be returned separately. Ceramic bypass capacitors (0.1uF) from V_{cc} and V_{REF} to ground will provide low-impedance paths for high-frequency transients.

For best results, good high-frequency and RF layout practices should be followed. The designer should avoid long PCB traces and component leads. The oscillator, compensation, and filter components should be located near the 384x. In order to minimize noise interference to the oscillator, it is recommended that C_T should never be less than 1000pF.

Noise caused by the output (pin 6) also causes problems sometimes. This is because the pin is being pulled below ground at turn-off by the external parasitic. This is particularly true when driving a MOSFET. A resistor series connected from the output (pin 6) to the gate of the MOSFET will prevent such output noise.

REFERENCE CIRCUIT

Universal Input, 12V/5A DC Output

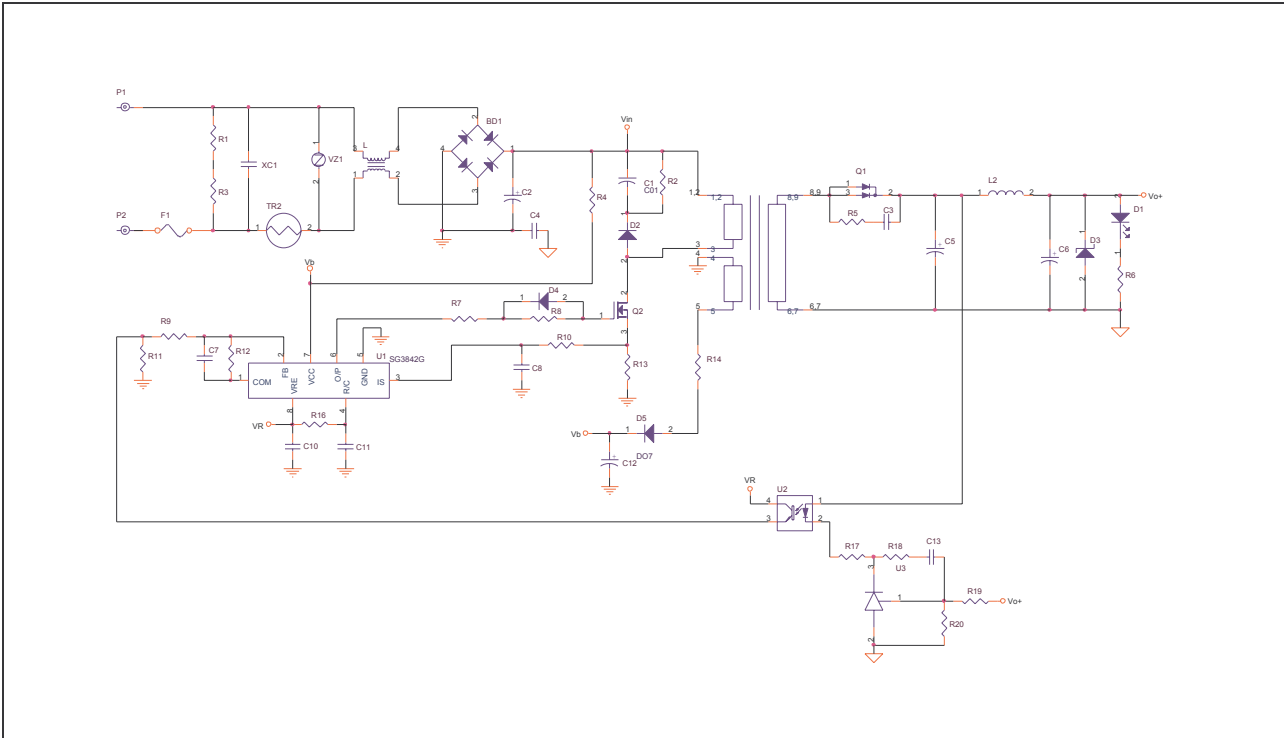

BOM

Symbol	Components	Symbol	Components
BD1	BD 1A/600V	R1,3	470K 1/4W
C1		R2	
C2	EC 68u/400V	R4	1M 1/4W
C3	CC 102P/1KV	R5	43 1/2W
C4	YC 222P	R6	4.7K 1/4W
C5	EC 1200u/16V	R13	0.5 1W
C6	EC 680u/16V	R14	10 1/8W
C12	EC 10u/25V	R17	100 1/8W
D1	LED	TR2	SCK054
D2		T1	EI28
D3	ZD 15V	U1	SG384xG
D4	1N4148	U2	4N35D
F1	2A/250V	U3	TL431
L1	UU10.5	VZ1	VZ
L2		XC1	XC 0.22u
Q2	MOS 2A/600V		

PACKAGE INFORMATION

8 DIP Outline Dimensions

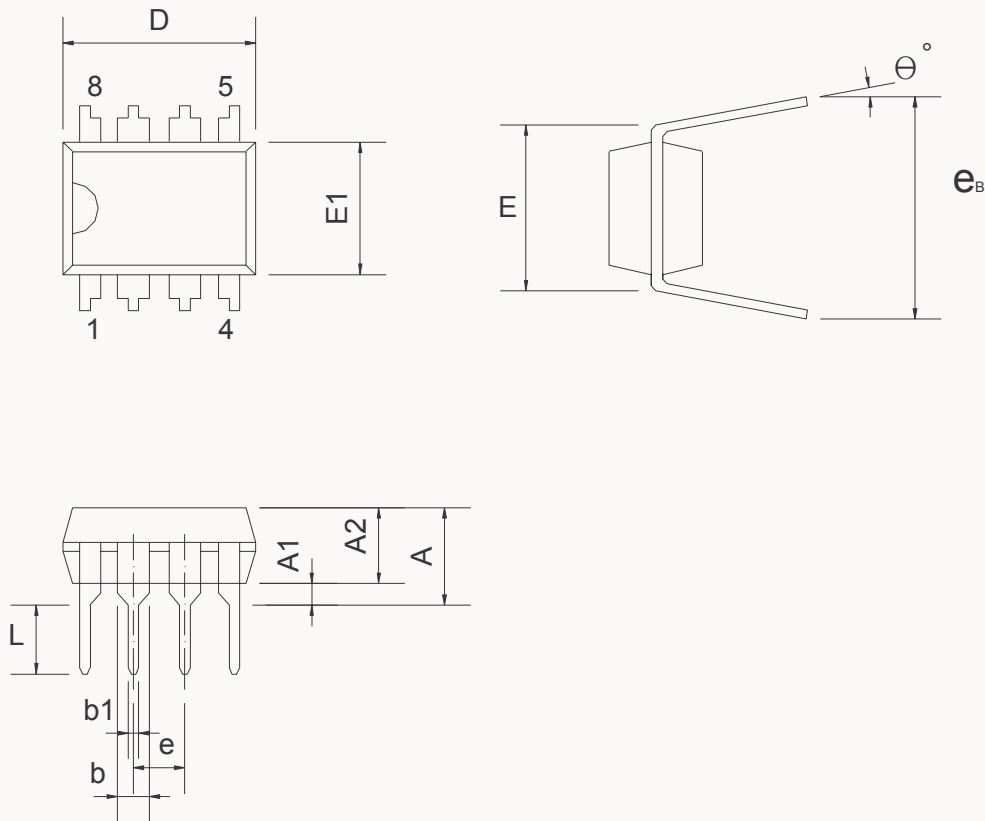

Dimensions

Symbol	Millimeter			Inch		
	Min.	Typ.	Max.	Min.	Typ.	Max.
A			5.334			0.210
A1	0.381			0.015		
A2	3.175	3.302	3.429	0.125	0.130	0.135
b		1.524			0.060	
b1		0.457			0.018	
D	9.017	9.271	10.160	0.355	0.365	0.400
E		7.620			0.300	
E1	6.223	6.350	6.477	0.245	0.250	0.255
e		2.540			0.100	
L	2.921	3.302	3.810	0.115	0.130	0.150
e_B	8.509	9.017	9.525	0.335	0.355	0.375
θ°	0°	7°	15°	0°	7°	15°

8 SOP Outline Dimensions

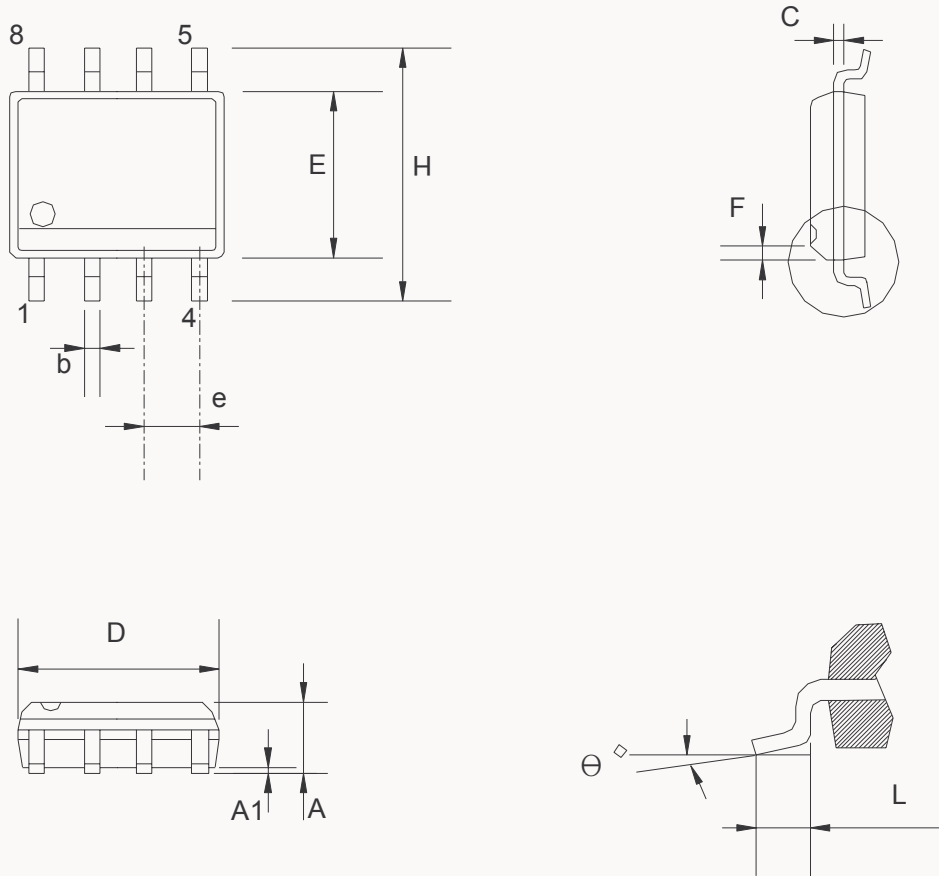

Dimensions

Symbol	Millimeter			Inch		
	Min.	Typ.	Max.	Min.	Typ.	Max.
A	1.346		1.752	0.053		0.069
A1	0.101		0.254	0.004		0.010
b		0.406			0.016	
c		0.203			0.008	
D	4.648		4.978	0.183		0.196
E	0.381		3.987	0.150		0.157
e		1.270			0.050	
F		0.381X45°			0.015X45°	
H	5.791		6.197	0.228		0.244
L	0.406		1.270	0.016		0.050
θ	0°		8°	0°		8°

DISCLAIMERS

LIFE SUPPORT

System General's products are not designed to be used as components in devices intended to support or sustain human life. Use of System General's products in components intended for surgical implant into the body, or in other applications in which failure of the System General's products could create a situation where personal death or injury may occur, is not authorized without the express written approval of System General's Chief Executive Officer. System General will not be held liable for any damages or claims resulting from the use of its products in medical applications.

MILITARY

System General's products are not designed for use in military applications. Use of System General's products in military applications is not authorized without the express written approval of System General's Chief Executive Officer. System General will not be held liable for any damages or claims resulting from the use of its products in military applications.

RIGHT TO MAKE CHANGES

System General reserves the right to change this document and/or this product without notice. Customers are advised to consult their System General sales representative before ordering.