



US005636114A

United States Patent [19]

[11] Patent Number: **5,636,114**

Bhagwat et al.

[45] Date of Patent: **Jun. 3, 1997**

[54] **LOSSLESS SNUBBER CIRCUIT FOR USE IN POWER CONVERTERS**

[75] Inventors: **Pradeep M. Bhagwat**, Baltimore, Md.; **Aduri R. Prasad**, Fords; **Chadd D. Justo**, Jersey City, both of N.J.

[73] Assignee: **Electronic Measurements, Inc.**, Neptune, N.J.

[21] Appl. No.: **565,553**

[22] Filed: **Nov. 30, 1995**

[51] Int. Cl.⁶ **H02M 7/06**

[52] U.S. Cl. **363/56**

[58] Field of Search **363/79-82, 89, 363/222-225, 226, 55-56**

[56] **References Cited**

U.S. PATENT DOCUMENTS

5,045,991	9/1991	Dhyanchand et al.	363/89
5,097,196	3/1992	Schoneman	323/222
5,134,355	7/1992	Hastings	323/211
5,134,356	7/1992	El-Sharkawi et al.	323/211
5,146,398	9/1992	Vila-Masot et al.	363/89
5,146,399	9/1992	Gucyski	363/89
5,177,677	1/1993	Nakata et al.	363/89
5,179,293	1/1993	Hilton	307/255
5,198,972	3/1993	Lafuze	363/138
5,224,025	6/1993	Divan et al.	363/116

5,233,509	8/1993	Ghotbi	363/89
5,235,504	8/1993	Sood	363/53
5,289,046	2/1994	Gregorich et al.	307/66
5,293,111	3/1994	Weinberg	323/222
5,301,095	4/1994	Teramoto et al.	363/21

OTHER PUBLICATIONS

J. Bazinet et al., "Analysis and Design of a Zero Voltage Transition Power Factor Correction Circuit", 1994 *IEEE*, pp. 591-597.

Primary Examiner—Aditya Krishnan
Attorney, Agent, or Firm—Michaelson & Wallace; John C. Pokotylo; Peter L. Michaelson

[57] **ABSTRACT**

A switching power converter employing a novel lossless zero-voltage-switching passive snubber network having a power range of up to 5 KW is presented. The passive snubber network improves efficiency, power density, and transient performance, reduces switching losses and EMI, and permits fixed frequency operation of the switching power converter. The passive snubber network also reduces and/or eliminates large peak currents and reverse recovery current spikes normally seen in conventional switching power converters. The proposed passive snubber network may be used in various switching power converter topologies such as boost, buck, balanced, and flyback power converters.

22 Claims, 11 Drawing Sheets

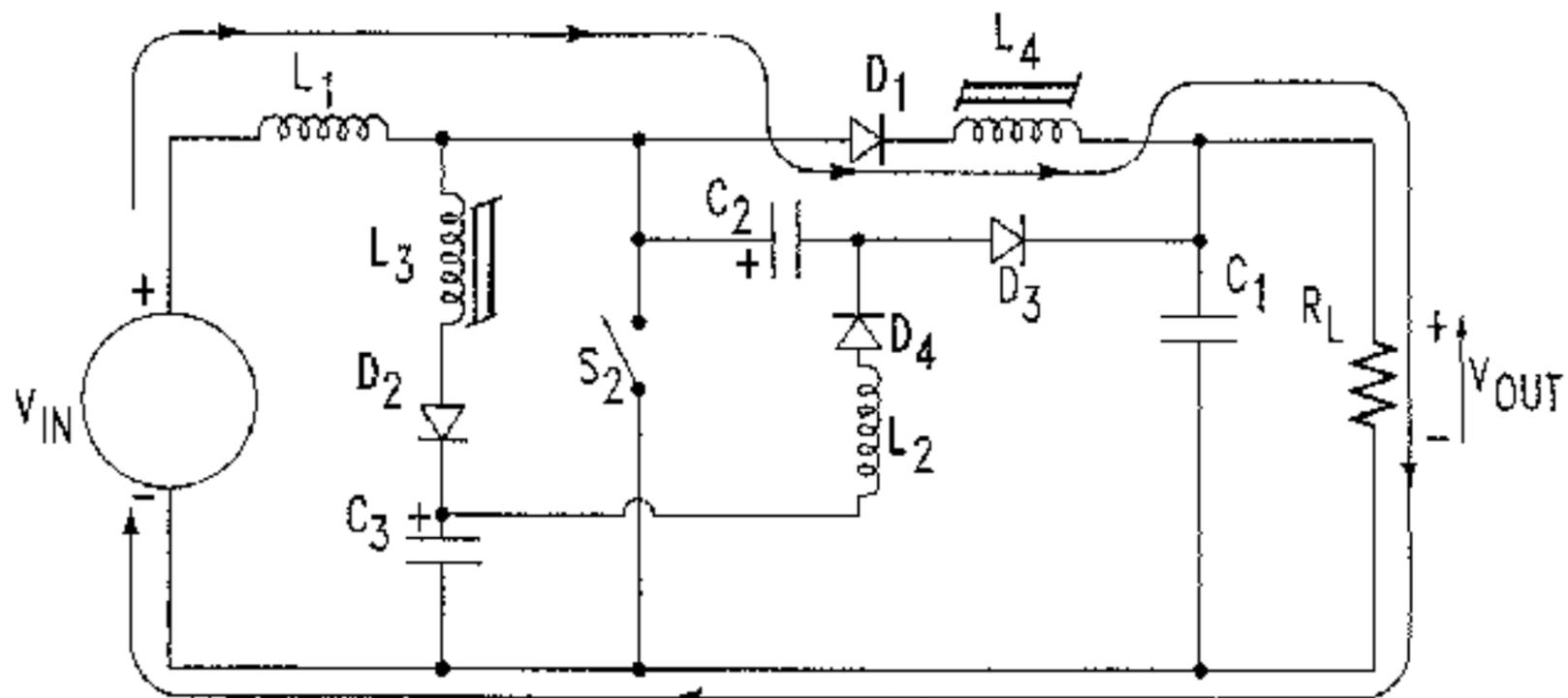

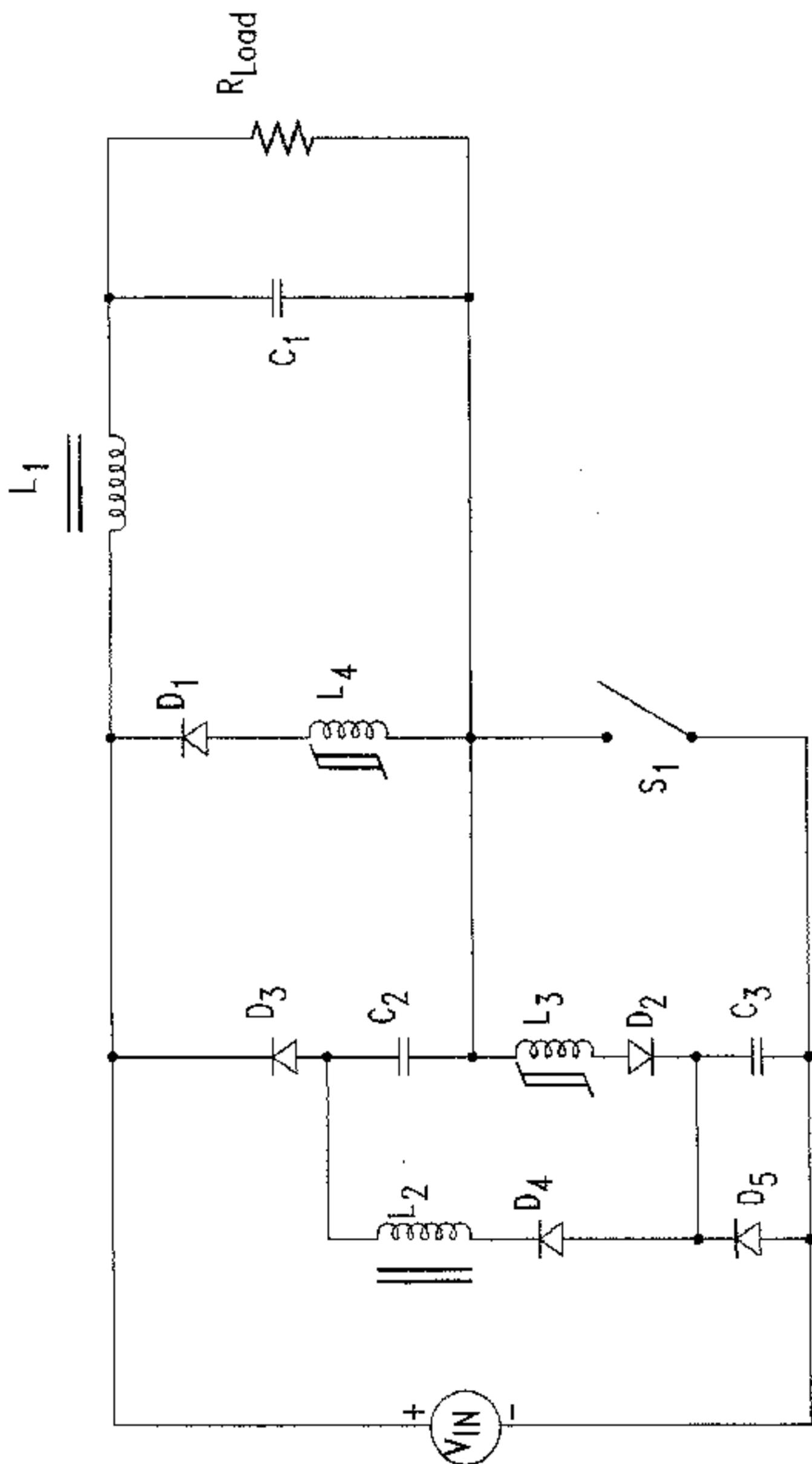

FIG. 10

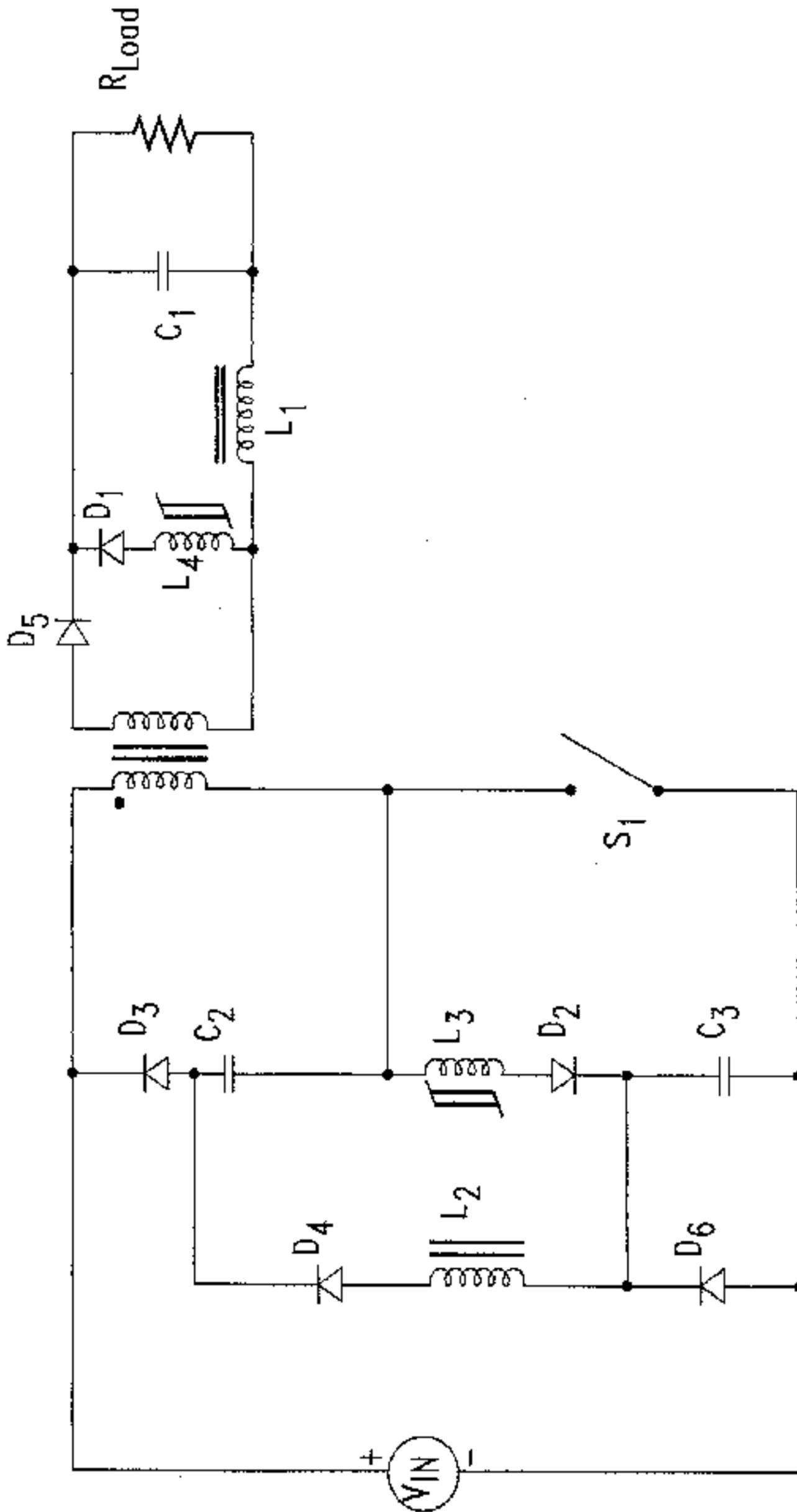

FIG. 11

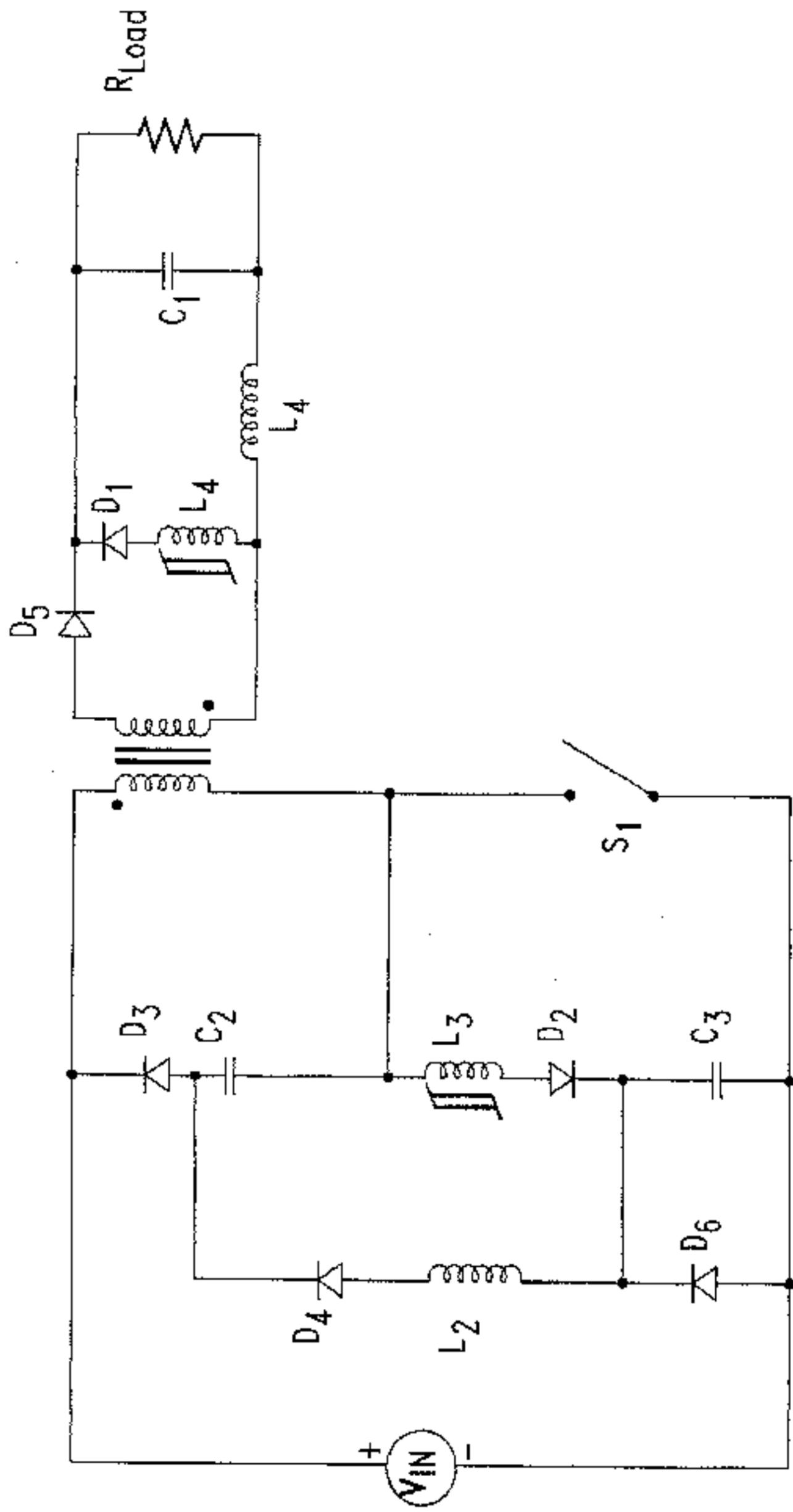

FIG. 12

LOSSLESS SNUBBER CIRCUIT FOR USE IN POWER CONVERTERS

BACKGROUND OF THE INVENTION

a) Field of the Invention

The present invention concerns DC to DC and single phase fed AC to DC switching power converters, and in particular, concerns switching power converters, having an output power of up to 5 KW (Kilo Watts), employing a novel lossless zero-voltage-switching (ZVS) passive snubber network. The proposed passive snubber network improves efficiency, power density, and transient performance, reduces switching losses and electro-magnetic interference (EMI), and permits fixed frequency operation of switching power converters. The proposed passive snubber network also reduces and/or eliminates large peak currents and reverse recovery current spikes which normally occur in known switching power converters. The proposed passive snubber network may be used in various switching power converter topologies such as boost, buck, forward, and flyback power converters.

b) Prior Art

In the past, power conversion, such as DC to DC power conversion for example, was typically performed by hard switched, pulse width modulating (PWM) circuits such as the "boost" power converter shown in FIG. 1, for example. This known power converter includes a controllable switch S_1 (such as a transistor (e.g., a MOSFET), for example) which can be provided with a fixed frequency switching signal from a controller. By varying the duty cycle of the switching signal, the output current of the power converter is controlled. This is known as pulse width modulation (or PWM) control.

Specifically, the conventional boost power converter of FIG. 1 includes a series connection of an inductor L_1 , a diode D_1 , and a capacitor C_1 coupled with the input voltage V_{IN} . The anode of the diode D_1 is coupled with the inductor L_1 while the cathode of the diode D_1 is coupled with the capacitor C_1 . A load R_L to be supplied with an output voltage is coupled across the capacitor C_1 . A controllable switch S_1 , such as a MOSFET for example, includes a first terminal coupled with a node between the inductor L_1 and the anode of the diode D_1 and a second terminal coupled with a lower potential terminal of the input voltage source V_{IN} .

In the conventional boost converter of FIG. 1, when the controllable switch S_1 is open (i.e., blocking), current flows through the inductor L_1 and the diode D_1 . Since the uncharged capacitor C_1 initially appears as a short circuit (because it will draw current), the current flowing through the inductor L_1 and the diode D_1 will charge the capacitor C_1 . When the controllable switch S_1 is subsequently closed (conducting), current from the input voltage V_{IN} will flow through the inductor L_1 and the controllable switch S_1 to ground (or to the negative terminal of the input voltage supply). Assuming that there are no losses in the inductor L_1 , equaling the volt-seconds across the inductor L_1 to zero, and ignoring the turn-on voltage of the diode D_1 , the output voltage V_{OUT} can be determined from the following relationship:

$$V_{OUT} = V_{IN} \cdot \frac{1}{1-D} \quad (1)$$

where D is the duty cycle of the switching signal. Thus, assuming that a fixed frequency switching signal is provided to the controllable switch S_1 , the higher the duty cycle of the switching signal, the higher the output voltage supplied across the output load R_L .

The simple design of the known boost converter of FIG. 1 is based on an assumption that existing power switches closely approximate ideal switches, i.e., that the transitions from opened (i.e., blocking) to closed (i.e., conducting) and closed to opened occur instantaneously. Unfortunately, this assumption is not particularly accurate. Indeed, this assumption, and the power converter topologies it has spawned, are responsible for serious limitations in the performance of the conventional switching converters because the non-ideal (i.e., non-instantaneous) switching characteristic causes switching power ($P = I_{switch} * V_{switch}$) losses.

Specifically, one of the most important characteristics of a DC to DC power converter is that it has a high power density. To possess a high power density, the controllable switch of the power converter must operate at relatively high frequencies. Thus, conventional pulse width modulation power converters, such as the conventional boost power converter discussed above, are disadvantageous because increasing the switching frequencies to achieve higher power densities will cause an increase in switching losses.

In conventional hard switching PWM converters operating at frequencies below 100 KHz and at power levels up to 5 KW, diode stored charge, diode reverse recovery, and device switching losses are reportedly the biggest problems.

Diode reverse recovery in the conventional hard switching boost power factor converter presents a significant limitation because it generates substantial EMI and limits the power conversion frequency and efficiency, particularly in the 3 to 5 KW power range. Specifically, in the conventional hard switching boost converter of FIG. 1, when the switch S_1 is closed, the current through the switch S_1 increases to the level of the current through the inductor L_1 . At this point, the current through the diode D_1 decreases until the diode D_1 no longer conducts. At this time, any charge stored on the diode D_1 is removed via switch S_1 . As the charge is being removed from the diode D_1 , the current through the switch S_1 continues to rise, often to a value of more than twice the inductor current level. The combination of high peak current, high dI/dt (current rate of change), and high dV/dt (voltage rate of change) when the voltage of the switch S_1 approaches the level of the lower potential terminal of V_{in} (or ground), creates significant unwanted RFI/EMI noise and considerably stresses the switch S_1 .

The problems of conventional hard switching PWM power converters (such as boost, buck, forward, and flyback power converters) are explained in greater detail in the article D. M. Divan, "Soft Switching Converters: A Review," *Soft Switching Converters: Topologies, Design, and Control: Summary of Publications 1986-1990: Wisconsin Electric Machines and Power Electronics Consortium*, pp. 1-51 (1990) (hereinafter referred to as "the Divan article" and incorporated herein by reference).

In response to the problems associated with hard switching PWM power converters described above, designers have proposed the use of reactive snubber networks to divert energy that would be dissipated during switching transitions by "trapping" that energy, thereby permitting "soft-switching" of the controllable switch (i.e., switching when little or no voltage appears across the switch and/or when little or no current is flowing through the switch thereby reducing switching stresses). There are two types of such soft-switching converters: (i) zero current switching (ZCS) converters in which opening (switch-off) and closing (switch-on) of the controllable switch occur with no current in the controllable switch; and (ii) zero voltage switching (ZVS) converters in which opening (switch-off) and closing (switch-on) of the controllable switch occur with no voltage across the switch.

Zero current switching (ZCS) is accomplished generally by employing a purely inductive snubber. Zero voltage switching (ZVS) on the other hand is accomplished by employing a purely capacitive snubber having an anti-parallel diode. With ZVS snubber circuits, closing (switch-on) occurs only when the anti-parallel diode is conducting; opening (switch-off) losses decrease with increasing capacitance. Unfortunately, to cause conduction in the anti-parallel diode before turning on the switch, additional circuitry is required to discharge the capacitor or an external resistor is required to dissipate the energy stored in the capacitor during a turn-on part of the switching cycle. Thus, although the controllable switch can operate at elevated frequencies because switching stresses are reduced, the power losses are merely shifted from the controllable switch to the dissipating resistor. Furthermore, if a snubber circuit is not properly designed, it will present a low impedance to the switch when it is turned on and off (closed and opened) which results in a large current spikes.

To solve the power dissipation problem, designers have developed "lossless" soft switching power converters in which the snubber networks are reset by means of inherent circuit operation. These lossless soft switching power converters "recirculate" the energy stored by the reactive snubbers to accomplish lossless operation. Other "lossless" soft switching power converters have snubber networks which are reset by using additional auxiliary switches in conjunction with reactive elements. Unfortunately, this way of eliminating spikes requires extra power handling components. These additional power handling components add size, weight, and cost to the power conversion system. Moreover, they often severely reduce overall system efficiency since the RMS input current is high.

An example of a known zero voltage switching (ZVS) boost power converter (See e.g., J. Bazinet et al., "Analysis and Design of a Zero Voltage Transition Power Factor Correction Circuit," *IEEE Applied Power Electronics Conference (APEC)*, pp. 591-597 (1994)) is illustrated in FIG. 2. As shown in FIG. 2, this known ZVS boost power converter is a modification of the hard switching boost converter of FIG. 1. Specifically, a capacitor C_2 is arranged across the switch S_1 . A first series circuit, including an inductor L_2 , a diode D_2 and a second switch S_2 , is also arranged in parallel with the switch S_1 . Further, a second series circuit, including a diode D_3 , a diode D_4 , and a resistor R_1 is arranged in parallel with the capacitor C_1 . The first and second series circuits are electrically coupled, from a node between the inductor L_2 and the diode D_2 of the first series circuit to a node between the diodes D_3 and D_4 of the second series circuit.

The operation of the known ZVS boost power converter is explained below. To achieve zero voltage switching of the switch S_1 , the auxiliary switch S_2 is turned-on (i.e., closed) near the end of the time switch S_1 is off (i.e., not conducting). Then, the current in the inductor L_2 increases until it reaches the level of the current in the input inductor L_1 . Simultaneously, the capacitor C_2 and the inductor L_2 create a resonance thereby reducing the voltage across the switch S_1 to zero before the switch S_1 is turned-on (closed). The diode D_1 is turned off (opened) without the problem of a high reverse recovery current passing through the switch S_1 . The capacitor C_2 minimizes the voltage across the switch S_1 to a very low value during turn-off (opening).

Unfortunately, this known ZVS boost power converter requires an active circuit element; namely, the second switch S_2 . Being an active element, the second switch S_2 requires additional supporting circuitry (e.g., a base drive circuit) and

introduces additional losses. The turn-off (opening) losses of the switch S_2 are significant because the inductor L_2 and the switch S_2 are carrying the load current before the switch S_2 is turned off (opened). Similarly, during the turn-on (closing) of the switch S_2 , the capacitor C_2 will discharge through L_2 and S_2 thereby causing additional power dissipation. Therefore: (i) the energy stored in the parasitic capacitance of the switch S_2 dissipates in the switch S_2 during the turn-on (closing); (ii) the switch S_2 experiences substantial turn-off (opening) losses because before the turn-off (opening) of the switch S_2 , it carries the full current of the inductor L_1 ; (iii) the inductor L_2 must be designed to limit any reverse recovery current spike from the diode D_1 during the turn-on (closing) of the switch S_2 ; (iv) the tailing effect of IGBTs (Insulated Gate Bipolar Transistors) during turn-off causes difficulties when using IGBTs in power converters having a power range of 3 to 5 KW.

Thus, the above mentioned known snubber circuits either: (a) use an active auxiliary switch in conjunction with the reactive elements (see e.g., the known ZVS boost power converter of FIG. 2) to relieve the voltage and current switching stresses of the controllable switch; or (b) use the controllable switch to provide energy to the circuit, that is, the energy used by the snubber circuit is drawn from the input and returned to the input.

Other known lossless power converters include resonant switching converters. These power converters incorporate reactive elements (capacitors and inductors) in conjunction with the switching device. The output voltage of these circuits is controlled by varying the operating frequency of the controllable switches. These circuits advantageously have low semiconductor switching losses and operate with sinusoidal waveforms. Unfortunately, resonant power converters exhibit increased component count, increased switching currents (peak and RMS) and require wide operating frequency variations to maintain a constant output voltage. Thus, resonant switching converters are relatively expensive, require relatively complex switching control circuitry, and eliminate switching losses at the expense of conducting losses.

A further example of a zero voltage switching (ZVS) quasi-resonant boost power converter is illustrated on page 14 of the Divan article. In this zero voltage switching (ZVS) boost power converter, a capacitor, along with an anti-parallel diode, are coupled across the controllable switch S_1 and an inductor is placed in series with the controllable switch S_1 . (See phantom lines in FIG. 1.) The operation of this power converter is explained below. During the turn-off of the switch S_1 , the inductor L_2 and the capacitor C_2 cause a resonance, thereby making the voltage across the switch S_1 nearly zero. Moreover, the switch S_1 is closed when its anti-parallel diode D_2 is conducting. Thus, the current is zero during turn-on (closing) of the switch S_1 . However, the current flowing through the switch S_1 is sinusoidal. Thus, the peak and RMS (root mean square) currents are increased. Consequently, as stated above, the quasi-resonant power converter eliminates switching losses at the expense of conduction losses. Furthermore, a wide range of operating switching frequencies is required to maintain a constant output voltage.

Therefore, although these known lossless boost power converters have better characteristics than the hard switching converters and non-lossless soft-switching boost power converters, certain disadvantages remain. Specifically, the known ZVS boost power converter requires an additional auxiliary switch which requires additional support circuitry (e.g., a base drive circuit) and which introduces additional

parasitic losses. Furthermore, the turn-off (opening) of the additional switch is not lossless as explained earlier. On the other hand, although resonant switching power converters eliminate switching losses, they introduce conducting losses. Moreover, as stated above, the output voltage in the resonant switching converters is controlled by frequency modulation. Therefore, this circuit requires additional circuitry to carry out such frequency modulation. Accordingly, an improved switching power converter employing an improved snubber network is needed.

The improved snubber network used by such a switching power converter should be a passive network; that is, the snubber network should include only resistors (not required in the present invention), capacitors, inductors, and diodes. The improved snubber network should use relatively inexpensive components. Moreover, the improved snubber network should enable the switching power converter to operate at higher switching frequencies to increase power density and to permit smaller components to be used. The improved snubber network should also eliminate reverse recovery current spikes in the switching power converter. The improved lossless soft switching power converter using the improved snubber network should also limit peak device voltage and current stresses, limit peak capacitor voltages, limit RMS currents in all components, have low sensitivity to second order effects (particularly when high switching frequencies are used), not require complex control circuitry, be fault tolerant, and have low electro-magnetic interference (EMI) and low radio frequency interference (RFI). Lastly, the improved snubber network should be adaptable for use in various switching power converter topologies such as boost, buck, forward, and flyback power converters.

SUMMARY OF THE INVENTION

The present invention provides an improved lossless soft switching power converter having no additional active components and having relatively low conduction losses compared to resonant topologies. The present invention does so by modifying conventional switching power converters by providing an improved snubber network.

The snubber network of the present invention is used with a device for converting power from an input voltage source to be supplied to an output load via a first inductor and a first diode, based on a duty cycle of a switching signal supplied to a controllable switch. The snubber network of the present invention includes three series connections. The first series connection includes an inductor, a diode, and a capacitor, the second series connection includes a capacitor and a diode, and the third series connection includes a diode and an inductor. The third series connection is arranged between the first and second series connection such that the inductor of the third series connection is coupled at a node between the diode and the capacitor of the first series connection and the diode of the third series connection is coupled at a node between the capacitor and the diode of the second series connection. More specifically, the inductor of the third series connection is coupled with the cathode of the diode of the first series connection and the cathode of the diode of the third series connection is coupled with the anode of the diode of the second series connection.

The snubber network of the present invention is incorporated into a power converter as follows. The first series connection is coupled across the controllable switch of the power conversion circuit, the second series connection is arranged such that the cathode of the diode of the second series connection is coupled with the output voltage appearing across the output load (or alternatively, with the input

voltage), and the third series connection is arranged between the first and second series connection such that the inductor of the third series connection is coupled at a node between the diode and the capacitor of the first series connection and the diode of the third series connection is coupled at a node between the capacitor and the diode of the second series connection.

In a preferred embodiment of the snubber network, a further inductor is coupled with the cathode of the diode of the power conversion circuit.

The snubber network of the present invention is designed for use with a switching power converter such that when the controllable switch is closed, voltage stored in the capacitor of the second series connection increases to the output voltage and when the controllable switch is opened, the voltage stored in the capacitor of the second series connection decreases to zero. Further, when the controllable switch is closed, voltage stored in the capacitor of the first series connection decreases from the output voltage to zero and when the controllable switch is opened, the voltage stored in the capacitor of the first series connection increases to the output voltage. The voltage of the first series connection may slightly overshoot the output voltage.

The snubber network of the present invention is designed for use with a switching power converter such that, at the instant when the controllable switch is opened, current through the controllable switch is relatively low such that switching losses are minimized. Further, at the instant when the controllable switch is closed, voltage across the controllable switch is relatively low such that switching losses are minimized.

In an alternative embodiment, the snubber network may also include a clamping diode coupled across the capacitor of the first series connection.

The snubber network of the present invention may be used with various switching power converter topologies such as boost power converters, buck power converters, forward power converters, and flyback power converters.

BRIEF DESCRIPTION OF THE DRAWINGS

FIG. 1 is a schematic that illustrates a conventional hard switching PWM power converter having a boost topology.

FIG. 2 is a schematic that illustrates a conventional ZVS soft switching boost power converter.

FIG. 3 is a schematic that illustrates the improved lossless soft switching PWM boost power converter employing the improved snubber network of the present invention and illustrates the state of the power converter at an instant just before the switch is turned-on (closed).

FIG. 4a is a schematic of the power converter of FIG. 3 that illustrates the operation of the power converter when the switch is closed. FIG. 4b is a schematic of the power converter of FIG. 3 which illustrates the initial condition of capacitor C_2 at an instant just before the switch is turned-off (opened). FIG. 4c is a schematic of the power converter of FIG. 3 that illustrates the operation of the power converter when the switch is open.

FIGS. 5a through 5c are timing diagrams illustrating the zero voltage turn-off and zero current turn-on of the switch of the improved lossless soft switching PWM boost converter of the present invention.

FIGS. 6a through 6i are timing diagrams illustrating the currents and voltages across various elements of the improved lossless soft switching PWM boost converter of the present invention.

FIG. 7 is a schematic of an alternative embodiment of a lossless boost power converter using the improved snubber network of the present invention.

FIG. 8 is a schematic of a lossless buck power converter using the improved snubber network of the present invention.

FIG. 9 is a schematic of an alternative embodiment of the lossless buck power converter using the improved snubber network of the present invention.

FIG. 10 is a schematic of a further alternative embodiment of the lossless buck power converter using the improved snubber network of the present invention.

FIG. 11 is a schematic of a lossless forward power converter using the improved snubber network of the present invention.

FIG. 12 is a schematic of a lossless flyback power converter using the improved snubber network of the present invention.

DETAILED DESCRIPTION

FIG. 3 is a schematic that illustrates a lossless soft switching PWM boost power converter which uses the improved passive snubber network of the present invention. As shown in FIG. 3, as with the known hard-switching power converter, the improved power converter of the present invention includes a voltage source V_{in} , an inductor L_1 , a diode D_1 , and an output load R_L , as well as a switch S_1 arranged in parallel with the current fed source network of V_{in} and L_1 .

The improved passive snubber network of the present invention used with this boost power converter, provides a first series circuit, having a saturable inductor L_3 , a diode D_2 and a capacitor C_3 , in parallel with the switch S_1 . The first series circuit has a first terminal coupled with a node between the inductor L_1 , the switch S_1 , the anode of the diode D_1 and capacitor C_2 and a second terminal coupled with the lower potential terminal of the input voltage source V_{in} . Thus, the first series circuit of the improved snubber network is arranged across the switch S_1 . Within the first series circuit, the inductor L_3 is coupled with the first terminal and the capacitor C_3 includes a first side coupled with the cathode of the diode D_2 and a second side coupled with the second terminal.

The improved snubber network of the present invention used with the boost power converter further provides a second series circuit, having capacitor C_2 and a diode D_3 , in parallel with the diode D_1 and the inductor L_4 . Within the second series circuit, the capacitor C_2 has a first side coupled with the anode of the diode D_3 and a second side coupled with the anode of the diode D_1 . Thus, the second series circuit of the improved snubber network is clamped to the output voltage appearing across the output load R_{out} .

The improved snubber network of the present invention used with the boost power converter also provides a third series circuit having an inductor L_2 and a diode D_4 . Within the third series circuit, a first terminal of the inductor L_2 is coupled at a node between the cathode of the diode D_2 and the capacitor C_3 of the first series circuit, a second terminal of the inductor L_2 is coupled with the anode of the diode D_4 , and the cathode of the diode D_4 is coupled at a node between the capacitor C_2 and the anode of the diode D_3 of the second series circuit.

The improved snubber network of the present invention used with the boost power converter may also include an inductor L_4 coupled with the cathode of the diode D_1 . This

inductor L_4 is used to reduce current spikes otherwise caused by the reverse recovery of the diode D_1 . Thus, the inductor L_4 helps reduce EMI and RF emission.

In the circuit of FIG. 3, the capacitance of the capacitor C_2 (which may have a value on the order of pico-farads) is much less than the capacitance of the capacitor C_3 (which may be on the order of micro-farads).

The overall operation of the boost power converter using the improved snubber network of the present invention is similar to the hard switching boost power converter of FIG. 1. The operation of the snubber network of the present invention when used in a boost power converter is explained below with reference to FIGS. 3, 4a through 4c, 5a through 5c, and 6a through 6f.

The state of the boost power converter of FIG. 3 at a time when the switch S_1 is turned off (not conducting), just before the switch S_1 is turned on, is as follows. Current flows to the output load via the inductor L_1 , the diode D_1 , and the inductor L_4 . Current flowing through the loop defined by the inductor L_1 , the capacitor C_2 , the diode D_3 , the load R_L , and the voltage supply charges the capacitor C_2 to less than one volt (i.e., a diode forward drop) (See FIG. 6f) and the capacitor C_3 to V_{out} (See FIG. 6h).

As shown in FIG. 4a, at a first instant in time, when the switch S_1 is first closed, a current will flow through a loop defined by the capacitor C_3 , the inductor L_2 , the diode D_4 , the capacitor C_2 , and the switch S_1 , thereby discharging the capacitor C_3 as shown in FIG. 6h and charging the capacitor C_2 as shown in FIG. 6f. This continues until the reversed charge on the capacitor C_2 reaches V_{out} . The value of the capacitor C_3 is selected such that when the charge on the capacitor C_2 reaches V_{out} , the charge on the capacitor C_3 will be zero. (See times t_1 and t_2 of FIGS. 6f and 6h). The charge on the capacitor C_2 and the discharging of the capacitor C_3 may occur about less than 1 (one) μ s after the switch S_1 is closed. If the voltage of the capacitor C_2 reaches V_{out} (plus the turn-on voltage of the diode D_3), the diode D_3 becomes forward biased thereby clamping the voltage of the capacitor C_2 to output voltage.

The current (I_{C2}) flowing through the loop defined by the capacitor C_3 , the inductor L_2 , the diode D_4 , the capacitor C_2 and the switch S_1 can be expressed by the following:

$$\frac{1}{C_3} \int I_{C2} dt + L_2 \frac{dI_{C2}}{dt} + \frac{1}{C_2} \int I_{C2} dt = 0 \quad (2)$$

where the power semiconductor forward voltage drops are neglected, and where $0 < t < t_1$.

This expression can be reduced to the following:

$$L_2 \frac{d^2 I_{C2}}{dt^2} + I_{C2} \left[\frac{1}{C_2} + \frac{1}{C_3} \right] = 0; \text{ or} \quad (3)$$

$$\frac{d^2 I_{C2}}{dt^2} + \frac{I_{C2}}{L_2} \left[\frac{1}{C_2} + \frac{1}{C_3} \right] = 0, \quad (4)$$

wherein $0 < t < t_1$.

A solution of this differential equation is given by:

$$I_{C2}(wt) = A \sin(\omega t) + B \cos(\omega t) \quad (5)$$

where

$$\begin{aligned} \omega &= \frac{1}{\sqrt{L_2 \left[\frac{1}{C_2} + \frac{1}{C_3} \right]}} \\ &= \frac{1}{\sqrt{\frac{L_2(C_2 + C_3)}{C_2 C_3}}} \\ &= \sqrt{\frac{C_2 C_3}{L_2(C_2 + C_3)}} \end{aligned}$$

where $0 < t < t_1$.

At time $t=0$, the switch S_1 is turned-on (closed) and $I_{C_2}(0)=0$. Therefore, $0=A \sin 0+B \cos 0$ and $B=0$. Accordingly,

$$I_{C_2}(t)=A \sin(\omega t) \tag{6}$$

The voltage of the capacitor C_3 is expressed as:

$$\begin{aligned} V_{C_3} &= \frac{1}{C_3} \int I_{C_2} dt \\ &= \frac{1}{C_3} \int A \sin(\omega t) dt \\ &= \frac{A}{\omega C_3} \cos(\omega t) \end{aligned} \tag{7}$$

At time $t=0$, $V_{C_3}=V_{OUT}$. Therefore:

$$V_{OUT} = \frac{A}{\omega C_3} \cos(0); \text{ and thus} \tag{8}$$

$$A = \omega C_3 V_{OUT} \tag{9}$$

Therefore, as shown in FIG. 6c, the current I_{C_2} can be expressed as:

$$I_{C_2}(t) = A \sin(\omega t) + B \cos(\omega t) \tag{10}$$

$$= \omega C_3 V_{OUT} \sin \omega t \tag{11}$$

where $0 < t < t_1$.

The operation of the DC to DC power converter is now explained with reference to FIG. 6b. Under steady state operating conditions, when the switch S_1 is turned-on (closed), the current in the inductor L_1 rises at a rate of $\frac{V_{in}}{L_1}$ and when the switch S_1 is turned-off (opened), the current falls at a rate of

$$\frac{V_{in} - V_{OUT}}{L_1}$$

The input current ripple can be controlled by controlling the frequency of the switching signal and the output power can be controlled by controlling the duty cycle of the switching signal. Specifically, the duty cycle is related to the input and output voltages from equation (1):

$$D = 1 - \frac{V_{OUT}}{V_{IN}} \tag{12}$$

V_{IN} is a DC voltage source in the case of a DC to DC power converter and $V_{IN}=|V^* \sin(\omega t)|$ in the case of an AC to DC power converter. Assuming a known input current in the case of a DC to DC power converter, the current I_{S_1} through the switch S_1 is the sum of the input current I_i times the duty cycle D , and the snubber current I_{C_2} derived above and illustrated in FIG. 6d. In other words: $I_{S_1}(\omega t) = I_i * D + I_{C_2}$

(where $0 \leq \omega t \leq t_{on}$). The current I_{S_1} through switch S_1 during turn-on is illustrated in FIG. 6d.

Further, when the switch S_1 is closed, the current I_{S_1} through the switch S_1 will not rise instantaneously because the inductor L_2 will continue to conduct a decaying current as shown in FIG. 5c. Therefore, after the switch S_1 is turned-on (closed), the current I_{S_1} through the switch S_1 will rise linearly as the current through the inductor L_2 decays linearly. (See FIGS. 5a and 5c.) This linear decay facilitates zero-current turning-on (closing) of the switch S_1 . Furthermore, the decaying current in the inductor L_2 causes the current through the diode D_1 to go to zero. The diode D_2 then turns-off. Thus, the current spike caused by diode reverse recovery associated with the known boost power converter design is eliminated.

As discussed above, after the switch S_1 is turned-on, the voltage of the capacitor C_2 reaches V_{OUT} and the voltage on the capacitor C_3 is zero, the current continuing to flow through the inductor L_2 decays to zero. That is, the energy stored in the inductor L_2 is given to the load R_L via diodes D_4 and D_3 . The decay of the current in the inductor L_2 occurs quickly because the voltage of the capacitor C_3 is much less than that of the capacitors C_1 and C_2 .

Consequently, when the switch S_1 is turned-on (closed), the current flowing through it I_{S_1} (See FIG. 6d) is a combination of: (i) the current flowing through the inductor L_1 (See FIG. 6b); and (ii) the current flowing from the capacitor C_3 to the capacitor C_2 via the inductor L_2 and the diode D_4 (See FIG. 6c).

When the switch S_1 is turned-on (closed), current also flows through the input voltage supply V_{in} , the inductor L_1 and the switch S_1 .

Thus, the state of the power converter of FIG. 4b at a time when the switch S_1 is on (conducting), just before the switch S_1 is turned off, is as follows. The voltage across the capacitor C_3 is zero (See FIG. 6h) and the voltage across the capacitor C_2 is V_{OUT} (See FIG. 6f). Since the charge on the capacitor C_2 is V_{OUT} , there is no voltage drop across the switch S_1 .

At this time, the switch S_1 is turned-off (opened) as shown in FIG. 4c and FIGS. 5a through 5c and 6a through 6i. As FIG. 4c further illustrates, the current of the inductor L_1 flows through: (i) a loop defined by the capacitor C_2 , the diode D_3 , the capacitor C_1 , and the voltage source V_{in} (see FIG. 6e); and (ii) a loop defined by the diode D_2 , the capacitor C_3 , and the voltage supply V_{in} . Therefore, the voltage rise of the capacitor C_3 depends on the value of the current flowing through L_1 before the switch S_1 is turned-off and the capacitance of the capacitor C_3 . The voltage of the capacitor C_2 is discharged at a rate determined by the value of the current flowing through the inductor L_1 just before the switch S_1 is turned-off and the capacitance of the capacitor C_2 .

Assuming that the capacitors C_2 and C_3 have the same capacitance, the design of the circuit can be simplified. For example, if the capacitors C_2 and C_3 have the same capacitance, the current flowing through the capacitor C_2 and the capacitor C_3 is half the value of the current I_{L_1} flowing through the inductor L_1 before the switch S_1 is turned-off. Therefore, the voltage rise across the switch S_1 during turn-off can be expressed as:

$$dV_{S_1}/dt = I_{L_1}/2C_3 \tag{13}$$

Using equation (13), the value of the capacitor C_3 for any given switch S_1 (at turn-off time) can be determined. During turn-off of the switch S_1 , the current through the switch S_1 starts decreasing and the magnitude of the current through

the capacitors C_2 and C_3 starts increasing as shown in FIGS. 6c, 6d, and 6e. Thus, the current I_{L1} through the inductor L_1 can be expressed as:

$$I_{L1}(t) = I_{S1}(t) + I_{C2}(t) + I_{C3}(t) \text{ where } T2 < t < T3. \quad (14)$$

As shown in FIG. 5a, the voltage across the switch S_1 will rise from zero to the voltage of the capacitor C_1 plus a small voltage (due to inductor L_4) until the diode D_1 becomes forward biased. The value of this switch voltage overshoot during turn-off is dictated by the inductance of the inductor L_4 . However, if the snubber network is designed properly, the overshoot will be limited to 60 to 70 volts higher than the output voltage V_{out} . This overshoot is not a problem in a boost power converter in the range of 3 to 5 KW. For example, a 4 KW power factor converter has been implemented using a 500 V MOSFET switch. In this converter, the peak voltage (including overshoot) of the switch was found to be 450 V. Thus, in such an implementation, the overshoot is not a problem. Once the diode D_1 starts conducting, the current flowing through the inductor L_1 begins to flow through the diode D_1 . These conditions remain the same until the next turn-on (closing) of the switch S_1 .

As described above with respect to a boost power converter topology, an improved snubber network in accordance with the present invention is provided. The improved snubber network comprises: (i) a first series connection of the inductor L_3 , the diode D_2 , and the capacitor C_3 coupled across the switch S_1 ; (ii) a second series connection of the capacitor C_2 and the diode D_3 arranged such that the capacitor C_2 is coupled with a terminal of the switch S_1 and the cathode of the diode D_3 is coupled with the output voltage appearing across the load R_L ; (iii) a third series connection of the diode D_4 and the inductor L_2 having a first end terminal coupled at a node between the diode D_2 and the capacitor C_3 of the first series connection and having a second end terminal coupled at a node between the capacitor C_2 and the diode D_3 of the second series connection; and (iv) the inductor L_4 coupled with the cathode of the diode D_1 . To reiterate, this improved snubber network uses only passive circuit elements.

The improved snubber network of the present invention can be used in other power converter topologies as well. In each case, the first series connection of the inductor L_3 , the diode D_2 , and the capacitor C_3 is coupled across the switch S_1 ; the second series connection of the capacitor C_2 and the diode D_3 is arranged such that the capacitor C_2 is coupled with a terminal of the switch S_1 and the cathode of the diode D_3 is coupled with the input voltage source V_{in} or with the output load R_{load} ; the third series connection is coupled between the first and second series circuit; and the inductor L_4 is coupled with the diode D_1 .

For example, the improved snubber network of the present invention can be used in the alternative boost power converter shown in FIG. 7. The alternative embodiment of the boost power converter shown in FIG. 7 differs from the embodiment shown in FIG. 3 in that: (i) the cathode of the diode D_3 is coupled with the input voltage source V_{in} rather than the output load R_{load} ; (ii) an additional capacitor C_4 is arranged across the input voltage source V_{in} ; and (iii) an additional diode D_5 is provided across the capacitor C_3 .

The operation of the alternative boost power converter of FIG. 7 is almost the same as the boost power converter of FIG. 3 except that: (i) the voltage stored by the capacitor C_2 is clamped to the input voltage and therefore changes between $+V_{in}$ and $-V_{in}$ during the turn-off of the switch S_1 ; and (ii) the diode D_5 prevents the capacitor C_3 from becoming negatively charged.

The improved snubber network can also be used in other power converter topologies. For example, FIGS. 8 through 10 are schematics showing the snubber network used in three embodiments of a buck converter topology. As shown in FIG. 1.1(a) on page 4 of the Divan article, a buck converter generally includes a series connection of an input voltage supply V_{in} (shown as V_1 in the Divan article), a controllable switch S_1 , an inductor L_1 , and an output load R_{load} . A diode D_1 (shown as S_2 in the Divan article) is arranged across the input voltage supply V_{in} such that its anode is coupled with a lower potential terminal of the input voltage supply V_{in} and its cathode is coupled at a node between the controllable switch S_1 and the inductor L_1 . An output capacitor C_1 is arranged across the output load R_{load} .

FIG. 8 is a schematic which shows a first embodiment of the buck power converter using the improved snubber network of the present invention in which (i) the first series circuit of the inductor L_3 , the diode D_2 and the capacitor C_3 is arranged across the controllable switch S_1 ; (ii) the second series circuit of the capacitor C_2 and the diode D_3 is arranged such that the capacitor C_2 is coupled with a terminal of the switch S_1 and the cathode of the diode D_3 is coupled with the output load R_{load} (alternatively, the cathode of the diode D_3 may be coupled with the input voltage supply V_{in}); (iii) the third series circuit of the diode D_4 and the inductor L_2 is arranged between the first and second series circuits; and (iv) the inductor L_4 is coupled with the anode of the diode D_1 . The voltage of the capacitor C_2 is clamped to V_{out} during turn-on of the switch S_1 and charges to $+V_{in}$ and $-V_{in}$ during turn-off of the switch S_1 . Similar to the boost power converter of FIG. 7, a diode D_5 is provided across the capacitor C_3 to prevent the capacitor C_3 from becoming negatively charged.

FIG. 9 is a schematic which shows a second embodiment of a buck power converter using the improved snubber network of the present invention, in which: (i) the first series circuit of the inductor L_3 , the diode D_2 and the capacitor C_3 is arranged across the controllable switch S_1 ; (ii) the second series circuit of the capacitor C_2 and the diode D_3 is arranged such that the capacitor C_2 is coupled with a terminal of the switch S_1 and the cathode of the diode D_3 is coupled with the output load R_{load} (alternatively, the cathode of the diode D_3 may be coupled with the input voltage supply V_{in}); (iii) the third series circuit of the diode D_4 and the inductor L_2 is arranged between the first and second series circuits; and (iv) the inductor L_4 is coupled with the anode of the diode D_1 . In this second embodiment of the buck power converter, the voltage of the capacitor C_2 is clamped to the voltage across the output load R_{load} . A diode D_5 may be coupled across the capacitor C_3 to prevent it from becoming negatively charged.

FIG. 10 shows a third embodiment of a buck power converter using the improved snubber network of the present invention, in which: (i) the first series circuit of the inductor L_3 , the diode D_2 and the capacitor C_3 is arranged across the controllable switch S_1 ; (ii) the second series circuit of the capacitor C_2 and the diode D_3 is arranged such that the capacitor C_2 is coupled with a terminal of the switch S_1 and the cathode of the diode D_3 is coupled with the input voltage source V_{in} (alternatively, the cathode of the diode D_3 may be coupled with the output load R_{load}); (iii) the third series circuit of the diode D_4 and the inductor L_2 is coupled between the first and second series circuits; and (iv) the inductor L_4 is coupled with the anode of the diode D_1 . An additional diode D_5 may be coupled across the capacitor C_3 to prevent the capacitor C_3 from becoming negatively charged.

FIG. 11 is a schematic which shows a forward power converter using the improved snubber network of the present invention. A conventional forward power converter is illustrated in FIG. 1.2(b) on page 4 of the Divan article. In the conventional forward power converter, a first loop is formed from a series connection of an input voltage source V_{in} (labeled V_1 in the Divan article), a primary winding of a transformer, and a controllable switch S_1 . A second loop includes a series connection of a diode D_2 (labeled S3 in the Divan article), the output load R_{load} (labeled as Z_L in the Divan article), the inductor L_1 , and the secondary of the transformer. An output capacitor C_1 , as well as a diode D_1 (labeled as S2 in the Divan article), are arranged across the output load R_{load} .

In the forward power converter including the improved snubber network of the present invention of FIG. 11: (i) the first series circuit of the inductor L_3 , the diode D_2 and the capacitor C_3 is arranged across the controllable switch S_1 ; (ii) the second series circuit of the capacitor C_2 and the diode D_3 is arranged such that the capacitor C_2 is coupled with a terminal of the switch S_1 and the cathode of the diode D_3 is coupled with the input voltage source V_{in} ; (iii) the third series circuit of the diode D_4 and the inductor L_2 is coupled between the first and second series circuits; and (iv) the inductor L_4 is coupled with the anode of the diode D_1 . In this forward power converter, the improved snubber network of the present invention clamps the voltage of the capacitor C_2 to V_{in} during the turn-on period of the switch S_1 . This circuit advantageously permits the PWM control to be used for output voltage control. A further diode D_5 may be arranged across the capacitor C_3 to prevent the capacitor C_3 from becoming negatively charged.

FIG. 12 is a schematic of a flyback power converter using the improved snubber network of the present invention. A conventional flyback power converter is shown in FIG. 1.2(a) of the Divan article. The conventional flyback power converter includes a first loop including a series connection of the input power supply V_{in} (labeled as V_1 in the Divan article), a primary winding of a transformer, and a controllable switch S_1 . The conventional flyback power converter further includes a second loop including a diode D_2 (labeled as S2 in the Divan article) an output load R_{load} (labeled as Z_1 in the Divan article), an inductor L_1 , and a secondary winding of the transformer. An output capacitor C_1 is arranged across the output load R_{load} , as is a diode D_1 .

The flyback power converter of FIG. 12, which includes the improved snubber network, includes: (i) the first series circuit of the inductor L_3 , the diode D_2 and the capacitor C_3 arranged across the controllable switch S_1 ; (ii) the second series circuit of the capacitor C_2 and the diode D_3 arranged such that the capacitor C_2 is coupled with a terminal of the switch S_1 and the cathode of the diode D_3 is coupled with the input voltage source V_{in} ; (iii) the third series circuit of the diode D_4 and the inductor L_2 coupled between the first and second series circuits; and (iv) the inductor L_4 is coupled with the anode of the diode D_1 . In the flyback power converter of FIG. 12, the improved snubber circuit clamps the voltage of the capacitor C_2 to V_{in} during the switch-on period of the controllable switch S_1 and allows zero current turn-on of the switch S_1 .

As described above with respect to the first embodiment of the boost power converter (See FIG. 3), when the switch S_1 is turned-off (opened), no voltage exists across it (See FIG. 5a), and when the switch S_1 is turned-on (closed), no current instantaneously flows through it (See FIG. 5c). Accordingly, the switch operation is lossless. Moreover, operation of the power converters using the snubber network

of the present invention at high switching frequencies is practical. Since the operation of the improved power converters using the snubber network of the present invention is practical at high switching frequencies, the power density of the power converter can be increased and smaller components can be used. Further, the lossless switching of the improved power converters using the snubber network of the present invention limits peak device voltage and current stresses, limits peak capacitor voltages, limits RMS currents in all components, is relatively insensitive to second order effects (particularly when high switching frequencies are used), and has relatively low electro-magnetic interference (EMI) and low radio frequency interference (RFI). Moreover, the improved power converters using the snubber network of the present invention reduces conducting losses and is operable with a fixed frequency switching signal.

Furthermore, the lossless operation of the improved power converters of the present invention is achieved with a snubber circuit employing only passive circuit elements. That is, the snubber circuit in the improved power converter of the present invention includes only capacitors, inductors, and diodes. Since the improved power converters of the present invention does not require any additional active elements, such as a transistor switch for example, the number of relatively expensive components is reduced.

Lastly, the improved converters using the snubber network of the present invention eliminate reverse recovery spikes because the decaying current through the inductor L_4 eliminates the diode reverse recovery of the diode D_1 .

What is claimed is:

1. A snubber network for use with a device for converting power from an input voltage source to be supplied to an output load via a first inductor and a first diode, based on a duty cycle of a switching signal supplied to a controllable switch, the snubber network comprising:

- a) a first series connection of an inductor, a diode, and a capacitor;
- b) a second series connection of a capacitor and a diode; and
- c) a third series connection of a diode and an inductor, the third series connection arranged between the first and second series connection such that the inductor of the third series connection is coupled at a node between the diode and the capacitor of the first series connection and the diode of the third series connection is coupled at a node between the capacitor and the diode of the second series connection.

2. The snubber network of claim 1 wherein the inductor of the third series connection is coupled with the cathode of the diode of the first series connection and wherein the cathode of the diode of the third series connection is coupled with the anode of the diode of the second series connection.

3. In a power conversion circuit which converts an input voltage to an output voltage supplied across a load based on a duty cycle of a switching signal supplied to a controllable switch, and which includes an inductor and a diode arranged in a main current path and a capacitor arranged across the load, a snubber network comprising:

- a) a first series connection of an inductor, a diode, and a capacitor, the first series connection being coupled across the controllable switch of the power conversion circuit;
- b) a second series connection of a capacitor and a diode, the second series connection being arranged such that the cathode of the diode of the second series connection is coupled with the output voltage; and

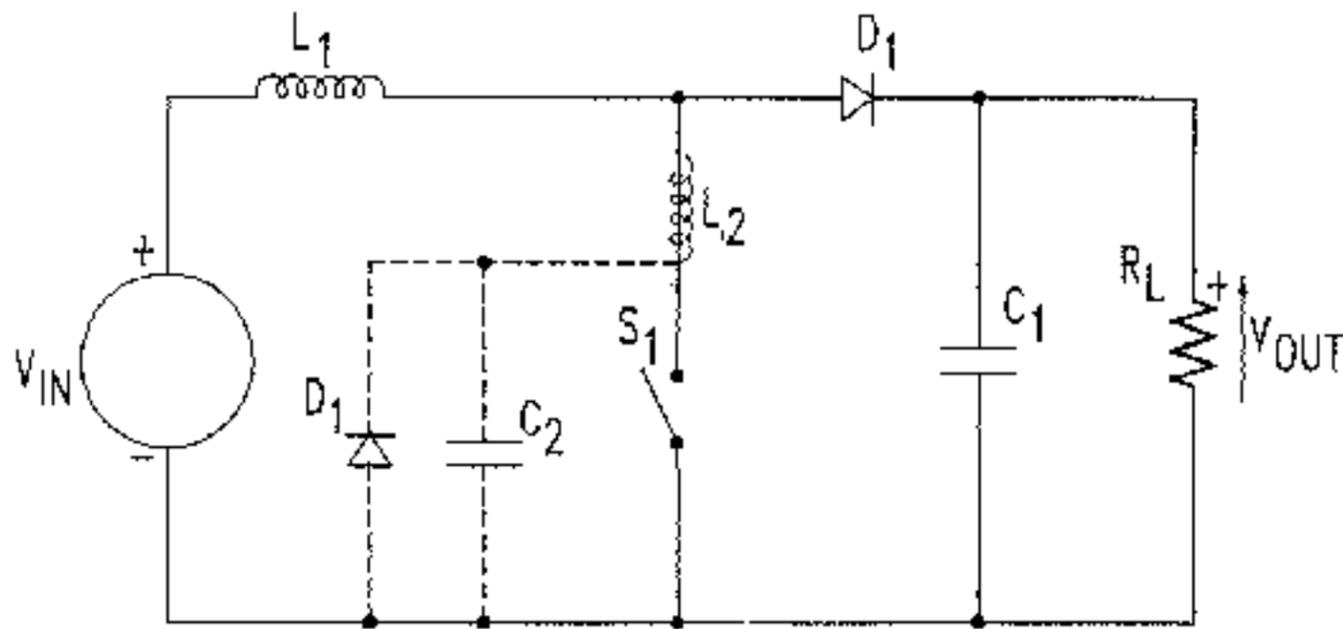

FIG. 1 (PRIOR ART)

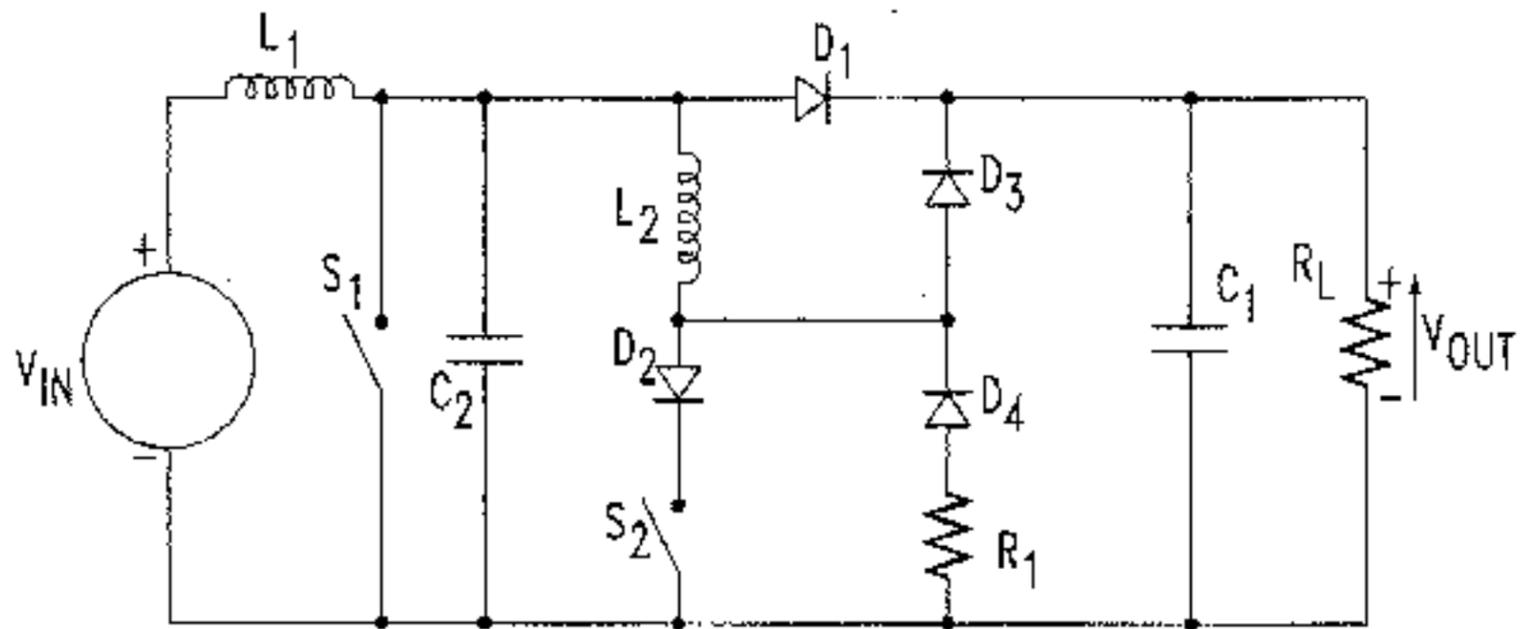

FIG. 2 (PRIOR ART)

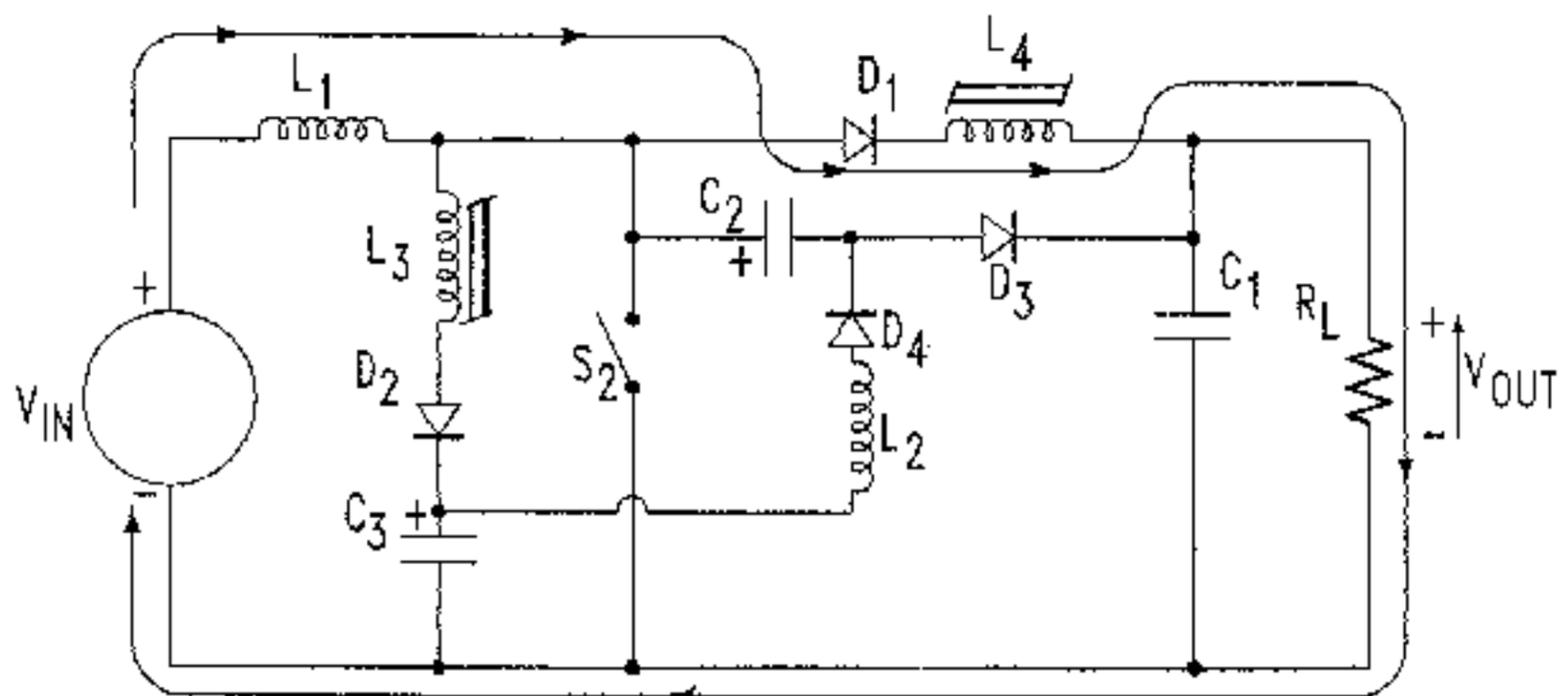

FIG. 3

c) a third series connection of a diode and an inductor, the third series connection arranged between the first and second series connection such that the inductor of the third series connection is coupled at a node between the diode and the capacitor of the first series connection and the diode of the third series connection is coupled at a node between the capacitor and the diode of the second series connection.

4. The snubber network of claim 3 further comprising a further inductor coupled with the cathode of the diode of the power conversion circuit.

5. The snubber network of claim 3 wherein when the controllable switch is closed, voltage stored in the capacitor of the second series connection increases to the output voltage and when the controllable switch is opened, the voltage stored in the capacitor of the second series connection decreases to zero.

6. The snubber network of claim 5 wherein when the controllable switch is closed, voltage stored in the capacitor of the first series connection decreases from the output voltage to zero and when the controllable switch is opened, the voltage stored in the capacitor of the first series connection quickly increases to the output voltage.

7. The snubber network of claim 6 wherein the voltage of the first series connection overshoots the output voltage.

8. The snubber network of claim 3 wherein, at the instant when the controllable switch is opened, current through the controllable switch is relatively low such that switching losses are minimized.

9. The snubber network of claim 3 wherein, at the instant when the controllable switch is closed, voltage across the controllable switch is relatively low such that switching losses are minimized.

10. The snubber network of claim 3 further comprising a clamping diode coupled across the capacitor of the first series connection.

11. The snubber network of claim 2 wherein the device for converting is a boost power converter.

12. The snubber network of claim 2 wherein the device for converting is a buck power converter.

13. The snubber network of claim 2 wherein the device for converting is a forward power converter.

14. The snubber network of claim 2 wherein the device for converting is a flyback power converter.

15. In a power conversion circuit which converts an input voltage to an output voltage supplied across a load based on a duty cycle of a switching signal, supplied to a controllable switch, and which includes an inductor and a diode arranged

in a main current path and a capacitor arranged across the load, a snubber network comprising:

a) a first series connection of an inductor, a diode, and a capacitor, the first series connection being coupled across the controllable switch of the power conversion circuit;

b) a second series connection of a capacitor and a diode, the second series connection being arranged such that the cathode of the diode of the second series connection is coupled with the input voltage; and

c) a third series connection of a diode and an inductor, the third series connection arranged between the first and second series connection such that the inductor of the third series connection is coupled at a node between the diode and the capacitor of the first series connection and the diode of the third series connection is coupled at a node between the capacitor and the diode of the second series connection.

16. The snubber network of claim 15 further comprising a further inductor coupled with the cathode of the diode of the power conversion circuit.

17. The snubber network of claim 15 wherein when the controllable switch is closed, voltage stored in the capacitor of the second series connection increases to the output voltage and when the controllable switch is opened, the voltage stored in the capacitor of the second series connection decreases to zero.

18. The snubber network of claim 13 wherein when the controllable switch is closed, voltage stored in the capacitor of the first series connection decreases from the output voltage to zero and when the controllable switch is opened, the voltage stored in the capacitor of the first series connection quickly increases to the output voltage.

19. The snubber network of claim 18 wherein the voltage of the first series connection overshoots the output voltage.

20. The snubber network of claim 15 wherein, at the instant when the controllable switch is opened, current through the controllable switch is relatively low such that switching losses are minimized.

21. The snubber network of claim 15 wherein, at the instant when the controllable switch is closed, voltage across the controllable switch is relatively low such that switching losses are minimized.

22. The snubber network of claim 15 further comprising a clamping diode coupled across the capacitor of the first series connection.

* * * * *

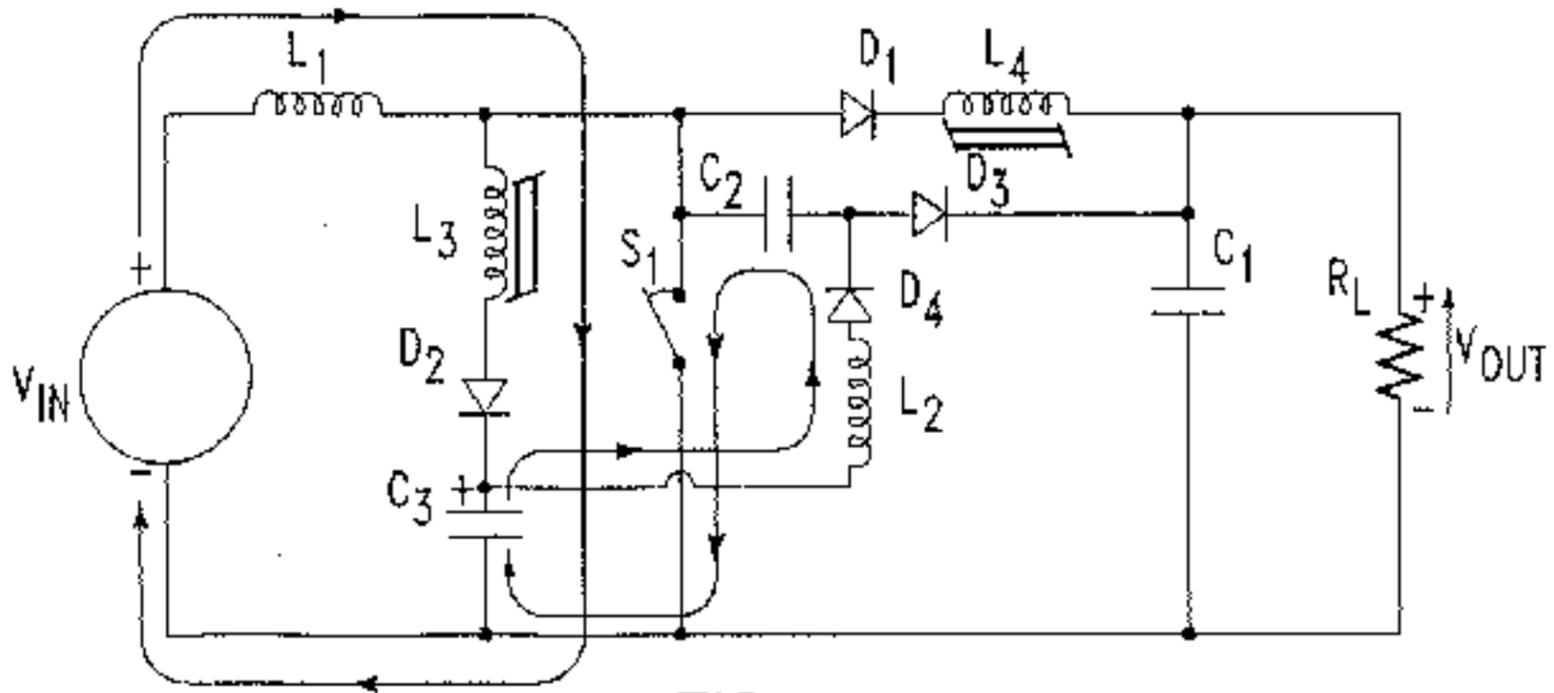

FIG. 4a

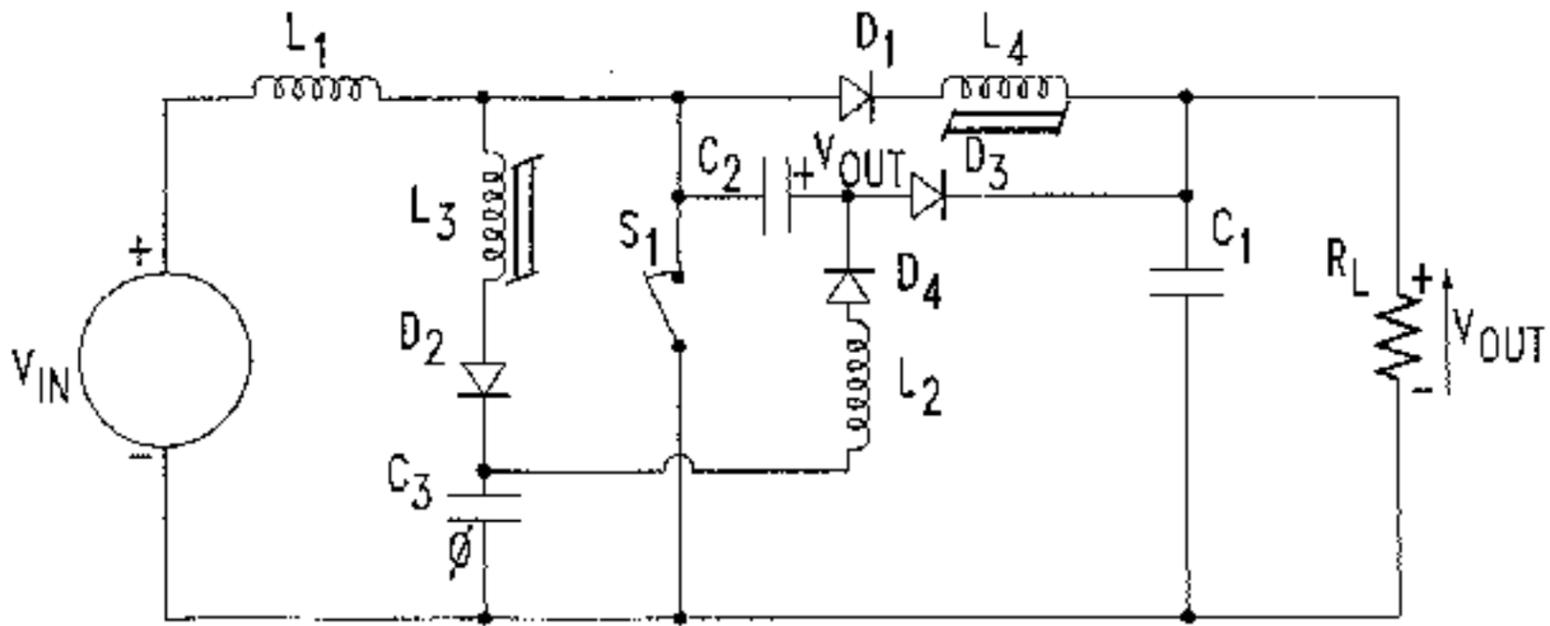

FIG. 4b

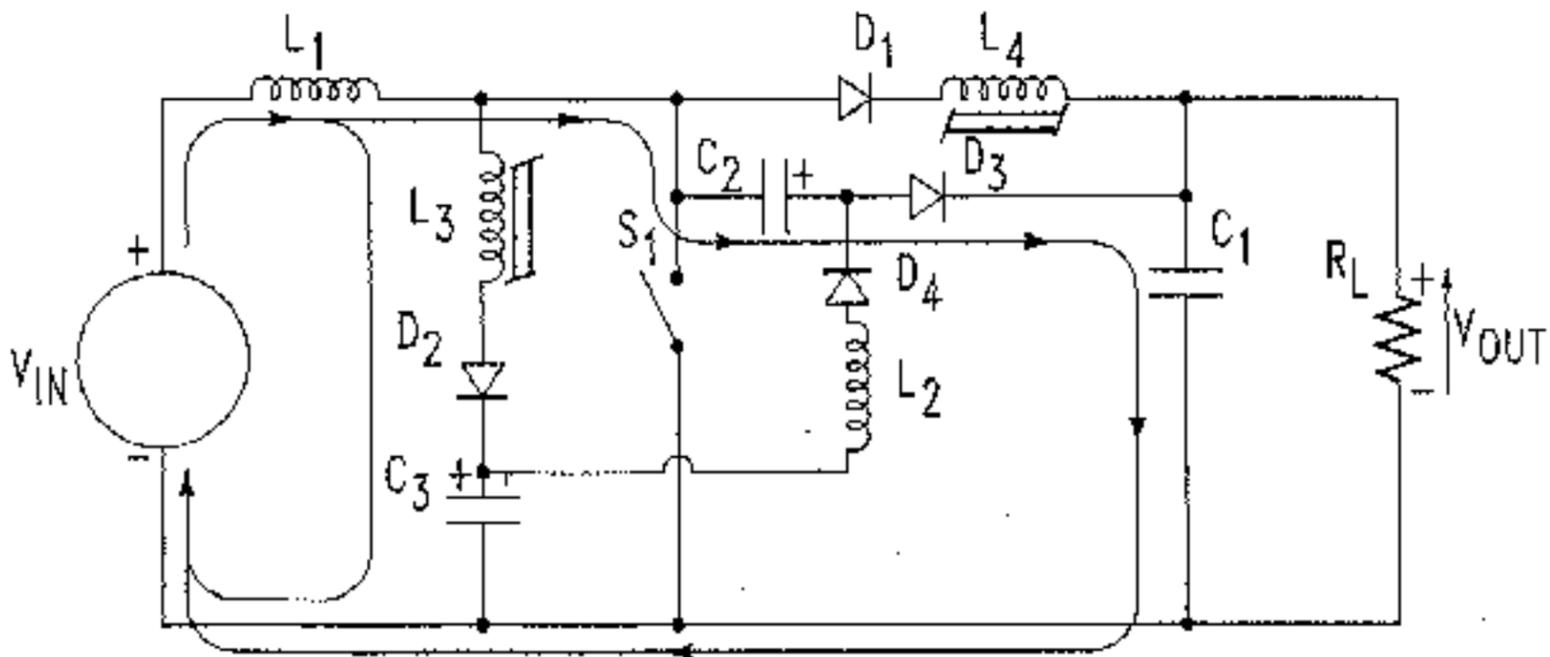

FIG. 4c

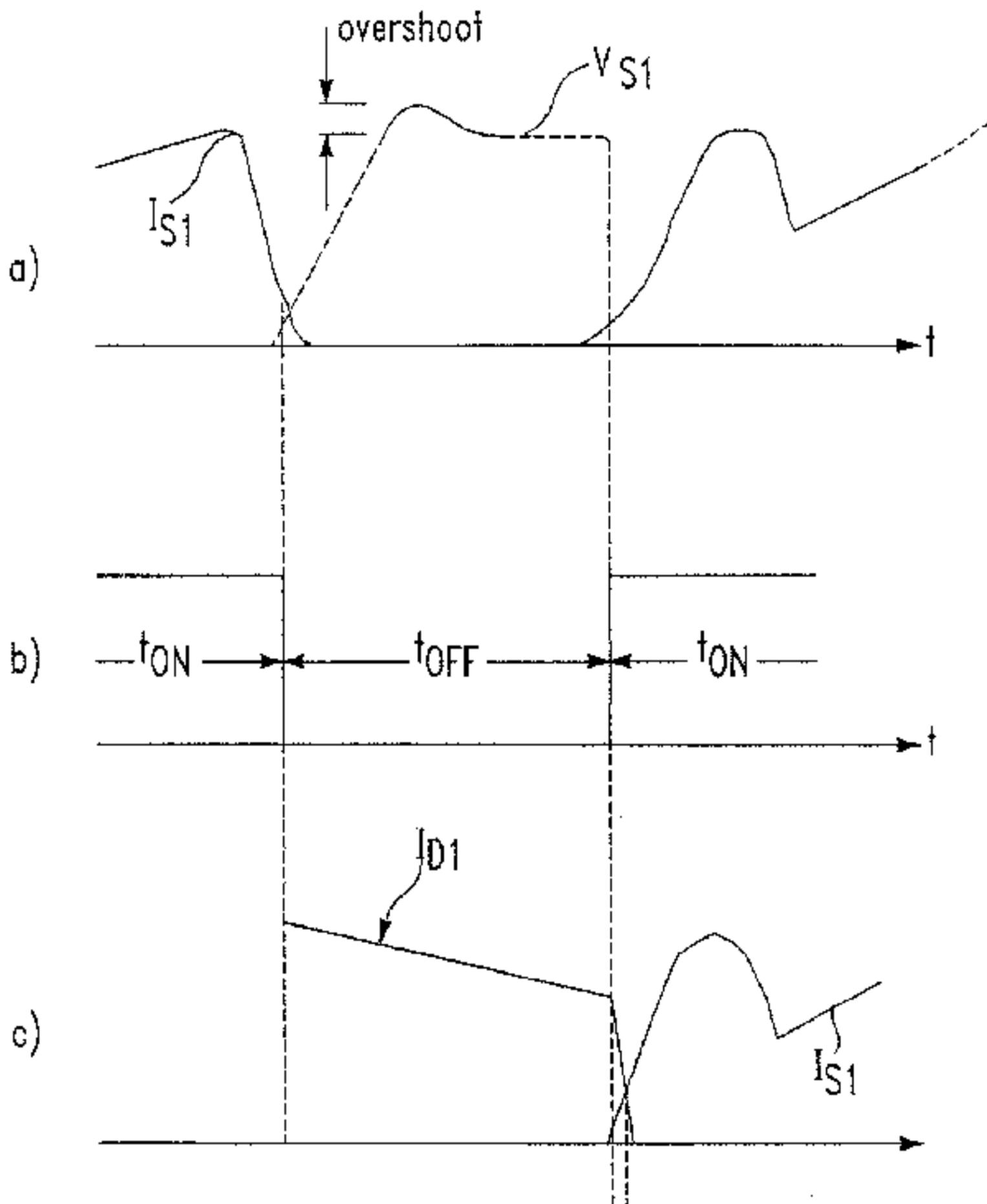

FIG. 5

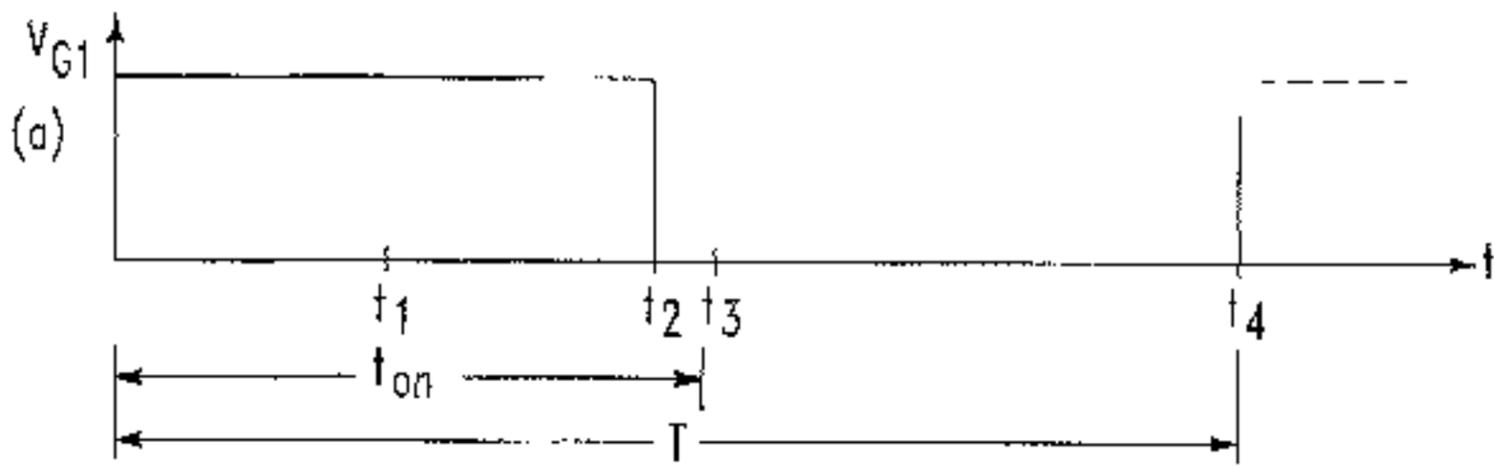

FIG. 6a

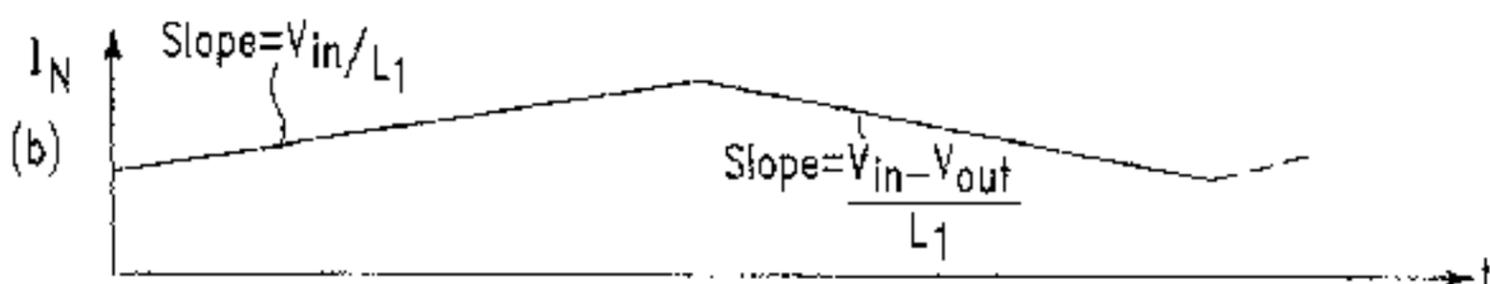

FIG. 6b

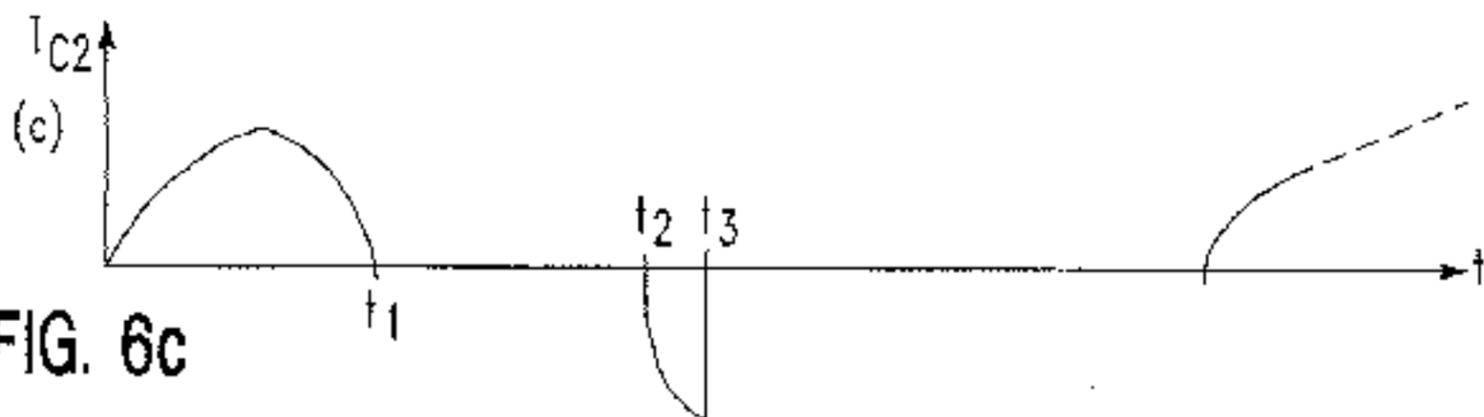

FIG. 6c

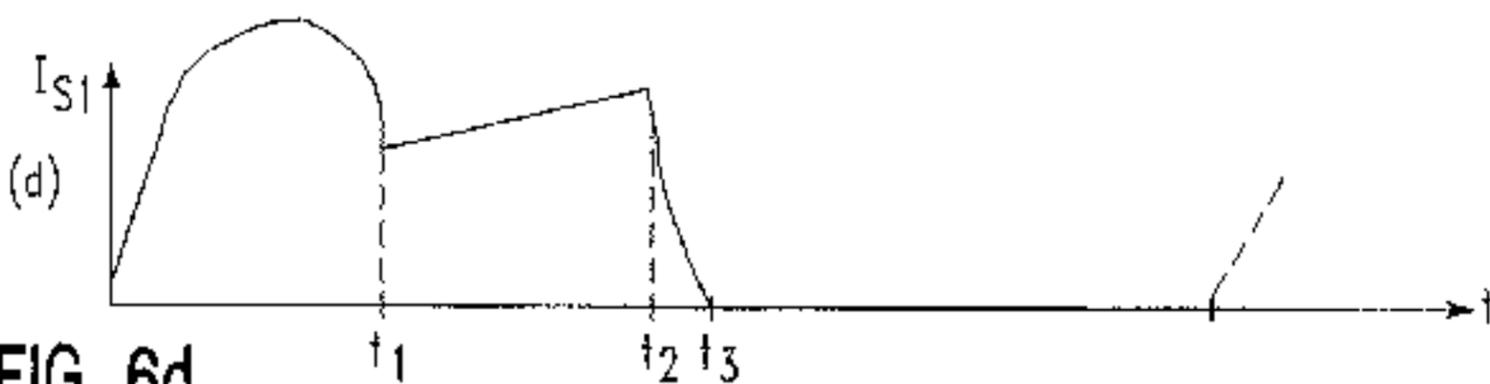

FIG. 6d

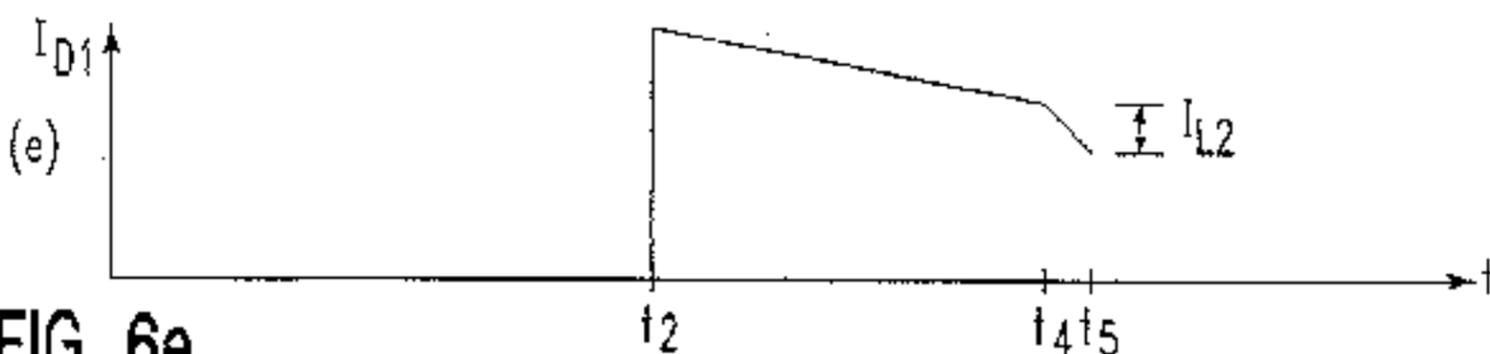

FIG. 6e

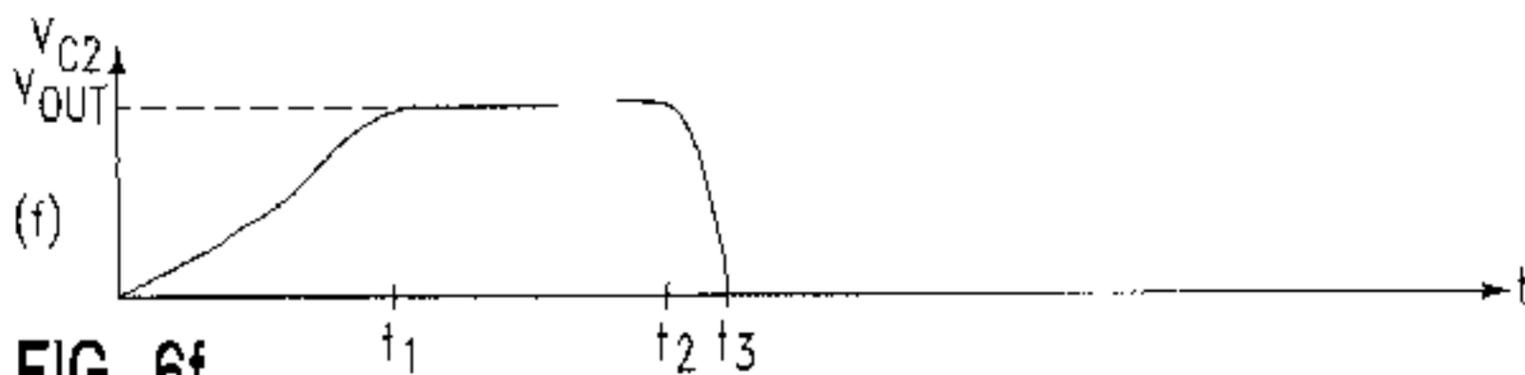

FIG. 6f

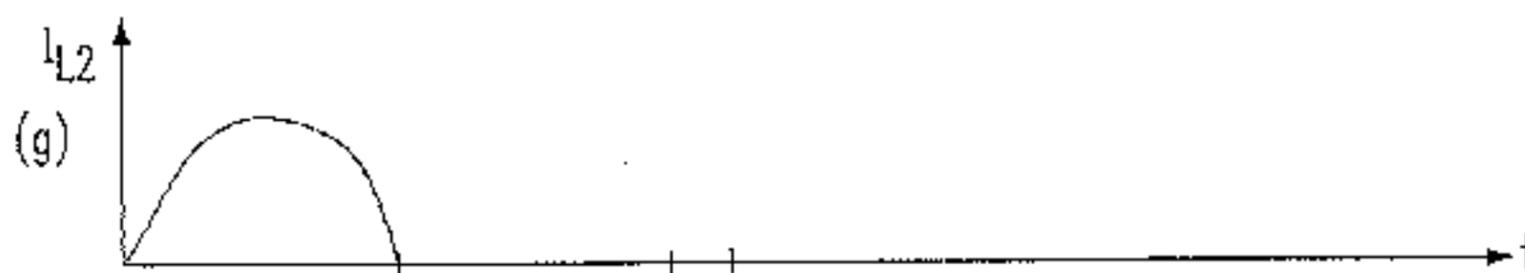

FIG. 6g

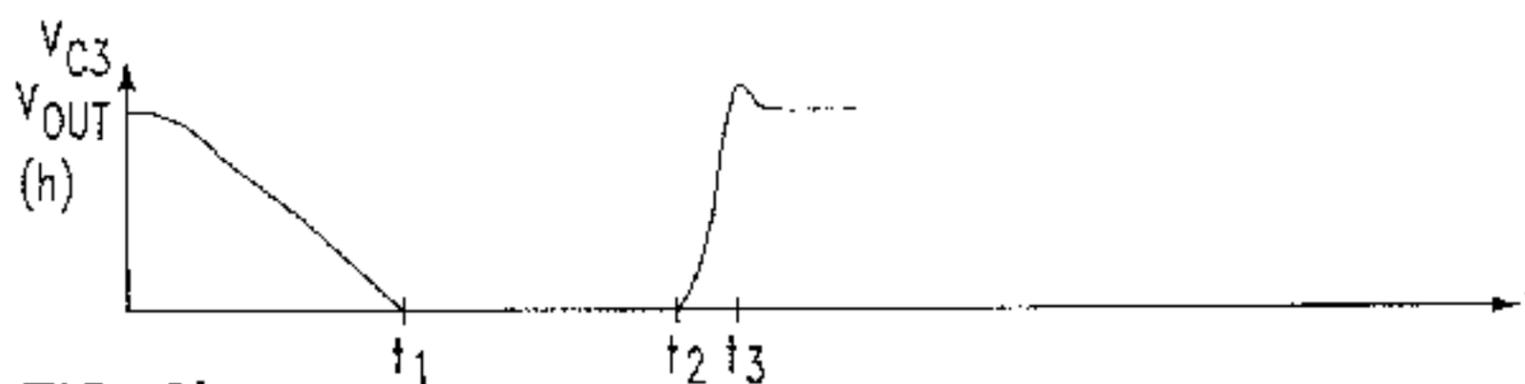

FIG. 6h

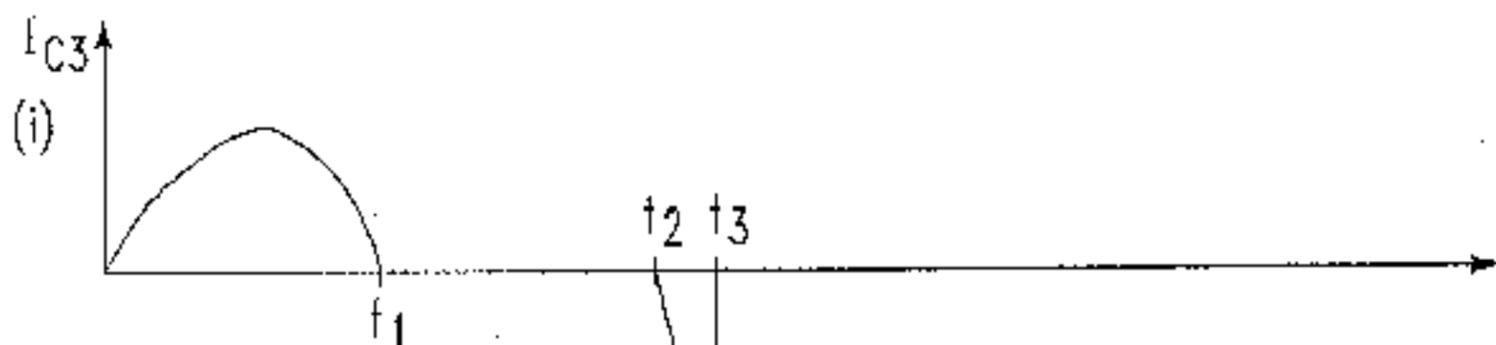

FIG. 6i

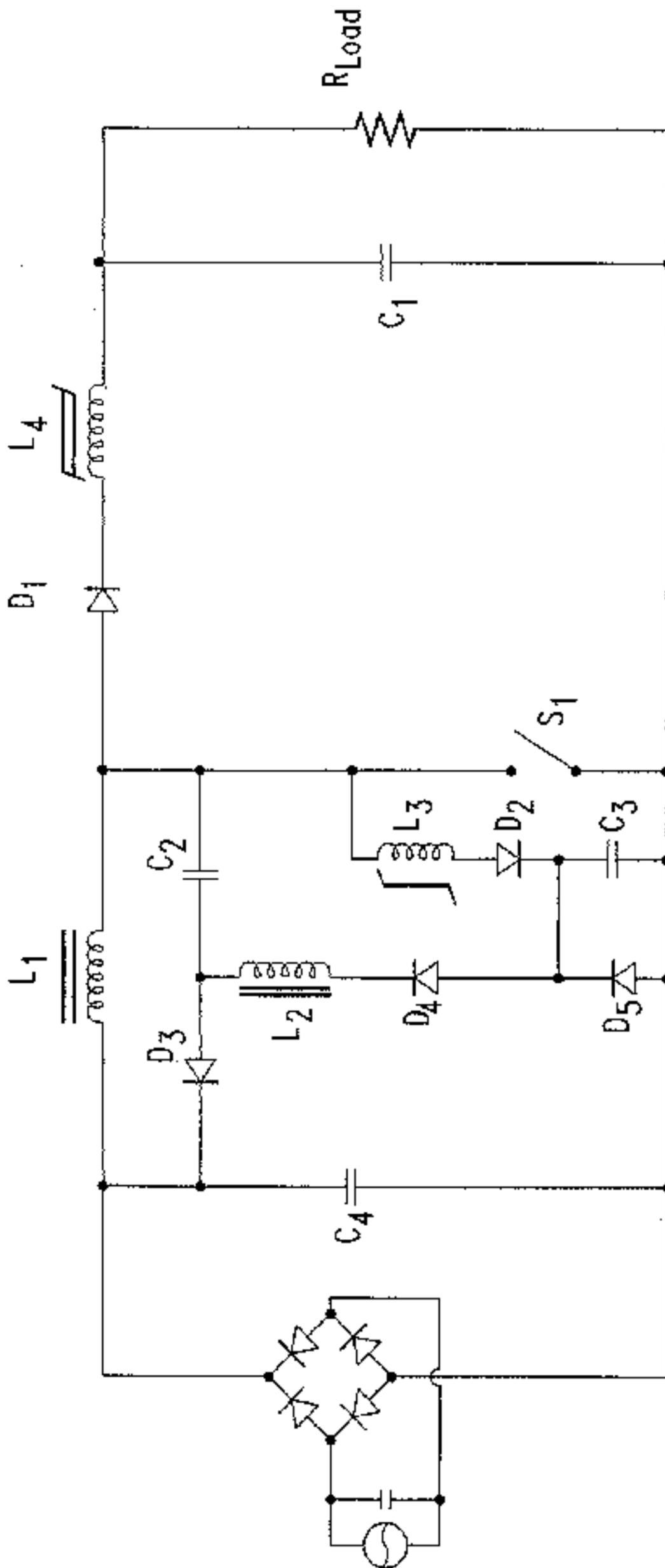

FIG. 7

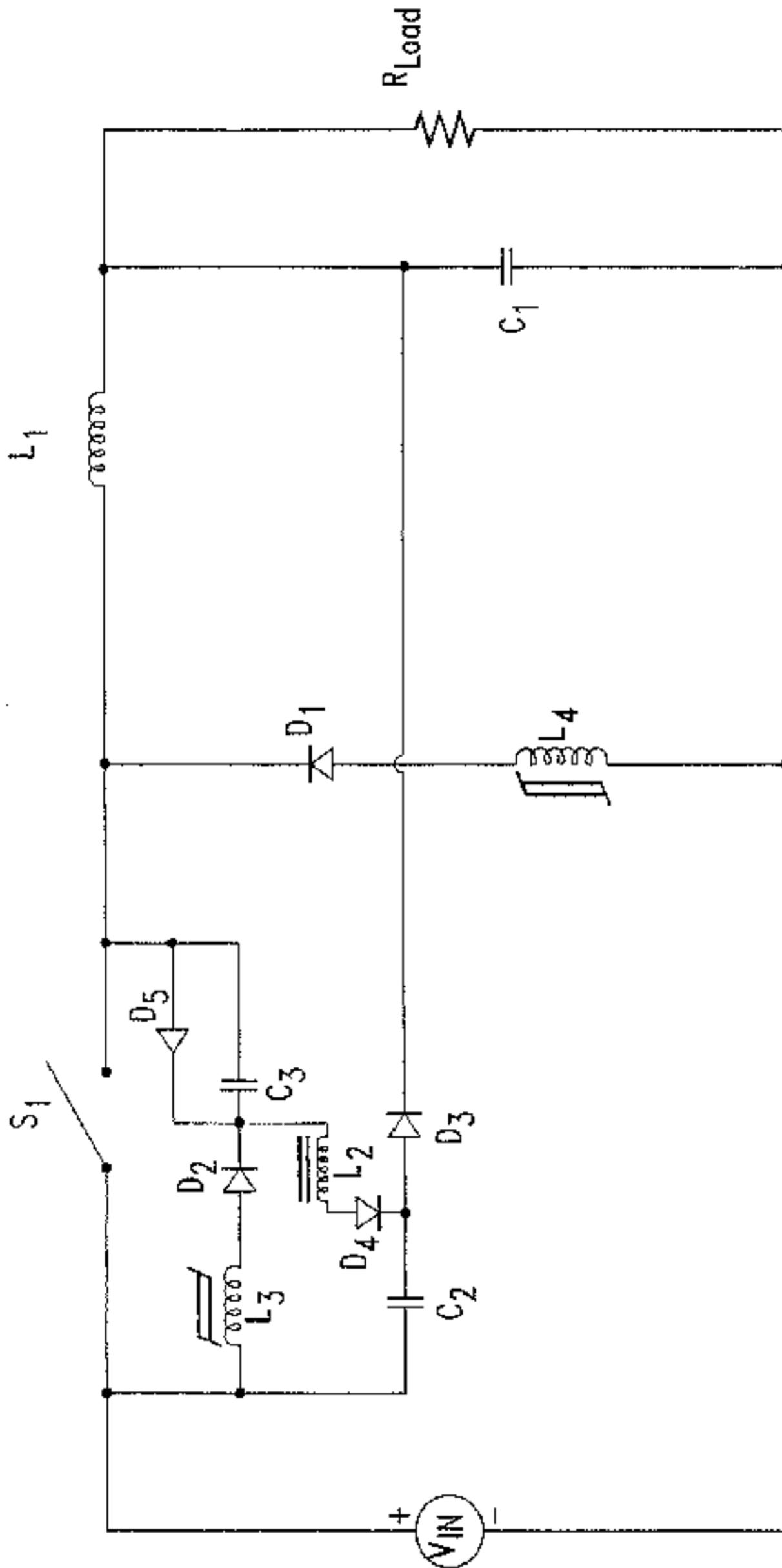

FIG. 8

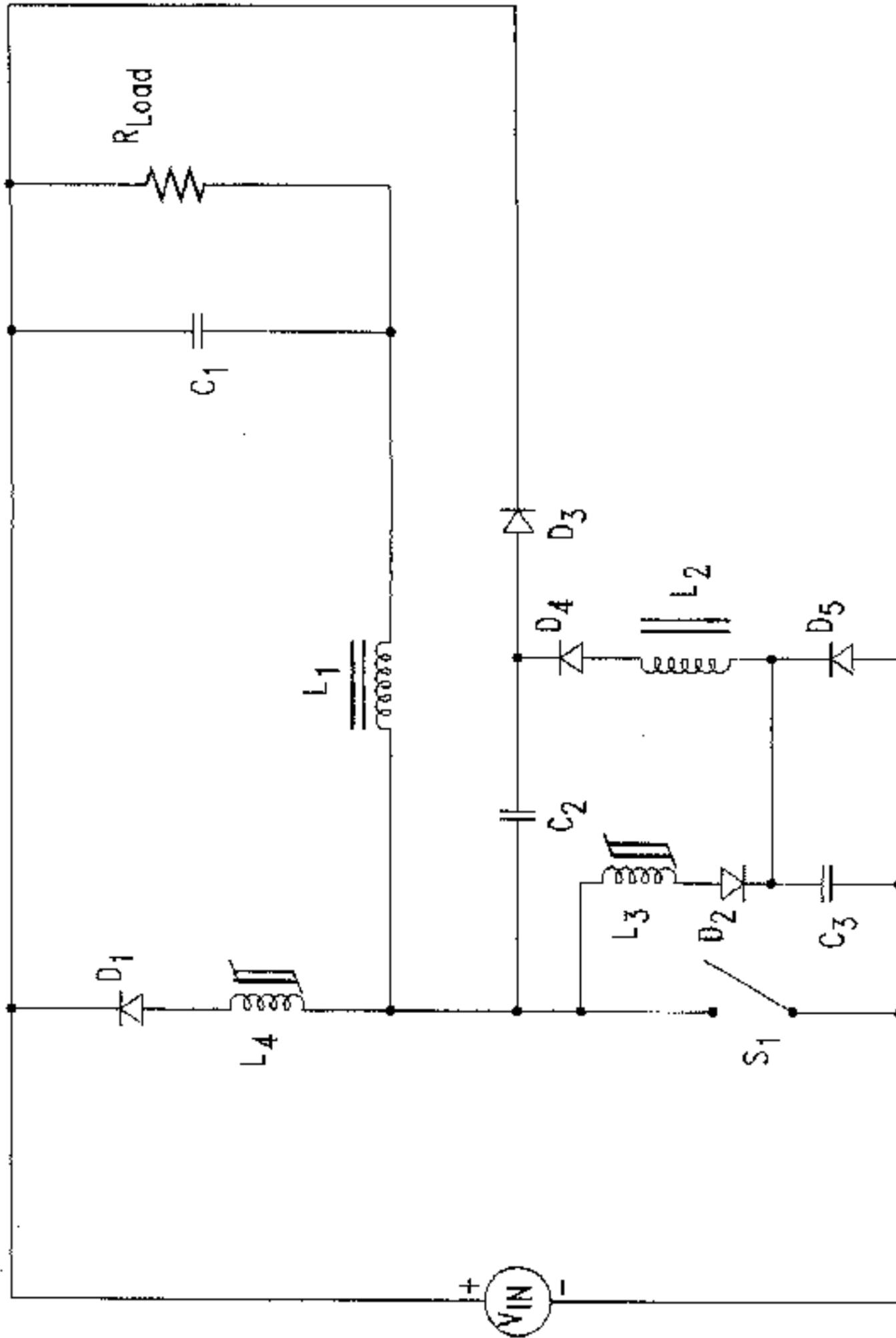

FIG. 9