

EPS1U

Power Supply Design Guide

***A Server System Infrastructure (SSI) Specification
For 1U Rack Chassis Power Supplies***

Version 2.0

Revision History		
Orig./Rev.	Description of Changes	Date
1.1	Initial release of EPS1U specification	
2.0	Added higher power levels for 400W, 450W, and 500W power supplies. Added a longer 355mm form factor for the 450W and 500W power levels. Added requirements for the higher power levels: 3 rd 240VA channel, output connector, efficiency, and output loading. Updated requirements for PSON#, PWOK, and ACWarning.	9/24/2002

Disclaimer:

THIS SPECIFICATION IS PROVIDED "AS IS" WITH NO WARRANTIES WHATSOEVER, INCLUDING ANY WARRANTY OF MERCHANTABILITY, NONINFRINGEMENT, FITNESS FOR ANY PARTICULAR PURPOSE, OR ANY WARRANTY OTHERWISE ARISING OUT OF ANY PROPOSAL, SPECIFICATION OR SAMPLE. WITHOUT LIMITATION, THE PROMOTERS (Intel Corporation, Dell Computer Corporation, Hewlett Packard Company, Silicon Graphics Inc., and International Business Machines Corporation) DISCLAIM ALL LIABILITY FOR COST OF PROCUREMENT OF SUBSTITUTE GOODS OR SERVICES, LOST PROFITS, LOSS OF USE, LOSS OF DATA OR ANY INCIDENTAL, CONSEQUENTIAL, DIRECT, INDIRECT, OR SPECIAL DAMAGES, WHETHER UNDER CONTRACT, TORT, WARRANTY OR OTHERWISE, ARISING IN ANY WAY OUT OF USE OR RELIANCE UPON THIS SPECIFICATION OR ANY INFORMATION HEREIN.

The Promoters disclaim all liability, including liability for infringement of any proprietary rights, relating to use of information in this specification. No license, express or implied, by estoppel or otherwise, to any intellectual property rights is granted herein.

This specification and the information herein is the confidential and trade secret information of the Promoters. Use, reproduction and disclosure of this specification and the information herein is subject to the terms of the S.S.I. Specification Adopter's Agreement.

Copyright © Intel Corporation, Dell Computer Corporation, Hewlett Packard Company, Silicon Graphics Inc., International Business Machines Corporation, 2001.

Contents

1	Purpose	5
2	Conceptual Overview	5
3	Definitions/Terms/Acronyms	6
4	Mechanical Overview	7
4.1	Card Edge Form Factor	7
4.2	Wire Harness	8
4.3	Airflow Requirements	9
4.4	Temperature Requirements	9
5	AC Input Requirements	10
5.1	AC Inlet Connector	10
5.2	AC Input Voltage Specification	10
5.3	Input Under Voltage	10
5.4	Efficiency	11
5.5	AC Line Dropout	11
5.6	AC Line Fuse	11
5.7	AC Inrush	12
5.8	AC Line Transient Specification	13
5.9	AC Line Fast Transient Specification	13
6	DC Output Specification	14
6.1	Connector	14
6.1.1	Power Connector (125W, 250W, 350W, 400W)	14
6.1.2	Power Connector (450W, 500W)	16
6.2	Grounding	18
6.3	Remote Sense	18
6.4	Output Power/Currents	18
6.4.1	Standby Outputs	22
6.5	Voltage Regulation	Error! Bookmark not defined.
6.6	Dynamic Loading	22
6.7	Capacitive Loading	23
6.8	Ripple / Noise	23
6.9	Timing Requirements	24
7	Protection Circuits	27
7.1	Current Limit	27
7.2	240VA Protection	27
7.3	Over Voltage Protection	28
7.4	Over Temperature Protection	28
8	Control and Indicator Functions	29
8.1	PSON [®]	29
8.2	PWOK (Power OK)	30
8.3	ACWarning	31
8.4	Field Replacement Unit (FRU) Signals	32
8.4.1	FRU Data	32
8.4.2	FRU Data Format	32

8.5	LED Indicator	34
9	MTBF.....	34
10	Agency Requirements.....	35

Figures

Figure 1:	Enclosure Drawing.....	7
Figure 2:	Alternate Enclosure Drawing	8
Figure 3:	Edge Finger Layout	15
Figure 4:	Edge Finger Layout	17
Figure 5:	Output Voltage Timing.....	24
Figure 6:	Turn On/Off Timing (Signal Power Supply).....	26
Figure 7:	PSON# Signal Characteristics	29

Tables

Table 1:	Definitions, Terms, and Acronyms (listed alphabetically).....	6
Table 2:	Thermal Requirements	9
Table 3:	AC Input Voltage Rating.....	10
Table 4:	Efficiency.....	11
Table 5:	AC Line Sag Transient Performance.....	13
Table 6:	AC Line Surge Transient Performance.....	13
Table 7:	Edge Finger Pinout	14
Table 8:	Edge Finger Pinout	16
Table 9:	125 W Load Ratings	19
Table 10:	250 W Load Ratings	19
Table 11:	350 W Load Ratings	20
Table 12:	400 W Load Ratings	20
Table 13:	450 W Load Ratings	21
Table 14:	500 W Load Ratings	21
Table 15:	Voltage Regulation Limits	22
Table 16:	Optional +5V Regulation Limits	22
Table 17:	Transient Load Requirements	23
Table 18:	Capacitive Loading Conditions	23
Table 19:	Ripple and Noise.....	23
Table 20:	Output Voltage Timing	24
Table 21:	Turn On/Off Timing.....	25
Table 22:	Over Current Protection	27
Table 23:	Over Current Protection	28
Table 24:	Over Voltage Limits	28
Table 25:	PSON# Signal Characteristic.....	29
Table 26:	PWOK Signal Characteristics.....	30
Table 27:	ACWarning Signal Characteristics	31
Table 28:	FRU Device Information	32
Table 29:	FRU Device Product Information Area.....	32
Table 30:	FRU Device MultiRecord Area.....	33
Table 31:	LED Indicators	34

1 Purpose

This specification defines non-redundant power supplies that support 1U rack mount entry server systems. The entry-level power supply is not intended to be a hot swap type of power supply. The parameters of this supply are defined in this specification for open industry use. This specification defines a 125W, 250 W and 350 W power supply with six outputs: 3.3 V, 5 V, 12 V, -12 V, and 5 VSB. The form factor fits into a 1U system and provides a wire harness or docking solution for output connections. An IEC connector is provided on the external face for AC input to the power supply. The power supply contains fans for cooling, while meeting acoustic requirements.

2 Conceptual Overview

In the Entry server market, the bulk power system must source power on several output rails.

These rails are typically as follows:

- +3.3 V
- +5 V
- +12 V
- -12 V
- 5V standby

NOTE

Local DC-DC converters shall be utilized for processor power, and will ideally convert power from the +12 V rail, however, they may also convert power from other rails.

The bulk power system may be an n+1 redundant power system or a non-redundant power system.

3 Definitions/Terms/Acronyms

Table 1: Definitions, Terms, and Acronyms (listed alphabetically)

Required	The status given to items within this design guide, which are required to meet SSI guidelines and a large majority of system applications.
Recommended	The status given to items within this design guide which are not required to meet SSI guidelines, however, are required by many system applications.
Optional	The status given to items within this design guide, which are not required to meet SSI guidelines, however, some system applications may optionally use these features.
Full Ranging	A full-ranging power supply automatically senses and adjusts itself to the proper input voltage range (110 VAC or 220 VAC). No manual switches or manual adjustments are needed.
CFM	Cubic Feet per Minute (airflow).
Dropout	A condition that allows the line voltage input to the power supply to drop to below the minimum operating voltage.
Latch Off	A power supply, after detecting a fault condition, shuts itself off. Even if the fault condition disappears the supply does not restart unless manual or electronic intervention occurs. Manual intervention commonly includes briefly removing and then reconnecting the supply, or it could be done through a switch. Electronic intervention could be done by electronic signals in the Server System.
Monotonically	A waveform changes from one level to another in a steady fashion, without intermediate retracement or oscillation.
MTBF	Mean time between failure
Noise	The periodic or random signals over frequency band of 0 Hz to 20 MHz.
Overcurrent	A condition in which a supply attempts to provide more output current than the amount for which it is rated. This commonly occurs if there is a "short circuit" condition in the load attached to the supply.
PFC	Power Factor Corrected.
PWOK	A typical logic level output signal provided by the supply that signals the Server System that all DC output voltages are within their specified range.
Ripple	The periodic or random signals over a frequency band of 0 Hz to 20 MHz.
Rise Time	Rise time is defined as the time it takes any output voltage to rise from 10% to 95% of its nominal voltage.
Sag	The condition where the AC line voltage drops below the nominal voltage conditions.
Surge	The condition where the AC line voltage rises above nominal voltage.
VSB or Standby Voltage	An output voltage that is present whenever AC power is applied to the AC inputs of the supply.

4 Mechanical Overview

STATUS
Required

There are two physical sizes of the power supply enclosure intended to accommodate different power levels from 125W up to 500W. There are two output connector designs. A card edge solution to provide ease of installation and removal and a wire harness to provide a traditional cabled solution. The chassis for the entry 1U power supply is designed for use in 1U rack mounted systems.

4.1 Card Edge Form Factor

The card edge form factor is intended to allow users and manufacturers easy installation and removal of the power supply into the system. Refer to Figure 1 for details. There are three different lengths for use with different power levels. The recommended length for each power level is shown below.

Length	Recommended power levels
215mm	125W, 250W
300mm	250W, 350W, 400W
355mm	450W, 500W

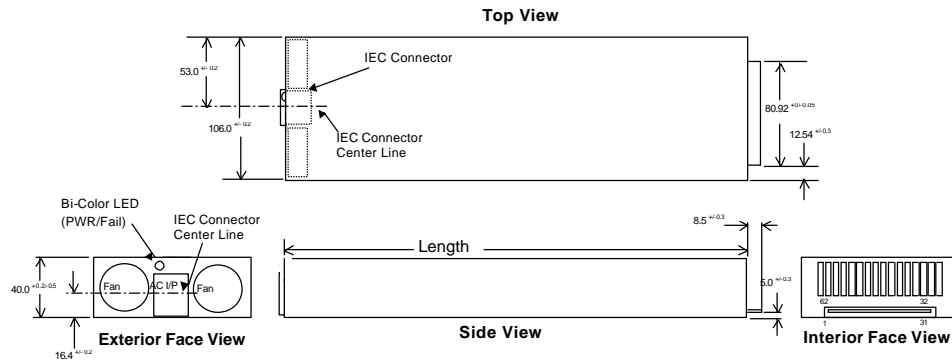

All dimensions are in millimeters.

Figure 1: Enclosure Drawing

4.2 Wire Harness

STATUS
Low Power Form Factor

Systems may require a wire harness connection directly from the power supply to the system. Figure 2 shows the wire harness version details. Refer to the Entry Electronics Bay Specification at the SSI web site (http://www.ssiforum.org/docs/entry_elec_bay_spec_v2_0.pdf) for possible output connector configurations. Due to different system board layouts the wire harness length may vary.

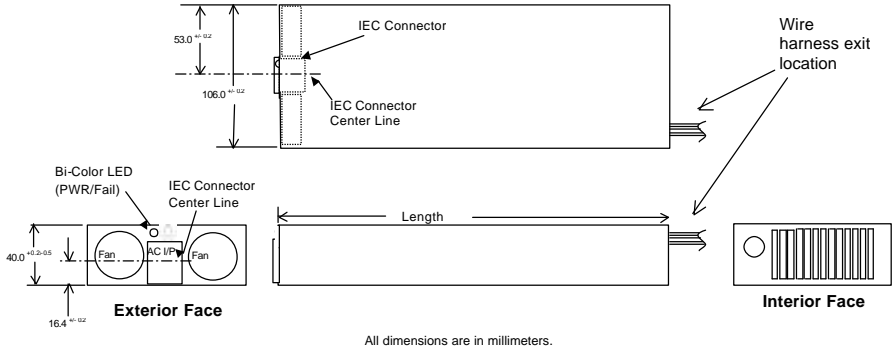

Figure 2: Alternate Enclosure Drawing

4.3 Airflow Requirements

STATUS
Recommended

The power supply shall have a two-speed fan(s) and provide cooling to both the supply and the system. During low-speed fan operation, the power supply shall not exceed a noise level of 38 dBA measured at one meter on all faces. At low fan speed, the power supply shall provide a minimum of 6 CFM of airflow with 0.003 inH2O of system backpressure. At high fan speed, the power supply shall provide a minimum of 10 CFM with 0.006 inH2O of system backpressure.

4.4 Temperature Requirements

STATUS
Recommended

The power supply shall operate within all specified limits over the T_{op} temperature range. All airflow shall pass through the power supply and not over the exterior surfaces of the power supply.

Table 2: Thermal Requirements

Item	Description	MIN	MAX	Units
T_{op}	Operating temperature range.	0	45	°C
T_{non-op}	Non-operating temperature range.	-40	70	°C

The power supply must meet UL enclosure requirements for temperature rise limits. All sides of the power supply, with exception to the air exhaust side, must be classified as "Handle, knobs, grips, etc. held for short periods of time only".

5 AC Input Requirements

STATUS
Required

The power supply shall incorporate universal power input with active power factor correction, which shall reduce line harmonics in accordance with the EN61000-3-2 and JEIDA MITI standards.

5.1 AC Inlet Connector

STATUS
Required

The AC input connector shall be an IEC 320 C-14 power inlet. This inlet is rated for 15 A / 250 VAC.

5.2 AC Input Voltage Specification

STATUS
Required

The power supply must operate within all specified limits over the following input voltage range. Harmonic distortion of up to 10% THD must not cause the power supply to go out of specified limits. The power supply shall operate properly at 85 VAC input voltage to guarantee proper design margins.

Table 3: AC Input Voltage Rating

Parameter	MIN	Rated	MAX
Voltage (110)	90 V _{rms}	100-127 V _{rms}	140 V _{rms}
Voltage (220)	180 V _{rms}	200-240 V _{rms}	264 V _{rms}
Frequency	47 Hz		63 Hz

5.3 Input Under Voltage

STATUS
Required

The power supply shall contain protection circuitry such that application of an input voltage below the minimum specified in section 5.2 shall not cause damage to the power supply.

5.4 Efficiency

STATUS
Recommended

The following efficiency requirements are provided as a recommendation to allow for proper power supply cooling when installed in a system.

Table 4 Efficiency

Power Level	Efficiency	Airflow (reference)
125W	65%	6 CFM
250W	68%	10 CFM
350W	72%	11 CFM
400W	74%	11 CFM
450W	74%	13 CFM
500W	75%	13 CFM

5.5 AC Line Dropout

STATUS
Required

An AC line dropout is defined to be when the AC input drops to 0 VAC at any phase of the AC line for any length of time. During an AC dropout of one cycle or less the power supply must meet dynamic voltage regulation requirements over the rated load. An AC line dropout of one cycle or less shall not cause any tripping of control signals or protection circuits. If the AC dropout lasts longer than one cycle, the power supply should recover and meet all turn on requirements. The power supply must meet the AC dropout requirement over rated AC voltages, frequencies, and output loading conditions. Any dropout of the AC line shall not cause damage to the power supply.

5.6 AC Line Fuse

STATUS
Required

The power supply shall incorporate one input fuse on the LINE side for input over current protection to prevent damage to the power supply and meet product safety requirements. Fuses should be slow blow type or equivalent to prevent nuisance trips. AC inrush current shall not cause the AC line fuse to blow under any conditions. All protection circuits in the power supply shall not cause the AC fuse to blow unless a component in the power supply has failed. This includes DC output load short conditions.

STATUS
Optional

Some system applications may require a second input fuse in the NEUTRAL side of the AC input. In this case two fuses would be required; one in the LINE side and one in the NEUTRAL side of the AC inlet to the power supply.

5.7 AC Inrush

STATUS
Required

The power supply must meet inrush requirements for any rated AC voltage, during turn on at any phase of AC voltage, during a single cycle AC dropout condition, during repetitive ON/OFF cycling of AC, and over the specified temperature range (T_{op}). The peak inrush current shall be less than the ratings of its critical components (including input fuse, bulk rectifiers, and surge limiting device).

STATUS
Recommended

An additional inrush current limit is recommended for some system applications that require multiple systems on a single AC circuit. AC line inrush current shall not exceed 30 A peak for one-quarter of the AC cycle, after which, the input current should be no more than the specified maximum input current from Table 3.

5.8 AC Line Transient Specification

STATUS
Recommended

AC line transient conditions shall be defined as "sag" and "surge" conditions. Sag conditions (also referred to as "brownout" conditions) will be defined as the AC line voltage dropping below nominal voltage. Surge will be defined as the AC line voltage rising above nominal voltage.

The power supply shall meet the requirements under the following AC line sag and surge conditions.

Table 5: AC Line Sag Transient Performance

Duration	Sag	Operating AC Voltage	Line Frequency	Performance Criteria
Continuous	10%	Nominal AC Voltage ranges	50/60 Hz	No loss of function or performance
0 to 1 AC cycle	100%	Nominal AC Voltage ranges	50/60 Hz	No loss of function or performance
> 1 AC cycle	>10%	Nominal AC Voltage ranges	50/60 Hz	Loss of function acceptable, self-recoverable

Table 6: AC Line Surge Transient Performance

Duration	Surge	Operating AC Voltage	Line Frequency	Performance Criteria
Continuous	10%	Nominal AC Voltages	50/60 Hz	No loss of function or performance
0 to ½ AC cycle	30%	Mid-point of nominal AC Voltages	50/60 Hz	No loss of function or performance

5.9 AC Line Fast Transient Specification

STATUS
Recommended

The power supply shall meet the EN61000-4-5 directive and any additional requirements in IEC1000-4-5:1995 and the Level 3 requirements for surge-withstand capability, with the following conditions and exceptions:

- These input transients must not cause any out-of-regulation conditions, such as overshoot and undershoot, nor must it cause any nuisance trips of any of the power supply protection circuits.
- The surge-withstand test must not produce damage to the power supply.
- The supply must meet surge-withstand test conditions under maximum and minimum DC-output load conditions.

6 DC Output Specification

6.1 Connector

STATUS
Required

6.1.1 Power Connector (125W, 250W, 350W, 400W)

The power supply uses a blind mating type connector with edge fingers (see Figure 1) to connect the power supply's output voltages and signals to a connector located in the system. The card edge pin assignments are listed in Table 7. Figure 3 shows the card edge layout for the power supply. The connector located in the system is an AMP 1364999-1 or equivalent.

Signals that can be defined as low true or high true use the following convention: *signal#* = low true. Reserved pins are reserved for future use.

Table 7: Edge Finger Pinout

Description	Pin#	Pin#	Description
-12V	1	62	PSON#
PWOK	2	61	SDA
Reserved	3	60	SCL
ACWarning	4	59	Reserved
5VSB	5	58	ReturnS
Removed pin	6	57	Reserved
Reserved	7	56	Reserved
Reserved	8	55	3.3VS
Reserved	9	54	Reserved
Reserved	10	53	Reserved
12V2	11	52	12V2
Keying notch between positions 11 and 12			
12V2	12	51	12V2
12V2	13	50	12V2
12V1	14	49	12V1
12V1	15	48	12V1
12V1	16	47	12V1
Ground	17	46	Ground
Ground	18	45	Ground
Ground	19	44	Ground
Ground	20	43	Ground
Ground	21	42	Ground
Ground	22	41	Ground
Ground	23	40	Ground
Ground	24	39	Ground
Ground	25	38	Ground
5V	26	37	5V
5V	27	36	5V
5V	28	35	5V
3.3V	29	34	3.3V
3.3V	30	33	3.3V
3.3V	31	32	3.3V

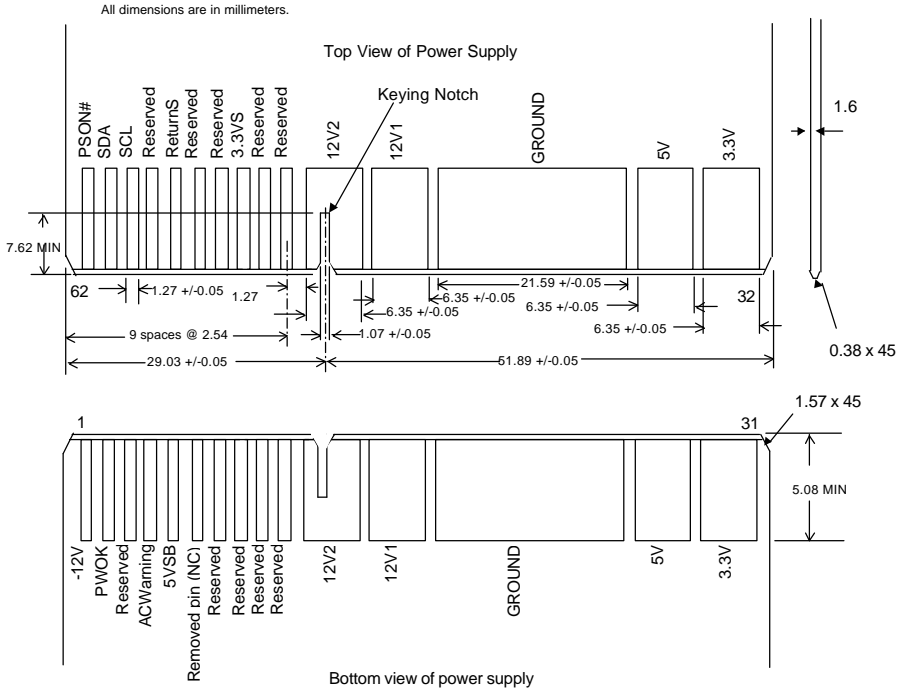

Figure 3: Edge Finger Layout

6.1.2 Power Connector (450W, 500W)

The higher power level version of the power supply uses the same connector type but a different pin assignment and keying. The card edge pin assignments are listed in Table 7. Figure 3 shows the card edge layout for the high power supply. The connector located in the system is an AMP 1364999-1 or equivalent with the keying location moved.

Signals that can be defined as low true or high true use the following convention: *signal#* = low true. Reserved pins are reserved for future use.

Table 8: Edge Finger Pinout

Description	Pin#	Pin#	Description
-12V	1	62	PSON#
PWOK	2	61	SDA
ACWarning	3	60	SCL
Removed pin	4	59	ReturnS
5VSB	5	58	3.3VS
Reserved	6	57	Reserved
Keying notch between pins 6 and 7			
12V3	7	56	12V3
12V3	8	55	12V3
12V3	9	54	12V3
12V2	10	53	12V2
12V2	11	52	12V2
12V2	12	51	12V2
12V1	13	50	12V1
12V1	14	49	12V1
12V1	15	48	12V1
Ground	16	47	Ground
Ground	17	46	Ground
Ground	18	45	Ground
Ground	19	44	Ground
Ground	20	43	Ground
Ground	21	42	Ground
Ground	22	41	Ground
Ground	23	40	Ground
Ground	24	39	Ground
Ground	25	38	Ground
5V	26	37	5V
5V	27	36	5V
5V	28	35	5V
3.3V	29	34	3.3V
3.3V	30	33	3.3V
3.3V	31	32	3.3V

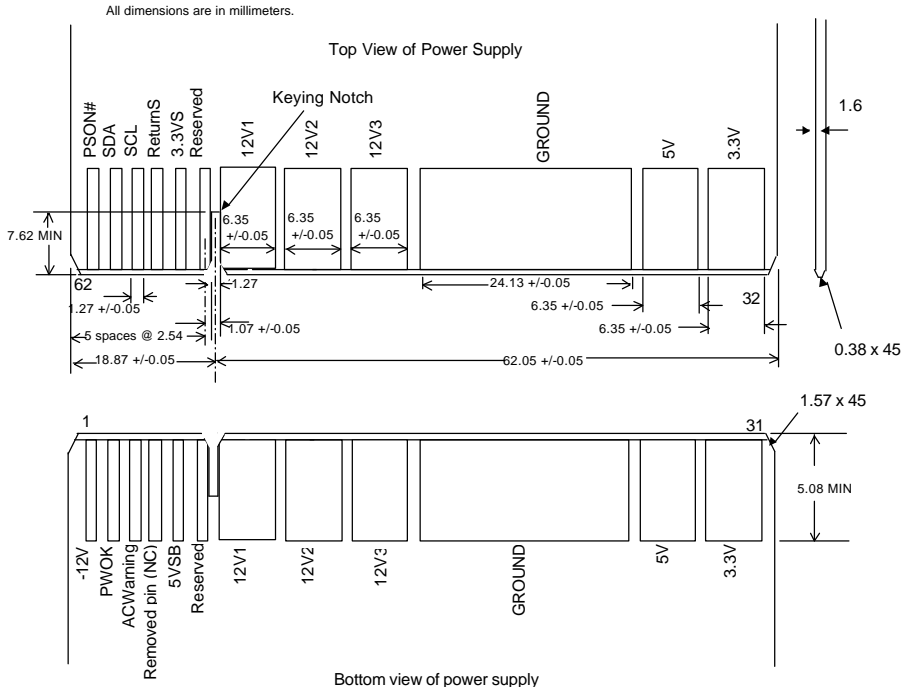

Figure 4: Edge Finger Layout

6.2 Grounding

STATUS
Required

The ground of the pins of the power supply wire harness provides the power return path. The wire harness ground pins shall be connected to safety ground (power supply enclosure).

6.3 Remote Sense

STATUS
Optional

The power supply may have remote sense return (ReturnS) to regulate out ground drops for all output voltages; +3.3 V, +5 V, +12 V1, +12 V2, -12 V, and 5 VSB. The power supply may use remote sense (3.3VS) to regulate out drops in the system for the +3.3 V output. The +5 V, +12 V1, +12 V2, -12 V, and 5 VSB outputs only use remote sense referenced to the ReturnS signal. The remote sense input impedance to the power supply must be greater than 200 Ω on 3.3 VS and ReturnS. This is the value of the resistor connecting the remote sense to the output voltage internal to the power supply. Remote sense must be able to regulate out a minimum of 200 mV drop on the +3.3 V output. The remote sense return (ReturnS) must be able to regulate out a minimum of 200 mV drop in the power ground return. The current in any remote sense line shall be less than 5 mA to prevent voltage sensing errors. The power supply must operate within specification over the full range of voltage drops from the power supply's output connector to the remote sense points.

6.4 Output Power/Currents

STATUS
Recommendations

The following tables define three power and current ratings for a 125W, 250 W and a 350 W power supply. These were selected to cover different types of systems and configurations. The 125W power level is targeted for use in "today's" low power server systems. The 250W power level is targeted for use in "today's" higher power 1U server systems. The 350W power level is directed at "tomorrow's" higher power 1U server systems. The combined output power of all outputs shall not exceed the rated output power. The tables show the load ranges for each of the two power supply power levels. The power supply must meet both static and dynamic voltage regulation requirements for the minimum loading conditions.

Table 9: 125 W Load Ratings

Load Range			
Voltage	Minimum Continuous	Maximum Continuous	Peak
+3.3 V	0.5 A	6 A	
+5 V	0.5 A	12 A	
+12 V1	0.25 A	3 A	6 A
+12 V2	Not used for 125W version.		
-12 V	0 A	0.2 A	
+5 VSB	0.1 A	1.0 A	

1. Maximum continuous total DC output power should not exceed 125 W.
2. Peak total DC output power should not exceed 161 W.
3. Peak power and current loading shall be supported for a minimum of 12 seconds.

Table 10: 250 W Load Ratings

Load Range 1			
Voltage	Minimum Continuous	Maximum Continuous	Peak
+3.3 V	1.5 A	16 A	
+5 V	1.0 A	12 A	
+12 V1	1.5 A	16 A	See note 2
+12 V2	0.5 A	10 A	See note 2
-12 V	0 A	0.5 A	
+5 VSB	0.1 A	2.0 A	

Load Range 2			
Voltage	Minimum Continuous	Maximum Continuous	Peak
+3.3 V	0.2 A	5.0 A	
+5 V	0.2 A	5.0 A	
+12 V1	0.2 A	8.0 A	
+12 V2	0.2 A	2.0 A	4.0 A
-12 V	0 A	0.5 A	
+5 VSB	0.1 A	2.0 A	

1. Maximum continuous total DC output power should not exceed 250 W.
2. Peak load on the combined 12 V output shall not exceed 22 A.
3. Maximum load on the combined 12 V output shall not exceed 18 A.
4. Peak total DC output power should not exceed 300 W.
5. Peak power and current loading shall be supported for a minimum of 12 seconds.

Table 11: 350 W Load Ratings

Load Range 1			
Voltage	Minimum Continuous	Maximum Continuous	Peak
+3.3 V	1.5 A	16 A	
+5 V	1.0 A	12 A	
+12 V1	1.5 A	18 A	22 A
+12 V2	1.5 A	16 A	
-12 V	0 A	0.5 A	
+5 VSB	0.1 A	2.0 A	

Load Range 2			
Voltage	Minimum Continuous	Maximum Continuous	Peak
+3.3 V	0.2 A	5.0 A	
+5 V	0.2 A	5.0 A	
+12 V1	0.2 A	8.0 A	11 A
+12 V2	0.2 A	5.0 A	
-12 V	0 A	0.5 A	
+5 VSB	0.1 A	2.0 A	

1. Maximum continuous total DC output power should not exceed 350 W.
2. Peak load on the combined 12 V output shall not exceed 32 A.
3. Maximum load on the combined 12 V output shall not exceed 28 A.
4. Peak total DC output power should not exceed 400 W.
5. Peak power shall be supported for a minimum of 12 seconds.
6. Peak +12 V1 current shall be supported for a minimum of 0.5 seconds.

Table 12: 400 W Load Ratings

Load Range 1			
Voltage	Minimum Continuous	Maximum Continuous	Peak
+3.3 V	1.5 A	16 A	
+5 V	1.0 A	12 A	
+12 V1	1.5 A	18 A	22 A
+12 V2	1.5 A	16 A	
-12 V	0 A	0.5 A	
+5 VSB	0.1 A	2.0 A	

Load Range 2			
Voltage	Minimum Continuous	Maximum Continuous	Peak
+3.3 V	0.2 A	5.0 A	
+5 V	0.2 A	5.0 A	
+12 V1	0.2 A	8.0 A	11 A
+12 V2	0.2 A	5.0 A	
-12 V	0 A	0.5 A	
+5 VSB	0.1 A	2.0 A	

1. Maximum continuous total DC output power should not exceed 400 W.
2. Peak load on the combined 12 V output shall not exceed 34 A.
3. Maximum load on the combined 12 V output shall not exceed 30 A.
4. Peak total DC output power should not exceed 450 W.
5. Peak power and current loading shall be supported for a minimum of 12 seconds.
6. Combined 3.3V and 5V power shall not exceed 90W.

Table 13: 450 W Load Ratings

Load Range 1			
Voltage	Minimum Continuous	Maximum Continuous	Peak
+3.3 V	1.5 A	16 A	
+5 V	1.0 A	12 A	
+12 V1	1.5 A	9 A	15 A
+12 V2	1.5 A	9 A	15 A
+12 V3	1.5 A	14 A	18 A
-12 V	0 A	0.5 A	
+5 VSB	0.1 A	2.0 A	
Load Range 2			
Voltage	Minimum Continuous	Maximum Continuous	Peak
+3.3 V	0.2 A	5.0 A	
+5 V	0.2 A	5.0 A	
+12 V1	0.2 A	4.0 A	7 A
+12 V2	0.2 A	4.0 A	7 A
+12 V3	0.2 A	5.0 A	
-12 V	0 A	0.5 A	
+5 VSB	0.1 A	2.0 A	

7. Maximum continuous total DC output power should not exceed 450 W.
8. Peak load on the combined 12 V output shall not exceed 36 A.
9. Maximum load on the combined 12 V output shall not exceed 32 A.
10. Peak total DC output power should not exceed 500 W.
11. Peak power and current loading shall be supported for a minimum of 12 seconds.
12. Combined 3.3V and 5V power shall not exceed 90W.

Table 14: 500 W Load Ratings

Load Range 1			
Voltage	Minimum Continuous	Maximum Continuous	Peak
+3.3 V	1.5 A	16 A	
+5 V	1.0 A	12 A	
+12 V1	1.5 A	11 A	15 A
+12 V2	1.5 A	11 A	15 A
+12 V3	1.5 A	14 A	18 A
-12 V	0 A	0.5 A	
+5 VSB	0.1 A	2.0 A	
Load Range 2			
Voltage	Minimum Continuous	Maximum Continuous	Peak
+3.3 V	0.2 A	5.0 A	
+5 V	0.2 A	5.0 A	
+12 V1	0.2 A	4.0 A	7 A
+12 V2	0.2 A	4.0 A	7 A
+12 V3	0.2 A	5.0 A	
-12 V	0 A	0.5 A	
+5 VSB	0.1 A	2.0 A	

13. Maximum continuous total DC output power should not exceed 500 W.
14. Peak load on the combined 12 V output shall not exceed 39 A.
15. Maximum load on the combined 12 V output shall not exceed 35 A.
16. Peak total DC output power should not exceed 550 W.
17. Peak power and current loading shall be supported for a minimum of 12 seconds.
18. Combined 3.3V and 5V power shall not exceed 90W.

6.4.1 Standby Outputs

STATUS
Required

The 5 VSB output shall be present when an AC input greater than the power supply turn on voltage is applied.

6.5 Voltage Regulation

STATUS
Required

The power supply output voltages must stay within the following voltage limits when operating at steady state and dynamic loading conditions. These limits include the peak-peak ripple/noise specified in Section 6.8. All outputs are measured with reference to the return remote sense (ReturnS) signal. The 5 V, 12 V1, 12 V2, -12 V and 5 VSB outputs are measured at the power supply connectors referenced to ReturnS. The +3.3 V is measured at its remote sense signal (3.3 VS) located at the signal connector.

Table 15: Voltage Regulation Limits

Parameter	MIN	NOM	MAX	Units	Tolerance
+3.3 V	+3.20	+3.30	+3.46	V _{rms}	+5/-3%
+5 V	+4.80	+5.00	+5.25	V _{rms}	+5/-4%
+12 V1	+11.52	+12.00	+12.60	V _{rms}	+5/-4%
+12 V2	+11.52	+12.00	+12.60	V _{rms}	+5/-4%
-12 V	-11.40	-12.20	-13.08	V _{rms}	+9/-5%
+5 VSB	+4.85	+5.00	+5.25	V _{rms}	+5/-4%

STATUS
Optional

Some system applications may require tighter regulation limits on the +5 V output. The optional regulation limits are shown below.

Table 16: Optional +5V Regulation Limits

Parameter	MIN	NOM	MAX	Units	Tolerance
+5 V	+4.85	+5.00	+5.25	V _{rms}	+5/-3%

6.6 Dynamic Loading

STATUS
Required

The output voltages shall remain within the limits specified in Table 15 for the step loading and within the limits specified in Table 17 for the capacitive loading. The load transient repetition rate shall be tested between 50 Hz and 5 kHz at duty cycles ranging from 10%-90%. The load transient repetition rate is only a test specification. The Δ step load may occur anywhere within the MIN load to the MAX load shown in Table 10 and

Table 11.

Table 17: Transient Load Requirements

Output	D Step Load Size	Load Slew Rate	Capacitive Load
+3.3 V	30% of max load	0.5 A/μs	100 μF
+5 V	30% of max load	0.5 A/μs	100 μF
12 V1	65% of max load	1 A/μs	0 μF
12 V2	65% of max load	1 A/μs	0 μF
12V 3	65% of max load	1 A/μs	0 μF
+5 VSB	25% of max load	0.5 A/μs	1 μF

6.7 Capacitive Loading

STATUS
Required

The power supply shall be stable and meet all requirements with the following capacitive loading ranges.

Table 18: Capacitive Loading Conditions

Output	MIN	MAX	Units
+3.3 V	10	6,800	μF
+5 V	10	4,700	μF
+12 V	10	11,000	μF
-12 V	1	350	μF
+5 VSB	1	350	μF

6.8 Ripple / Noise

STATUS
Required

The maximum allowed ripple/noise output of the power supply is defined in Table 19 below. This is measured over a bandwidth of 0 Hz to 20 MHz at the power supply output connectors. A 10 μF tantalum capacitor in parallel with a 0.1 μF ceramic capacitor are placed at the point of measurement.

Table 19: Ripple and Noise

+3.3 V	+5 V	+12 V	-12 V	+5 VSB
50 mVp-p	50 mVp-p	120 mVp-p	120 mVp-p	50 mVp-p

6.9 Timing Requirements

STATUS
Required

These are the timing requirements for the power supply operation. The output voltages must rise from 10% to within regulation limits ($T_{\text{vout_rise}}$) within 5 to 70 ms. The +3.3 V, +5 V and +12 V output voltages should start to rise at about the same time. All outputs must rise monotonically. The +5 V output needs to be greater than the +3.3 V output during any point of the voltage rise. The +5 V output must never be greater than the +3.3V output by more than 2.25 V. Each output voltage shall reach regulation within 50 ms ($T_{\text{vout_on}}$) of each other during turn on of the power supply. Each output voltage shall fall out of regulation within 400 ms ($T_{\text{vout_off}}$) of each other during turn off. Figure 5 and Figure 6 show the turn ON and turn OFF timing requirements. In Figure 6 the timing is shown with both AC and PSON# controlling the ON/OFF of the power supply.

Table 20: Output Voltage Timing

Item	Description	MIN	MAX	Units
$T_{\text{vout_rise}}$	Output voltage rise time from each main output.	5	70	ms
$T_{\text{vout_on}}$	All main outputs must be within regulation of each other within this time.		50	ms
$T_{\text{vout_off}}$	All main outputs must leave regulation within this time.		400	ms

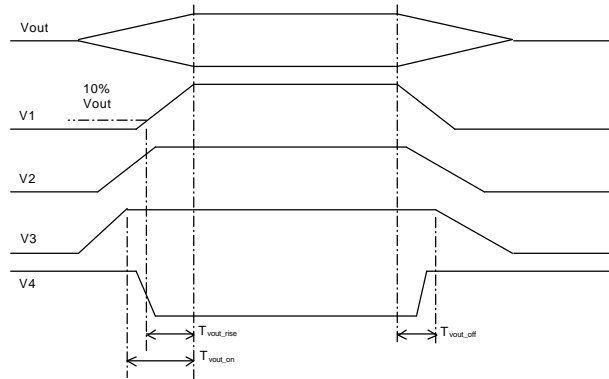

Figure 5: Output Voltage Timing

Table 21: Turn On/Off Timing

Item	Description	MIN	MAX	Units
Tsb_on_delay	Delay from AC being applied to 5 VSB being within regulation.		1500	ms
T ac_on_delay	Delay from AC being applied to all output voltages being within regulation.		2500	ms
Tvout_holdup	Time all output voltages stay within regulation after loss of AC.	18		ms
Tpwok_holdup	Delay from loss of AC to deassertion of PWOK	17		ms
Tpson_on_delay	Delay from PS0N# active to output voltages within regulation limits.	5	400	ms
T ps0n_pwok	Delay from PS0N# deactive to PWOK being deasserted.		50	ms
Tpwok_on	Delay from output voltages within regulation limits to PWOK asserted at turn on.	100	1000	ms
T pwok_off	Delay from PWOK deasserted to output voltages (3.3 V, 5 V, 12 V, -12 V) dropping out of regulation limits.	1		ms
Tpwok_low	Duration of PWOK being in the deasserted state during an off/on cycle using AC or the PS0N# signal.	100		ms
Tsb_vout	Delay from 5 VSB being in regulation to O/Ps being in regulation at AC turn on.	50	1000	ms

STATUS
Recommended

Item	Description	MIN	MAX	UNITS
Tvout_holdup	Time all output voltages stay within regulation after loss of AC.	21		ms
Tpwok_holdup	Delay from loss of AC to deassertion of PWOK.	20		ms
Tsb_holdup	Time 5VSB output voltage stays within regulation after loss of AC.	70		ms

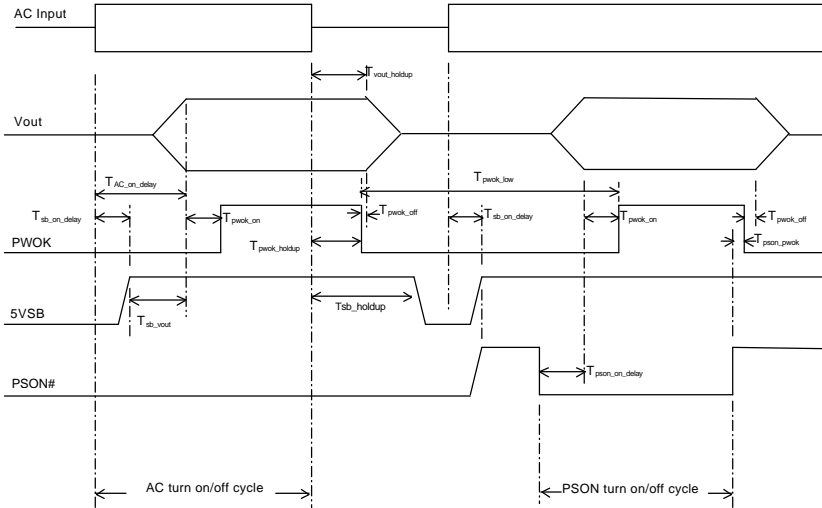

Figure 6: Turn On/Off Timing (Signal Power Supply)

7 Protection Circuits

STATUS
Required

Protection circuits inside the power supply shall cause only the power supply's main outputs to shutdown. If the power supply latches off due to a protection circuit tripping, an AC cycle OFF for 15 seconds and a PSON# cycle HIGH for 1 second shall be able to reset the power supply.

7.1 Current Limit

STATUS
Required

The power supply shall have current limit to prevent the +3.3 V, +5 V, and +12 V outputs from exceeding the values shown in Table 22. If the current limits are exceeded, the power supply shall shutdown and latch off. The latch will be cleared by toggling the PSON# signal or by an AC power interruption. The power supply shall not be damaged from repeated power cycling in this condition. -12 V and 5 VSB shall be protected under over current or shorted conditions so that no damage can occur to the power supply. All outputs shall be protected so that no damage occurs to the power supply under a shorted output condition.

Table 22: Over Current Protection

Voltage	Over Current Limit (lout limit)
+3.3 V	110% minimum; 150% maximum
+5 V	110% minimum; 150% maximum
+12 V	110% minimum; 150% maximum

7.2 240VA Protection

STATUS
Recommended

System designs may require user access to energized areas of the system. In these cases the power supply may be required to meet regulatory 240VA limits for any power rail. Since the +12V rail combined power exceeds 240VA it must be divided into separate channels to meet this requirement. Each separate rail needs to be limited to less than 20A for each +12V rail. The separate +12V rails do not necessarily need to be independently regulated outputs. They can share a common power conversion stage. The +12V rail is divided into two rails for the 250W, 350W, and 400W power levels. +12V1 is dedicated for providing power to the input of the processor voltage regulator(s). The +12V2 rail is used to power the rest of the main board +12V power needs and peripherals devices. The +12V rail is divided into three rails for the 450W and 500W power levels. The +12V1 and +12V2 rails are dedicated for providing power to the inputs of the processor voltage regulators. The +12V3 rail is used to power the rest of the main board +12V power needs and peripheral devices.

Table 23: Over Current Protection

Voltage	250W – 400W	450W – 500W
	Over Current Limit (I _{out} limit)	Over Current Limit (I _{out} limit)
+3.3 V	110% minimum; 150% maximum	110% minimum; 150% maximum
+5 V	110% minimum; 150% maximum	110% minimum; 150% maximum
+12V1	18A minimum; 20A maximum; 22A peak ¹	15A minimum; 20A maximum
+12V2	18A minimum; 20A maximum	15A minimum; 20A maximum
+12V3	Not needed on the 250W to 400W power range	18A minimum; 20A maximum

1. Peak currents shall be maintained for a minimum of 500msec. The maximum duration of the peak current exceeding the 240VA limit should be limited to meet safety regulations. A maximum duration of 1 second is recommended. This only applies to the +12V1 output for the 250W – 400W power range.

7.3 Over Voltage Protection

STATUS
Required

The power supply over voltage protection shall be locally sensed. The power supply shall shutdown and latch off after an over voltage condition occurs. This latch shall be cleared by toggling the PSON[®] signal or by an AC power interruption. Table 24 contains the over voltage limits. The values are measured at the output of the power supply's connectors. The voltage shall never exceed the maximum levels when measured at the power pins of the power supply connector during any single point of fail. The voltage shall never trip any lower than the minimum levels when measured at the power pins of the power supply connector.

Table 24: Over Voltage Limits

Output Voltage	MIN (V)	MAX (V)
+3.3 V	3.9	4.5
+5 V	5.7	6.5
+12 V1, 2	13.3	14.5
-12 V	-13.3	-14.5
+5 VSB	5.7	6.5

7.4 Over Temperature Protection

STATUS
Recommended

The power supply will be protected against over temperature conditions caused by loss of fan cooling or excessive ambient temperature. In an OTP condition the PSU will shutdown. When the power supply temperature drops to within specified limits, the power supply shall restore power automatically. The OTP circuit must have built in hysteresis such that the power supply will not oscillate on and off due to temperature recovering condition. The OTP trip level shall have a minimum of 4 °C of ambient temperature hysteresis.

8 Control and Indicator Functions

The following sections define the input and output signals from the power supply.

Signals that can be defined as low true use the following convention:

signal# = low true

8.1 PSON#

STATUS
Required

The PSON# signal is required to remotely turn on/off the power supply. PSON# is an active low signal that turns on the +3.3 V, +5 V, +12 V, and -12 V power rails. When this signal is not pulled low by the system, or left open, the outputs (except the +5 VSB and Vbias) turn off. This signal is pulled to a standby voltage by a pull-up resistor internal to the power supply. Refer to Figure 6 for the timing diagram.

Table 25: PSON# Signal Characteristic

Signal Type	Accepts an open collector/drain input from the system. Pull-up to VSB located in power supply.	
PSON# = Low	ON	
PSON# = Open or High	OFF	
	MIN	MAX
Logic level low (power supply ON)	0 V	1.0 V
Logic level high (power supply OFF)	2.0 V	5.25 V
Source current, Vpson = low		4 mA
Power up delay: $T_{pson_on_delay}$	5 ms	400 ms
PWOK delay: T_{pson_pwok}		50 ms

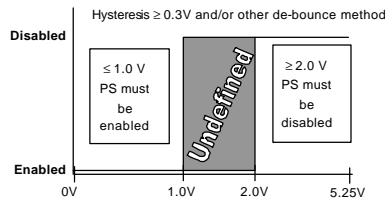

Figure 7: PSON# Signal Characteristics

8.2 PWOK (Power OK)

STATUS
Required

PWOK is a power OK signal and will be pulled HIGH by the power supply to indicate that all the outputs are within the regulation limits of the power supply. When any output voltage falls below regulation limits or when AC power has been removed for a time sufficiently long so that power supply operation is no longer guaranteed, PWOK will be de-asserted to a LOW state. See Figure 6 for a representation of the timing characteristics of PWOK. The start of the PWOK delay time shall be inhibited as long as any power supply output is in current limit.

Table 26: PWOK Signal Characteristics

Signal Type	+5V TTL Compatible output signal	
PWOK = High	Power OK	
PWOK = Low	Power not OK	
	MIN	MAX
Logic level low, Isink = 4mA		0.4 V
Logic level high, Isource = 200mA	2.4 V	5.25 V
PWOK delay: T_{pwok_on}	200 ms	1000 ms
PWOK rise and fall time		100 μ s
Power down delay: T_{pwok_off}	1 ms	

8.3 ACWarning

STATUS
Optional

This is an output signal from the power supply, which provides a warning to the system that the power supply has lost its AC input. This signal also provides a signal to synchronize the turn on of multiple power supplies. At turn on, this signal is pulled LOW when the supply's internal bulk voltage has reached a level that allows it to turn on. At turn off ACWarning goes HIGH when the internal bulk voltage drops low enough. The characteristics of the ACWarning signal are shown in [Table 27: ACWarning Signal Characteristics](#). Refer to Figure 6 for timing diagram.

Table 27: ACWarning Signal Characteristics

Signal Type	+5V TTL Compatible output signal	
ACWarning = Low	Input voltage within operating range and power supply is ready to turn on.	
ACWarning = High	Input voltage is less than the operating range and the power supply is turning off.	
	MIN	MAX
Logic level low, Isink = 4mA	0V	0.4V
Logic level high, Isource = 200mA	2.4 V	5.25V
ACWarning Delay: $T_{acwarning_delay}$	8msec	
ACWarning rise and fall time		100µsec
Power supply turn on voltage	75VAC	85VAC

8.4 Field Replacement Unit (FRU) Signals

STATUS
Optional

Two pins will be allocated for the FRU information on the power supply connector. One pin is the Serial Clock (SCL). The second pin is used for Serial Data (SDA). Both pins are bi-directional and are used to form a serial bus. The FRU circuits inside the power supply must be powered off of 5 VSB output and grounded to ReturnS (remote sense return). The Write Control (or Write protect) pin should be tied to ReturnS inside the power supply so that information can be written to the EEPROM.

8.4.1 FRU Data

FRU data shall be stored starting in address location 8000h through 80FFh. The FRU data format shall be compliant with the IPMI specifications. The current version of these specifications is available at <http://developer.intel.com/design/servers/ipmi/spec.htm>.

8.4.2 FRU Data Format

The information to be contained in the FRU device is shown in the following table.

Table 28: FRU Device Information

Area Type	Description
Common Header	As defined by the FRU document
Internal Use Area	Not required, do not reserve
Chassis Info Area	Not applicable, do not reserve
Board Info Area	Not applicable, do not reserve

8.4.2.1 Product Info Area

As defined by the IPMI FRU document. Product information shall be defined as follows:

Table 29: FRU Device Product Information Area

Field Name	Field Description
Manufacturer Name	{Formal name of manufacturer}
Product Name	{Manufacturer's model number}
Product part/model number	Customer part number
Product Version	Customer current revision
Product Serial Number	{Defined at time of manufacture}
Asset Tag	{Not used, code is zero length byte}
FRU File ID	{Not required}
PAD Bytes	{Added as necessary to allow for 8-byte offset to next area}

8.4.2.2 MultiRecord Area

As defined by the IPMI FRU document. The following record types shall be used on this power supply:

- Power Supply Information (Record Type 0x00)
- DC Output (Record Type 0x01)
- No other record types are required for the power supply.

MultiRecord information shall be defined as follows:

Table 30: FRU Device MultiRecord Area

Field Name (PS Info)	Field Information Definition
Overall Capacity (W)	350 (Low power versions would be 250 or 125)
Peak VA	400 (Low power versions would be 300 or 161)
Inrush current (A)	30
Inrush interval (ms)	5
Low end input voltage range 1	90
High end input voltage range 1	140
Low end input voltage range 2	180
High end input voltage range 2	264
A/C dropout tol. (ms)	20
Binary flags	Set for: Not Hot Swap support, Auto-switch, and PFC
Peak Wattage	Set for: 12 s, 400 W (Low power versions would be 300W or 161W)
Combined wattage	Set for 5 V & 3.3 V combined wattage of 113 W (Low power versions would be 113W or 80)
Predictive fail tach support	Not supported, 00h value
Field Name (Output)	Field Description: Six outputs are to be defined from #1 to #6, as follows: +3.3 V, +5 V, +12 V1, +12V2, -12 V, and +5 VSB.
Output Information	Set for: Standby on +5 VSB, No Standby on all others.
All other output fields	Format per IPMI specification, using parameters in the EPS1U specification.

8.5 LED Indicator

STATUS
Required

There will be a single GREEN LED to indicate power supply status. When AC is applied to the PSU and standby voltages are available the LED shall BLINK GREEN. The LED shall turn ON GREEN to indicate that all the power outputs are available. Refer to Table 31 for conditions of the LED.

Table 31: LED Indicators

Power Supply Condition	Power Supply LED
No AC power to PSU or PSU failure	OFF
AC present / Only Standby Output ON	BLINK GREEN
Power supply DC outputs ON and OK	GREEN

The LED shall be visible on the power supply's exterior face. The LED location shall meet ESD requirements. LED shall be securely mounted in such a way that incidental pressure on the LED shall not cause it to become displaced.

9 MTBF

STATUS
Recommended

The power supply shall have a minimum MTBF at continuous operation of 1) 100,000 hours at 100% load and 45° C, as calculated by Bellcore RPP, or 2) 250,000 hours demonstrated at 100% load and 45° C.

10 Agency Requirements

STATUS
Recommended

The power supply must comply with all regulatory requirements for its intended geographical market. Depending on the chosen market, regulatory requirements may vary. Although a power supply can be designed for worldwide compliance, there may be cost factors that drive different versions of supplies for different geographically targeted markets.

This specification requires that the power supply meet all regulatory requirements for the intended market at the time of manufacturing. Typically this includes:

- UL
- CSA
- A Nordic CENELEC
- TUV
- VDE
- CISPR Class B
- FCC Class B

The power supply, when installed in the system, shall meet immunity requirements specified in EN55024. Specific tests are to be EN61000-4-2, -3, -4, -5, -6, -8, and -11. The power supply must maintain normal performance within specified limits. This testing must be completed by the system EMI engineer. Conformance must be designated with the European Union CE Marking. Specific immunity level requirements are left to customer requirements.