

IC REGULATORS

Dropper Type
Switching Type
Multi Output Type

CAUTION / WARNING

- The information in this publication has been carefully checked and is believed to be accurate; however, no responsibility is assumed for inaccuracies.
- Sanken reserves the right to make changes without further notice to any products herein in the interest of improvements in the performance, reliability, or manufacturability of its products. Before placing an order, Sanken advises its customers to obtain the latest version of the relevant information to verify that the information being relied upon is current.
- Application and operation examples described in this catalog are quoted for the sole purpose of reference for the use of the products herein and Sanken can assume no responsibility for any infringement of industrial property rights, intellectual property rights or any other rights of Sanken or any third party which may result from its use.
- When using the products herein, the applicability and suitability of such products for the intended purpose or object shall be reviewed at the users' responsibility.
- Although Sanken undertakes to enhance the quality and reliability of its products, the occurrence of failure and defect of semiconductor products at a certain rate is inevitable. Users of Sanken products are requested to take, at their own risk, preventative measures including safety design of the equipment or systems against any possible injury, death, fires or damages to the society due to device failure or malfunction.
- Sanken products listed in this catalog are designed and intended for the use as components in general purpose electronic equipment or apparatus (home appliances, office equipment, telecommunication equipment, measuring equipment, etc.). Before placing an order, the user's written consent to the specifications is requested.
When considering the use of Sanken products in the applications where higher reliability is required (transportation equipment and its control systems, traffic signal control systems or equipment, fire/crime alarm systems, various safety devices, etc.), please contact your nearest Sanken sales representative to discuss and obtain written confirmation of your specifications.
The use of Sanken products without the written consent of Sanken in the applications where extremely high reliability is required (aerospace equipment, nuclear power control systems, life support systems, etc.) is strictly prohibited.
- Anti radioactive ray design is not considered for the products listed herein.
- This publication shall not be reproduced in whole or in part without prior written approval from Sanken.

Contents

Selection Guide	2
Product Index by Part Number	4
Ordering	6
Dropper Type - Application Note	7
SI-3000N Series	8
SI-3003N Series	12
SI-3001N Series	16
SI-3002N Series	20
SI-3000B Series	24
SI-3000F Series	29
SI-3000C Series	35
SI-3000J Series	42
SI-3000R Series	48
SI-3000P Series	54
SI-3000V Series	58
Switching Type - Application Note	63
SAI Series	64
SI-8000E Series	68
SI-8000S Series	72
SI-8200L/8300L Series	78
SI-8400L/8500L Series	82
SI-8800L/8900L Series	88
Multi-Output Type - Application Note	93
2-Output STA801M/802M	94
2-Output SDI02	100
3-Output SLA3001M/3002M/3004M	104
4-Output SLA3005M/3006M/3007M	110

Selection Guide

1. Dropper Type

Type	Series name	Io(A)	Vo(V)								Functions	Page	
			3.3	5	9	12	15	15.7	24	Variable output voltage (3 to 24)			
5-Terminal, Multi-Function, Low Dropout Voltage Type	SI-3000B	0.27							SI-3157B		SI-3025B	Variable output voltage (rise only) (excluding SI-3025B, SI-3025F, SI-3050R), Output ON/OFF control (excluding SI-3050R), Overcurrent/overvoltage/thermal protection, Reset (SI-3050R only)	24
	SI-3000F	1.0		SI-3050F	SI-3090F	SI-3120F	SI-3150F	SI-3157F	SI-3240F	SI-3025F	29		
	SI-3000C	1.5	SI-3033C	SI-3050C	SI-3090C	SI-3120C	SI-3150C		SI-3240C		35		
	SI-3000R	1.5		SI-3050R							48		
	SI-3000J	2.0		SI-3050J	SI-3090J	SI-3120J	SI-3150J				42		
3-Terminal, Low Dropout Voltage Type	SI-3000N	1.0		SI-3050N	SI-3090N	SI-3120N	SI-3150N				Overcurrent/ overvoltage/thermal protection	8	
	SI-3003N	1.0		SI-3053N		SI-3123N	SI-3153N					12	
	SI-3001N	1.5		SI-3051N	SI-3091N	SI-3121N	SI-3151N		SI-3241N			16	
	SI-3002N	2.0		SI-3052N	SI-3092N	SI-3122N	SI-3152N					20	
	SI-3000V	2.0		SI-3052V		SI-3122V	SI-3152V				Overcurrent protection	58	
3-Terminal Type	SI-3000P	2.0		SI-3052P		SI-3122P	SI-3152P		SI-3242P		Overcurrent protection	54	

2. Switching Type

Type	Series name	Io(A)	Vo(V)						Functions	Page
			3.3	5	9	12	15	±5		
Surface-Mount, Separate Excitation Type	SAI	0.4			SAI06	SAI03	SAI04		Overcurrent/Thermal protection, Variable output voltage (rise)	64
		0.5	SAI02	SAI01						
Separate Excitation Type	SI-8000E	0.6		SI-8050E	SI-8090E	SI-8120E		Overcurrent/Thermal protection, Variable output voltage (rise)	68	
	SI-8000S	3.0	SI-8033S	SI-8050S	SI-8090S	SI-8120S	SI-8150S	Overcurrent/Thermal protection, Soft start, Output ON/OFF control, Variable output voltage (rise)	72	
Self Oscillating Type with Coil	SI-8200L	0.28				SI-8213L			78	
		0.3		SI-8211L						
		0.35				SI-8203L				
		0.4		SI-8201L						
	SI-8300L	1.0		SI-8301L						
Separate Excitation Type with Coil	SI-8400L	0.4				SI-8402L	SI-8405L	Overcurrent/ Thermal protection	82	
		0.5	SI-8403L	SI-8401L						
	SI-8500L	1.0	SI-8503L	SI-8501L	SI-8504L	SI-8502L	SI-8505L	Overcurrent/Thermal protection Soft start, Output ON/OFF control		
Separate Excitation Type with Transformer	SI-8800L	0.45/0.05					SI-8811L	Overcurrent protection (+5V)	88	
	SI-8910L	0.3/0.1					SI-8911L	Overcurrent protection (+5V)		
	SI-8920L	0.6		SI-8921L				Overcurrent protection		
				SI-8922L						

3. Multi-Output Type

Type	Part Number	ch	Vo(V)	Io(A)	Regulator type	Functions	Page
2-Output	STA801M	ch 1	5	0.5	Switching	Overcurrent/ Thermal protection, Output ON/OFF control, Soft start	94
		ch 2	Select one from 9, 11.5, 12.1, 15.5	0.5	Switching		
	STA802M	ch 1	9	0.5	Switching		
		ch 2	Select one from 9.1, 11.7, 12.1, 15.7	0.5	Switching		
SDI02	ch 1	5	0.5	Dropper	Output ON/OFF control, Overcurrent protection (Vo shutdown after operation) Thermal protection Flag output function	100	
	ch 2	5	0.5	Dropper			
3-Output	SLA3001M	Regulator 1	12	1.5	Dropper	Variable output voltage (rise), Output ON/OFF control, Overcurrent/Overvoltage/Thermal protec- tion	104
		Regulator 2	5	1.5	Dropper		
		Regulator 3	9	1.5	Dropper		
	SLA3002M	Regulator 1	5	0.5	Switching	Overcurrent/Thermal protection	
		Regulator 2	15.7	1	Dropper	Variable output voltage (rise) , Output ON/OFF control, Overcurrent/ Overvoltage/Thermal protection	
		Regulator 3	9	0.4	Switching	Overcurrent/Thermal protection	
SLA3004M	Regulator 1	5	0.5	Switching	Overcurrent/Thermal protection		
	Regulator 2	9	0.4	Switching			
	Regulator 3	9	0.4	Switching			
4-Output	SLA3005M	ch 1	5	0.5	Dropper	Output ON/OFF control, Overcurrent protection (Vo shutdown after operation) Thermal protection Flag output function	110
		ch 2	5	0.5	Dropper		
		ch 3	5	0.5	Dropper		
		ch 4	5	0.5	Dropper		
	SLA3006M	ch 1	5	0.5	Dropper	Output ON/OFF control	
		ch 2	5	0.5	Dropper	Overcurrent protection	
		ch 3	5	0.5	Dropper	Thermal protection	
		ch 4	5	0.5	Dropper	Flag output function	
	SLA3007M	ch 1	5	0.5	Dropper	Output ON/OFF control, Overcurrent protection (Vo shutdown after operation) Thermal protection Flag output function (except ch 4)	
		ch 2	5	0.5	Dropper		
		ch 3	5	0.5	Dropper		
		ch 4	3.3	0.5	Dropper		

Product Index by Part Number

Part Number	Vo(V)	Io(A)	Regulator type	Package	Remarks	Page
SAI01	5.0	0.5	Switching	Surface-Mount		64
SAI02	3.3	0.5	Switching	Surface-Mount		64
SAI03	12.0	0.4	Switching	Surface-Mount		64
SAI04	15.0	0.4	Switching	Surface-Mount		64
SAI06	9.0	0.4	Switching	Surface-Mount		64
SDI02	5.0/5.0	0.5/Each output	Dropper	Surface-Mount	2-Output	100
SI-3025B	Variable Output Voltage	0.27	Dropper	5-Terminal Full-Mold	Low Dropout Voltage	24
SI-3025F	Variable Output Voltage	1.0	Dropper	5-Terminal Full-Mold	Low Dropout Voltage	29
SI-3033C	3.3	1.5	Dropper	5-Terminal Full-Mold	Low Dropout Voltage	35
SI-3050C	5.0	1.5	Dropper	5-Terminal Full-Mold	Low Dropout Voltage	35
SI-3050F	5.0	1.0	Dropper	5-Terminal Full-Mold	Low Dropout Voltage	29
SI-3050J	5.0	2.0	Dropper	5-Terminal Full-Mold	Low Dropout Voltage	42
SI-3050N	5.0	1.0	Dropper	3-Terminal Full-Mold	Low Dropout Voltage	8
SI-3050R	5.0	1.5	Dropper	5-Terminal Full-Mold	Built-in Reset Function, Low dropout Voltage	48
SI-3051N	5.0	1.5	Dropper	3-Terminal Full-Mold	Low Dropout Voltage	16
SI-3052N	5.0	2.0	Dropper	3-Terminal Full-Mold	Low Dropout Voltage	20
SI-3052P	5.0	2.0	Dropper	3-Terminal		55
SI-3052V	5.0	2.0	Dropper	3-Terminal	Low Dropout Voltage	59
SI-3053N	5.0	1.0	Dropper	3-Terminal Full-Mold	Low Dropout Voltage	12
SI-3090C	9.0	1.5	Dropper	5-Terminal Full-Mold	Low Dropout Voltage	35
SI-3090F	9.0	1.0	Dropper	5-Terminal Full-Mold	Low Dropout Voltage	29
SI-3090J	9.0	2.0	Dropper	5-Terminal Full-Mold	Low Dropout Voltage	42
SI-3090N	9.0	1.0	Dropper	3-Terminal Full-Mold	Low Dropout Voltage	8
SI-3091N	9.0	1.5	Dropper	3-Terminal Full-Mold	Low Dropout Voltage	16
SI-3092N	9.0	2.0	Dropper	3-Terminal Full-Mold	Low Dropout Voltage	20
SI-3120C	12.0	1.5	Dropper	5-Terminal Full-Mold	Low Dropout Voltage	35
SI-3120F	12.0	1.0	Dropper	5-Terminal Full-Mold	Low Dropout Voltage	29
SI-3120J	12.0	2.0	Dropper	5-Terminal Full-Mold	Low Dropout Voltage	42
SI-3120N	12.0	1.0	Dropper	3-Terminal Full-Mold	Low Dropout Voltage	8
SI-3121N	12.0	1.5	Dropper	3-Terminal Full-Mold	Low Dropout Voltage	16
SI-3122N	12.0	2.0	Dropper	3-Terminal Full-Mold	Low Dropout Voltage	20
SI-3122P	12.0	2.0	Dropper	3-Terminal		55
SI-3122V	12.0	2.0	Dropper	3-Terminal	Low Dropout Voltage	59
SI-3123N	12.0	1.0	Dropper	3-Terminal Full-Mold	Low Dropout Voltage	12
SI-3150C	15.0	1.5	Dropper	5-Terminal Full-Mold	Low Dropout Voltage	35
SI-3150F	15.0	1.0	Dropper	5-Terminal Full-Mold	Low Dropout Voltage	29
SI-3150J	15.0	2.0	Dropper	5-Terminal Full-Mold	Low Dropout Voltage	42
SI-3150N	15.0	1.0	Dropper	3-Terminal Full-Mold	Low Dropout Voltage	8
SI-3151N	15.0	1.5	Dropper	3-Terminal Full-Mold	Low Dropout Voltage	16
SI-3152N	15.0	2.0	Dropper	3-Terminal Full-Mold	Low Dropout Voltage	20
SI-3152P	15.0	2.0	Dropper	3-Terminal		55
SI-3152V	15.0	2.0	Dropper	3-Terminal	Low Dropout Voltage	59
SI-3153N	15.0	1.0	Dropper	3-Terminal Full-Mold	Low Dropout Voltage	12
SI-3157B	15.7	0.27	Dropper	5-Terminal Full-Mold	Low Dropout Voltage	24
SI-3157F	15.7	1.0	Dropper	5-Terminal Full-Mold	Low Dropout Voltage	29
SI-3240C	24.0	1.5	Dropper	5-Terminal Full-Mold	Low Dropout Voltage	35
SI-3241N	24.0	1.5	Dropper	3-Terminal Full-Mold	Low Dropout Voltage	16
SI-3242P	24.0	2.0	Dropper	3-Terminal		55

Part Number	V _o (V)	I _o (A)	Regulator type	Package	Remarks	Page
SI-8033S	3.3	3.0	Switching	5-Terminal Full-Mold		72
SI-8050E	5.0	0.6	Switching	5-Terminal Full-Mold		68
SI-8050S	5.0	3.0	Switching	5-Terminal Full-Mold		72
SI-8090E	9.0	0.6	Switching	5-Terminal Full-Mold		68
SI-8090S	9.0	3.0	Switching	5-Terminal Full-Mold		72
SI-8120E	12.0	0.6	Switchin	5-Terminal Full-Mold		68
SI-8120S	12.0	3.0	Switching	5-Terminal Full-Mold		72
SI-8150S	15.0	3.0	Switching	5-Terminal Full-Mold		72
SI-8201L	5.0	0.4	Switching		With Coil	78
SI-8203L	12.0	0.35	Switching		With Coil	78
SI-8211L	5.0	0.3	Switching		With Coil	78
SI-8213L	12.0	0.28	Switching		With Coi	78
SI-8301L	5.0	1.0	Switching		With Coil	78
SI-8401L	5.0	0.5	Switching		With Coil	82
SI-8402L	12.0	0.4	Switching		With Coil	82
SI-8403L	3.3	0.5	Switching		With Coil	82
SI-8405L	15.0	0.4	Switching		With Coil	82
SI-8501L	5.0	1.0	Switching		With Coil	82
SI-8502L	12.0	1.0	Switching		With Coil	82
SI-8503L	3.3	1.0	Switching		With Coil	82
SI-8504L	9.0	1.0	Switching		With Coil	82
SI-8505L	15.0	1.0	Switching		With Coil	82
SI-8811L	±5	0.45/0.05	Switching		With Transformer	88
SI-8911L	±5	0.3/0.1	Switching		With Transformer	88
SI-8921L	5.0	0.6	Switching		With Transformer	88
SI-8922L	5.0	0.6	Switching		With Transformer	88
SLA3001M	12/5/9	1.5/1.5/1.5	DR/DR/DR		3-Output	104
SLA3002M	5/15.7/9	0.5/1/0.4	SW/DR/SW		3-Output	104
SLA3004M	5/9/9	0.5/0.4/0.4	SW/SW/SW		3-Output	104
SLA3005M	5	0.5/Each Output	Dropper		4-Output	110
SLA3006M	5	0.5/Each Output	Dropper		4-Output	110
SLA3007M	5/5/5/3.3	0.5/Each Output	Dropper		4-Output	110
STA801M	ch1:5/ch2:select one from 9, 11.5, 12.1, 15.5	0.5/Each Output	Switching		2-Output	94
STA802M	ch1:9/ch2:select one from 9.1, 11.7, 12.1, 15.7	0.5/Each Output	Switching		2-Output	94

Ordering

Please specify a multiple of the standard minimum number of packages when ordering.

Series	Standard minimum number of packages
SI-3000N	100 pcs.
SI-3001N	
SI-3002N	
SI-3003N	
SI-3000B	
SI-3000F	
SI-3000C	
SI-3000J	
SI-3000R	
SI-3000P	
SI-3000V	
SI-8000E	
SI-8000S	
SI-8200L/8300L	
SI-8400L/8500L	
SI-8800L/9800L	
STA800M	
SLA3000M	
SAI	2,000 pcs. (reel)
SDI	1,200 pcs. (reel)

Dropper Type - Application Note

Temperature and Reliability

The reliability of an IC is highly dependent on its operating temperature. Design should pay particular attention to ensuring ample space for radiating heat.

Be sure to apply silicon grease to the IC before attaching a heatsink, and to secure it firmly to the heatsink.

Other important items to be considered regarding heat radiation include air convection during operation.

Calculating Internal Power Dissipation (P_D)

P_D is given by the following formula:

$$P_D = I_O \cdot [V_{IN(\text{mean})} - V_O]$$

Determine the size of the heatsink according to the relationship between allowable power dissipation and ambient temperature.

Setting DC Input Voltage

The waveform of a DC input voltage is shown below.

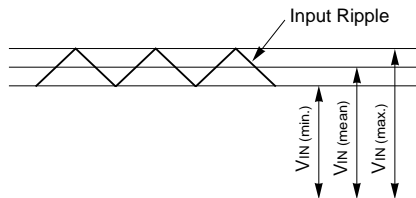

When setting the DC input voltage, pay attention to the following:

- V_{IN(min)} must be no less than the sum of output voltage and dropout voltage.
- V_{IN(max)} must be no more than the maximum rated DC input voltage.

Heatsink Design

The maximum junction temperature T_{j(max)} given in the absolute maximum ratings is specific to each product type and must be strictly observed. Thus, thermal design must consider the conditions of use which affect the maximum power dissipation P_{D(max)} and the maximum ambient temperature T_{a(max)}.

To simplify thermal design, the relationship between these two parameters has been presented in a graph, the T_a-P_D characteristic graph. Thermal design should include these steps:

1. Obtain the maximum ambient temperature T_{a(max)}.
2. Obtain the maximum power dissipation P_{D(max)}.
3. Look for the intersection point on the T_a-P_D characteristic graph and determine the size of the heatsink.

The size of the heatsink has now been obtained. However, in actual applications, a 10 to 20% derating factor is introduced. Moreover, the heat dissipation capacity of a heatsink highly depends on how it is mounted. Thus, it is recommended to measure the heatsink and case temperature in the actual operating environment.

The T_a-P_D characteristics for each product type are provided for reference purposes.

Fastening Torque

SI-3000N	} 0.588 to 0.686[N•m] (6.0 to 7.0[kgf•cm])
SI-3001N	
SI-3002N	
SI-3003N	
SI-3000B	
SI-3000F	
SI-3000C	
SI-3000J	
SI-3000R	} 0.686 to 0.882[N•m] (7.0 to 9.0[kgf•cm])
SI-3000P	
SI-3000V	

Recommended Silicone Grease

- Shin-Etsu Chemical Co., Ltd.: G746
- GE Toshiba Silicone Co., Ltd.: YG-6260
- Dow Corning Toray Silicone Co., Ltd.: SC102

Please be careful when selecting silicone grease since the oil in some grease may penetrate the product, which will result in an extremely short product life.

Others

- Devices can not be operated in parallel to increase current.
- An isolation type diode is provided from input to ground and also from output to ground. These may be destroyed if the device is reverse biased. In this case, use a diode with low V_F to protect them.

Rectifier Diodes for Power Supplies

To rectify the AC input using rectifier diodes in power supplies, use any of the SANKEN rectifier diodes shown in the following list. (Use axial type diodes in a center-tap or bridge configuration.)

Regulator Type	Diodes
SI-3000N Series	
SI-3001N Series	RM2Z(Axial Type, V _{RM} :200V, I _O :1.2A)
SI-3002N Series	RBV-402(Bridge Type, V _{RM} :200V, I _O :4.0A)
SI-3003N Series	
SI-3000B Series	AM01Z(Axial Type, V _{RM} :200V, I _O :1.0A)
SI-3000F Series	
SI-3000C Series	
SI-3000J Series	RM2Z(Axial Type, V _{RM} :200V, I _O :1.2A)
SI-3000R Series	RBV-402(Bridge Type, V _{RM} :200V, I _O :4.0A)
SI-3000P Series	
SI-3000V Series	

SI-3000N Series

3-Terminal, Full-Mold, Low Dropout Voltage Dropper Type

■Features

- Compact full-mold package (equivalent to TO220)
- Output current: 1.0A
- Low dropout voltage: $V_{DIF} \leq 1V$ (at $I_o = 1.0A$)
- Built-in foldback overcurrent, overvoltage, thermal protection circuits

■Applications

- For stabilization of the secondary stage of switching power supplies
- Electronic equipment

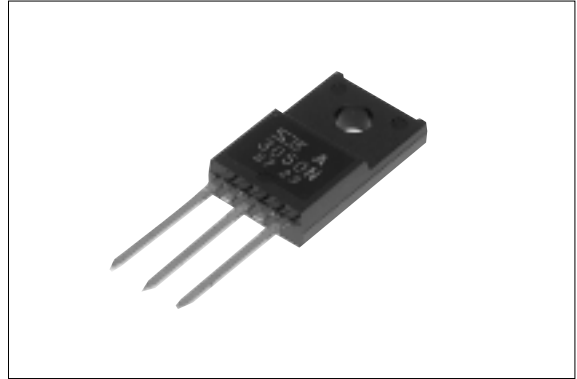

■Absolute Maximum Ratings

($T_a = 25^\circ C$)

Parameter	Symbol	Ratings			Unit
		SI-3050N	SI-3090N/3120N	SI-3150N	
DC Input Voltage	V_{IN}	25	30	35	V
DC Output Current	I_o	1.0 ²			A
Power Dissipation	P_{D1}	14(With infinite heatsink)			W
	P_{D2}	1.5(Without heatsink, stand-alone operation)			W
Junction Temperature	T_j	-40 to +125			$^\circ C$
Ambient Operating Temperature	T_{op}	-30 to +100			$^\circ C$
Storage Temperature	T_{stg}	-40 to +125			$^\circ C$
Thermal Resistance (junction to case)	$R_{th(j-c)}$	7.0			$^\circ C/W$
Thermal Resistance (junction to ambient air)	$R_{th(j-a)}$	66.7(Without heatsink, stand-alone operation)			$^\circ C/W$

■Electrical Characteristics

(Ta=25°C unless otherwise specified)

Parameter	Symbol	Ratings											Unit				
		SI-3050N			SI-3090N			SI-3120N			SI-3150N						
		min.	typ.	max.	min.	typ.	max.	min.	typ.	max.	min.	typ.		max.			
Input Voltage	V _{IN}	6 ³		15 ²	10 ³		20 ²	13 ³		25 ²	16 ³		27 ²	V			
Output Voltage	SI-3000N ^{*1}	V _O			4.80	5.00	5.20	8.64	9.00	9.36	11.52	12.00	12.48	14.40	15.00	15.60	V
	SI-3000NA	V _O			4.90	5.00	5.10	8.82	9.00	9.18	11.76	12.00	12.24	14.70	15.00	15.30	
Dropout Voltage	V _{DIF}			0.5			0.5			0.5			0.5			V	
	Conditions	V _{IN} =8V, I _O =0.5A			V _{IN} =12V, I _O =0.5A			V _{IN} =15V, I _O =0.5A			V _{IN} =18V, I _O =0.5A						
	Conditions	I _O ≤0.5A															
Line Regulation	ΔV _{OLINE}		10	30		18	48		24	64		30	90	mV			
	Conditions	V _{IN} =6 to 15V, I _O =0.5A			V _{IN} =10 to 20V, I _O =0.5A			V _{IN} =13 to 25V, I _O =0.5A			V _{IN} =16 to 27V, I _O =0.5A						
	Conditions	I _O ≤1.0A															
Load Regulation	ΔV _{OLOAD}		40	100		70	180		93	240		120	300	mV			
	Conditions	V _{IN} =8V, I _O =0 to 1.0A			V _{IN} =12V, I _O =0 to 1.0A			V _{IN} =15V, I _O =0 to 1.0A			V _{IN} =18V, I _O =0 to 1.0A						
Temperature Coefficient of Output Voltage	ΔV _O /ΔT _a		±0.5			±1.0			±1.5			±1.5		mV/°C			
	Conditions	V _{IN} =8V, I _O =5mA, T _J =0 to 100°C			V _{IN} =12V, I _O =5mA, T _J =0 to 100°C			V _{IN} =15V, I _O =5mA, T _J =0 to 100°C			V _{IN} =18V, I _O =5mA, T _J =0 to 100°C						
Ripple Rejection	R _{REJ}		54			54			54			54		dB			
	Conditions	V _{IN} =8V, f=100 to 120Hz			V _{IN} =12V, f=100 to 120Hz			V _{IN} =15V, f=100 to 120Hz			V _{IN} =18V, f=100 to 120Hz						
Quiescent Circuit Current	I _q		3	10		3	10		3	10		3	10	mA			
	Conditions	V _{IN} =8V, I _O =0A			V _{IN} =12V, I _O =0A			V _{IN} =15V, I _O =0A			V _{IN} =18V, I _O =0A						
Overcurrent Protection Starting Current ^{*4,5}	I _{S1}	1.2			1.2			1.2			1.2			A			
	Conditions	V _{IN} =8V			V _{IN} =12V			V _{IN} =15V			V _{IN} =18V						

*1: "A" may be indicated to the right of the Sanken logo.

*2: V_{IN(max)} and I_{O(max)} are restricted by the relation P_{D(max)}=(V_{IN}-V_O)•I_O=14(W).

*3: Refer to the dropout voltage.(Refer to Setting DC Input Voltage on page 7.)

*4: I_{S1} is specified at -5(%) drop point of output voltage V_O on the condition that V_{IN}=V_O+3V, I_O=0.5A.

*5: A foldback type overcurrent protection circuit is built into the IC regulator. Therefore, avoid using it for the following applications as it may cause starting errors:

- (1) Constant current load (2) Plus/minus power (3) Series power (4) V_O adjustment by raising ground voltage

■External Dimensions

(unit: mm)

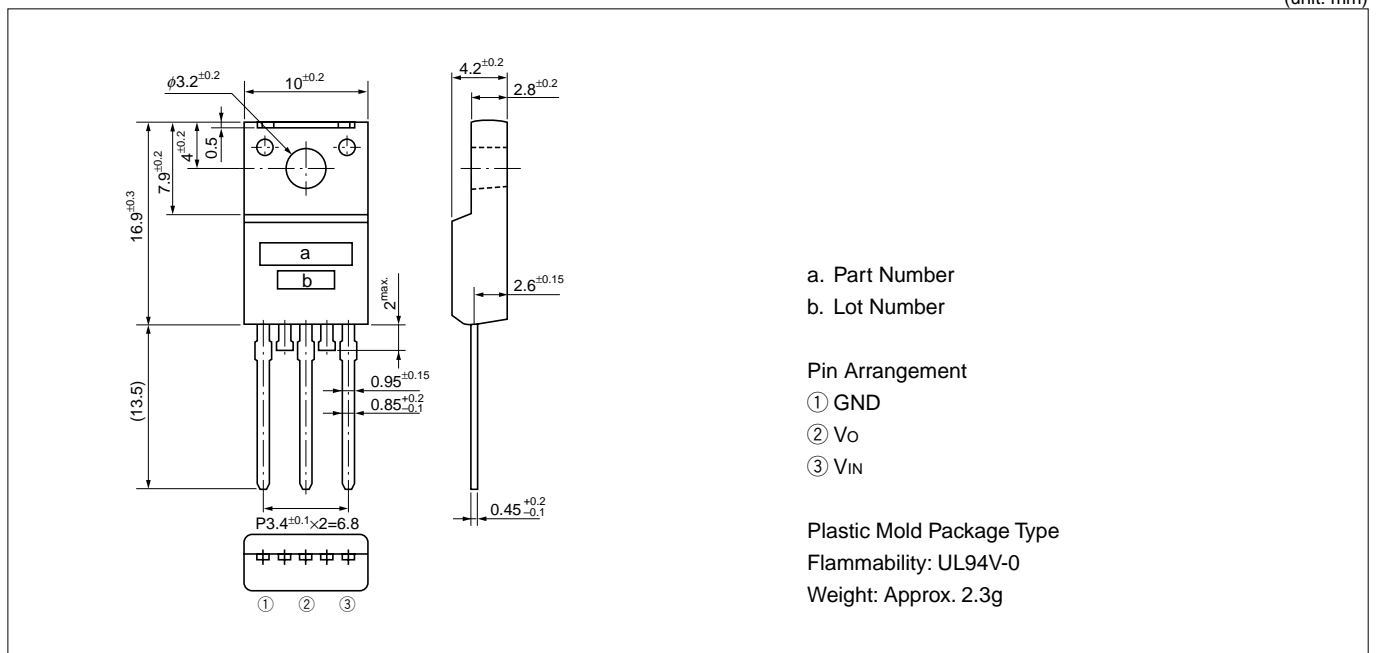

■Block Diagram

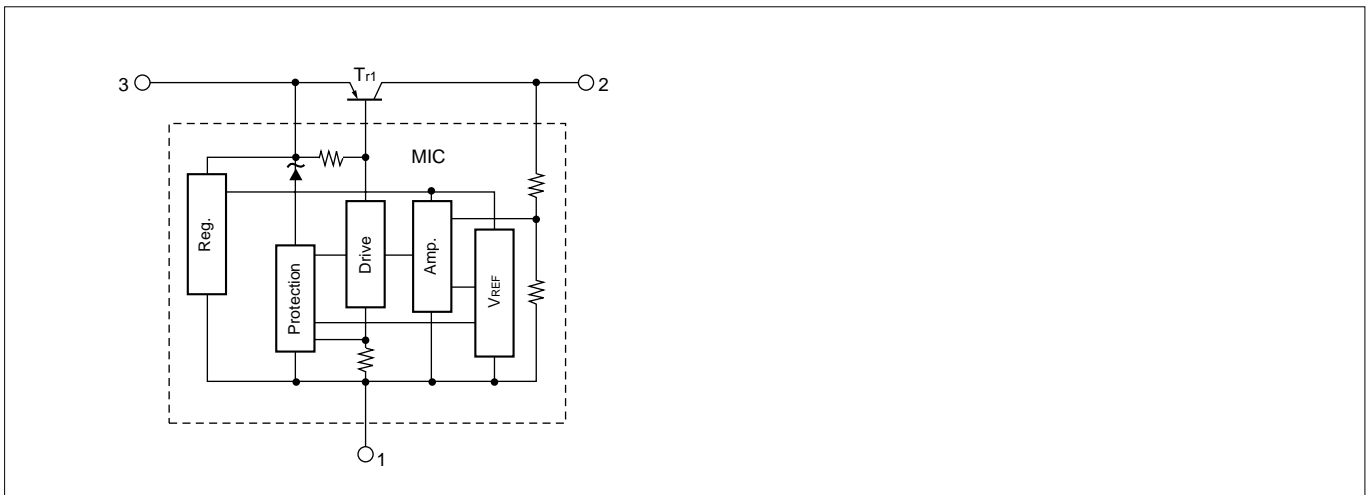

■Standard External Circuit

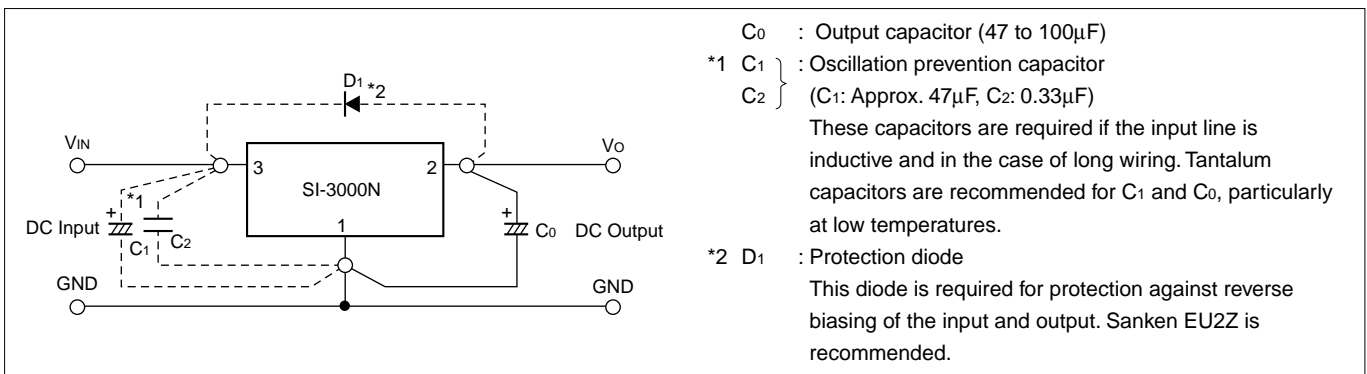

■Ta-Pd Characteristics

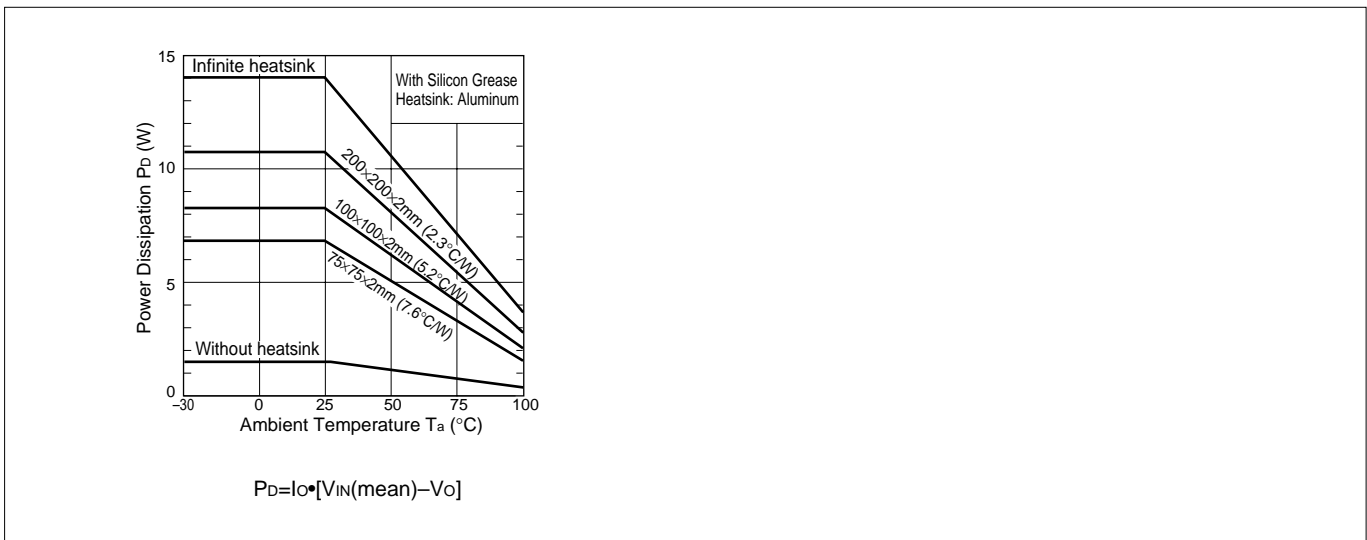

■Typical Characteristics

($T_a=25^\circ\text{C}$)

I_o vs. V_{DIF} Characteristics

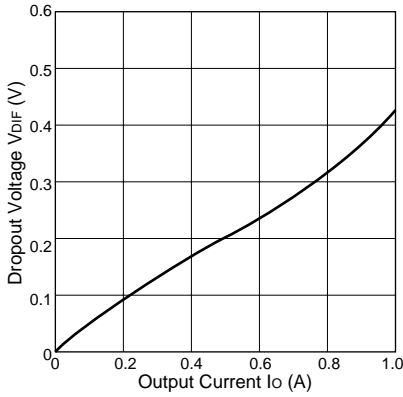

Temperature Coefficient of Output Voltage(SI-3050N)

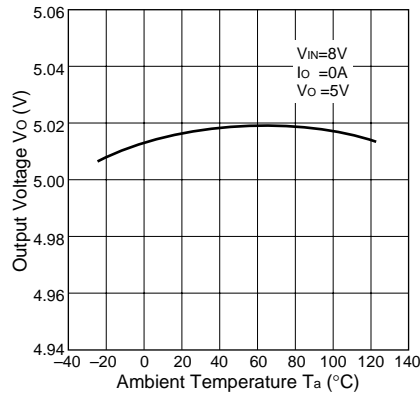

Output Voltage(SI-3050N)

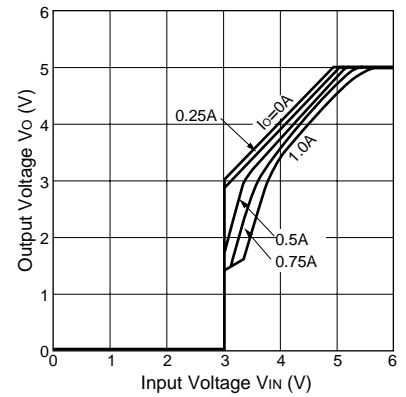

Output Voltage(SI-3120N)

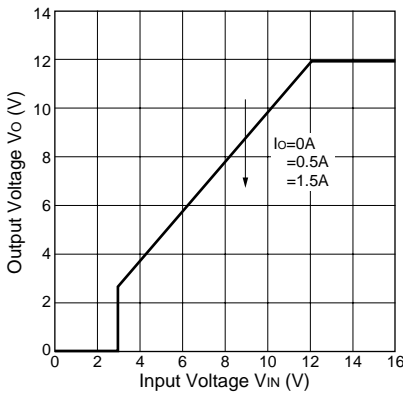

Overcurrent Protection Characteristics(SI-3050N)

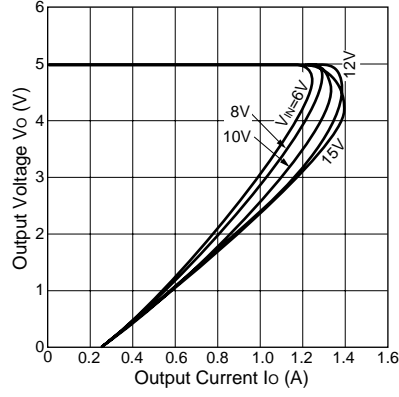

Overcurrent Protection Characteristics(SI-3120N)

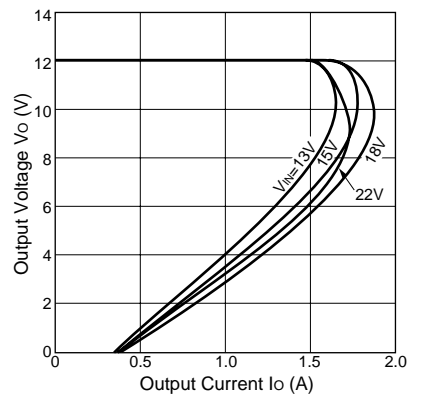

Thermal Protection Characteristics(SI-3050N)

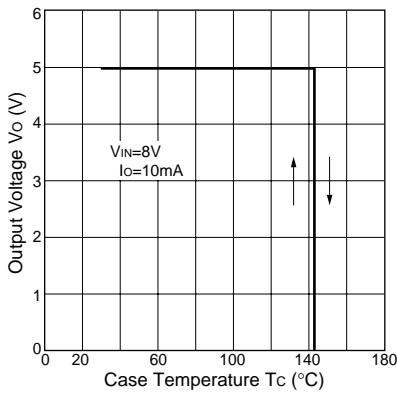

Note on Thermal Protection:

The thermal protection circuit is intended for protection against heat during instantaneous short-circuiting. Its operation is not guaranteed for continuous heating condition such as short-circuiting over extended periods of time.

SI-3003N Series

3-Terminal, Full-Mold, Low Dropout Voltage Dropper Type

■Features

- Compact full-mold package (equivalent to TO220)
- Output current: 1.0A
- Low dropout voltage: $V_{DIF} \leq 0.5V$ (at $I_o = 1.0A$)
- Built-in dropping overcurrent, overvoltage, thermal protection circuits
- Supports constant current load and plus/minus power supplies.

■Applications

- For stabilization of the secondary stage of switching power supplies
- Electronic equipment

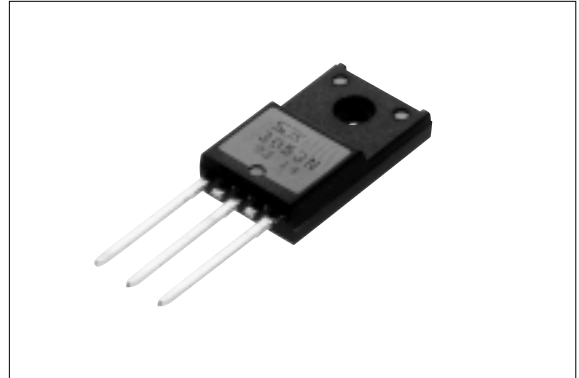

■Absolute Maximum Ratings

($T_a = 25^\circ C$)

Parameter	Symbol	Ratings			Unit
		SI-3053N	SI-3123N	SI-3153N	
DC Input Voltage	V_{IN}	25	30	30	V
DC Output Current	I_o	1.0*1			A
Power Dissipation	P_{D1}	20(With infinite heatsink)			W
	P_{D2}	1.5(Without heatsink, stand-alone operation)			W
Junction Temperature	T_j	-40 to +125			$^\circ C$
Ambient Operating Temperature	T_{op}	-30 to +100			$^\circ C$
Storage Temperature	T_{stg}	-40 to +125			$^\circ C$
Thermal Resistance (junction to case)	$R_{th(j-c)}$	5.0			$^\circ C/W$
Thermal Resistance (junction to ambient air)	$R_{th(j-a)}$	66.7(Without heatsink, stand-alone operation)			$^\circ C/W$

■Electrical Characteristics

(Ta=25°C unless otherwise specified)

Parameter	Symbol	Ratings									Unit
		SI-3053N			SI-3123N			SI-3153N			
		min.	typ.	max.	min.	typ.	max.	min.	typ.	max.	
Input Voltage	V _{IN}	6 ^{*2}		15 ^{*1}	13 ^{*2}		22 ^{*1}	16 ^{*2}		25 ^{*1}	V
Output Voltage	V _O	4.90	5.00	5.10	11.76	12.00	12.24	14.70	15.00	15.30	V
	Conditions	V _{IN} =8V, I _O =1.0A			V _{IN} =15V, I _O =1.0A			V _{IN} =18V, I _O =1.0A			
Dropout Voltage	V _{DIF}			0.5			0.5			0.5	V
	Conditions	I _O ≤1.0A									
Line Regulation	ΔV _{OLINE}		10	30		24	64		30	90	mV
	Conditions	V _{IN} =6V to 15V, I _O =1.0A			V _{IN} =13V to 22V, I _O =1.0A			V _{IN} =16V to 25V, I _O =1.0A			
Load Regulation	ΔV _{OLOAD}		20	50		40	120		50	150	mV
	Conditions	V _{IN} =8V, I _O =0 to 1.0A			V _{IN} =15V, I _O =0 to 1.0A			V _{IN} =18V, I _O =0 to 1.0A			
Temperature Coefficient of Output Voltage	ΔV _O /ΔT _a		±0.5			±1.5			±1.5		mV/°C
	Conditions	V _{IN} =8V, I _O =5mA, T _J =0 to 100°C			V _{IN} =15V, I _O =5mA, T _J =0 to 100°C			V _{IN} =18V, I _O =5mA, T _J =0 to 100°C			
Ripple Rejection	R _{REJ}		54			54			54		dB
	Conditions	V _{IN} =8V, f=100 to 120Hz			V _{IN} =15V, f=100 to 120Hz			V _{IN} =18V, f=100 to 120Hz			
Quiescent Circuit Current	I _q		3	10		3	10		3	10	mA
	Conditions	V _{IN} =8V, I _O =0A			V _{IN} =15V, I _O =0A			V _{IN} =18V, I _O =0A			
Overcurrent Protection Starting Current ^{*4,5}	I _{s1}	1.2			1.2			1.2			A
	Conditions	V _{IN} =8V			V _{IN} =15V			V _{IN} =18V			
Limited Current at Overcurrent Protection	I _{s2}	1.2			1.2			1.2			A
	Conditions	V _{IN} =8V, V _O =0A			V _{IN} =15V, V _O =0A			V _{IN} =18V, V _O =0A			

*1: V_{IN(max)} and I_{O(max)} are restricted by the relation P_{D(max)}=(V_{IN}-V_O)•I_O=20(W).

*2: Refer to the dropout voltage.(Refer to Setting DC Input Voltage on page 7.)

*3: I_{s1} is specified at -5(%) drop point of output voltage V_O on the condition that V_{IN}=V_O+3V, I_O=1A.

■External Dimensions

(unit:mm)

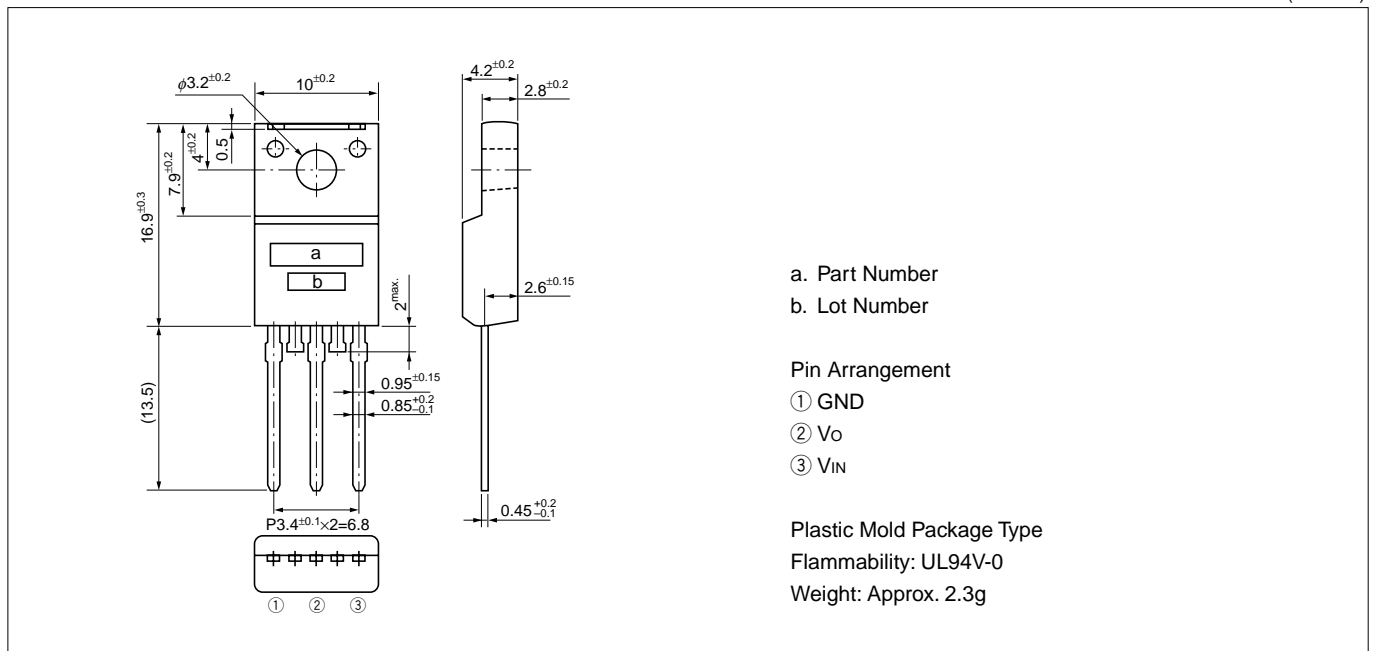

■Block Diagram

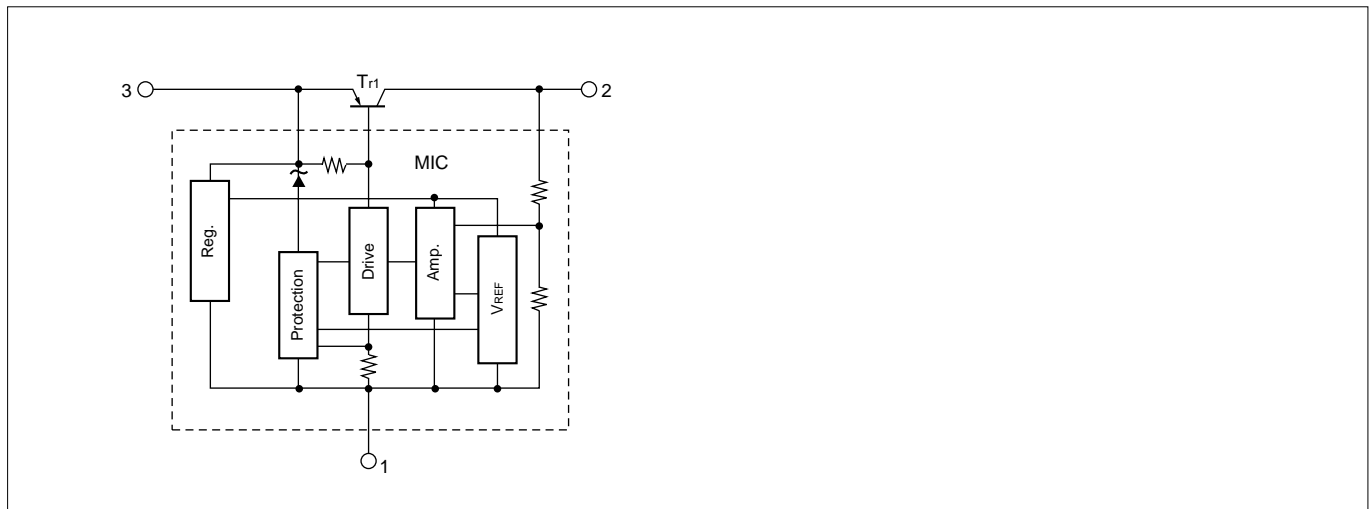

■Standard External Circuit

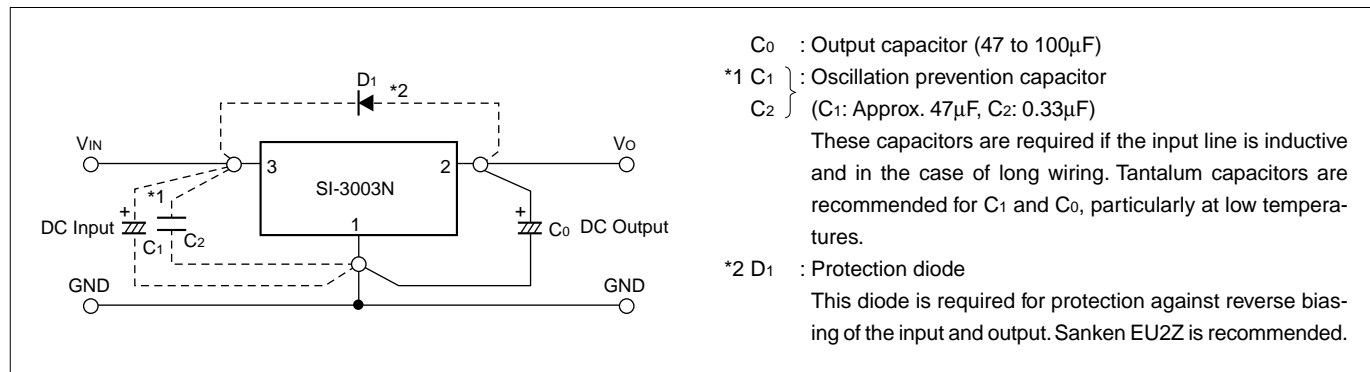

■ T_a - P_D Characteristics

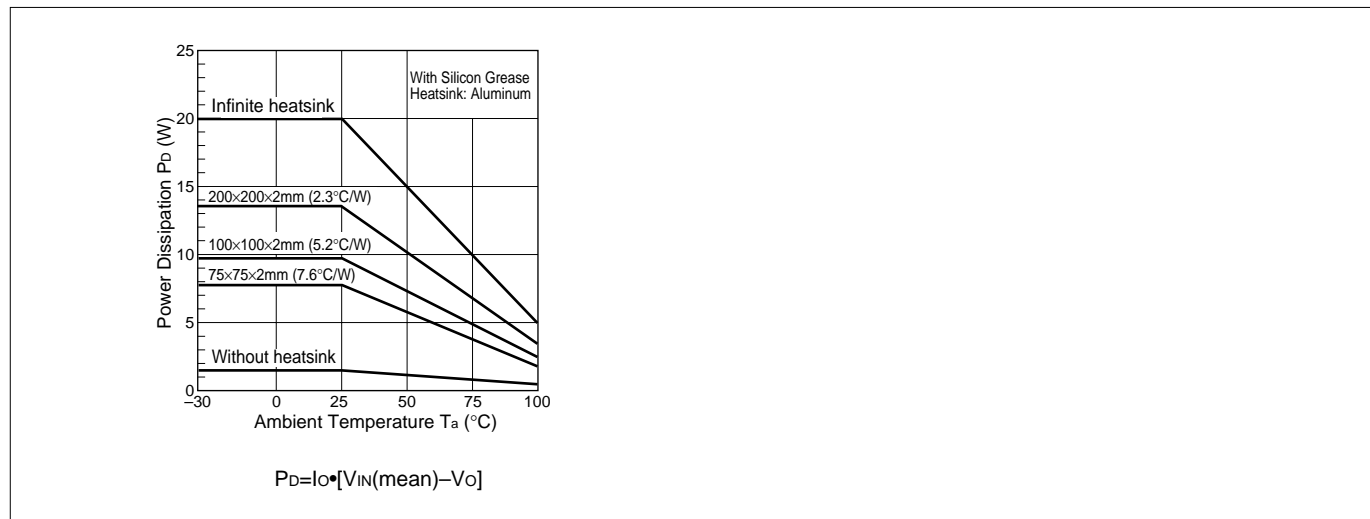

■Typical Characteristics

($T_a=25^\circ\text{C}$)

I_o vs. V_{DIF} Characteristics

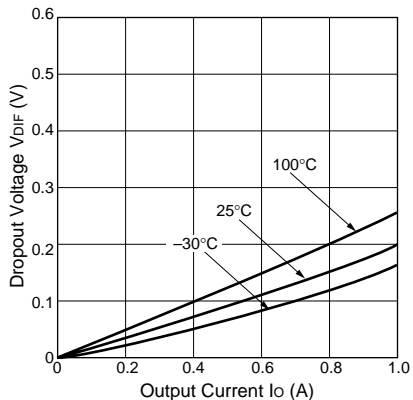

Output Voltage(SI-3053N)

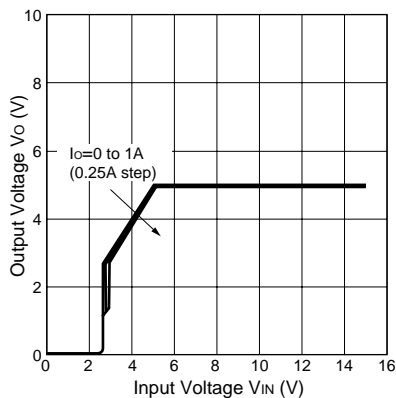

Output Voltage(SI-3123N)

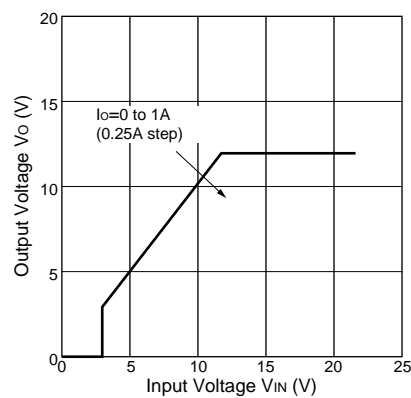

Output Voltage(SI-3153N)

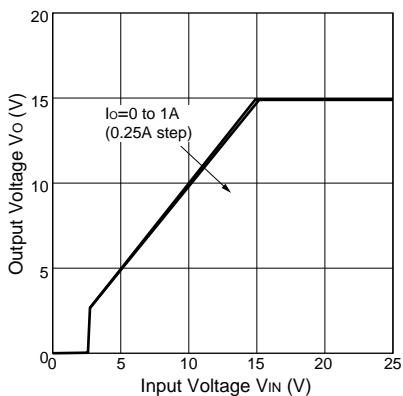

Overcurrent Protection Characteristics(SI-3053N)

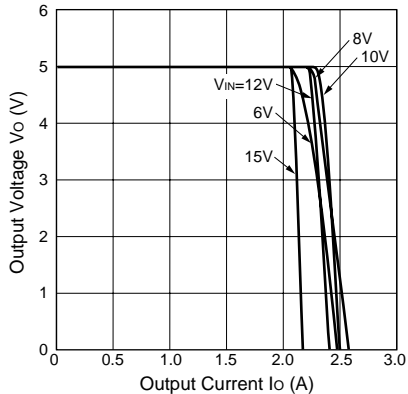

Overcurrent Protection Characteristics(SI-3123N)

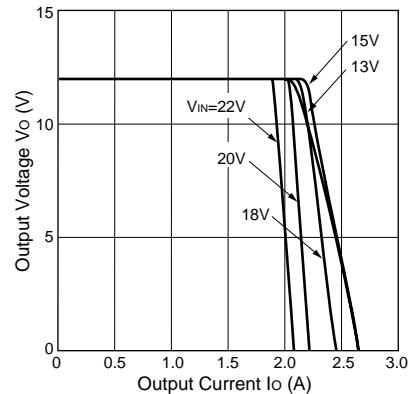

Overcurrent Protection Characteristics(SI-3153N)

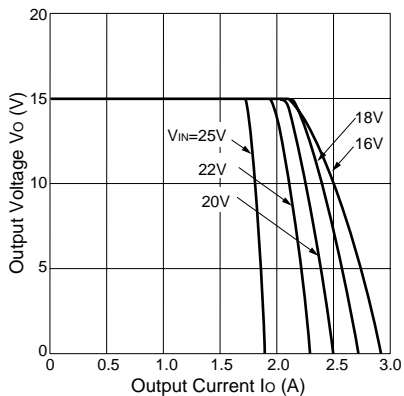

Thermal Protection Characteristics(SI-3053N)

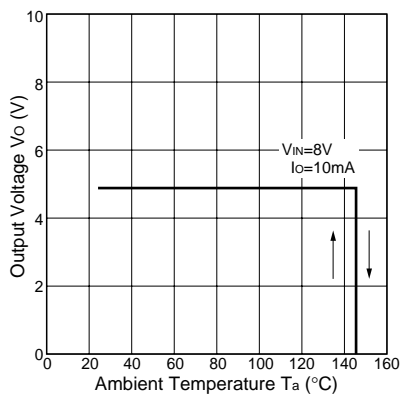

Note on Thermal Protection:

The thermal protection circuit is intended for protection against heat during instantaneous short-circuiting. Its operation is not guaranteed for continuous heating condition such as short-circuiting over extended periods of time.

SI-3001N Series

3-Terminal, Full-Mold, Low Dropout Voltage Dropper Type

■Features

- Compact full-mold package (equivalent to TO220)
- Output current: 1.5A
- Low dropout voltage: $V_{DIF} \leq 1V$ (at $I_o = 1.5A$)
- Built-in foldback overcurrent, overvoltage, thermal protection circuits

■Applications

- For stabilization of the secondary stage of switching power supplies
- Electronic equipment

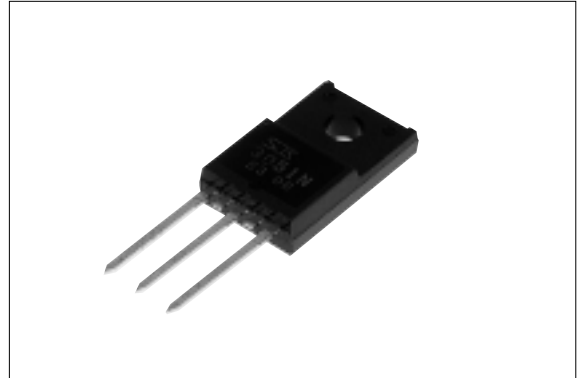

■Absolute Maximum Ratings

($T_a = 25^\circ C$)

Parameter	Symbol	Ratings			Unit
		SI-3051N/3091N	SI-3121N/3151N	SI-3241N	
DC Input Voltage	V_{IN}	35	35	45	V
DC Output Current	I_o	1.5 ²			A
Power Dissipation	P_{D1}	18(With infinite heatsink)			W
	P_{D2}	1.5(Without heatsink, stand-alone operation)			W
Junction Temperature	T_j	-40 to +125			$^\circ C$
Ambient Operating Temperature	T_{op}	-30 to +100			$^\circ C$
Storage Temperature	T_{stg}	-40 to +125			$^\circ C$
Thermal Resistance (junction to case)	$R_{th(j-c)}$	5.5			$^\circ C/W$
Thermal Resistance (junction to ambient air)	$R_{th(j-a)}$	66.7(Without heatsink, stand-alone operation)			$^\circ C/W$

■Electrical Characteristics

(Ta=25°C unless otherwise specified)

Parameter	Symbol	Ratings														Unit	
		SI-3051N			SI-3091N			SI-3121N			SI-3151N			SI-3241N			
		min.	typ.	max.	min.	typ.	max.	min.	typ.	max.	min.	typ.	max.	min.	typ.		max.
Input Voltage	V _{IN}	6 ³		30 ²	10 ³		30 ²	13 ³		30 ²	16 ³		30 ²	25 ³		40 ²	V
Output Voltage	SI-3001N *1	4.80	5.00	5.20	8.64	9.00	9.36	11.52	12.00	12.48	14.40	15.00	15.60	23.04	24.00	24.96	V
	SI-3001NA	4.90	5.00	5.10	8.82	9.00	9.18	11.76	12.00	12.24	14.70	15.00	15.30	23.52	24.00	24.48	
Dropout Voltage	V _{DIF}			0.5			0.5			0.5			0.5			0.5	V
	Conditions	V _{IN} =8V, I _O =1.0A			V _{IN} =12V, I _O =1.0A			V _{IN} =15V, I _O =1.0A			V _{IN} =18V, I _O =1.0A			V _{IN} =27V, I _O =1.0A			
	Conditions	I _O ≤1.0A															
Line Regulation	ΔV _{OLINE}		10	30		18	48		24	64		30	90		48	128	mV
	Conditions	V _{IN} =6V to 15V, I _O =1.0A			V _{IN} =10V to 20V, I _O =1.0A			V _{IN} =13V to 25V, I _O =1.0A			V _{IN} =16V to 27V, I _O =1.0A			V _{IN} =25V to 38V, I _O =1.0A			
	Conditions	I _O ≤1.5A															
Load Regulation	ΔV _{OLOAD}		40	100		70	180		93	240		120	300		120	300	mV
	Conditions	V _{IN} =8V, I _O =0 to 1.5A			V _{IN} =12V, I _O =0 to 1.5A			V _{IN} =15V, I _O =0 to 1.5A			V _{IN} =18V, I _O =0 to 1.5A			V _{IN} =27V, I _O =0 to 1.5A			
Temperature Coefficient of Output Voltage	ΔV _O /ΔT _a		±0.5			±1.0			±1.5			±1.5			±2.5		mV/°C
	Conditions	V _{IN} =8V, I _O =5mA, T _i =0 to 100°C			V _{IN} =12V, I _O =5mA, T _i =0 to 100°C			V _{IN} =15V, I _O =5mA, T _i =0 to 100°C			V _{IN} =18V, I _O =5mA, T _i =0 to 100°C			V _{IN} =27V, I _O =5mA, T _i =0 to 100°C			
Ripple Rejection	R _{REJ}		54			54			54			54			54		dB
	Conditions	V _{IN} =8V, f=100 to 120Hz			V _{IN} =12V, f=100 to 120Hz			V _{IN} =15V, f=100 to 120Hz			V _{IN} =18V, f=100 to 120Hz			V _{IN} =27V, f=100 to 120Hz			
Quiescent Circuit Current	I _q		5	10		5	10		5	10		5	10		5	10	mA
	Conditions	V _{IN} =8V, I _O =0A			V _{IN} =12V, I _O =0A			V _{IN} =15V, I _O =0A			V _{IN} =18V, I _O =0A			V _{IN} =27V, I _O =0A			
Overcurrent Protection Starting Current ^{4,5}	I _{S1}	1.6			1.6			1.6			1.6			1.6			A
	Conditions	V _{IN} =8V			V _{IN} =12V			V _{IN} =15V			V _{IN} =18V			V _{IN} =27V			

*1: "A" may be indicated to the right of the Sanken logo.

*2: V_{IN(max)} and I_{O(max)} are restricted by the relation P_{D(max)}=(V_{IN}-V_O)•I_O=18(W).

*3: Refer to the dropout voltage.(Refer to Setting DC Input Voltage on page 7.)

*4: I_{S1} is specified at -5(%) drop point of output voltage V_O on the condition that V_{IN}=V_O+3V, I_O=1A.

*5: A foldback type overcurrent protection circuit is built into the IC regulator. Therefore, avoid using it for the following applications as it may cause starting errors:

- (1) Constant current load (2) Plus/minus power (3) Series power (4) V_O adjustment by raising ground voltage

■External Dimensions

(unit:mm)

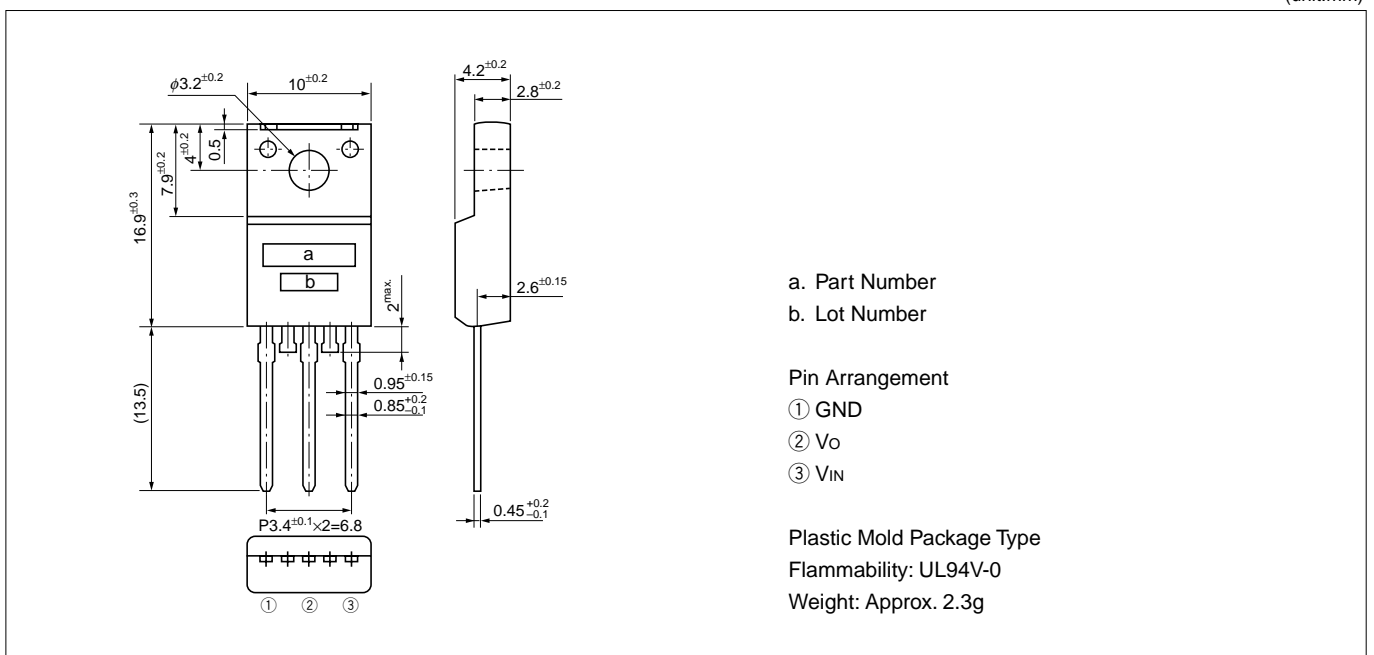

■Block Diagram

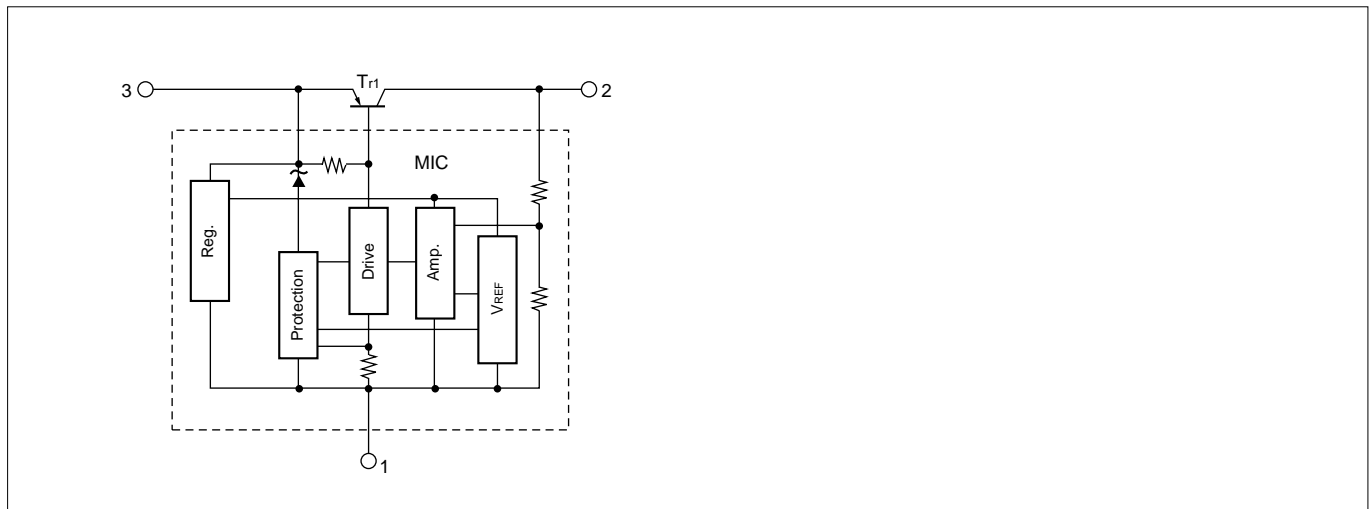

■Standard External Circuit

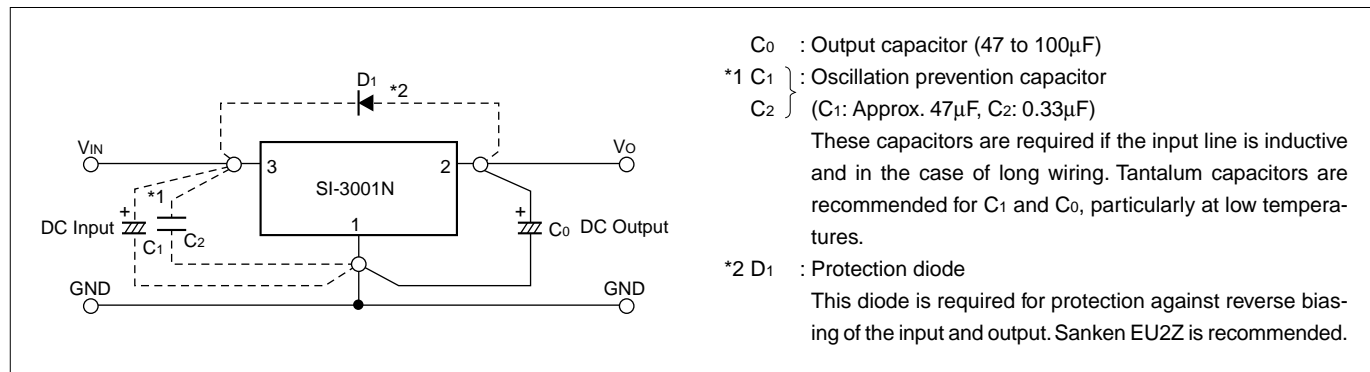

■Ta-Pd Characteristics

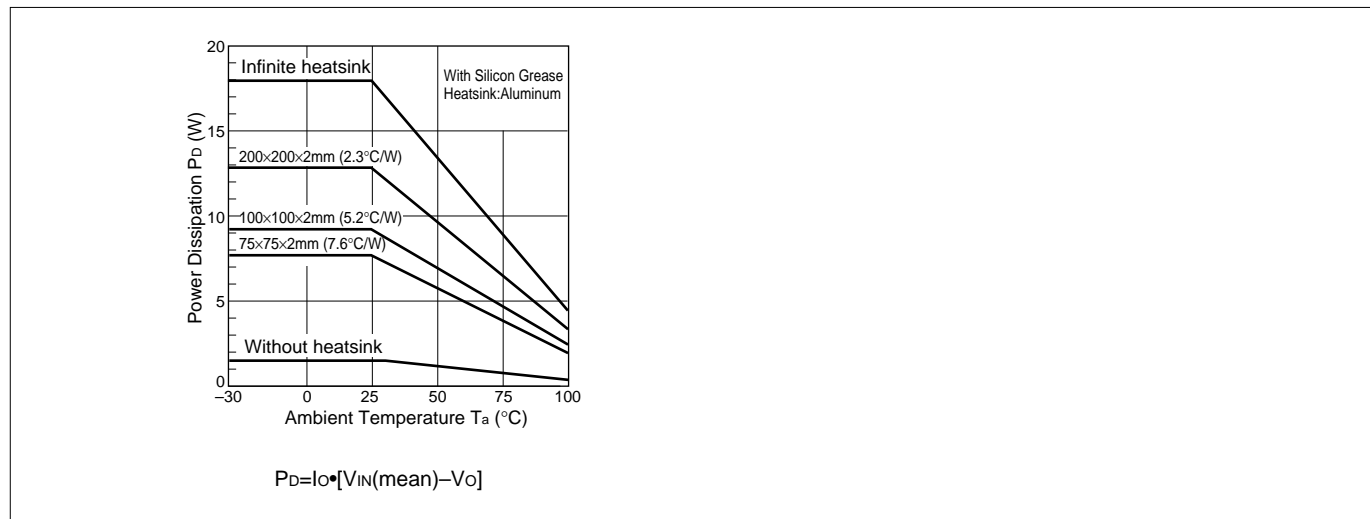

■Typical Characteristics

($T_a=25^\circ\text{C}$)

Io vs. VdIF Characteristics

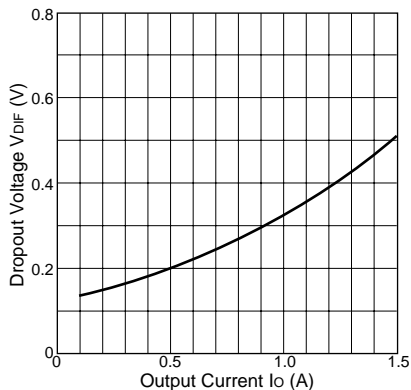

Temperature Coefficient of Output Voltage(SI-3051N)

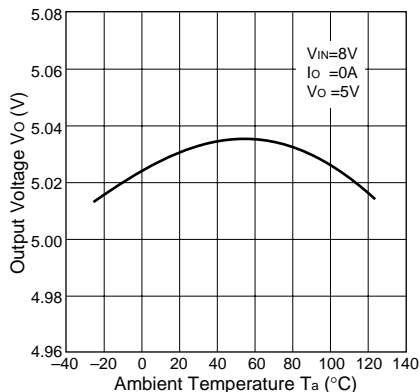

Circuit Current(SI-3051N)

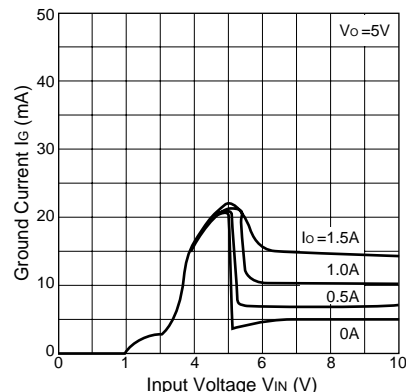

Output Voltage(SI-3051N)

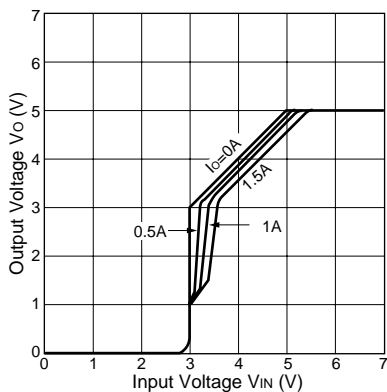

Output Voltage(SI-3121N)

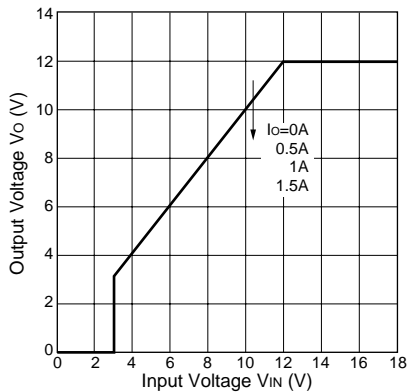

Output Voltage(SI-3241N)

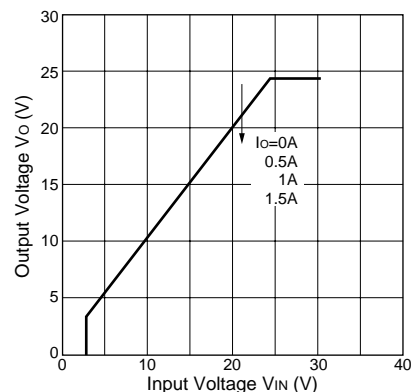

Overcurrent Protection Characteristics(SI-3051N)

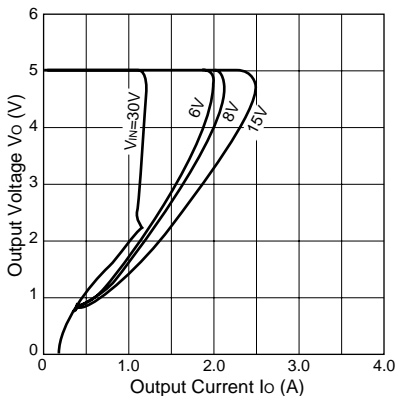

Overcurrent Protection Characteristics(SI-3121N)

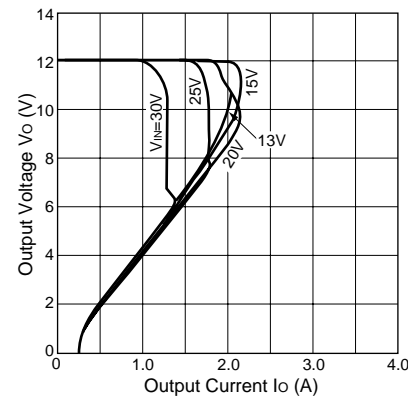

Overcurrent Protection Characteristics(SI-3241N)

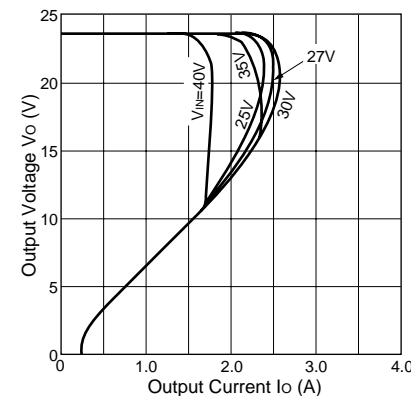

Thermal Protection Characteristics(SI-3051N)

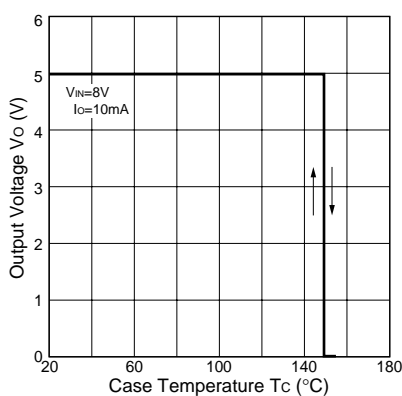

Note on Thermal Protection:
 The thermal protection circuit is intended for protection against heat during instantaneous short-circuiting. Its operation is not guaranteed for continuous heating condition such as short-circuiting over extended periods of time.

SI-3002N Series

3-Terminal, Full-Mold, Low Dropout Voltage Dropper Type

■Features

- Compact full-mold package (equivalent to TO220)
- Output current: 2.0A
- Low dropout voltage: $V_{DIF} \leq 1V$ (at $I_o = 2.0A$)
- Built-in foldback overcurrent, overvoltage, thermal protection circuits

■Applications

- For stabilization of the secondary stage of switching power supplies
- Electronic equipment

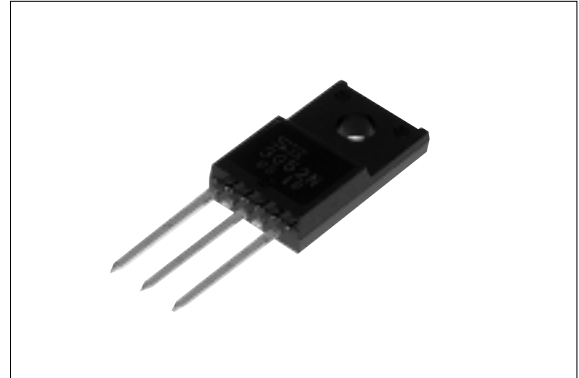

■Absolute Maximum Ratings

($T_a = 25^\circ C$)

Parameter	Symbol	Ratings			Unit
		SI-3052N	SI-3092N	SI-3122N/3152N	
DC Input Voltage	V_{IN}	25	30	35	V
DC Output Current	I_o	2.0 ¹			A
Power Dissipation	P_{D1}	20(With infinite heatsink)			W
	P_{D2}	1.5(Without heatsink, stand-alone operation)			W
Junction Temperature	T_j	-40 to +125			$^\circ C$
Ambient Operating Temperature	T_{op}	-30 to +100			$^\circ C$
Storage Temperature	T_{stg}	-40 to +125			$^\circ C$
Thermal Resistance (junction to case)	$R_{th(j-c)}$	5.0			$^\circ C/W$
Thermal Resistance (junction to ambient air)	$R_{th(j-a)}$	66.7(Without heatsink, stand-alone operation)			$^\circ C/W$

■Electrical Characteristics

(Ta=25°C unless otherwise specified)

Parameter	Symbol	Ratings											Unit	
		SI-3052N			SI-3092N			SI-3122N			SI-3152N			
		min.	typ.	max.	min.	typ.	max.	min.	typ.	max.	min.	typ.		max.
Input Voltage	V _{IN}	6 ²		15 ¹	10 ²		25 ¹	13 ²		27 ¹	16 ²		27 ¹	V
Output Voltage	V _O	4.90	5.00	5.10	8.82	9.00	9.18	11.76	12.00	12.24	14.70	15.00	15.30	V
	Conditions	V _{IN} =8V, I _O =1.0A			V _{IN} =12V, I _O =1.0A			V _{IN} =15V, I _O =1.0A			V _{IN} =18V, I _O =1.0A			
Dropout Voltage	V _{DIF}			0.5			0.5			0.5			0.5	V
	Conditions	I _O ≤1.5A												
	Conditions			1.0			1.0			1.0			1.0	
Line Regulation	ΔV _{OLINE}		10	30		18	48		24	64		30	90	mV
	Conditions	V _{IN} =6 to 15V, I _O =1.0A			V _{IN} =10 to 20V, I _O =1.0A			V _{IN} =13 to 25V, I _O =1.0A			V _{IN} =16 to 25V, I _O =1.0A			
Load Regulation	ΔV _{OLOAD}		40	100		70	180		93	240		120	300	mV
	Conditions	V _{IN} =8V, I _O =0 to 2.0A			V _{IN} =12V, I _O =0 to 2.0A			V _{IN} =15V, I _O =0 to 2.0A			V _{IN} =18V, I _O =0 to 2.0A			
Temperature Coefficient of Output Voltage	ΔV _O /ΔT _a		±0.5			±1.0			±1.5			±1.5		mV/°C
	Conditions	V _{IN} =8V, I _O =5mA, T _J =0 to 100°C			V _{IN} =12V, I _O =5mA, T _J =0 to 100°C			V _{IN} =15V, I _O =5mA, T _J =0 to 100°C			V _{IN} =18V, I _O =5mA, T _J =0 to 100°C			
Ripple Rejection	R _{REJ}		54			54			54			54		dB
	Conditions	V _{IN} =8V, f=100 to 120Hz			V _{IN} =12V, f=100 to 120Hz			V _{IN} =15V, f=100 to 120Hz			V _{IN} =18V, f=100 to 120Hz			
Quiescent Circuit Current	I _q		3	10		3	10		3	10		3	10	mA
	Conditions	V _{IN} =8V, I _O =0A			V _{IN} =12V, I _O =0A			V _{IN} =15V, I _O =0A			V _{IN} =18V, I _O =0A			
Overcurrent Protection Starting Current ^{*3,4}	I _{S1}	2.1			2.1			2.1			2.1			A
	Conditions	V _{IN} =8V			V _{IN} =12V			V _{IN} =15V			V _{IN} =18V			

*1: V_{IN(max)} and I_{O(max)} are restricted by the relation P_{D(max)}=(V_{IN}-V_O)•I_O=20(W).

*2: Refer to the dropout voltage.(Refer to Setting DC Input Voltage on page 7.)

*3: I_{S1} is specified at -5(%) drop point of output voltage V_O on the condition that V_{IN}=V_O+3V, I_O=1.0A.

*4: A foldback type overcurrent protection circuit is built into the IC regulator. Therefore, avoid using it for the following applications as it may cause starting errors:

- (1) Constant current load (2) Plus/minus power (3) Series power (4)V_O adjustment by raising ground voltage

■External Dimensions

(unit:mm)

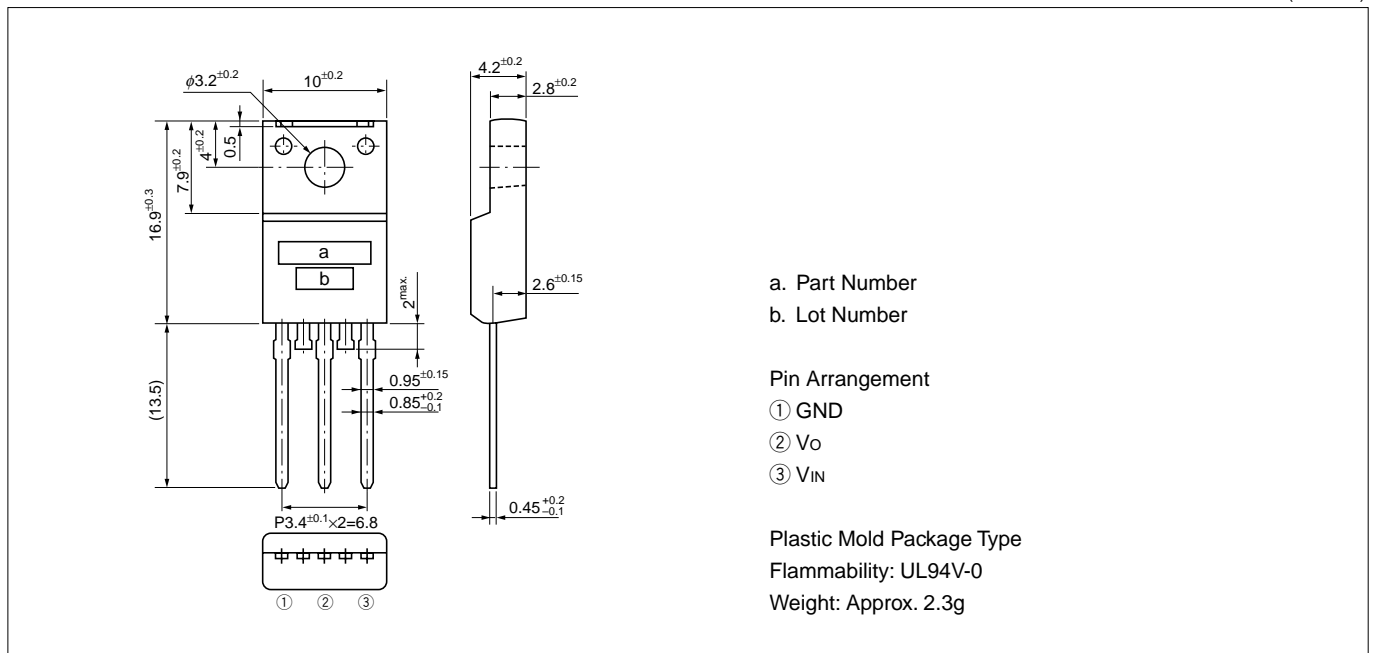

■Block Diagram

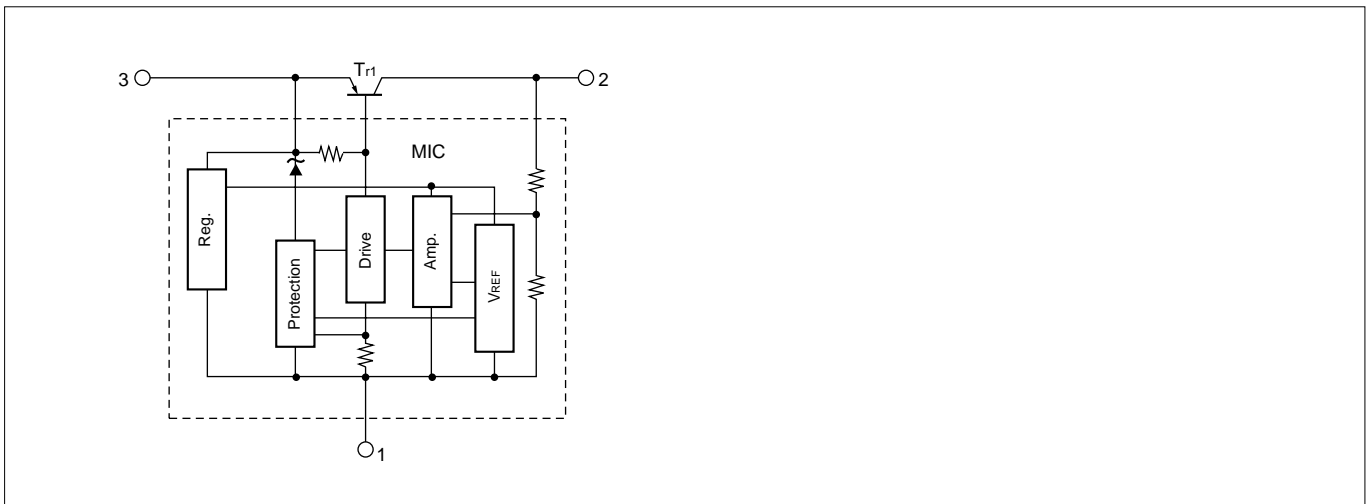

■Standard External Circuit

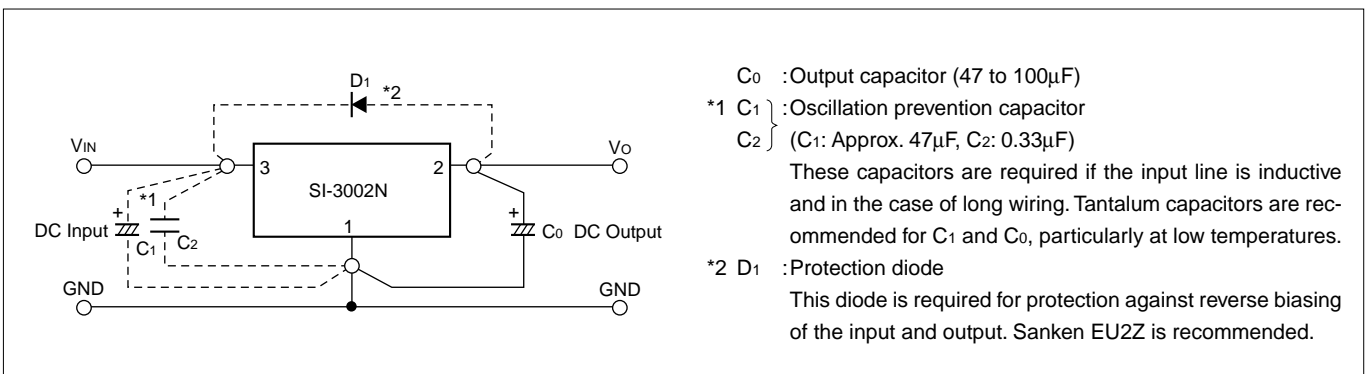

■ T_a - P_D Characteristics

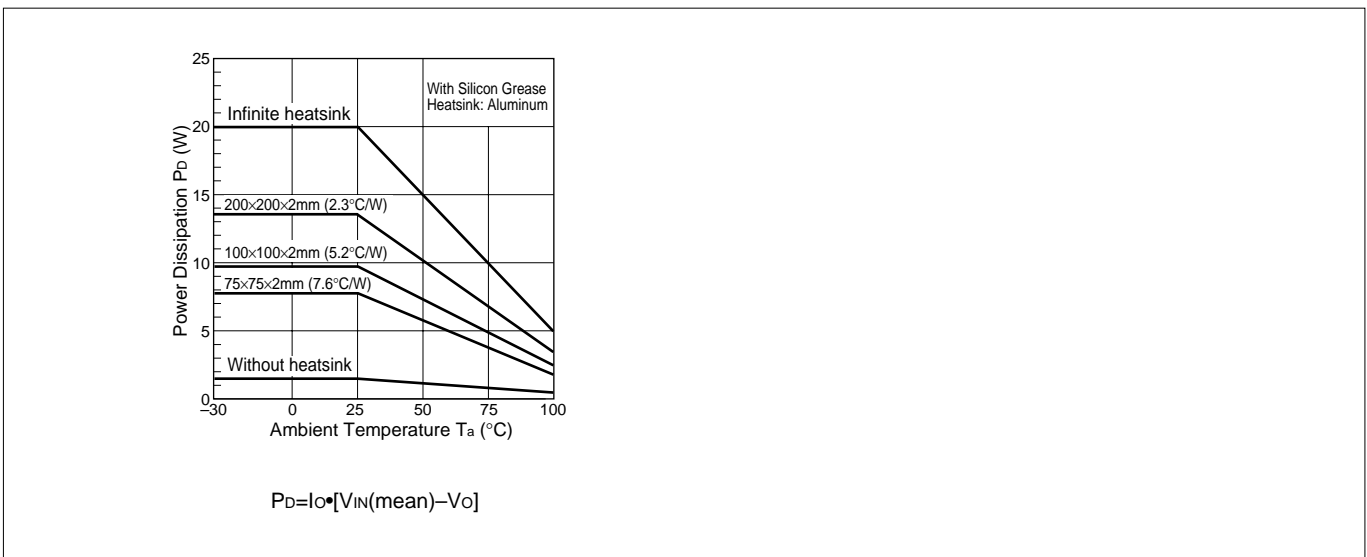

■Typical Characteristics

($T_a=25^\circ\text{C}$)

I_o vs. V_{DIF} Characteristics

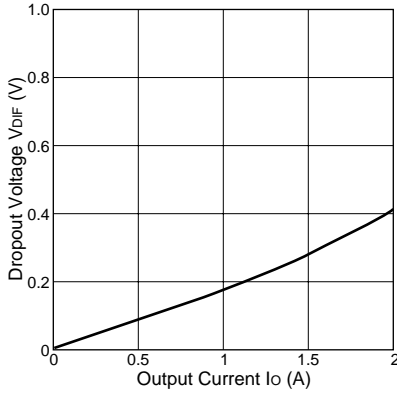

Temperature Coefficient of Output Voltage(SI-3052N)

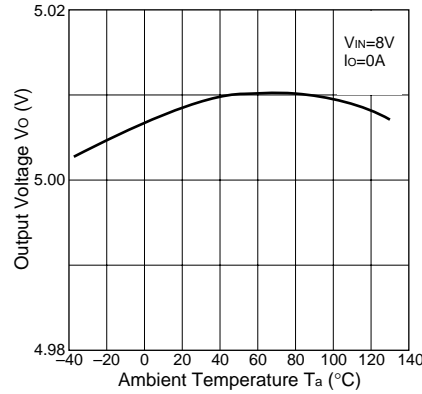

Output Voltage(SI-3052N)

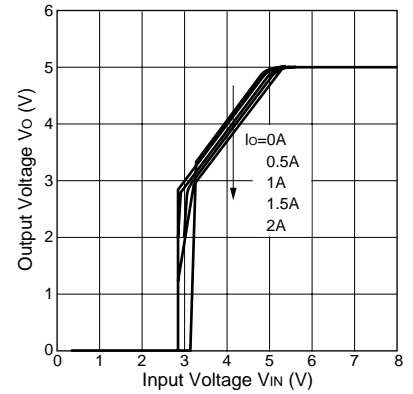

Output Voltage(SI-3122N)

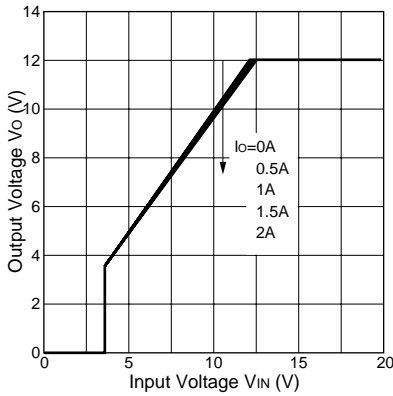

Overcurrent Protection Characteristics(SI-3052N)

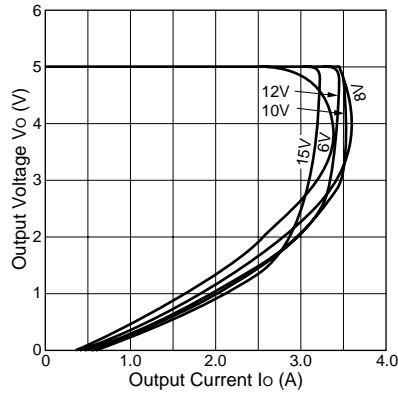

Overcurrent Protection Characteristics(SI-3122N)

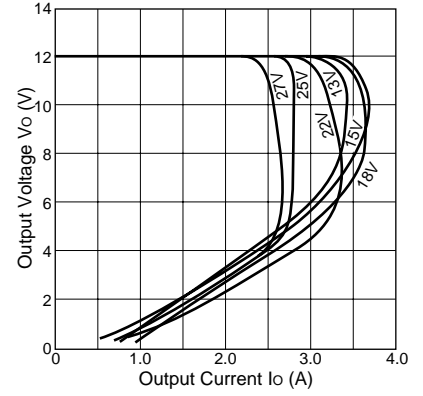

Thermal Protection Characteristics(SI-3052N)

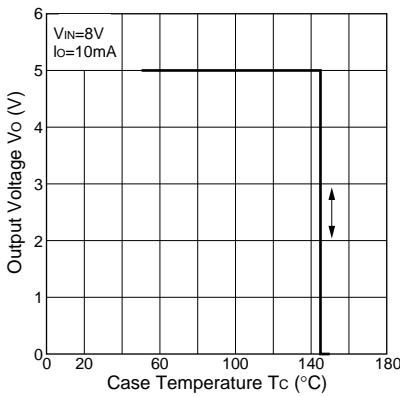

Note on Thermal Protection:

The thermal protection circuit is intended for protection against heat during instantaneous short-circuiting. Its operation is not guaranteed for continuous heating condition such as short-circuiting over extended periods of time.

SI-3000B Series

5-Terminal, Multi-Function, Full-Mold, Low Dropout Voltage Dropper Type

■Features

- Compact full-mold package (equivalent to TO220)
- Output current: 0.27A
- Low dropout voltage: $V_{DIF} \leq 0.5V$ (at $I_o = 0.27A$)
- Output ON/OFF control terminal is compatible with LS-TTL. (It may be directly driven by LS-TTL or standard CMOS logic.)
- Built-in foldback overcurrent, thermal protection circuits
- Accurate overcurrent protection starting current
 SI-3157B : 0.3 to 0.7A ($V_{IN} = 18V$)
 SI-3025B : 0.3 to 0.7A (When $V_{IN} = 18V$, at $V_o = 15.7V$)
 0.3 to 0.75A (When $V_{IN} = 18V$, at $V_o = 11.7V$)
- Variable output voltage type (SI-3025B) also available



■Applications

- For BS and CS antenna power supplies
- Electronic equipment

■Absolute Maximum Ratings

($T_a = 25^\circ C$)

Parameter	Symbol	Rated	Unit
DC Input Voltage	V_{IN}	35	V
Voltage of Output Control Terminal	V_c	V_{IN}	V
DC Output Current	I_o	0.27 ^{*1}	A
Power Dissipation	P_{D1}	14(With infinite heatsink)	W
	P_{D2}	1.5(Without heatsink, stand-alone operation)	W
Junction Temperature	T_j	-40 to +125	$^\circ C$
Ambient Operating Temperature	T_{op}	-30 to +100	$^\circ C$
Storage Temperature	T_{stg}	-40 to +125	$^\circ C$
Thermal Resistance (junction to case)	$R_{th(j-c)}$	7.0	$^\circ C/W$
Thermal Resistance (junction to ambient air)	$R_{th(j-a)}$	66.7(Without heatsink, stand-alone operation)	$^\circ C/W$

■Electrical Characteristics

(Ta=25°C unless otherwise specified)

Parameter	Symbol	Ratings						Unit	
		SI-3157B			SI-3025B				
		min.	typ.	max.	min.	typ.	max.		
Input Voltage	V _{IN}	*2		27*1	6*2,6		27*1	V	
Output Voltage (SI-3025B: Reference Voltage)	V _O (V _{REF})	14.92	15.70	16.48	2.448	2.550	2.652	V	
	Conditions	V _{IN} =18V, I _O =0.2A			V _{IN} =V _O +3V, I _O =0.2A				
Dropout Voltage	V _{DIF}			0.5			0.5	V	
	Conditions	I _O ≤0.27A			I _O ≤0.27A				
Line Regulation	ΔV _{OLINE}		30	90			10	mV (3025B: mV/V)	
	Conditions	V _{IN} =17 to 27V, I _O =0.2A			V _{IN} =(V _O +1) to 27V, I _O =0.27A				
Load Regulation	ΔV _{OLOAD}		120	300			10	mV (3025B: mV/V)	
	Conditions	V _{IN} =18V, I _O =0 to 0.27A			V _{IN} =V _O +3V, I _O =0 to 0.27A				
Temperature Coefficient of Output Voltage (SI-3025B: Temperature Coefficient of Reference Voltage)	ΔV _O /ΔT _a (ΔV _{REF} /ΔT _a)		±1.5			±0.5		mV/°C	
	Conditions	V _{IN} =18V, I _O =5mA, T _J =0 to 100°C			V _{IN} =V _O +3V, I _O =5mA, T _J =0 to 100°C				
Ripple Rejection	R _{REJ}		54			54		dB	
	Conditions	V _{IN} =18V, f=100 to 120Hz			V _{IN} =V _O +3V, f=100 to 120Hz				
Quiescent Circuit Current	I _q		3	10		3	10	mA	
	Conditions	V _{IN} =18V, I _O =0A			V _{IN} =V _O +3V, I _O =0A				
Overcurrent Protection Starting Current*3,4	I _{S1}	0.3		0.7	0.3		0.75	A	
	Conditions	V _{IN} =18V			V _{IN} =18V, at V _O =11.7V				
					0.3		0.7		
	Conditions				V _{IN} =18V, at V _O =15.7V				
V _c Terminal*5	Control Voltage (Output ON)	V _c . IH	2.0		2.0			V	
	Control Voltage (Output OFF)	V _c . IL			0.8		0.8		
	Control Current (Output ON)	I _c . IH			20		20	μA	
		Conditions	V _c =2.7V			V _c =2.7V			
	Control Current (Output OFF)	I _c . IL			-0.3		-0.3		
		Conditions	V _c =0.4V			V _c =0.4V			mA

*1: V_{IN(max)} and I_{O(max)} are restricted by the relation P_{D(max)}=(V_{IN}-V_O)•I_O=14(W).

*2: Refer to the dropout voltage.(Refer to Setting DC Input Voltage on page 7.)

*3: I_{S1} is specified at -5(%) drop point of output voltage V_O on the condition that V_{IN}=V_O+3V, I_O=0.2A.

*4: A foldback type overcurrent protection circuit is built into the IC regulator. Therefore, avoid using it for the following applications as it may cause starting errors:

- (1) Constant current load (2) Plus/minus power (3) Series power (4) V_O adjustment by raising ground voltage

*5: Output is ON even when output control terminal V_c is open. Each input level is equivalent to LS-TTL. Therefore, it may be directly driven by an LS-TTL circuit.

*6. When setting output voltage to 5V or less, input voltage needs to be set to 6V or over to operate stably.

■External Dimensions

(unit:mm)

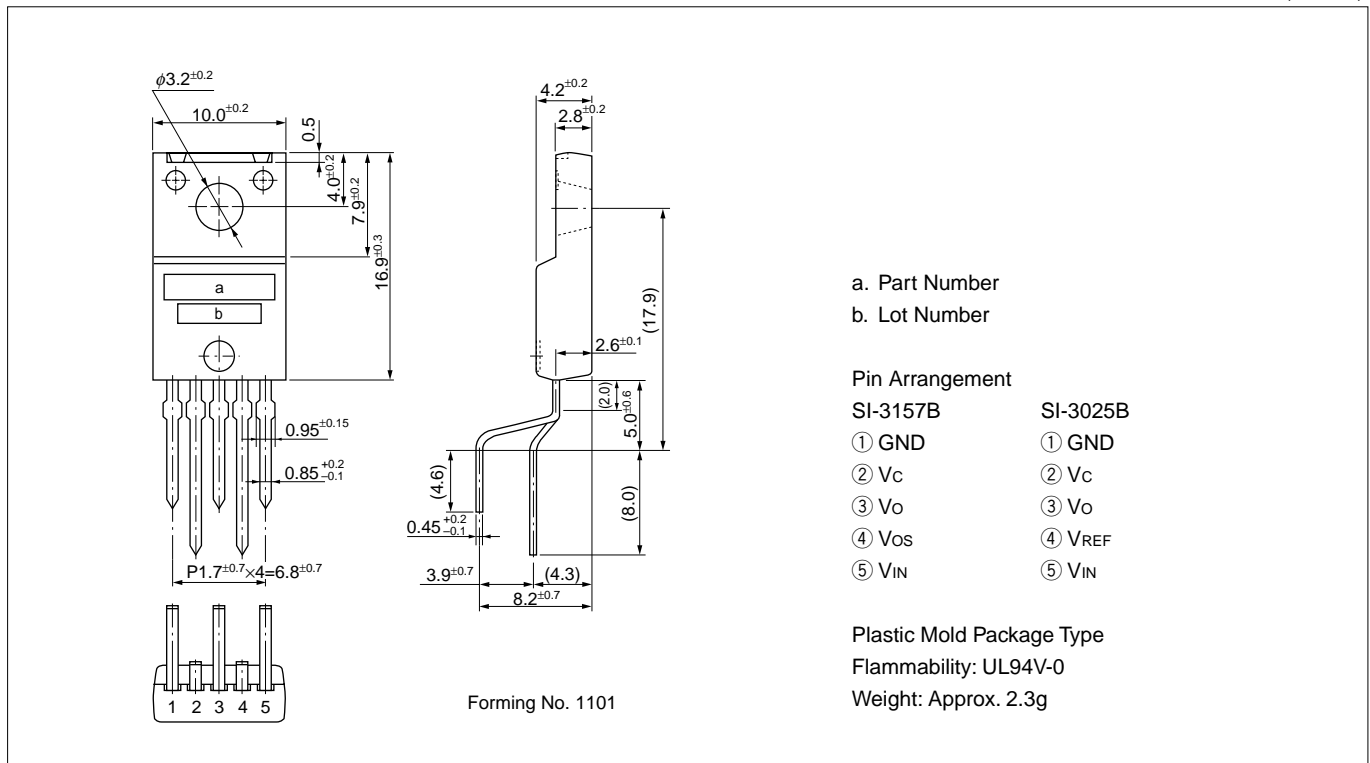

■Block Diagram

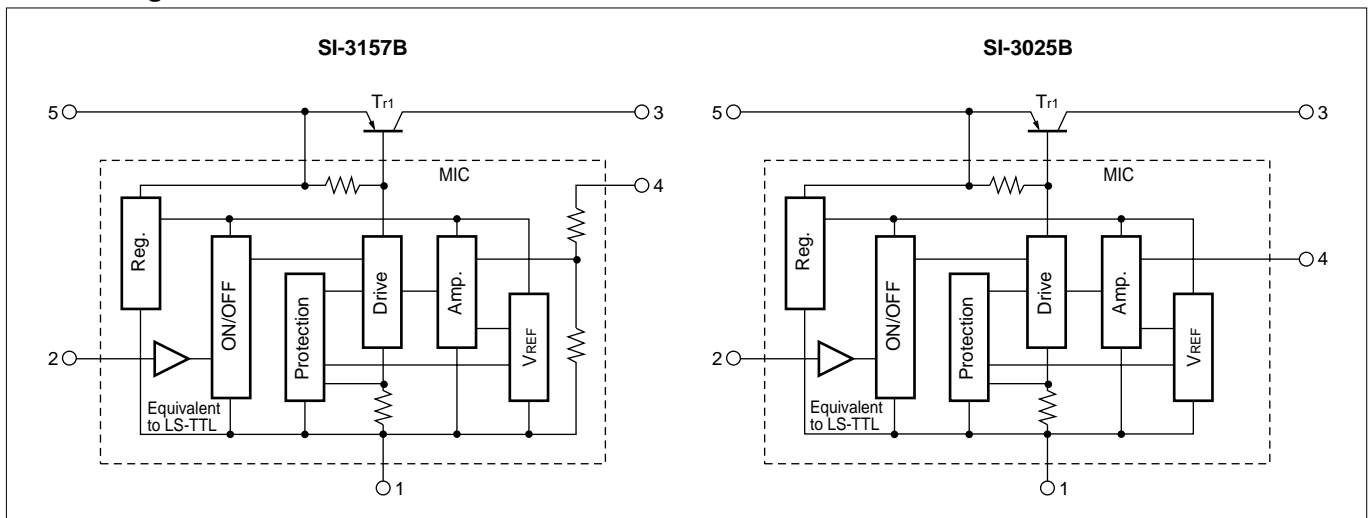

■Standard External Circuit

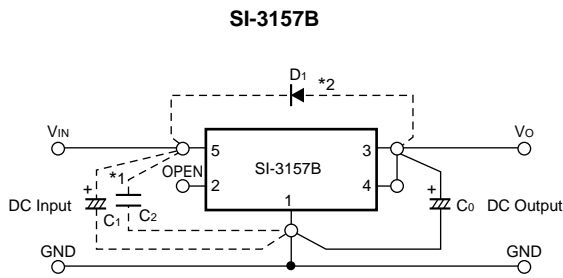

C_0 : Output capacitor (47 to 100 μ F)
 *1 C_1 } : Oscillation prevention capacitor
 C_2 }

(C_1 : Approx. 47 μ F, C_2 : 0.33 μ F)
 These capacitors are required if the input line is inductive and in the case of long wiring. Tantalum capacitors are recommended for C_1 and C_0 , particularly at low temperatures.

*2 D_1 : Protection diode

This diode is required for protection against reverse biasing of the input and output. Sanken EU2Z is recommended.

*3 R_1 } : External resistor for setting output voltage

R_2 } Relationship between output voltage V_o and external resistors R_1 and R_2 is as follows.

$$V_o = V_{REF} \cdot \left(1 + \frac{R_1}{R_2} \right) \quad (V_{REF} = 2.55V(\text{typ.}))$$

R_2 must be 2.55k Ω for stable operation.

SI-3025B

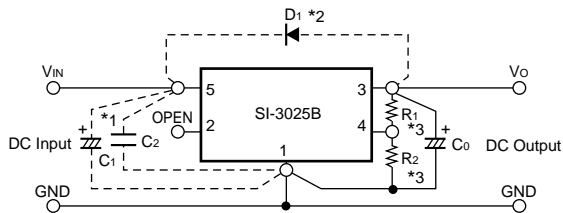

■ T_a - P_d Characteristics

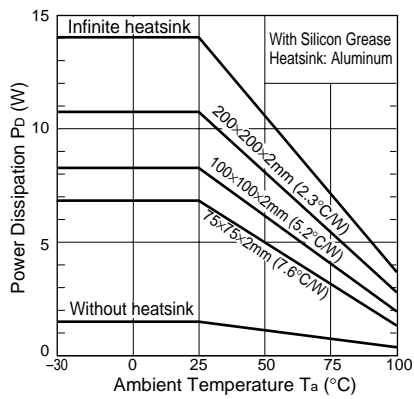

$$P_D = I_o \cdot [V_{IN}(\text{mean}) - V_o]$$

■Typical Characteristics (at $V_o=15.7V$ for SI3025B)

($T_a=25^\circ C$)

I_o vs. V_{DIF} Characteristics

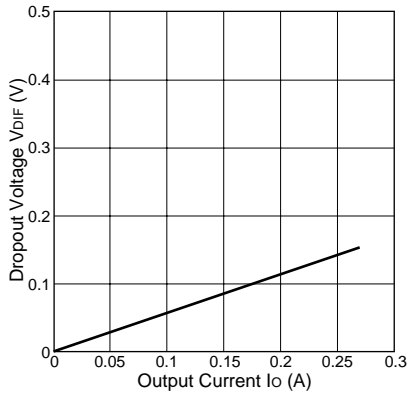

Temperature Coefficient of Output Voltage(SI-3157B)

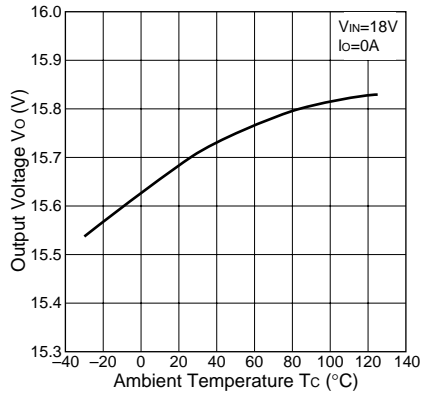

Output Voltage(SI-3157B)

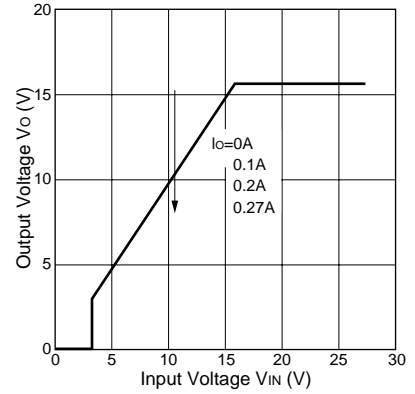

Line Regulation

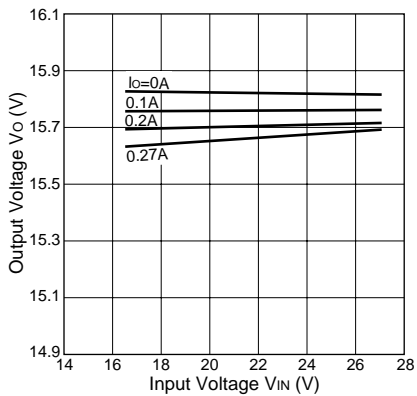

Load Regulation

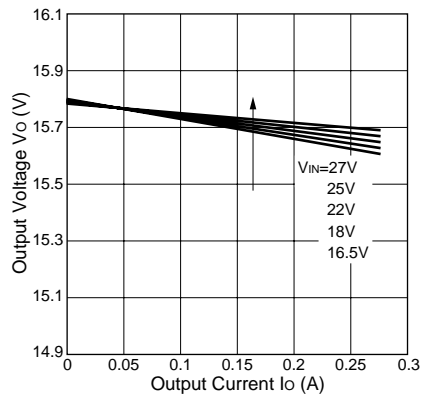

Overcurrent Protection Characteristics(SI-3157B)

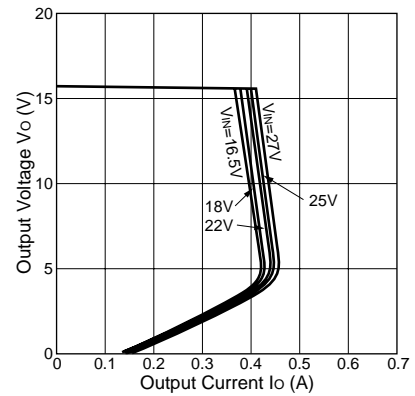

Output ON/OFF Control

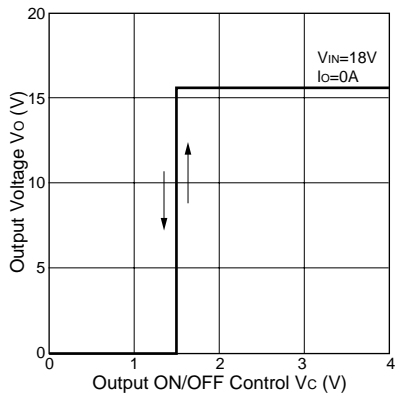

Thermal Protection Characteristics

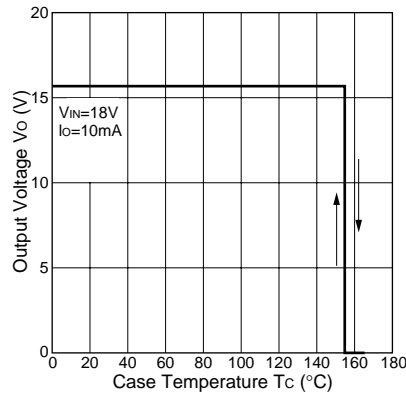

Note on Thermal Protection:

The thermal protection circuit is intended for protection against heat during instantaneous short-circuiting. Its operation is not guaranteed for continuous heating condition such as short-circuiting over extended periods of time.

SI-3000F Series

5-Terminal, Multi-Function, Full-Mold, Low Dropout Voltage Dropper Type

■Features

- Compact full-mold package (equivalent to TO220)
- Output current: 1.0A
- Low dropout voltage: $V_{DIF} \leq 1V$ (at $I_o = 1.0A$)
- Variable output voltage (rise only)
 - May be used for remote sensing (excluding SI-3025F)
- Output ON/OFF control terminal is compatible with LS-TTL.
(It may be directly driven by LS-TTL or standard CMOS logic.)
- Built-in foldback overcurrent, overvoltage, thermal protection circuits
- Variable output voltage type (SI-3025F) also available

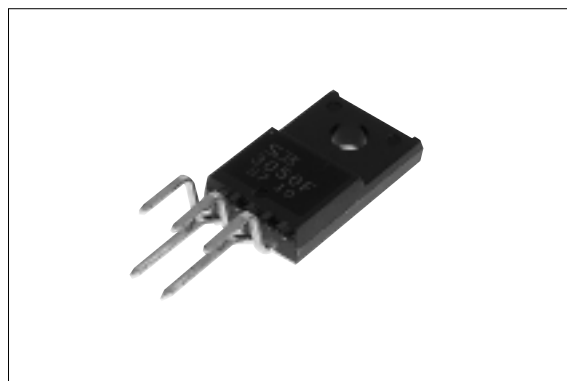

■Applications

- For stabilization of the secondary stage of switching power supplies
- Electronic equipment

■Absolute Maximum Ratings

(T_a=25°C)

Parameter	Symbol	Ratings					Unit
		SI-3050F	SI-3090F/3120F	SI-3150F/3157F	SI-3240F	SI-3025F	
DC Input Voltage	V _{IN}	25	30	35	45	30	V
Voltage of Output Control Terminal	V _c	V _{IN}					V
DC Output Current	I _o	1.0 ^{*2}					A
Power Dissipation	P _{D1}	14 ^{**} (With infinite heatsink)					W
	P _{D2}	1.5(Without heatsink, stand-alone operation)					W
Junction Temperature	T _j	-40 to +125					°C
Ambient Operating Temperature	T _{op}	-30 to +100					°C
Storage Temperature	T _{stg}	-40 to +125					°C
Thermal Resistance (junction to case)	R _{th(j-c)}	7.0 ^{***}					°C/W
Thermal Resistance (junction to ambient air)	R _{th(j-a)}	66.7(Without heatsink, stand-alone operation)					°C/W

** SI-3240F: 18

*** SI-3240F: 5.5

■Electrical Characteristics (except SI-3025F)

(Ta=25°C unless otherwise specified)

Parameter	Symbol	Ratings																		Unit	
		SI-3050F			SI-3090F			SI-3120F			SI-3150F			SI-3157F			SI-3240F				
		min.	typ.	max.	min.	typ.	max.	min.	typ.	max.	min.	typ.	max.	min.	typ.	max.	min.	typ.	max.		
Input Voltage	V _{IN}	6 ³		15 ²	10 ³		20 ²	13 ³		25 ²	16 ³		27 ²	16.7 ³		27 ²	25 ³		40 ²	V	
Output Voltage	SI-3000F ^{*1}	4.80	5.00	5.20	8.64	9.00	9.36	11.52	12.00	12.48	14.40	15.00	15.60	14.92	15.70	16.48	23.04	24.00	24.96	V	
	SI-3000FA	4.90	5.00	5.10	8.82	9.00	9.18	11.76	12.00	12.24	14.70	15.00	15.30								
	Conditions	V _{IN} =8V, I _O =0.5A			V _{IN} =12V, I _O =0.5A			V _{IN} =15V, I _O =0.5A			V _{IN} =18V, I _O =0.5A			V _{IN} =19V, I _O =0.5A			V _{IN} =27V, I _O =0.5A				
Dropout Voltage	V _{DIF}			0.5			0.5			0.5			0.5			0.5			0.5	V	
	Conditions	I _O ≤0.5A																			
	Conditions			1.0			1.0			1.0			1.0			1.0			1.0		
	Conditions	I _O ≤1.0A																			
Line Regulation	ΔV _{OLINE}		10	30		18	48		24	64		30	90		30	90		48	128	mV	
	Conditions	V _{IN} =6V to 15V, I _O =0.5A			V _{IN} =10V to 20V, I _O =0.5A			V _{IN} =13V to 25V, I _O =0.5A			V _{IN} =16V to 27V, I _O =0.5A			V _{IN} =17V to 27V, I _O =0.5A			V _{IN} =25V to 38V, I _O =0.5A				
Load Regulation	ΔV _{OLOAD}		40	100		70	180		93	240		120	300		120	300		120	300	mV	
	Conditions	V _{IN} =8V, I _O =0 to 1.0A			V _{IN} =12V, I _O =0 to 1.0A			V _{IN} =15V, I _O =0 to 1.0A			V _{IN} =18V, I _O =0 to 1.0A			V _{IN} =19V, I _O =0 to 1.0A			V _{IN} =27V, I _O =0 to 1.0A				
Temperature Coefficient of Output Voltage	ΔV _O /ΔT _a		±0.5			±1.0			±1.5			±1.5			±1.5			±2.5		mV/°C	
	Conditions	V _{IN} =8V, I _O =5mA, T _J =0 to 100°C			V _{IN} =12V, I _O =5mA, T _J =0 to 100°C			V _{IN} =15V, I _O =5mA, T _J =0 to 100°C			V _{IN} =18V, I _O =5mA, T _J =0 to 100°C			V _{IN} =19V, I _O =5mA, T _J =0 to 100°C			V _{IN} =27V, I _O =5mA, T _J =0 to 100°C				
Ripple Rejection	R _{REJ}		54			54			54			54			54			54		dB	
	Conditions	V _{IN} =8V, f=100 to 120Hz			V _{IN} =12V, f=100 to 120Hz			V _{IN} =15V, f=100 to 120Hz			V _{IN} =18V, f=100 to 120Hz			V _{IN} =19V, f=100 to 120Hz			V _{IN} =27V, f=100 to 120Hz				
Quiescent Circuit Current	I _q		3	10		3	10		3	10		3	10		3	10		5	10	mA	
	Conditions	V _{IN} =8V, I _O =0A			V _{IN} =12V, I _O =0A			V _{IN} =15V, I _O =0A			V _{IN} =18V, I _O =0A			V _{IN} =19V, I _O =0A			V _{IN} =27V, I _O =0A				
Overcurrent Protection Starting Current ^{*4,7}	I _{s1}	1.2			1.2			1.2			1.2			1.2			1.2			A	
	Conditions	V _{IN} =8V			V _{IN} =12V			V _{IN} =15V			V _{IN} =18V			V _{IN} =19V			V _{IN} =27V				
V _C Terminal ^{*5}	Control Voltage (Output ON)	V _C IH	2.0			2.0			2.0			2.0			2.0			2.0		V	
	Control Voltage (Output OFF)	V _C IL			0.8			0.8			0.8			0.8			0.8		0.8		
	Control Current (Output ON)	I _C IH			20			20			20			20			20		20		μA
	Conditions	V _C =2.7V																			
	Control Current (Output OFF)	I _C IL			-0.3			-0.3			-0.3			-0.3			-0.3		-0.3		mA
Conditions	V _C =0.4V																				

*1: "A" may be indicated to the right of the Sanken logo.

*2: V_{IN(max)} and I_{O(max)} are restricted by the relation P_{D(max)}=(V_{IN}-V_O)•I_O=14W(SI-3240F: 18W).

*3: Refer to the dropout voltage.(Refer to Setting DC Input Voltage on page 7.)

*4: I_{s1} is specified at -5(%) drop point of output voltage V_O on the condition that V_{IN}=V_O+3V, I_O=0.5A.

*5: Output is ON even when output control terminal VC is open. Each input level is equivalent to LS-TTL. Therefore, it may be directly driven by an LS-TTL circuit.

*6: When setting output voltage to 5V or less, input voltage needs to be set to 6V or over to operate stably.

*7: A foldback type overcurrent protection circuit is built into the IC regulator. Therefore, avoid using it for the following applications as it may cause starting errors:

- (1) Constant current load (2) Plus/minus power (3) Series power (4) V_O adjustment by raising ground voltage

■Electrical Characteristics (SI-3025F)

(T_a=25°C unless otherwise specified)

Parameter	Symbol	Ratings			Unit	
		SI-3025F				
		min.	typ.	max.		
Input Voltage	V _{IN}	6 ⁶		25 ²	V	
Output Voltage	V _O	3		24	V	
Reference Voltage	V _{REF}	2.45	2.55	2.65	V	
Dropout Voltage	V _{DIF}			0.5	V	
	Conditions	I _o ≤0.5A				
	Conditions	I _o ≤1.0A				
Line Regulation	ΔV _{OLINE}			10	mV/V	
	Conditions	V _{IN} =V _O +1 to 25V, I _o =0.5A				
Load Regulation	ΔV _{OLOAD}			20	mV/V	
	Conditions	V _{IN} =V _O +3V, I _o =0 to 1.0A				
Temperature Coefficient of Reference Voltage	ΔV _{REF} /ΔT _a		±0.5		mV/°C	
	Conditions	V _{IN} =V _O +3V, I _o =5mA, T _j =0 to 100°C				
Ripple Rejection	R _{REJ}		54		dB	
	Conditions	V _{IN} =V _O +3V, f=100 to 120Hz				
Quiescent Circuit Current	I _q		3	10	mA	
	Conditions	V _{IN} =V _O +3V, I _o =0A				
Overcurrent Protection Starting Current ^{4,7}	I _{S1}	1.2			A	
	Conditions	V _{IN} =V _O +3V				
V _c Terminal ¹⁵	Control Voltage (Output ON)	V _c IH	2.0		V	
	Control Voltage (Output OFF)	V _c IL		0.8		
	Control Current (Output ON)	I _c IH			20	μA
		Conditions	V _c =2.7V			
	Control Current (Output OFF)	I _c IL			-0.3	mA
		Conditions	V _c =0.4V			

■External Dimensions

(unit:mm)

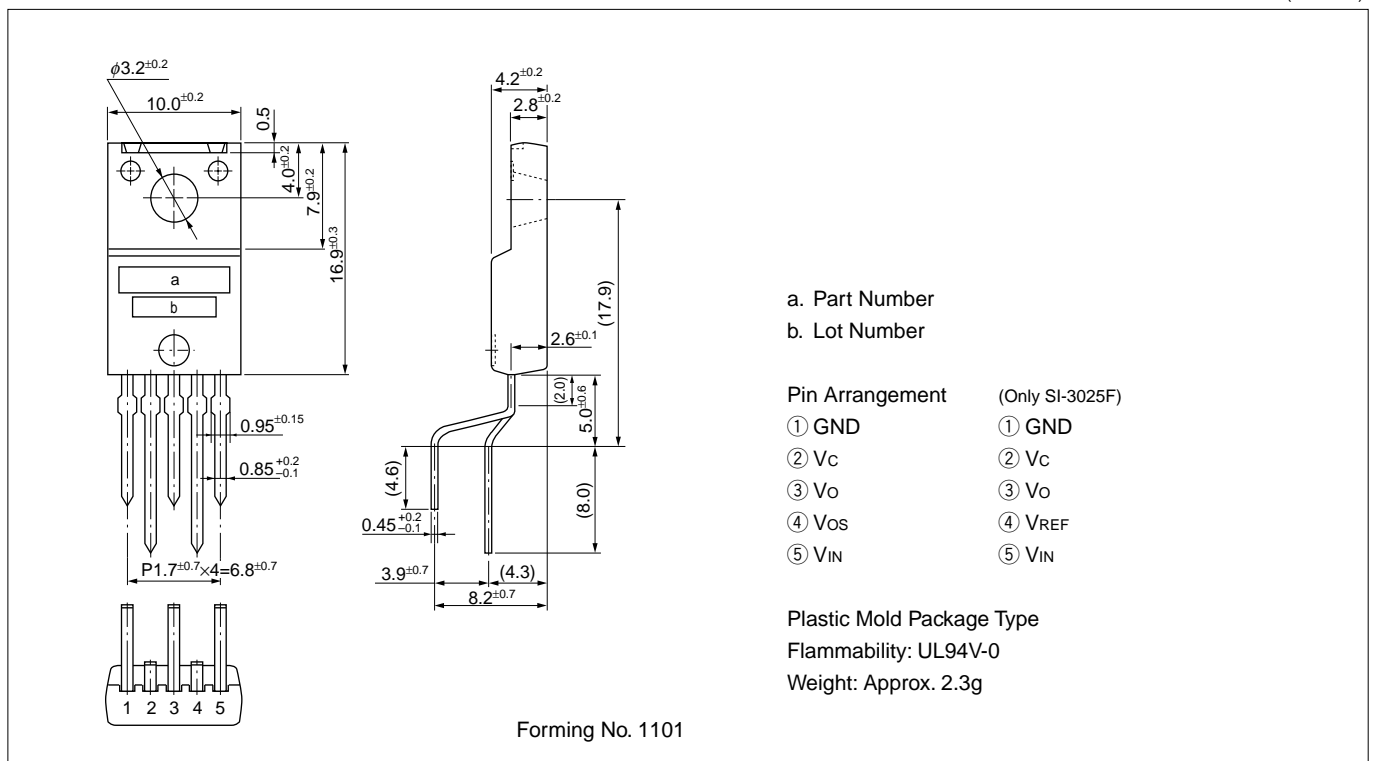

■Block Diagram

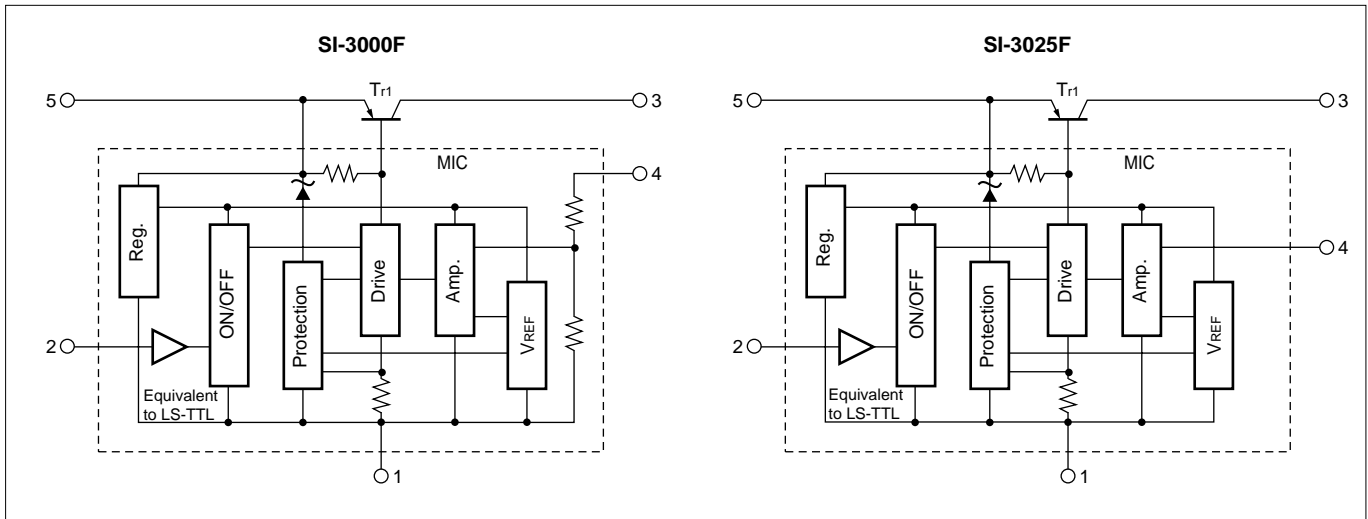

■Standard External Circuit

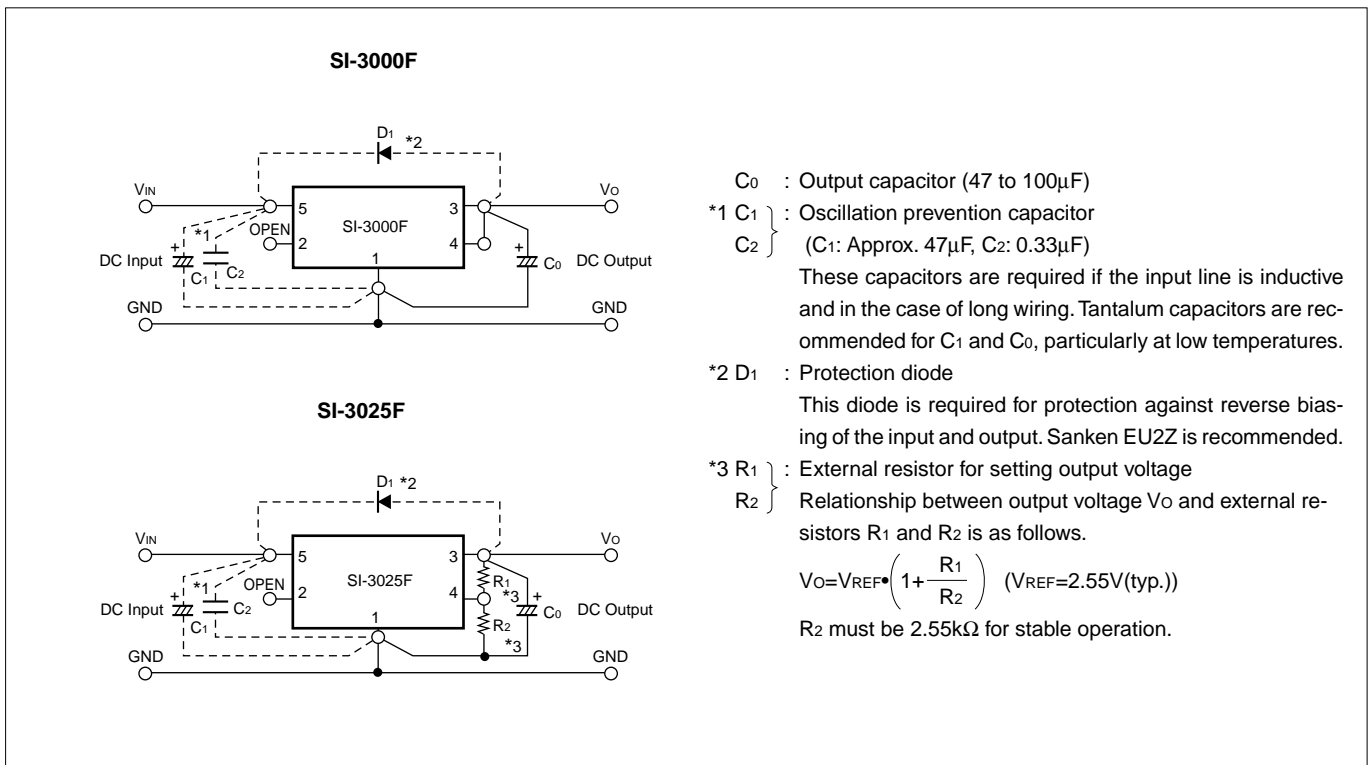

■T_a-P_d Characteristics

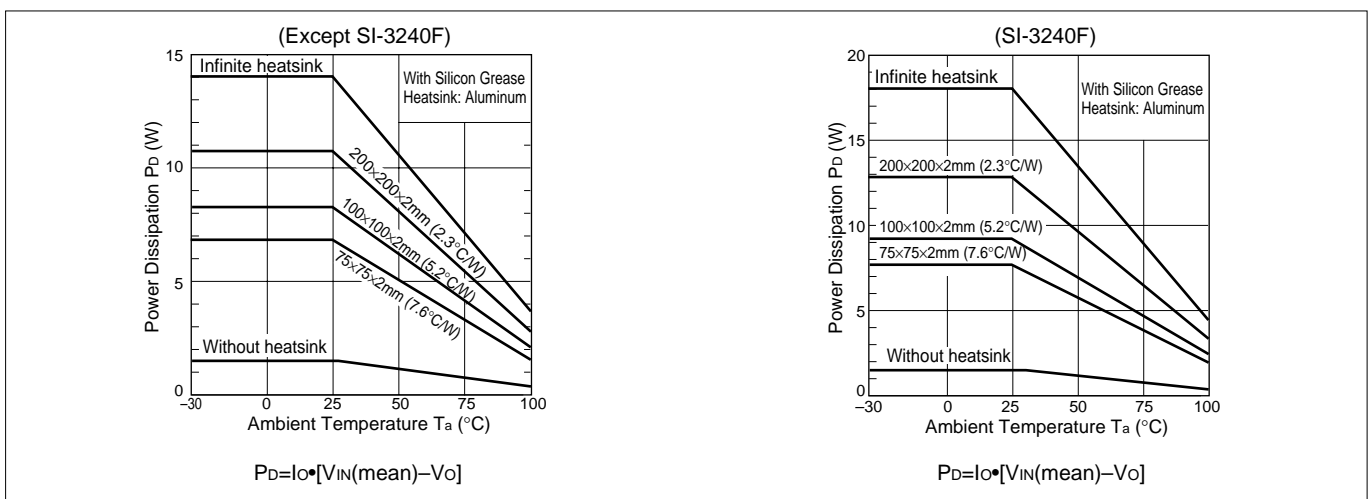

External Variable Output Voltage Circuit (Except SI-3025F)

1. Variable output voltage with a single external resistor

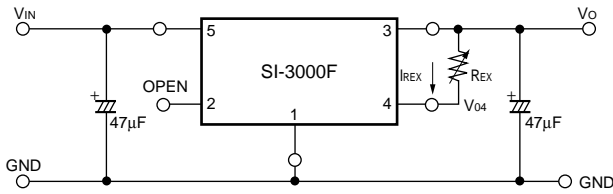

The output voltage may be increased by inserting resistor R_{EX} between terminals No.4 (sensing terminal) and No.3 (output terminal). The current I_{REX} flowing into terminal No.4 is 1mA (typ.), therefore the adjusted output voltage V_{OUT} is:

$$V_O = V_{04} + I_{REX} \cdot R_{EX} \quad *V_{04}: \text{output voltage of SI-3000F series}$$

However, the internal resistor (between terminals No. 4 and No.1) is a semiconductor resistor, which has approximately thermal characteristics of $+0.2\%/^{\circ}\text{C}$.

It is important to keep the thermal characteristics in mind when adjusting the output voltage.

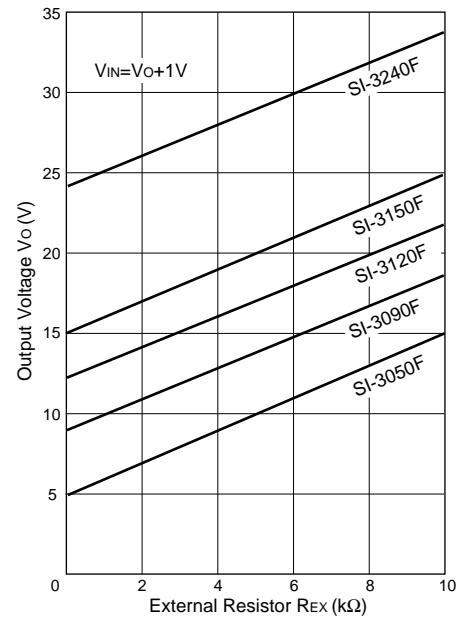

2. Variable output voltage with two external resistors

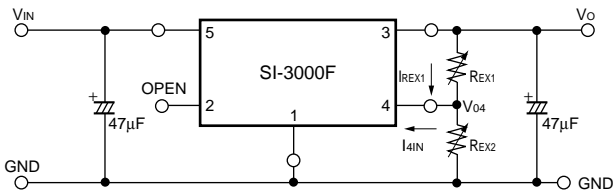

The output voltage may be increased by inserting resistors R_{EX1} between terminals No.4 (sensing terminal) and No.3 (output terminal) and R_{EX2} between terminals No.4 and No.1 (ground terminal).

The current I_{4IN} flowing into terminal No.4 is 1mA (typ.) so the thermal characteristics may be improved compared to the method shown in 1 by setting the external current I_{REX1} at approximately 5 times the value of I_{4IN} (stability coefficient $S=5$).

The adjusted output voltage V_{OUT} in this case is:

$$\begin{cases} V_O = V_{04} + R_{EX1} \cdot I_{REX1} \\ I_{REX1} = S \cdot I_{4IN} \end{cases}$$

The value of the external resistors may be obtained as follows:

$$R_{EX1} = \frac{V_O - V_{04}}{S \cdot I_{4IN}}, \quad R_{EX2} = \frac{V_{04}}{(S-1) \cdot I_{4IN}}$$

* V_{04} : Output voltage of SI-3000F series

S: Stability coefficient of I_{4IN} (may be set to any value)

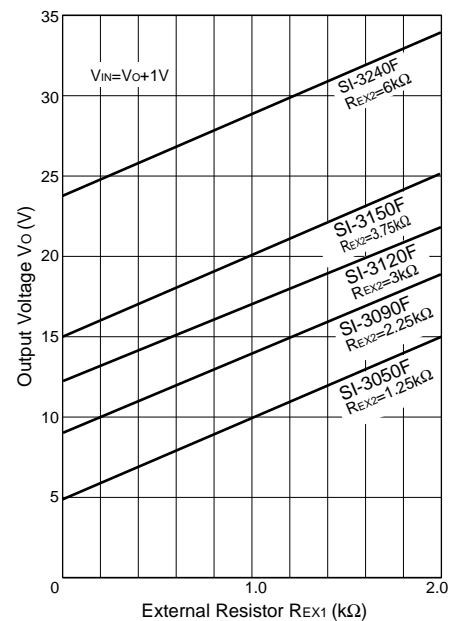

Note: In the SI-3000F series, the output voltage increase can be adjusted as mentioned above. However, when the rise is set to approximately 10V compared to output voltage V_{04} , the necessary output current may not be obtained due to the S.O.A. protection circuit in the SI-3000F series.

■Typical Characteristics

($T_a=25^\circ\text{C}$)

I_o vs. V_{DIF} Characteristics

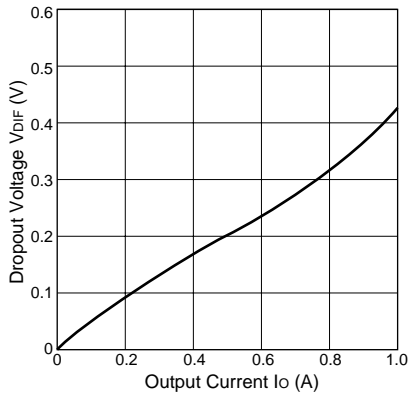

Temperature Coefficient of Output Voltage(SI-3050F)

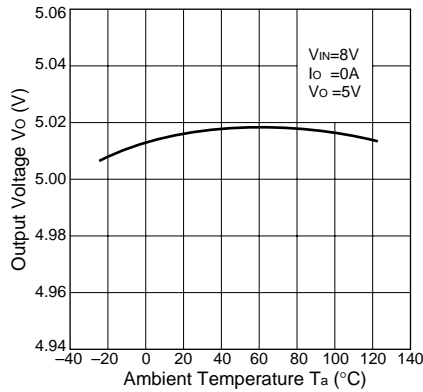

Output ON/OFF Control(SI-3050F)

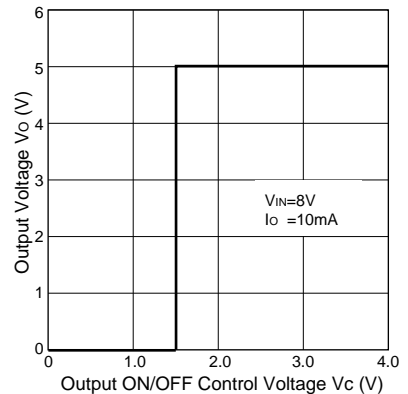

Output Voltage(SI-3050F)

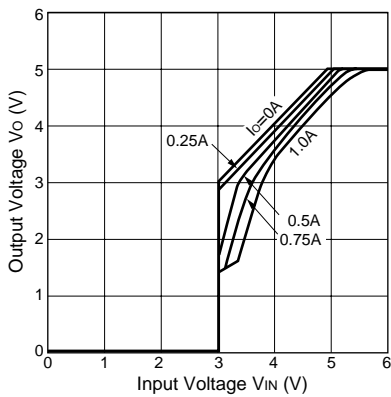

Output Voltage(SI-3120F)

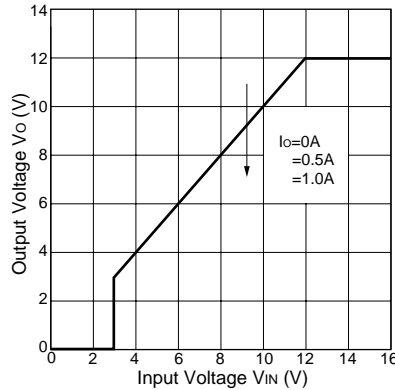

Overcurrent Protection Characteristics(SI-3050F)

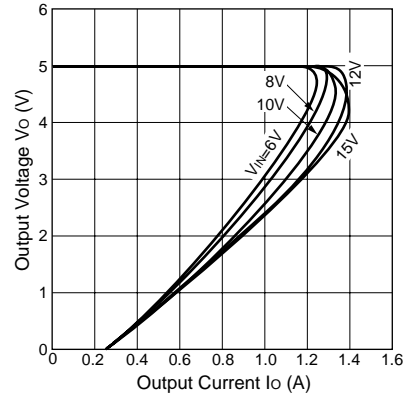

Overcurrent Protection Characteristics(SI-3120F)

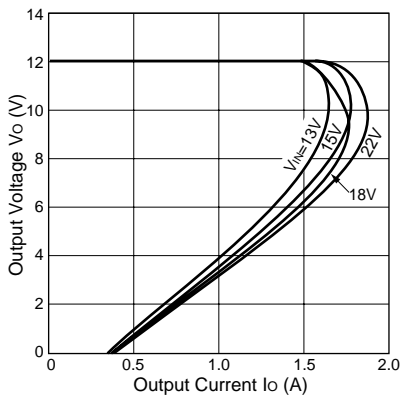

Overcurrent Protection Characteristics(SI-3240F)

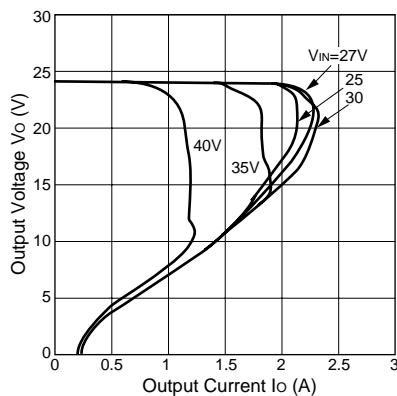

Thermal Protection Characteristics(SI-3050F)

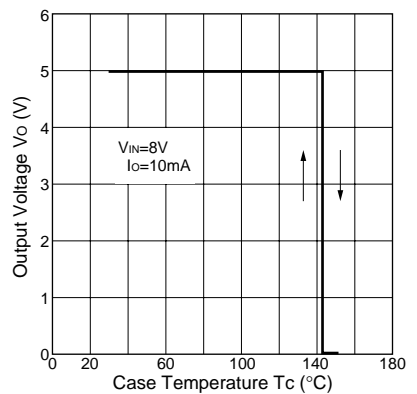

Note on Thermal Protection:

The thermal protection circuit is intended for protection against heat during instantaneous short-circuiting. Its operation is not guaranteed for continuous heating condition such as short-circuiting over extended periods of time.

SI-3000C Series

5-Terminal, Multi-Function, Full-Mold, Low Dropout Voltage Dropper Type

■Features

- Compact full-mold package (equivalent to TO220)
- Output current: 1.5A
- Low dropout voltage: $V_{DIF} \leq 1V$ (at $I_o = 1.5A$)
- Variable output voltage (rise only)
May be used for remote sensing
- Output ON/OFF control terminal is compatible with LS-TTL.
(It may be directly driven by LS-TTL or standard CMOS logic.)
- Built-in foldback overcurrent (SI-3033C: Drooping type overcurrent),
overvoltage, thermal protection circuits

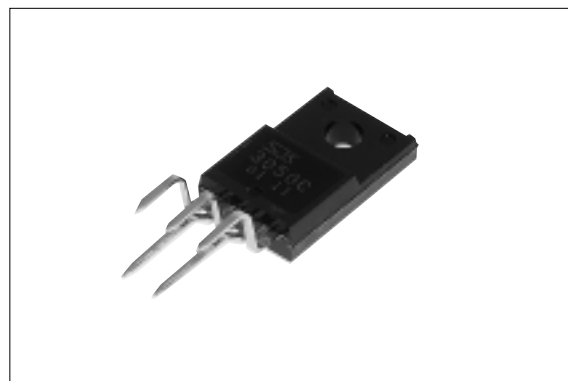

■Applications

- For stabilization of the secondary stage of switching power supplies
- Electronic equipment

■Absolute Maximum Ratings

(T_a=25°C)

Parameter	Symbol	Ratings				Unit
		SI-3033C	SI-3050C/3090C	SI-3120C/3150C	SI-3240C	
DC Input Voltage	V _{IN}	20	35	35	45	V
Voltage of Output Control Terminal	V _c	V _{IN}				V
DC Output Current	I _o	1.5 ²				A
Power Dissipation	P _{D1}	18(With infinite heatsink)				W
	P _{D2}	1.5(Without heatsink, stand-alone operation)				W
Junction Temperature	T _j	-40 to +125				°C
Ambient Operating Temperature	T _{op}	-30 to +100				°C
Storage Temperature	T _{stg}	-40 to +125				°C
Thermal Resistance (junction to case)	R _{th(j-c)}	5.5				°C/W
Thermal Resistance (junction to ambient air)	R _{th(j-a)}	66.7(Without heatsink, stand-alone operation)				°C/W

■Electrical Characteristics

(T_a=25°C unless otherwise specified)

Parameter	Symbol	Ratings									Unit
		SI-3033C			SI-3050C			SI-3090C			
		min.	typ.	max.	min.	typ.	max.	min.	typ.	max.	
Input Voltage	V _{IN}	*3		15 ²	6 ³		30 ²	10 ³		30 ²	V
Output Voltage	SI-3000C *1	3.168	3.300	3.432	4.80	5.00	5.20	8.64	9.00	9.36	V
	SI-3000CA	3.234	3.300	3.366	4.90	5.00	5.10	8.82	9.00	9.18	
Dropout Voltage	Conditions	V _{IN} =5V, I _o =1.0A			V _{IN} =8V, I _o =1.0A			V _{IN} =12V, I _o =1.0A			V
	V _{DIF}			0.5			0.5			0.5	
	Conditions	I _o ≤1.0A									
Line Regulation	Conditions			1.0			1.0			1.0	mV
	Conditions	I _o ≤1.5A									
Load Regulation	ΔV _{LINE}		10	30		10	30		18	48	mV
	Conditions	V _{IN} =4.5 to 12V, I _o =1.0A			V _{IN} =6 to 15V, I _o =1.0A			V _{IN} =10 to 20V, I _o =1.0A			
Temperature Coefficient of Output Voltage	ΔV _{LOAD}		40	100		40	100		70	180	mV
	Conditions	V _{IN} =5V, I _o =0 to 1.5A			V _{IN} =8V, I _o =0 to 1.5A			V _{IN} =12V, I _o =0 to 1.5A			
Ripple Rejection	ΔV _o /ΔT _a		±0.5			±0.5			±1.0		mV/°C
	Conditions	V _{IN} =5V, I _o =5mA, T _j =0 to 100°C			V _{IN} =8V, I _o =5mA, T _j =0 to 100°C			V _{IN} =12V, I _o =5mA, T _j =0 to 100°C			
Quiescent Circuit Current	R _{REJ}		54			54			54		dB
	Conditions	V _{IN} =5V, f=100 to 120Hz			V _{IN} =8V, f=100 to 120Hz			V _{IN} =12V, f=100 to 120Hz			
Overcurrent Protection Starting Current*4,6	I _q		3	10		5	10		5	10	mA
	Conditions	V _{IN} =5V, I _o =0A			V _{IN} =8V, I _o =0A			V _{IN} =12V, I _o =0A			
Control Voltage (Output ON)	I _{s1}	1.6			1.6			1.6			A
	Conditions	V _{IN} =5V			V _{IN} =8V			V _{IN} =12V			
V _c Terminal ⁵	Control Voltage (Output OFF)	V _c IH	2.0		2.0			2.0			V
	Control Voltage (Output OFF)	V _c IL		0.8			0.8			0.8	
	Control Current (Output ON)	I _c IH		20			20			20	μA
	Control Current (Output ON)	Conditions	V _c =2.7V								
Control Current (Output OFF)	I _c IL			-0.3			-0.3			-0.3	mA
	Conditions	V _c =0.4V									

*1: "A" may be indicated to the right of the Sanken logo.

*2: V_{IN(max)} and I_{o(max)} are restricted by the relation P_{D(max)}=(V_{IN}-V_o)•I_o=18(W).

*3: Refer to the dropout voltage.(Refer to Setting DC Input Voltage on page 7.)

*4: I_{s1} is specified at -5(%) drop point of output voltage V_o on the condition that V_{IN}=V_o+3V, I_o=1A.

*5: Output is ON even when output control terminal V_c is open. Each input level is equivalent to LS-TTL. Therefore, it may be directly driven by an LS-TTL circuit.

*6: A foldback type overcurrent protection circuit is built into the I_c regulator (excluding SI-3033C). Therefore, avoid using it for the following applications as it may cause starting errors:

- (1) Constant current load (2) Plus/minus power (3) Series power (4) V_o adjustment by raising ground voltage

■Electrical Characteristics

(Ta=25°C unless otherwise specified)

Parameter	Symbol	Ratings									Unit	
		SI-3120C			SI-3150C			SI-3240C				
		min.	typ.	max.	min.	typ.	max.	min.	typ.	max.		
Input Voltage	V _{IN}	13 ³		30 ²	16 ³		30 ²	25 ³		40 ²	V	
Output Voltage	SI-3000C *1	11.52	12.00	12.48	14.40	15.00	15.60	23.04	24.00	24.96	V	
	SI-3000CA	11.76	12.00	12.24	14.70	15.00	15.30	23.52	24.00	24.48		
Dropout Voltage	Conditions	V _{IN} =15V, I _O =1.0A			V _{IN} =18V, I _O =1.0A			V _{IN} =27V, I _O =1.0A			V	
	V _{DIF}			0.5			0.5			0.5		
	Conditions	I _O ≤1.0A										
Line Regulation	ΔV _{OLINE}		24	64		30	90		48	128	mV	
	Conditions	V _{IN} =13 to 25V, I _O =1.0A			V _{IN} =16 to 25V, I _O =1.0A			V _{IN} =25 to 38V, I _O =1.0A				
Load Regulation	ΔV _{OLOAD}		93	240		120	300		120	300	mV	
	Conditions	V _{IN} =15V, I _O =0 to 1.5A			V _{IN} =18V, I _O =0 to 1.5A			V _{IN} =27V, I _O =0 to 1.5A				
Temperature Coefficient of Output Voltage	ΔV _O /ΔT _a		±1.5			±1.5			±2.5		mV/°C	
	Conditions	V _{IN} =15V, I _O =5mA, T _J =0 to 100°C			V _{IN} =18V, I _O =5mA, T _J =0 to 100°C			V _{IN} =27V, I _O =5mA, T _J =0 to 100°C				
Ripple Rejection	R _{REJ}		54			54			54		dB	
	Conditions	V _{IN} =15V, f=100 to 120Hz			V _{IN} =18V, f=100 to 120Hz			V _{IN} =27V, f=100 to 120Hz				
Quiescent Circuit Current	I _q		5	10		5	10		5	10	mA	
	Conditions	V _{IN} =15V, I _O =0A			V _{IN} =18V, I _O =0A			V _{IN} =27V, I _O =0A				
Overcurrent Protection Starting Current*4,6	I _{S1}	1.6			1.6			1.6			A	
	Conditions	V _{IN} =15V			V _{IN} =18V			V _{IN} =27V				
V _c Terminal ⁵	Control Voltage (Output ON)	V _c IH	2.0		2.0			2.0			V	
	Control Voltage (Output OFF)	V _c IL			0.8		0.8			0.8		
	Control Current (Output ON)	I _c IH			20			20			20	μA
		Conditions	V _c =2.7V									
Control Current (Output OFF)	I _c IL			-0.3			-0.3			-0.3	mA	
	Conditions	V _c =0.4V										

*1: "A" may be indicated to the right of the Sanken logo.

*2: V_{IN(max)} and I_{O(max)} are restricted by the relation P_{D(max)}=(V_{IN}-V_O)•I_O=18(W).

*3: Refer to the dropout voltage.(Refer to Setting DC Input Voltage on page 7.)

*4: I_{S1} is specified at -5(%) drop point of output voltage V_O on the condition that V_{IN}=V_O+3V, I_O=1A.

*5: Output is ON even when output control terminal V_c is open. Each input level is equivalent to LS-TTL. Therefore, it may be directly driven by an LS-TTL circuit.

*6: A foldback type overcurrent protection circuit is built into the I_c regulator. Therefore, avoid using it for the following applications as it may cause starting errors:

- (1) Constant current load (2) Plus/minus power (3) Series power (4) V_O adjustment by raising ground voltage

■External Dimensions

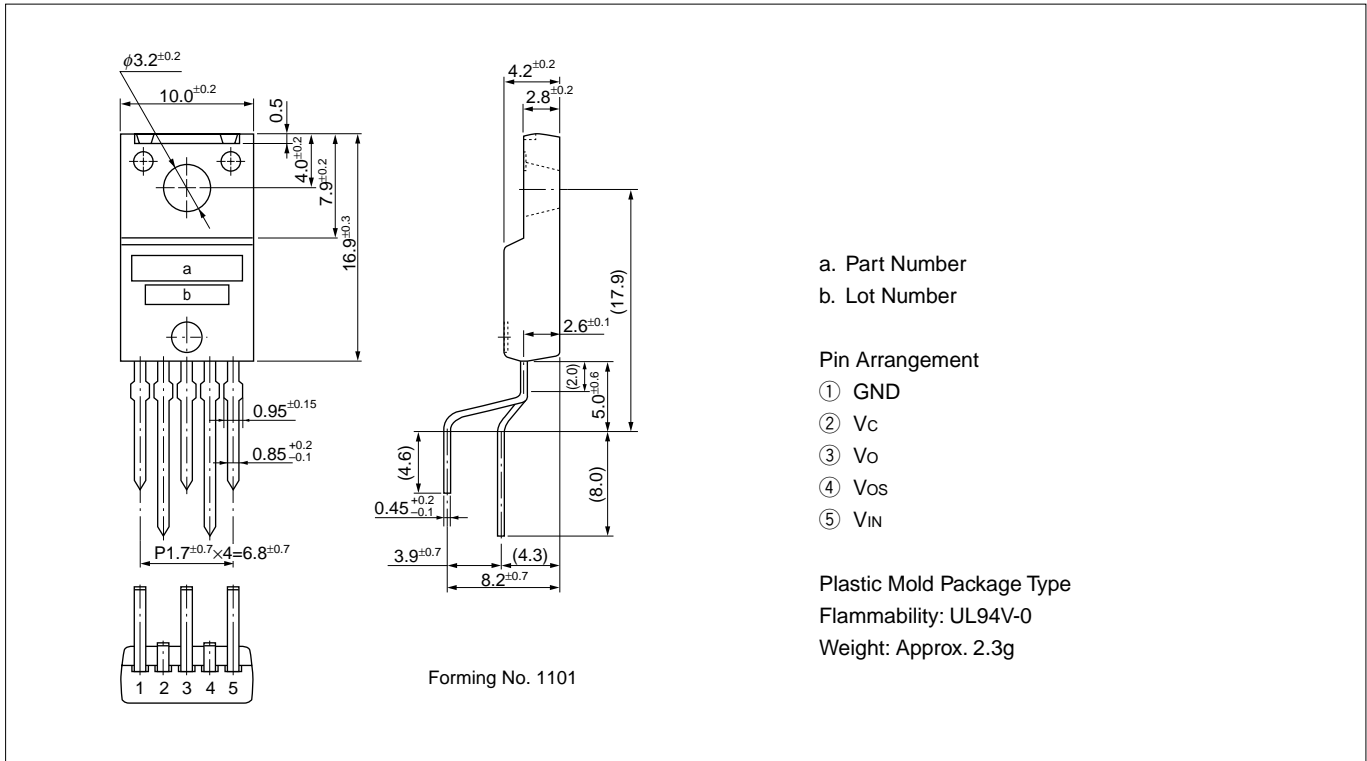

■Block Diagram

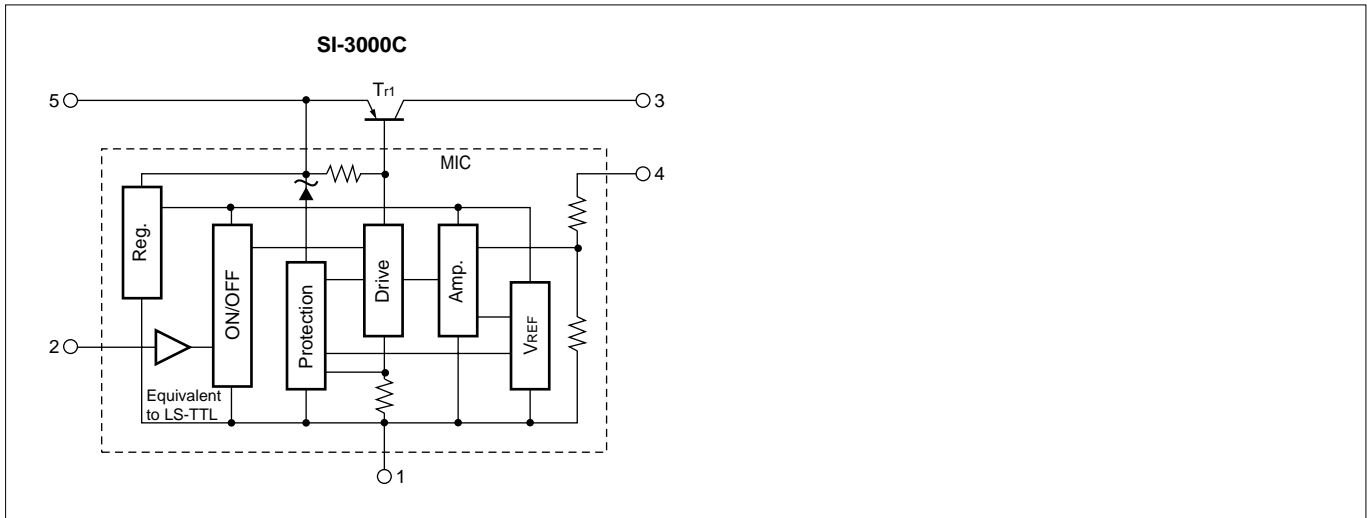

■Standard External Circuit

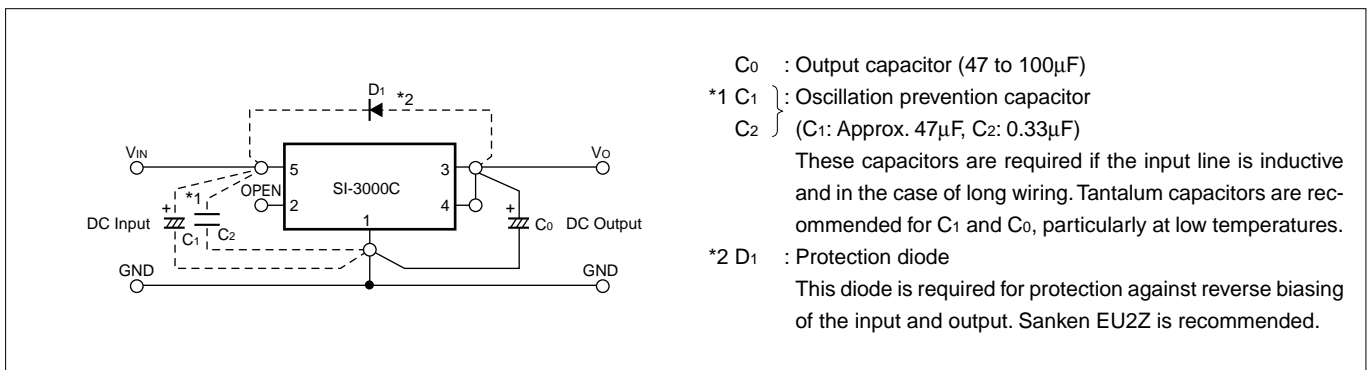

■ T_a - P_D Characteristics

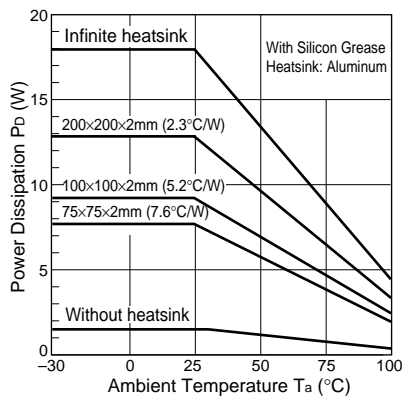

$$P_D = I_O \cdot [V_{IN(\text{mean})} - V_O]$$

External Variable Output Voltage Circuit

1. Variable output voltage with a single external resistor

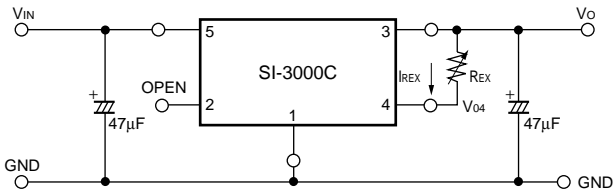

The output voltage may be increased by inserting resistor R_{EX} between terminals No.4 (sensing terminal) and No.3 (output terminal). The current I_{REX} flowing into terminal No.4 is 1mA (typ.)(SI-3033C:0.43mA (typ.)), therefore the adjusted output voltage V_{OUT} is:

$$V_O = V_{04} + I_{REX} \cdot R_{EX} \quad *V_{04}: \text{output voltage of SI-3000C series}$$

However, the internal resistor (between terminals No. 4 and No.1) is a semiconductor resistor, which has approximately thermal characteristics of +0.2%/°C.

It is important to keep the thermal characteristics in mind when adjusting the output voltage.

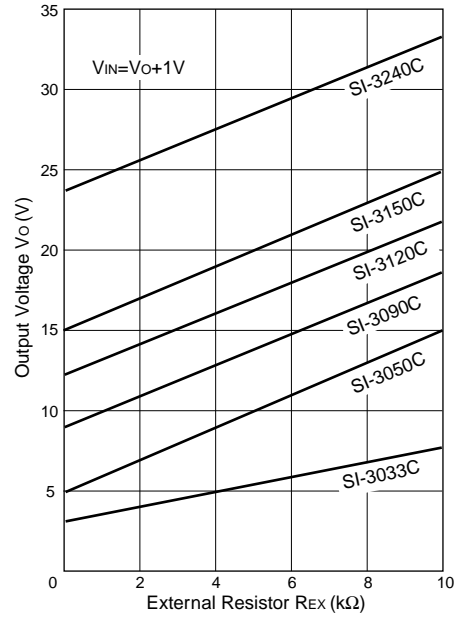

2. Variable output voltage with two external resistors

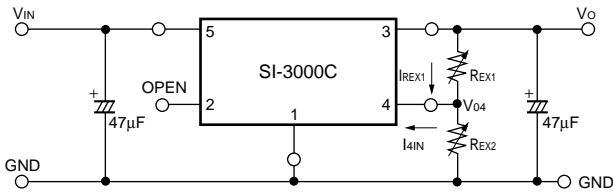

The output voltage may be increased by inserting resistors R_{EX1} between terminals No.4 (sensing terminal) and No.3 (output terminal) and R_{EX2} between terminals No.4 and No.1 (ground terminal).

The current I_{4IN} flowing into terminal No.4 is 1mA (typ.)(SI-3033C: 0.43mA (typ.)) so the thermal characteristics may be improved compared to the method shown in 1 by setting the external current I_{REX1} at approximately 5 times the value of I_{4IN} (stability coefficient $S=5$).

The adjusted output voltage V_{OUT} in this case is:

$$\begin{cases} V_O = V_{04} + R_{EX1} \cdot I_{REX1} \\ I_{REX1} = S \cdot I_{4IN} \end{cases}$$

The value of the external resistors may be obtained as follows:

$$R_{EX1} = \frac{V_O - V_{04}}{S \cdot I_{4IN}}, \quad R_{EX2} = \frac{V_{04}}{(S-1) \cdot I_{4IN}}$$

* V_{04} : Output voltage of SI-3000C series

S: Stability coefficient of I_{4IN} (may be set to any value)

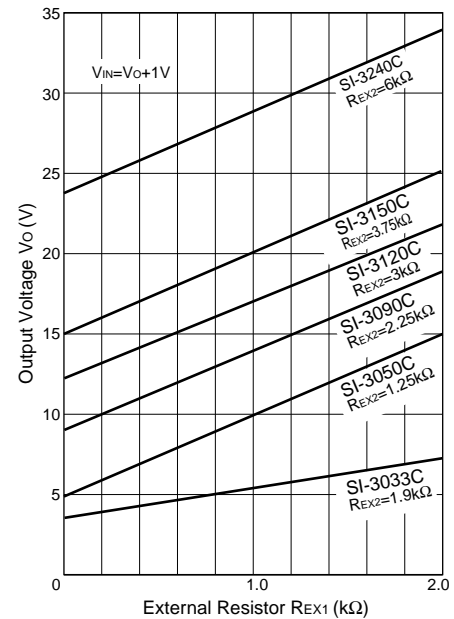

Note: In the SI-3000C series, the output voltage increase can be adjusted as mentioned above. However, when the rise is set to approximately 10V compared to output voltage V_{04} , the necessary output current may not be obtained due to the S.O.A. protection circuit in the SI-3000C series.

■Typical Characteristics

($T_a=25^\circ\text{C}$)

Io vs. VDIF Characteristics

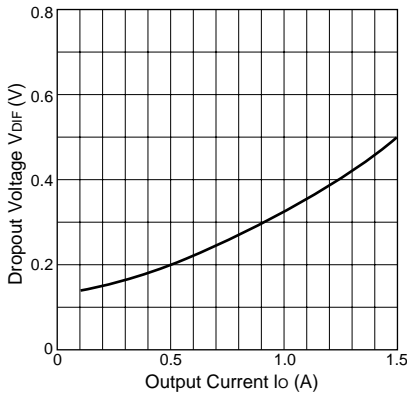

Temperature Coefficient of Output Voltage(SI-3050C)

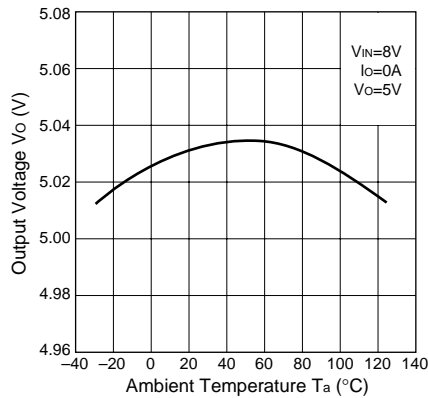

Circuit Current(SI-3050C)

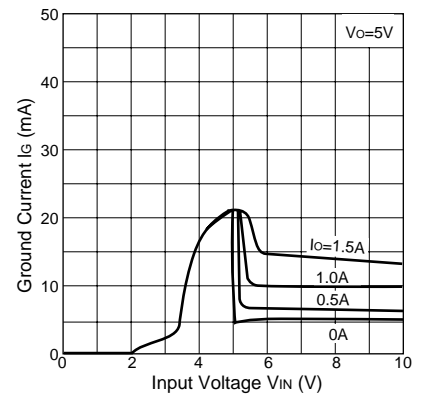

Output Voltage(SI-3033C)

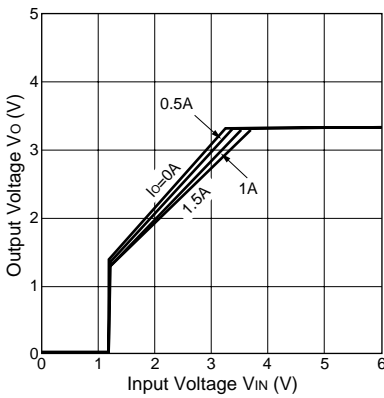

Output Voltage(SI-3050C)

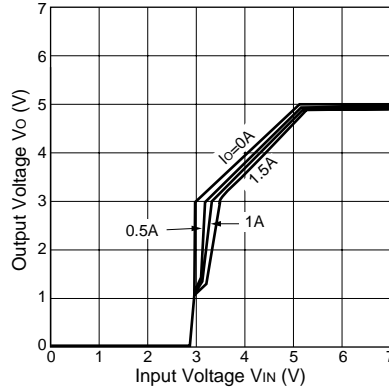

Output Voltage(SI-3240C)

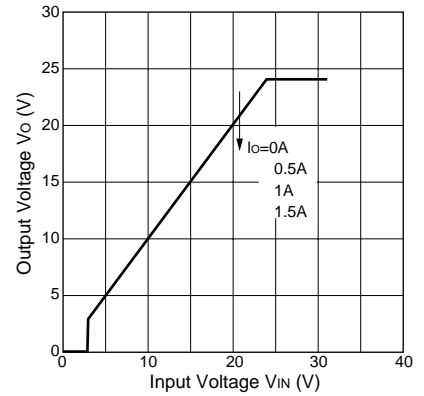

Overcurrent Protection Characteristics(SI-3033C)

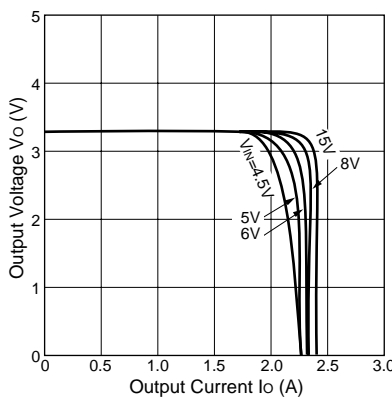

Overcurrent Protection Characteristics(SI-3050C)

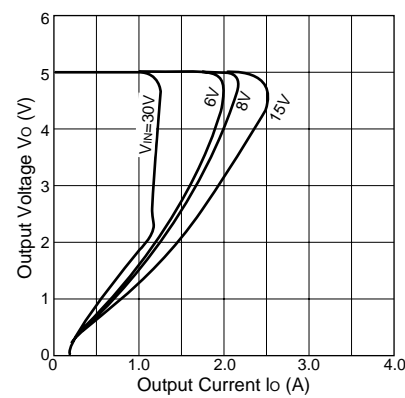

Overcurrent Protection Characteristics(SI-3240C)

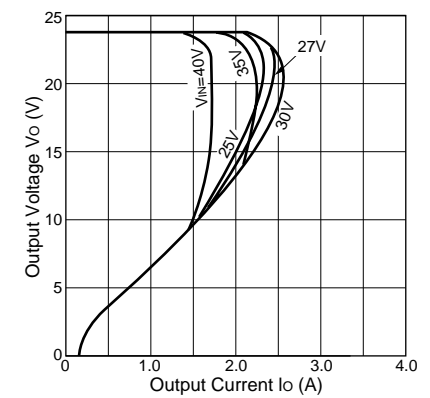

ON/OFF Control Characteristics(SI-3050C)

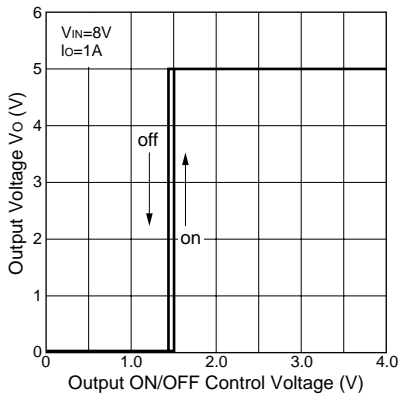

Thermal Protection Characteristics(SI-3050C)

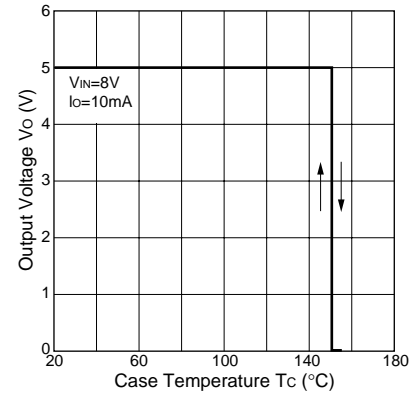

Note on Thermal Protection:

The thermal protection circuit is intended for protection against heat during instantaneous short-circuiting. Its operation is not guaranteed for continuous heating condition such as short-circuiting over extended periods of time.

SI-3000J Series

5-Terminal, Multi-Function, Full-Mold, Low Dropout Voltage Dropper Type

■Features

- Compact full-mold package (equivalent to TO220)
- Output current: 2.0A
- Low dropout voltage: $V_{DIF} \leq 1V$ (at $I_o = 2.0A$)
- Variable output voltage (rise only) May be used for remote sensing
- Output ON/OFF control terminal is compatible with LS-TTL.
(It may be directly driven by LS-TTL or standard CMOS logic.)
- Built-in foldback overcurrent, overvoltage, thermal protection circuits

■Applications

- For stabilization of the secondary stage of switching power supplies
- Electronic equipment



■Absolute Maximum Ratings

($T_a = 25^\circ C$)

Parameter	Symbol	Ratings			Unit
		SI-3050J	SI-3090J	SI-3120J/3150J	
DC Input Voltage	V_{IN}	25	30	35	V
Voltage of Output Control Terminal	V_c	V_{IN}			V
DC Output Current	I_o	2.0^{*1}			A
Power Dissipation	P_{D1}	20(With infinite heatsink)			W
	P_{D2}	1.5(Without heatsink, stand-alone operation)			W
Junction Temperature	T_j	-40 to +125			$^\circ C$
Ambient Operating Temperature	T_{op}	-30 to +100			$^\circ C$
Storage Temperature	T_{stg}	-40 to +125			$^\circ C$
Thermal Resistance (junction to case)	$R_{th(j-c)}$	5.0			$^\circ C/W$
Thermal Resistance (junction to ambient air)	$R_{th(j-a)}$	66.7(Without heatsink, stand-alone operation)			$^\circ C/W$

■Electrical Characteristics

(Ta=25°C unless otherwise specified)

Parameter	Symbol	Ratings												Unit	
		SI-3050J			SI-3090J			SI-3120J			SI-3150J				
		min.	typ.	max.	min.	typ.	max.	min.	typ.	max.	min.	typ.	max.		
Input Voltage	V _{IN}	6 ²		15 ¹	10 ²		25 ¹	13 ²		27 ¹	16 ²		27 ¹	V	
Output Voltage	V _O	4.90	5.00	5.10	8.82	9.00	9.18	11.76	12.00	12.24	14.70	15.00	15.30	V	
	Conditions	V _{IN} =8V, I _O =1.0A			V _{IN} =12V, I _O =1.0A			V _{IN} =15V, I _O =1.0A			V _{IN} =18V, I _O =1.0A				
Dropout Voltage	V _{DIF}			0.5			0.5			0.5			0.5	V	
	Conditions	I _O ≤1.5A													
	Conditions			1.0			1.0			1.0			1.0		
Line Regulation	ΔV _{OLINE}		10	30		18	48		24	64		30	90	mV	
	Conditions	V _{IN} =6 to 15V, I _O =1.0A			V _{IN} =10 to 20V, I _O =1.0A			V _{IN} =13 to 25V, I _O =1.0A			V _{IN} =16 to 25V, I _O =1.0A				
Load Regulation	ΔV _{OLOAD}		40	100		70	180		93	240		120	300	mV	
	Conditions	V _{IN} =8V, I _O =0 to 2.0A			V _{IN} =12V, I _O =0 to 2.0A			V _{IN} =15V, I _O =0 to 2.0A			V _{IN} =18V, I _O =0 to 2.0A				
Temperature Coefficient of Output Voltage	ΔV _O /ΔT _a		±0.5			±1.0			±1.5			±1.5		mV/°C	
	Conditions	V _{IN} =8V, I _O =5mA, T _J =0 to 100°C			V _{IN} =12V, I _O =5mA, T _J =0 to 100°C			V _{IN} =15V, I _O =5mA, T _J =0 to 100°C			V _{IN} =18V, I _O =5mA, T _J =0 to 100°C				
Ripple Rejection	R _{REJ}		54			54			54			54		dB	
	Conditions	V _{IN} =8V, f=100 to 120Hz			V _{IN} =12V, f=100 to 120Hz			V _{IN} =15V, f=100 to 120Hz			V _{IN} =18V, f=100 to 120Hz				
Quiescent Circuit Current	I _q		3	10		3	10		3	10		3	10	mA	
	Conditions	V _{IN} =8V, I _O =0A			V _{IN} =12V, I _O =0A			V _{IN} =15V, I _O =0A			V _{IN} =18V, I _O =0A				
	I _q (off)		0.5	1.0		0.5	1.0		0.5	1.0		0.5	1.0	mA	
Conditions	V _{IN} =8V, I _O =0A, V _C =0.4V			V _{IN} =12V, I _O =0A, V _C =0.4V			V _{IN} =15V, I _O =0A, V _C =0.4V			V _{IN} =18V, I _O =0A, V _C =0.4V					
Overcurrent Protection Starting Current ^{*3,5}	I _{S1}	2.1			2.1			2.1			2.1			A	
	Conditions	V _{IN} =8V			V _{IN} =12V			V _{IN} =15V			V _{IN} =18V				
V _C Terminal ^{*4}	Control Voltage (Output ON)	V _C IH	2.0			2.0			2.0			2.0		V	
	Control Voltage (Output OFF)	V _C IL			0.8			0.8			0.8		0.8		
	Control Current (Output ON)	I _C IH			20			20			20			20	μA
		Conditions	V _C =2.7V												
	Control Current (Output OFF)	I _C IL			-0.3			-0.3			-0.3			-0.3	mA
Conditions		V _C =0.4V													

*1: V_{IN(max)} and I_{O(max)} are restricted by the relation P_{D(max)}=(V_{IN}-V_O)•I_O≤20(W).

*2: Refer to the dropout voltage.(Refer to Setting DC Input Voltage on page 7.)

*3: I_{S1} is specified at -5(%) drop point of output voltage V_O on the condition that V_{IN}=V_O+3V, I_O=1A.

*4: Output is ON even when output control terminal V_C is open. Each input level is equivalent to LS-TTL. Therefore, it may be directly driven by an LS-TTL circuit.

*5: A foldback type overcurrent protection circuit is built into the I_C regulator. Therefore, avoid using it for the following applications as it may cause starting errors:

- (1) Constant current load (2) Plus/minus power (3) Series power (4) V_O adjustment by raising ground voltage

■External Dimensions

(unit:mm)

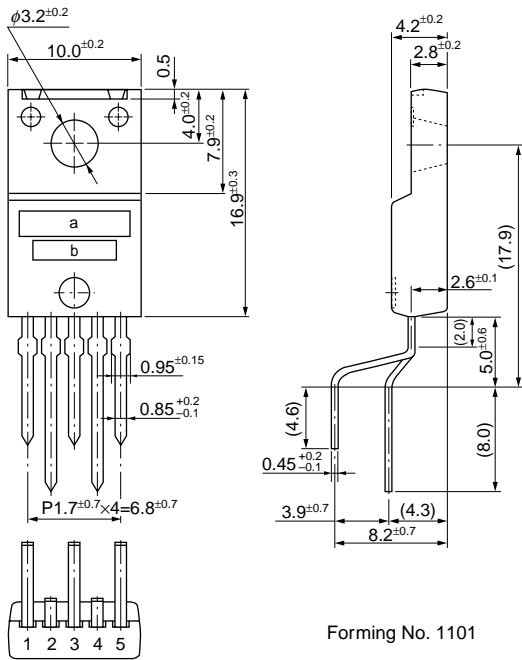

a. Part Number
b. Lot Number

Pin Arrangement

- ① GND
- ② Vc
- ③ Vo
- ④ Vos
- ⑤ Vin

Plastic Mold Package Type
Flammability: UL94V-0
Weight: Approx. 2.3g

■Block Diagram

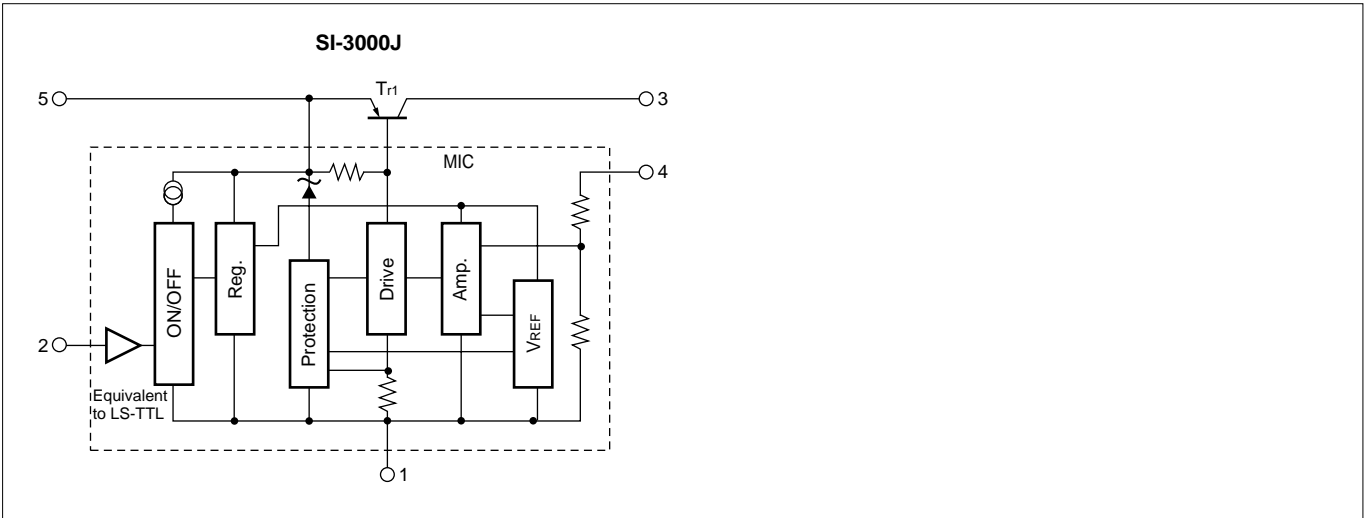

■Standard External Circuit

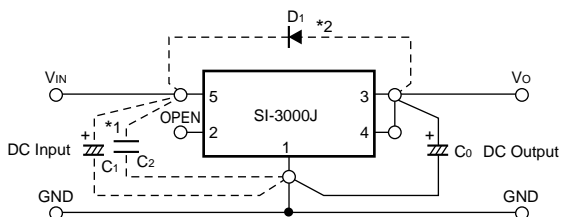

C₀ : Output capacitor (47 to 100μF)

*1 C₁ } : Oscillation prevention capacitor

C₂ } (C₁: Approx. 47μF, C₂: 0.33μF)

These capacitors are required if the input line is inductive and in the case of long wiring. Tantalum capacitors are recommended for C₁ and C₀, particularly at low temperatures.

*2 D₁ : Protection diode

This diode is required for protection against reverse biasing of the input and output. Sanken EU2Z is recommended.

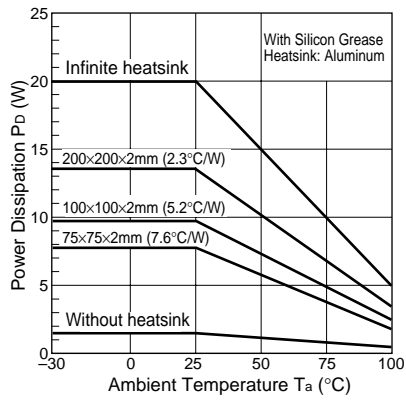
■ T_a - P_D Characteristics

$$P_D = I_o \cdot [V_{IN}(\text{mean}) - V_o]$$

External Variable Output Voltage Circuit

1. Variable output voltage with a single external resistor

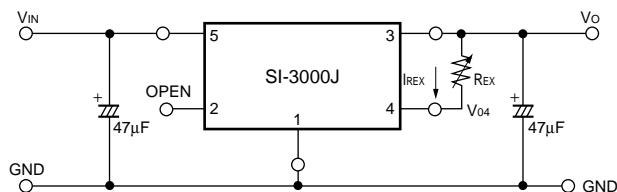

The output voltage may be increased by inserting resistor R_{EX} between terminals No.4 (sensing terminal) and No.3 (output terminal). The current I_{REX} flowing into terminal No.4 is 1mA (typ.), therefore the adjusted output voltage V_{OUT} is:

$$V_O = V_{04} + I_{REX} \cdot R_{EX} \quad *V_{04}: \text{output voltage of SI-3000J series}$$

However, the internal resistor (between terminals No. 4 and No.1) is a semiconductor resistor, which has approximately thermal characteristics of +0.2%/°C.

It is important to keep the thermal characteristics in mind when adjusting the output voltage.

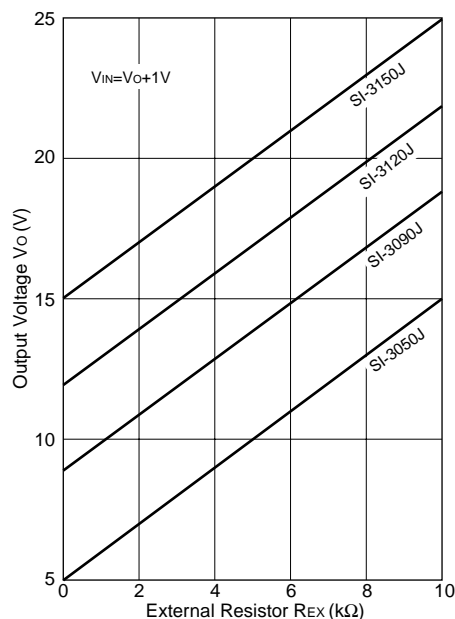

2. Variable output voltage with two external resistors

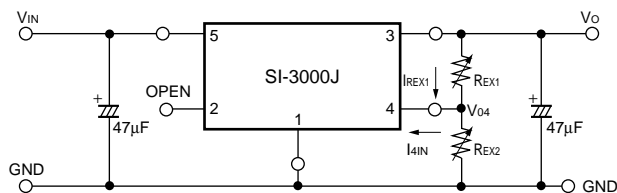

The output voltage may be increased by inserting resistors R_{EX1} between terminals No.4 (sensing terminal) and No.3 (output terminal) and R_{EX2} between terminals No.4 and No.1 (ground terminal).

The current I_{4IN} flowing into terminal No.4 is 1mA (typ.) so the thermal characteristics may be improved compared to the method shown in 1 by setting the external current I_{REX1} at approximately 5 times the value of I_{4IN} (stability coefficient $S=5$).

The adjusted output voltage V_{OUT} in this case is:

$$\begin{cases} V_O = V_{04} + R_{EX1} \cdot I_{REX1} \\ I_{REX1} = S \cdot I_{4IN} \end{cases}$$

The value of the external resistors may be obtained as follows:

$$R_{EX1} = \frac{V_O - V_{04}}{S \cdot I_{4IN}}, \quad R_{EX2} = \frac{V_{04}}{(S-1) \cdot I_{4IN}}$$

* V_{04} : Output voltage of SI-3000J series

S: Stability coefficient of I_{4IN} (may be set to any value)

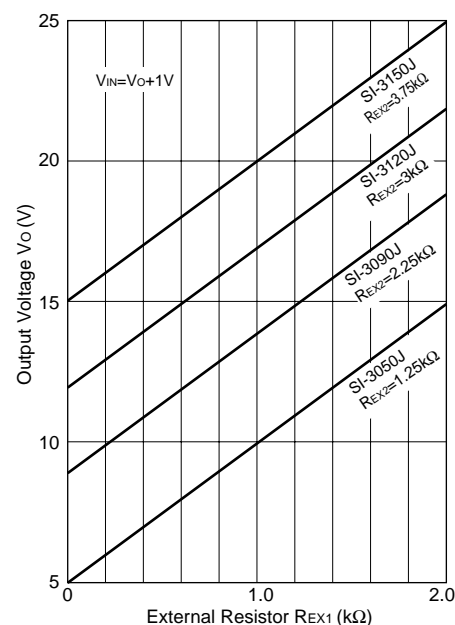

Note: In the SI-3000J series, the output voltage increase can be adjusted as mentioned above. However, when the rise is set to approximately 10V compared to output voltage V_{04} , the necessary output current may not be obtained due to the S.O.A. protection circuit in the SI-3000J series.

■Typical Characteristics

($T_a=25^\circ\text{C}$)

Io vs. VdIF Characteristics

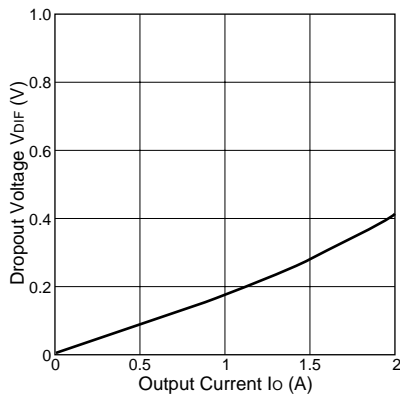

Temperature Coefficient of Output Voltage(SI-3050J)

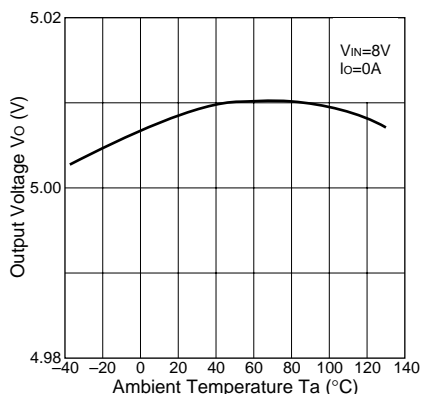

Circuit Current(SI-3050J)

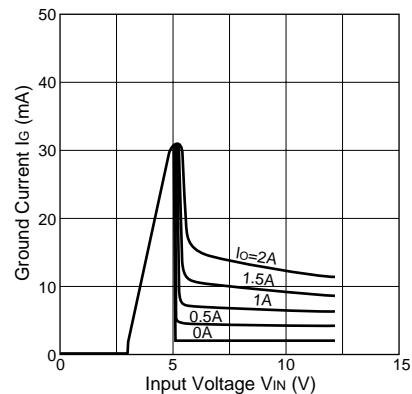

Quiescent Circuit Current(SI-3050J)

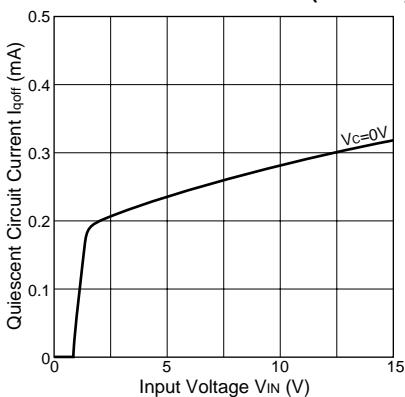

Output Voltage(SI-3050J)

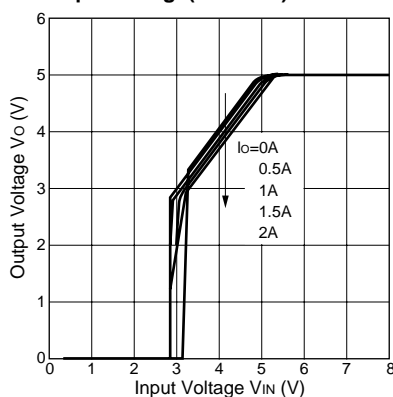

Output Voltage(SI-3120J)

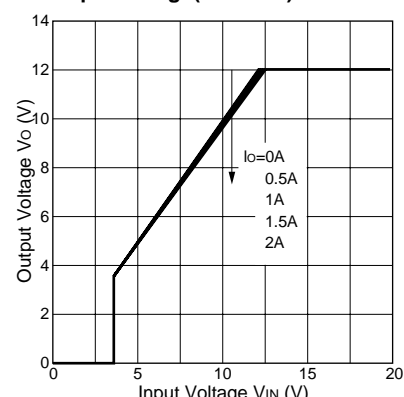

Overcurrent Protection Characteristics(SI-3050J)

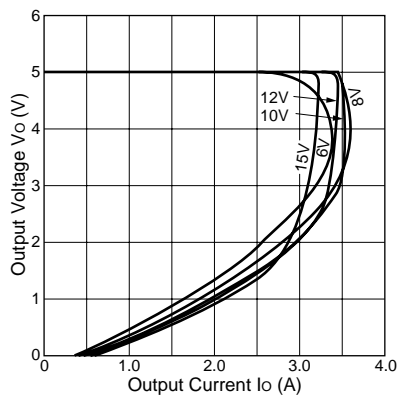

Overcurrent Protection Characteristics(SI-3120J)

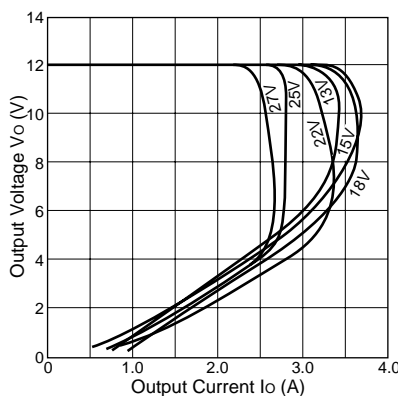

ON/OFF Control Characteristics(SI-3050J)

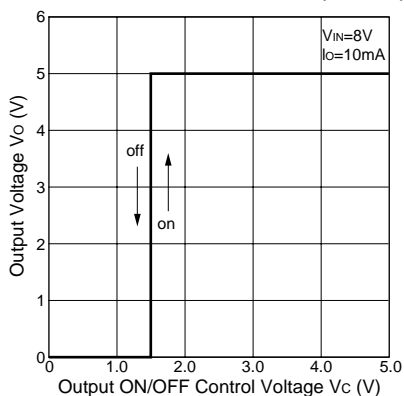

Thermal Protection(CharacteristicsSI-3050J)

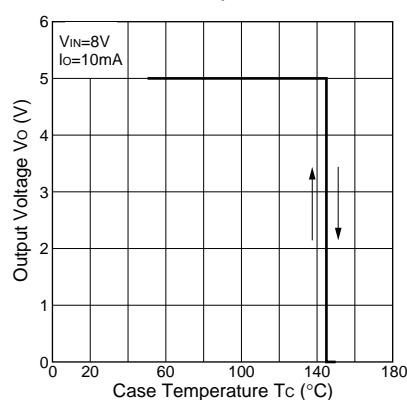

Note on Thermal Protection:

The thermal protection circuit is intended for protection against heat during instantaneous short-circuiting. Its operation is not guaranteed for continuous heating condition such as short-circuiting over extended periods of time.

SI-3000R Series

5-Terminal, Full-Mold, Low Dropout Voltage Dropper Type with Reset Function

■Features

- Reset signal output (As the output rises it sends a reset signal to the micro-computer to secure normal operation of the system. As the output drops a reset signal is also sent out to protect the system.)
- Reset signal detection output voltage level V_{oH} is 92% of output voltage in the standard specification. Models with different setting values for different needs are scheduled to be added to the series.
- Delay time for reset signal can be set freely by external capacitor.
- Compact full-mold package (equivalent to TO220)
- Output current: 1.5A
- Low dropout voltage : $V_{DIF} \leq 1V$ (at $I_o = 1.5A$)
Applicable to battery driven equipment with built-in microcomputer.
- Built-in dropping type overcurrent, overvoltage, thermal protection circuits
- Low circuit current $I_D = \text{typ.} 1.5mA (I_o = 0A)$

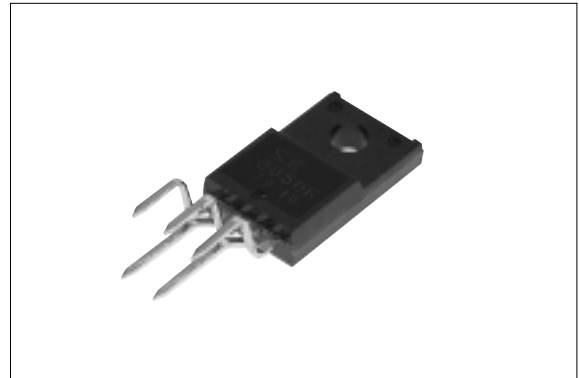

■Applications

- Microcomputer-controlled equipment
- Battery-driven micro-computer-controlled equipment

■Absolute Maximum Ratings

($T_a = 25^\circ\text{C}$)

Parameter	Symbol	Ratings		Unit
		SI-3050R		
DC Input Voltage	V_{IN}	35		V
Voltage of Rest Signal Output Terminal	V_{RST}	V_{IN}		V
DC Output Current	I_o	1.5 ¹		A
Power Dissipation	P_{D1}	18(With infinite heatsink)		W
	P_{D2}	1.5(Without heatsink, stand-alone operation)		W
Junction Temperature	T_j	-30 to +125		$^\circ\text{C}$
Ambient Operating Temperature	T_{OP}	-30 to +100		$^\circ\text{C}$
Storage Temperature	T_{stg}	-30 to +125		$^\circ\text{C}$
Thermal Resistance (junction to case)	$R_{th(j-c)}$	5.5		$^\circ\text{C/W}$
Thermal Resistance (junction to ambient air)	$R_{th(j-a)}$	66.7(Without heatsink, stand-alone operation)		$^\circ\text{C/W}$

■Electrical Characteristics

(Ta=25°C unless otherwise specified)

Parameter	Symbol	Ratings			Unit	
		SI-3050R				
		min.	typ.	max.		
Input Voltage	V _{IN}	6 ^{*2}		30 ^{*1}	V	
Output Voltage	V _O	4.80	5.00	5.20	V	
	Conditions	V _{IN} =8V, I _O =1.0A				
Dropout Voltage	V _{DIF}			0.5	V	
	Conditions	I _O ≤1.0A				
	Conditions	I _O ≤1.5A				
Line Regulation	ΔV _{OLINE}			30	mV	
	Conditions	V _{IN} =6 to 15V, I _O =1.0A				
Load Regulation	ΔV _{OLOAD}			100	mV	
	Conditions	V _{IN} =8V, I _O =0 to 1.5A				
Ripple Rejection	R _{REJ}		54		dB	
	Conditions	V _{IN} =8V, f=100 to 120Hz				
Quiescent Circuit Current	I _q		1.5	5.0	mA	
	Conditions	V _{IN} =8V, I _O =0A				
Overcurrent Protection Starting Current (Dropping Type)	I _{S1}	1.6			A	
	Conditions	V _{IN} =8V				
Limited Current at Overcurrent Protection Operation	I _{S2}	1.6			A	
	Conditions	V _{IN} =8V				
DLY Terminal	Threshold	V _{DLYth}	2.7	2.9	3.1	V
	Source	I _{DLY}	25	35	45	μA
Reset Threshold Voltage Level (V _{oth} : Threshold Output Voltage)	V _{oth} /V _O	90	92	94	%	
Reset Threshold Voltage Hysteresis	ΔV _{oth}	50	100	150	mV	
VRST Terminal ^{*4}	H-level Output Voltage	V _{RSTH}	V _{CC} -1		V	
	L-level Output Voltage	V _{RSTL}		0.8	V	
	Sink Current at H level	I _{RSTH}		-20	μA	
	Source Current at L level	I _{RSTL}	-16			mA

*1: V_{IN(max)} and I_{O(max)} are restricted by the relation P_{D(max)}=(V_{IN}-V_O)•I_O=18(W).

*2: Refer to the dropout voltage.(Refer to Setting Dc Input Voltage on page 7.)

*3: I_{S1} is specified at -5(%) drop point of output voltage V_O on the condition that V_{IN}=8V, I_O=1.0A.

*4: Reset signal output terminal VRST is an open-collector output. Use a pull-up resistor when connecting it to a logic circuit.

■Reset Signal Output Timing Chart

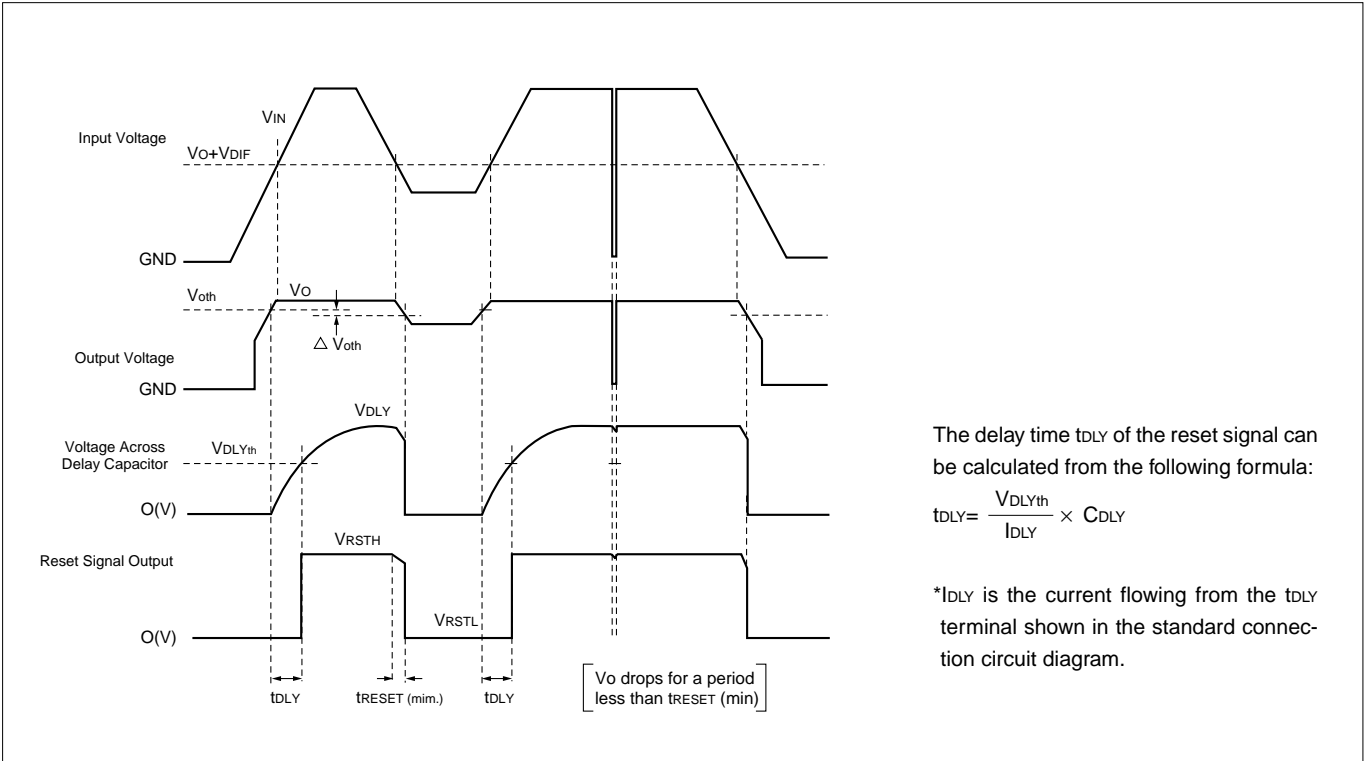

■External Dimensions

(unit:mm)

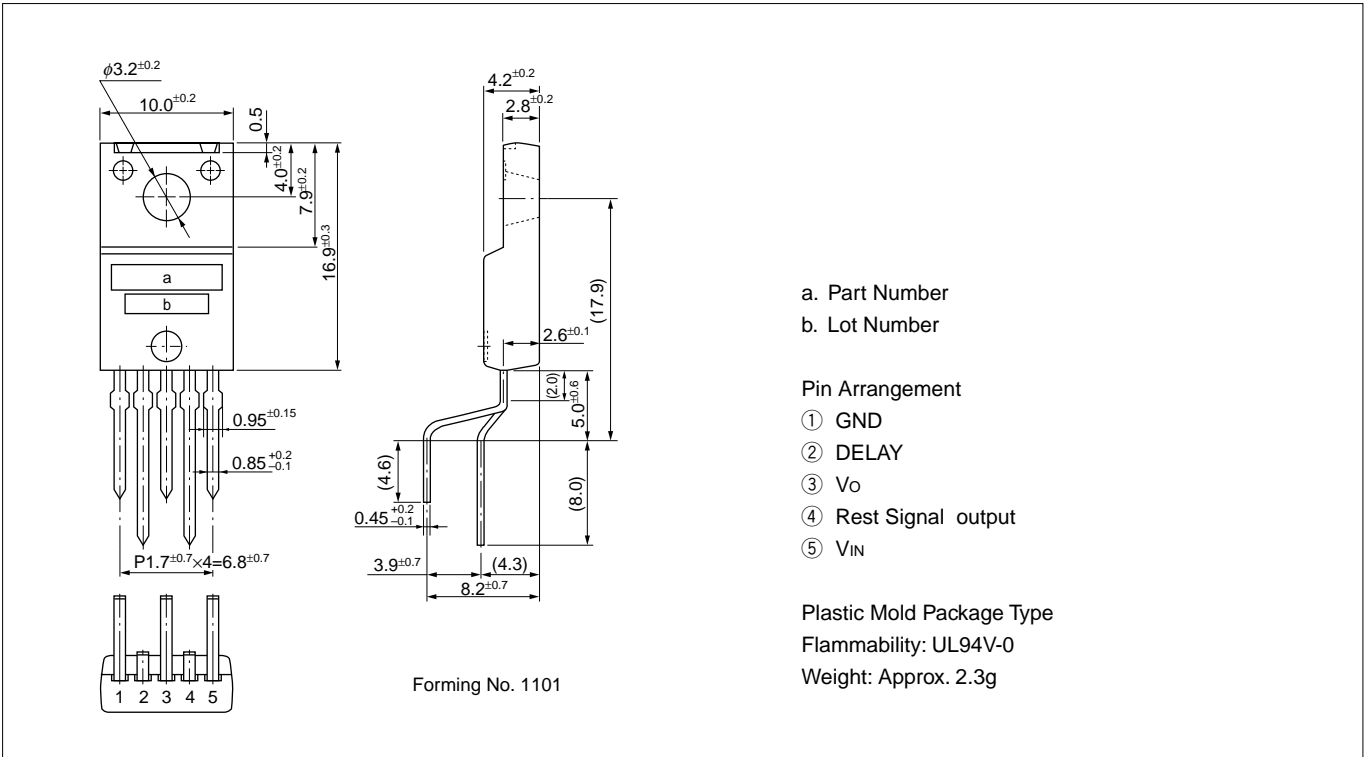

■Block Diagram

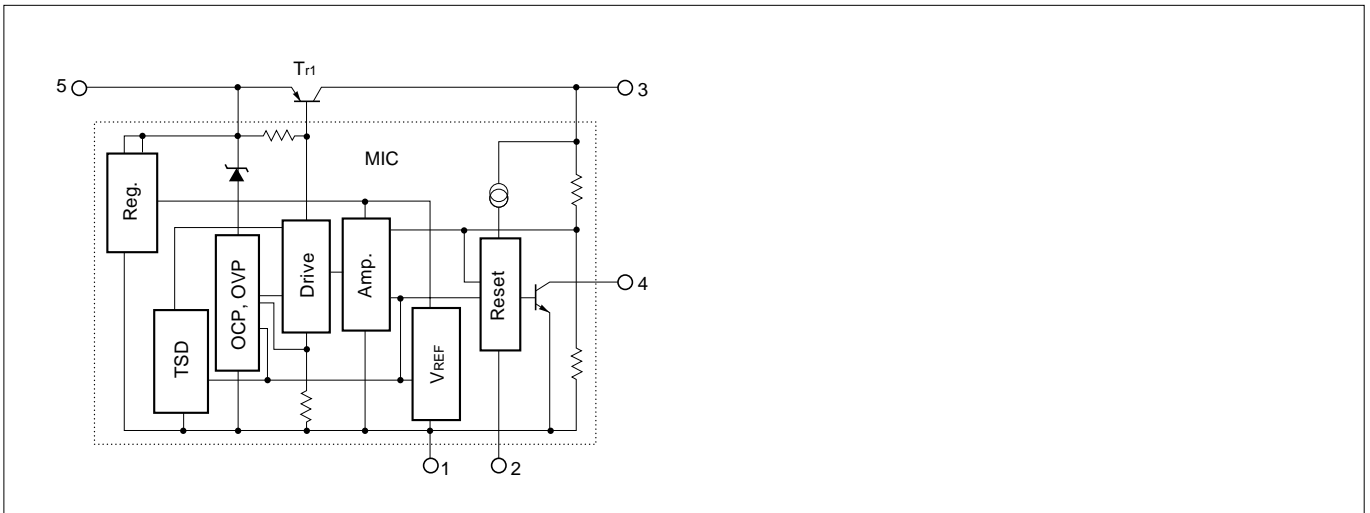

■Standard External Circuit

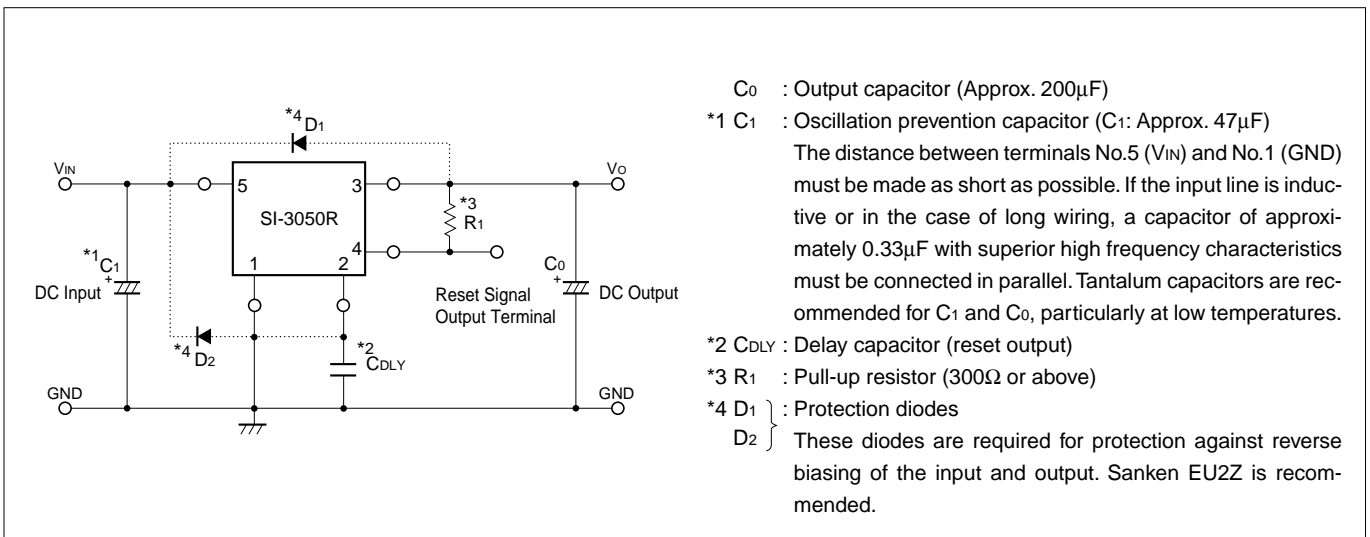

■ T_a - P_D Characteristics

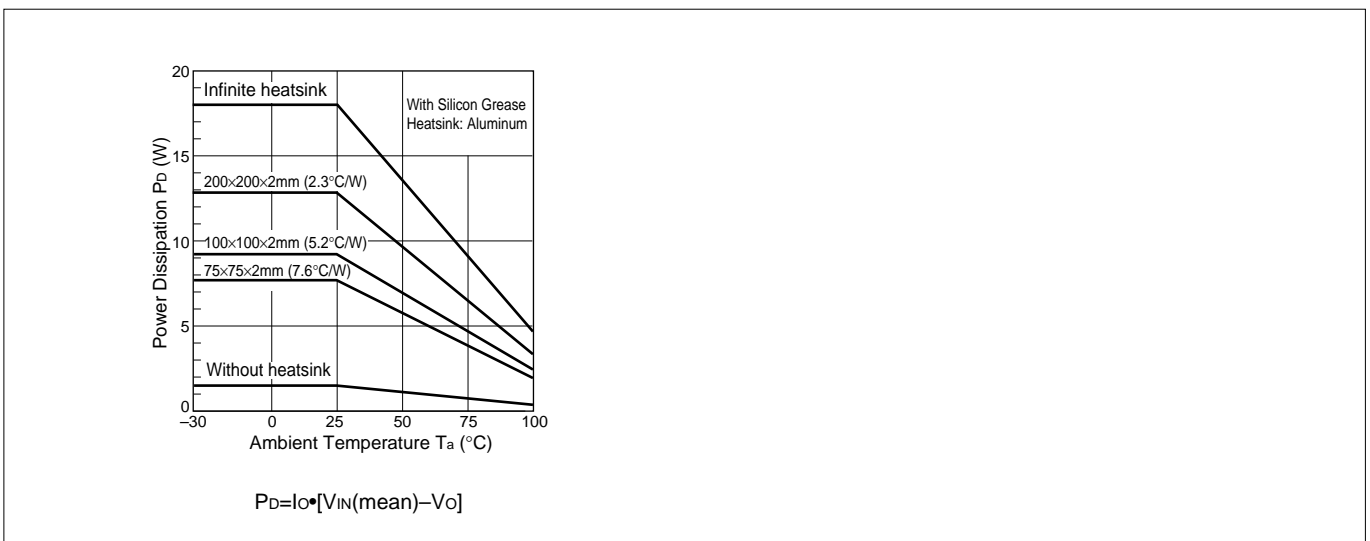

Typical Characteristics

($T_a=25^\circ\text{C}$)

Io vs. VDIF Characteristics

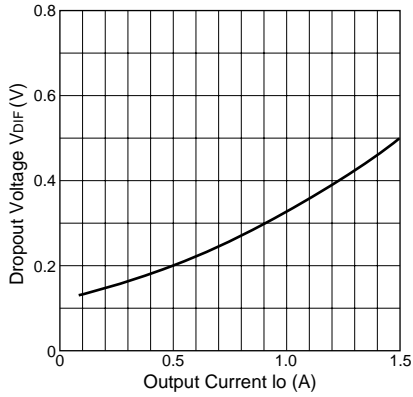

Temperature Coefficient of Output Voltage

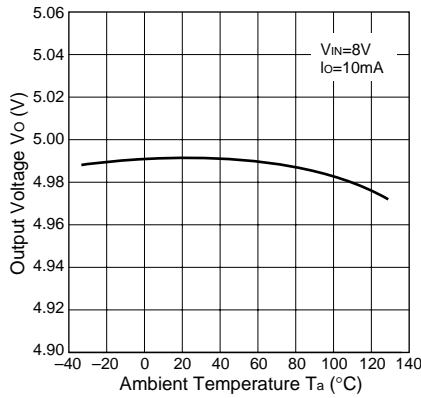

Output Voltage

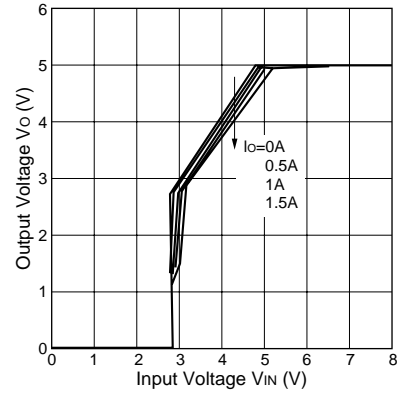

Circuit Current

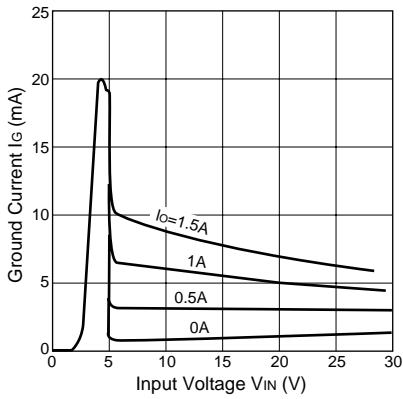

Overcurrent Protection Characteristics

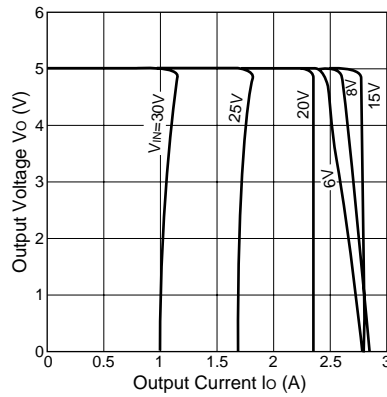

Thermal Protection Characteristics

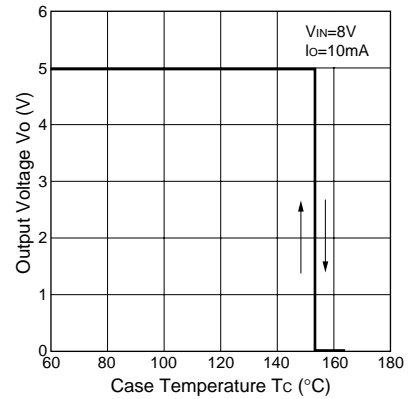

Note on Thermal Protection:

The thermal protection circuit is intended for protection against heat during instantaneous short-circuiting. Its operation is not guaranteed for continuous heating condition such as short-circuiting over extended periods of time.

Reset Output vs. Vo Characteristics

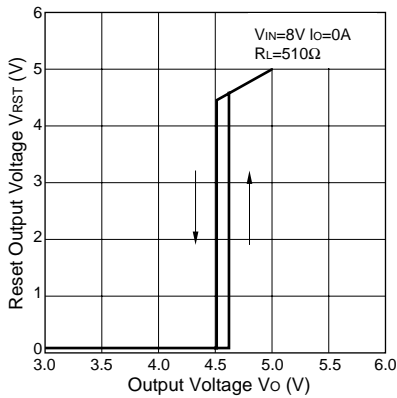

Reset Output vs. DLY Terminal Voltage Characteristics

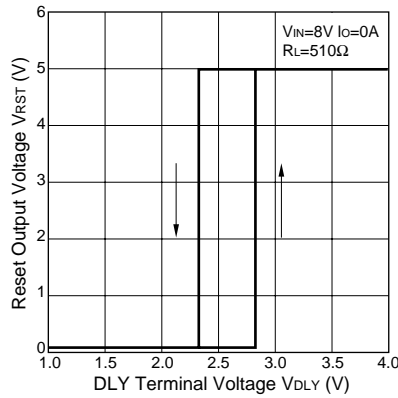

Reset Signal Delay Time tDLY(sec)

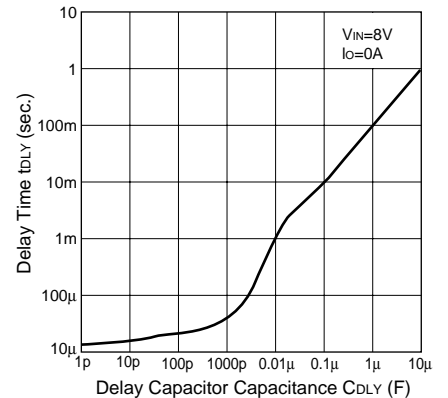

SI-3000P Series

3-Terminal, Dropper Type

■Features

- TO-3P package 3-terminal regulator
- Output current: 2.0A
- Wide range of DC input voltage
- Built-in foldback overcurrent protection circuit

■Applications

- For stabilization of the secondary stage of switching power supplies
- Electronic equipment

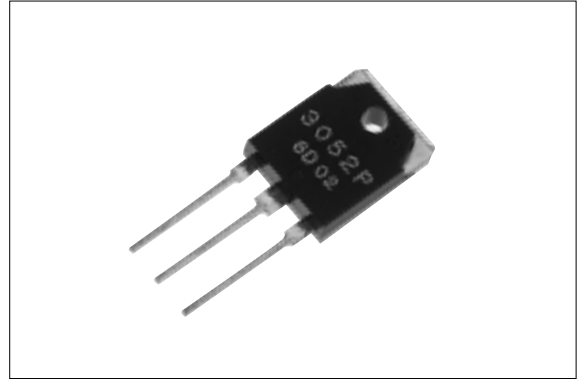

■Absolute Maximum Ratings

(Ta=25°C)

Parameter	Symbol	Ratings	Unit
DC Input Voltage	V_{IN}	45	V
DC Output Current	I_o	2.0	A
Power Dissipation	P_{D1}	50(Tc=25°C)	W
	P_{D2}	2.0(Without heatsink, stand-alone operation)	W
Junction Temperature	T_j	-30 to +125	°C
Ambient Operating Temperature	T_{op}	-20 to +80	°C
Storage Temperature	T_{stg}	-30 to +125	°C
Thermal Resistance (junction to case)	$R_{th(j-c)}$	2.0	°C/W

■Electrical Characteristics

(Ta=25°C)

Parameter	Symbol	Ratings												unit
		SI-3052P			SI-3122P			SI-3152P			SI-3242P			
		min.	typ.	max.	min.	typ.	max.	min.	typ.	max.	min.	typ.	max.	
Input Voltage	V _{IN}	8		30	15		35	18		40	27		40	V
Output Voltage	V _O	4.9	5.0	5.1	11.8	12.0	12.2	14.8	15.0	15.2	23.8	24.0	24.2	V
	Conditions	V _{IN} =10V, I _O =0.5A			V _{IN} =19V, I _O =0.5A			V _{IN} =23V, I _O =0.5A			V _{IN} =33V, I _O =0.5A			
Dropout Voltage	V _{DIF}			3			3			3			3	V
	Conditions	I _O =2.0A												
Line Regulation	ΔV _{OLINE}		2	10		10	30		10	30		25	50	mV
	Conditions	V _{IN} =8.5 to 11.5V, I _O =0.5A			V _{IN} =16 to 22V, I _O =0.5A			V _{IN} =19.5 to 26.5V, I _O =0.5A			V _{IN} =28 to 38V, I _O =0.5A			
Load Regulation	ΔV _{OLOAD}		40	100		80	200		80	200		120	300	mV
	Conditions	V _{IN} =10V, I _O =0 to 2.0A			V _{IN} =19V, I _O =0 to 2.0A			V _{IN} =23V, I _O =0 to 2.0A			V _{IN} =33V, I _O =0 to 2.0A			
Temperature Coefficient of Output Voltage	ΔV _O /ΔT _a		±0.5			±1.5			±1.5			±2.5		mV/°C
Ripple Rejection	R _{REJ}		60			60			60			60		dB
	Conditions	f=100 to 120Hz												
Overcurrent Protection Starting Current	I _{S1}	2.4			2.4			2.4			2.4			A
	Conditions	V _{IN} =10V			V _{IN} =19V			V _{IN} =23V			V _{IN} =33V			
Limited Current at Overcurrent Protection	I _{S2}			0.6			0.6			0.6			0.6	A
	Conditions	V _{IN} =10V			V _{IN} =19V			V _{IN} =23V			V _{IN} =33V			

A foldback type overcurrent protection circuit is built into the Ic regulator. Therefore, avoid using it for the following applications as it may cause starting errors:

- (1) Constant current load (2) Plus/minus power (3) Series power (4) V_O adjustment by raising ground voltage

■External Dimensions

(unit:mm)

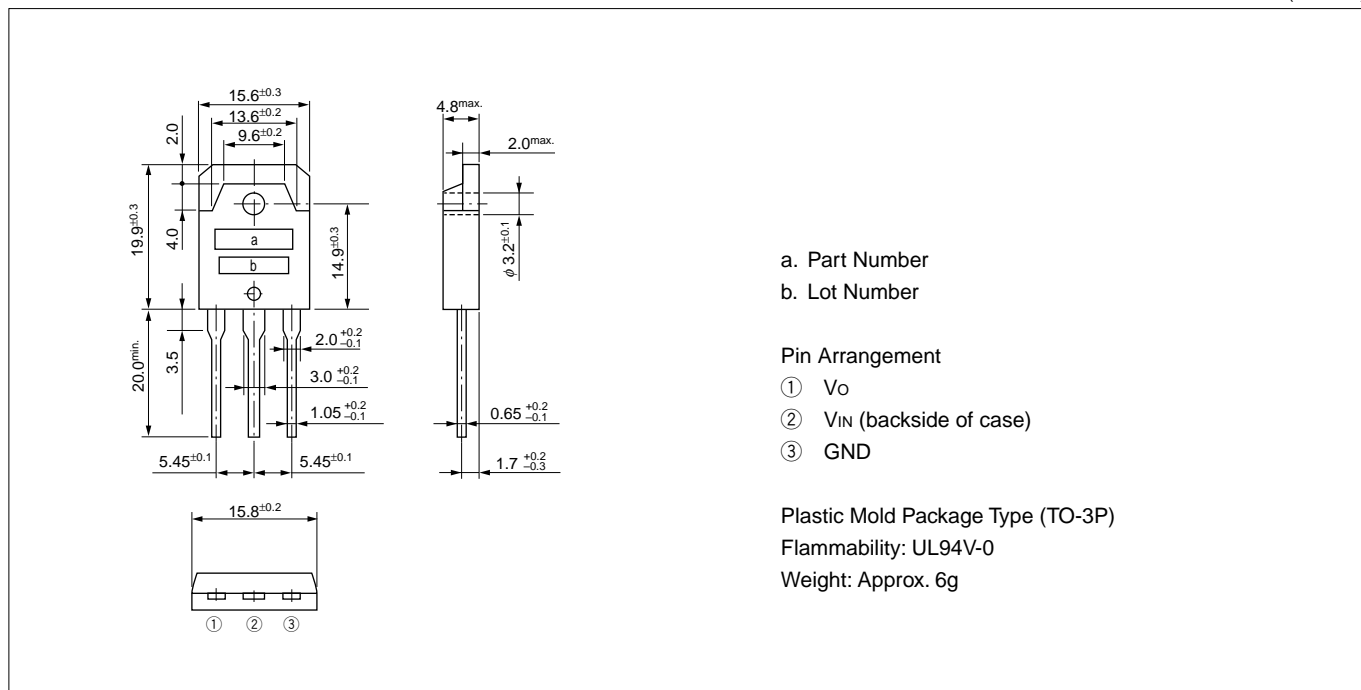

■Block Diagram

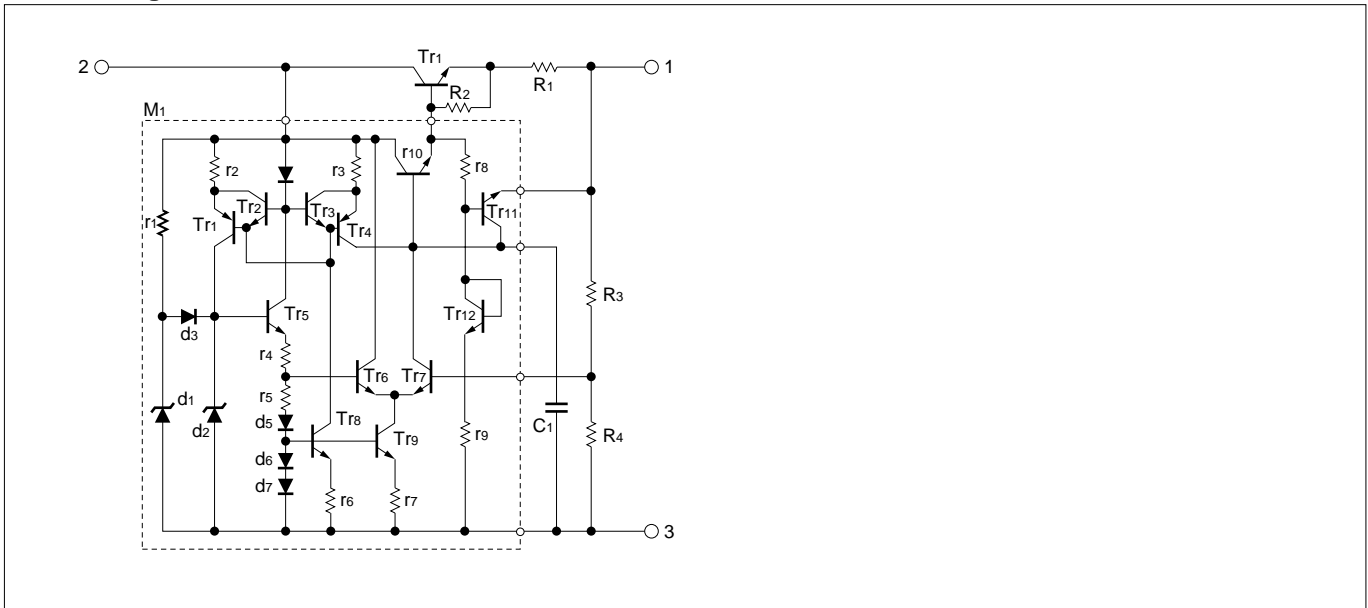

■Standard External Circuit

C1: Oscillation prevention capacitor (approx. 0.33 μ F)
Connection to terminal No.2 must be made as short as possible.

C2: Output capacitor (47 to 100 μ F)
Connection to terminal No.1 must be made as short as possible.

D1: Protection diode (RM1Z)
Required for protection against reverse biasing of input and output.

Note 1: Connect a 47 μ F to 100 μ F capacitor to both sides of the load if the wiring between the output terminal and the load is long.

Note 2: An isolation type diode is provided from input to ground and also from output to ground. These may be destroyed if the device is reverse biased. In this case, use a diode with low V_F to protect them.

Note 3: The output voltage may not be adjusted by raising the ground voltage (using a diode or resistor).

■ T_a - P_D Characteristics

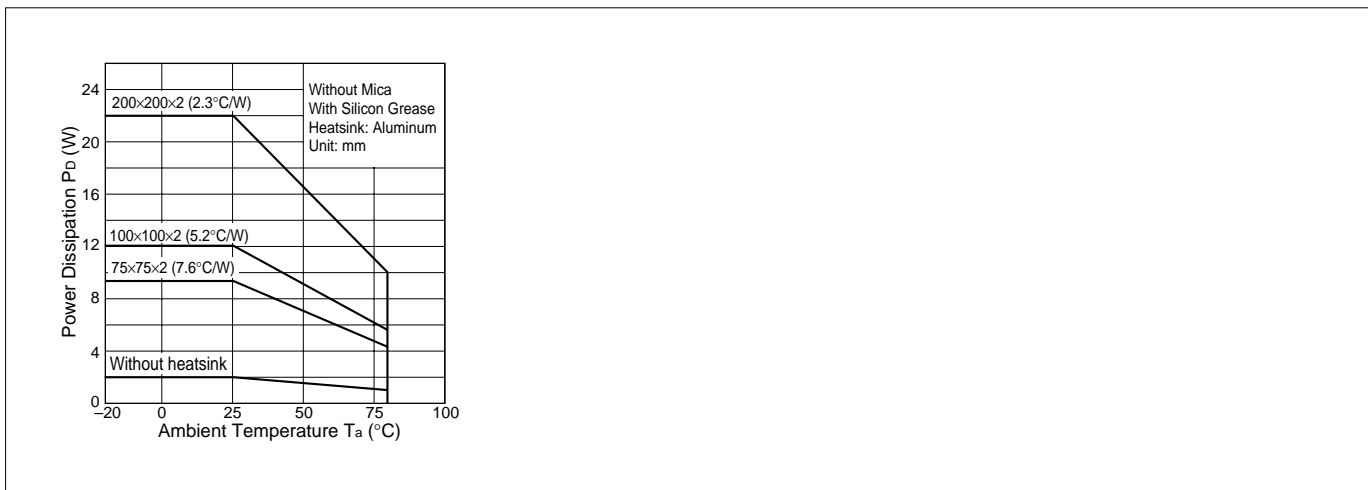

■Typical Characteristics

($T_a=25^\circ\text{C}$)

I_o vs. V_{DIF} Characteristics

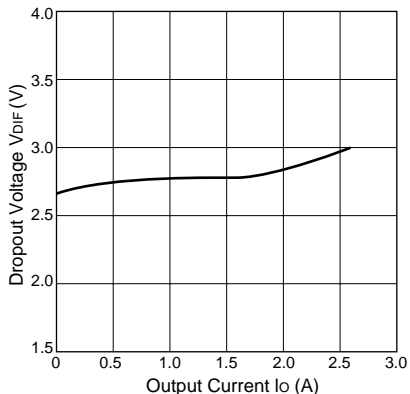

Temperature Coefficient of Output Voltage(SI-3052P)

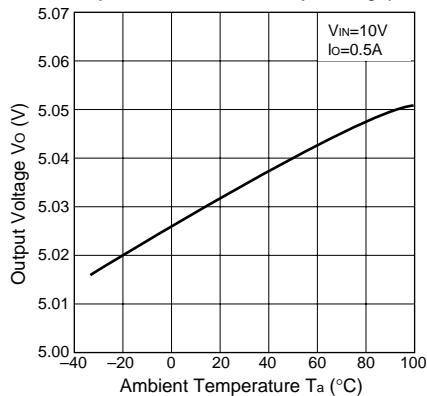

Circuit Current(SI-3052P)

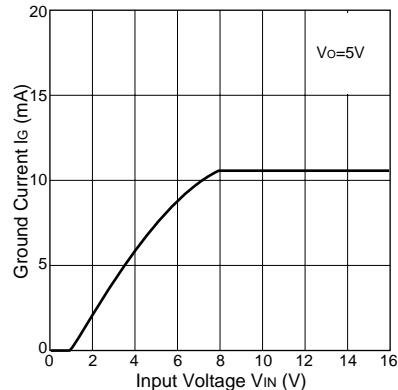

Output Voltage(SI-3052P)

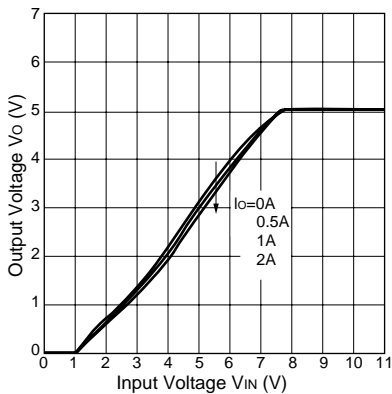

Output Voltage(SI-3122P)

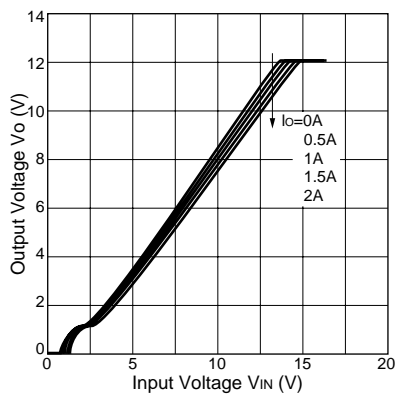

Output Voltage(SI-3242P)

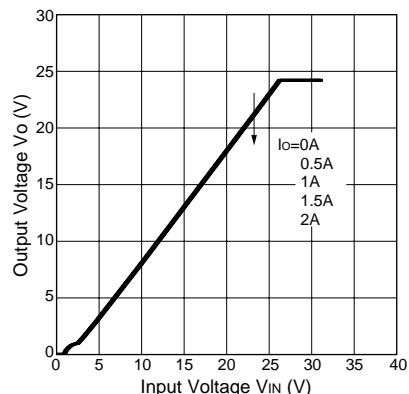

Overcurrent Protection Characteristics(SI-3052P)

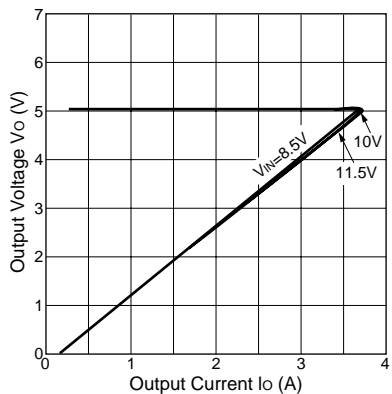

Overcurrent Protection Characteristics(SI-3122P)

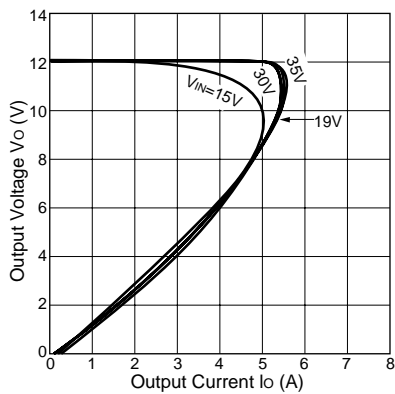

Overcurrent Protection Characteristics(SI-3242P)

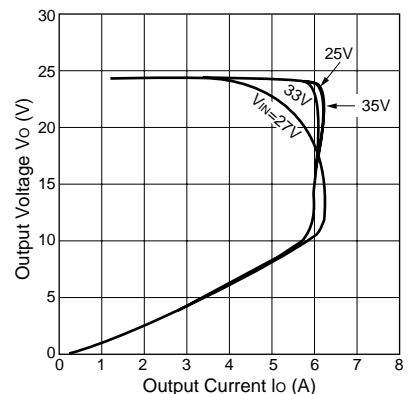

SI-3000V Series

3-Terminal, Low Dropout Voltage Dropper Type

■Features

- TO-3P package 3-terminal regulator
- Output current: 2.0A
- Low dropout voltage: $V_{DIF} \leq 1V$ (at $I_o = 2.0A$)
- Built-in foldback overcurrent protection circuit

■Applications

- For stabilization of the secondary stage of switching power supplies
- Electronic equipment

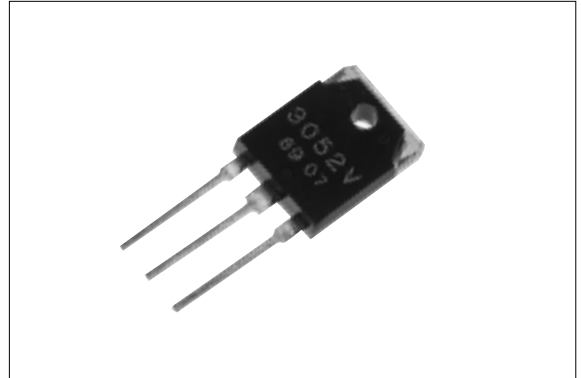

■Absolute Maximum Ratings

($T_a = 25^\circ C$)

Parameter	Symbol	Ratings		Unit
		SI-3052V	SI-3122V/3152V	
DC Input Voltage	V_{IN}	25	30	V
DC Output Current	I_o	2.0		A
Power Dissipation	P_{D1}	50($T_c = 25^\circ C$)		W
	P_{D2}	1.6(Without heatsink, stand-alone operation)		W
Junction Temperature	T_j	-30 to +125		$^\circ C$
Ambient Operating Temperature	T_{op}	-20 to +100		$^\circ C$
Storage Temperature	T_{stg}	-30 to +125		$^\circ C$
Thermal Resistance (junction to case)	$R_{th(j-c)}$	2.0		$^\circ C/W$

■Electrical Characteristics

(Ta=25°C)

Parameter	Symbol	Ratings									unit
		SI-3052V			SI-3122V			SI-3152V			
		min.	typ.	max.	min.	typ.	max.	min.	typ.	max.	
Input Voltage	V _{IN}	6		15	13		25	16		25	V
Output Voltage	V _O	4.9	5.0	5.1	11.8	12.0	12.2	14.8	15.0	15.2	V
	Conditions	V _{IN} =8V, I _O =1.0A			V _{IN} =16V, I _O =1.0A			V _{IN} =20V, I _O =1.0A			
Dropout Voltage	V _{DIF}			0.5			0.5			0.5	V
	Conditions	I _O =1.0A									
	Conditions			1.0			1.0			1.0	
Line Regulation	ΔV _{OLINE}		10	30		20	60		20	60	mV
	Conditions	V _{IN} =6 to 15V, I _O =1.0A			V _{IN} =13 to 25V, I _O =1.0A			V _{IN} =16 to 25V, I _O =1.0A			
Load Regulation	ΔV _{OLOAD}		40	100		80	200		80	200	mV
	Conditions	V _{IN} =8V, I _O =0 to 2.0A			V _{IN} =16V, I _O =0 to 2.0A			V _{IN} =20V, I _O =0 to 2.0A			
Temperature Coefficient of Output Voltage	ΔV _O /ΔT _a		±0.5			+1.5			±1.5		mV/°C
Ripple Rejection	R _{REJ}		54			54			54		dB
	Conditions	f=100 to 120Hz									
Overcurrent Protection Starting Current	I _{S1}	2.4			2.4			2.4			A
	Conditions	V _{IN} =8V			V _{IN} =16V			V _{IN} =20V			

The following are also available: SI-3522V(5.2V), SI-3062V(6V), SI-3082V(8V), SI-3922V(9.2V), SI-3102V(10V), SI-3132V(13.1V), SI-3182V(18V), SI-3202V(20V).

*: A foldback type overcurrent protection circuit is built into the I_C regulator. Therefore, avoid using it for the following applications as it may cause starting errors:

- (1) Constant current load (2) Plus/minus power (3) Series power (4) V_O adjustment by raising ground voltage

■External Dimensions

(unit:mm)

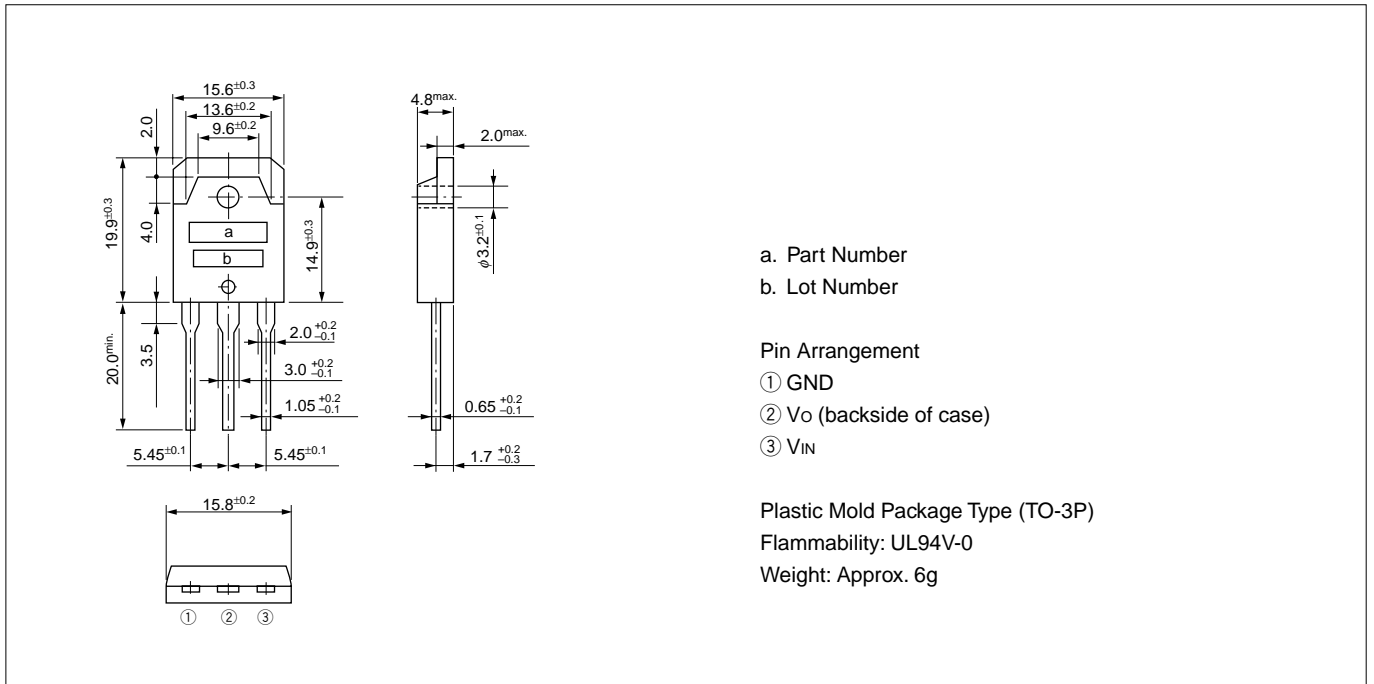

■Block Diagram

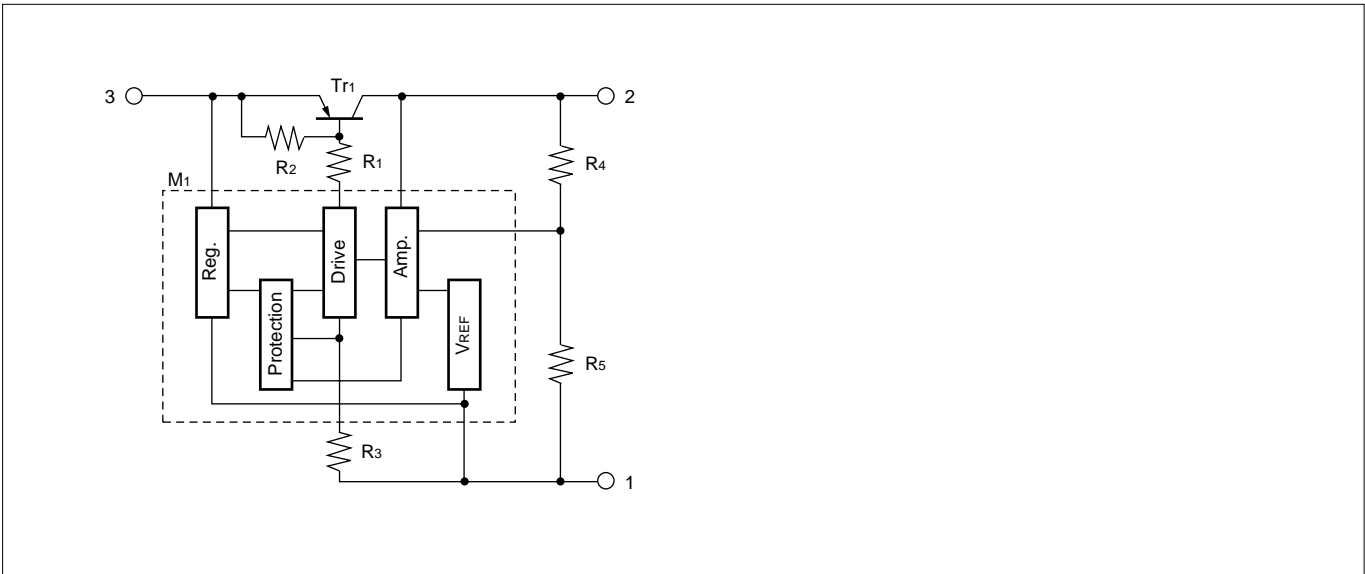

■Standard External Circuit

C1: Oscillation prevention capacitor (approx. 0.33 μ F)
 Connection to terminal No.3 must be made as short as possible.

C2: Output capacitor (47 to 100 μ F)
 Connection to terminal No.2 must be made as short as possible.

D1: Protection diode (RM1Z)
 Required for protection against reverse biasing of input and output.

Note 1: Prevention of oscillation at low temperatures
 At low temperatures, oscillation may occur unless an output capacitor with good $\tan\delta$ is used. Be sure to connect a tantalum capacitor (approx. 10 μ F) in parallel with output capacitor C2.

Note 2: An isolation type diode is provided from input to ground and also from output to ground. These may be destroyed if the device is reverse biased. In this case, use a diode with low V_F to protect them.

Note 3: The output voltage may not be adjusted by raising the ground voltage (using a diode or resistor).

■ T_a - P_D Characteristics

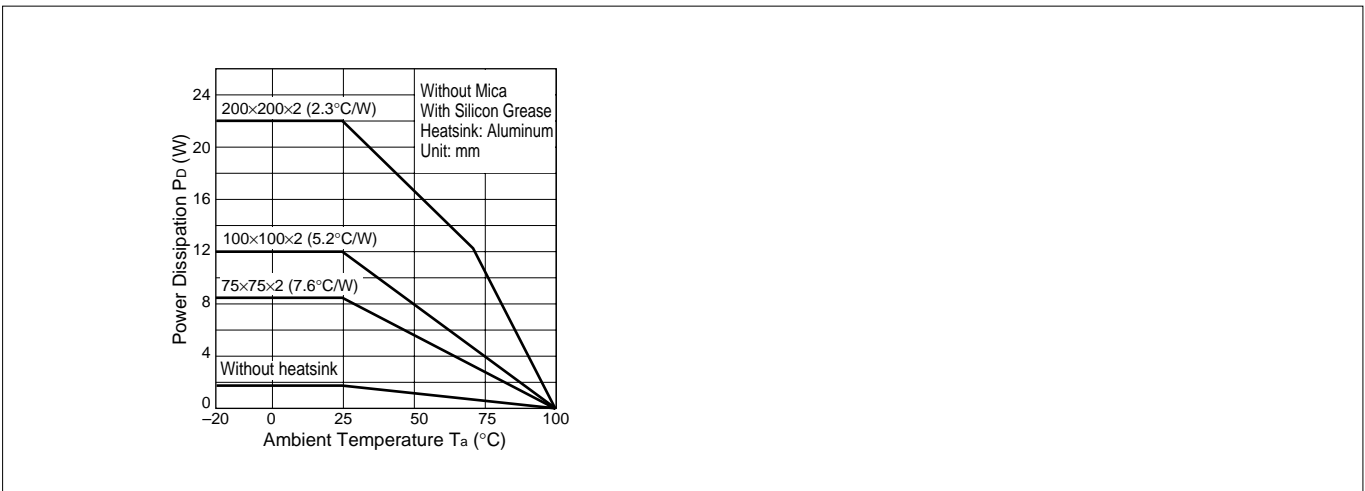

■Typical Characteristics

($T_a=25^{\circ}\text{C}$)

I_o vs. V_{DIF} Characteristics

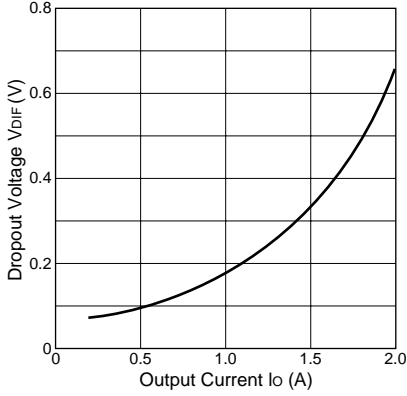

Temperature Coefficient of Output Voltage(SI-3052V)

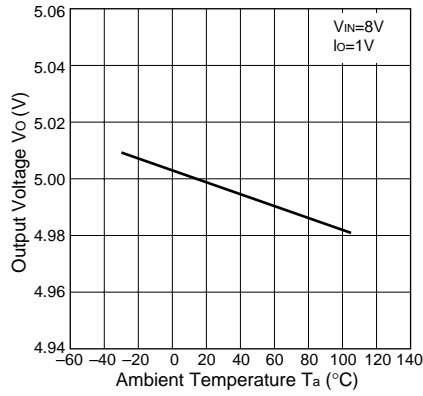

Circuit Current(SI-3052V)

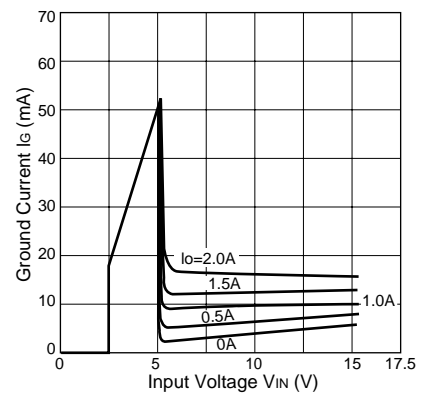

Output Voltage(SI-3052V)

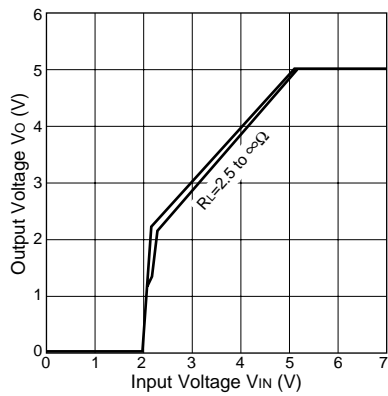

Output Voltage(SI-3122V)

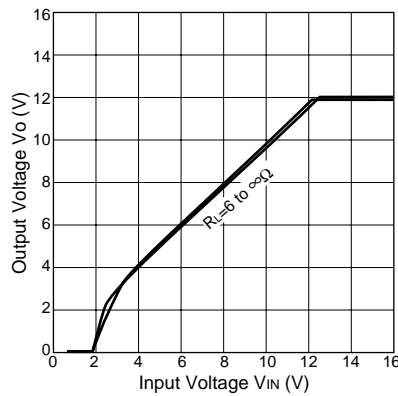

Output Voltage(SI-3152V)

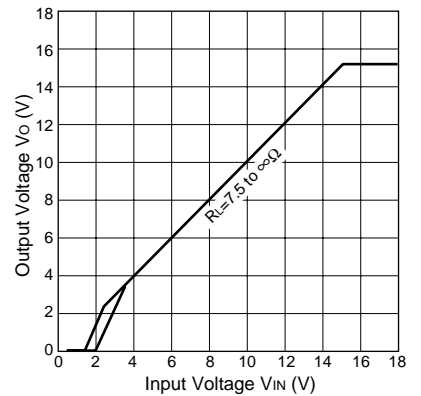

Overcurrent Protection Characteristics(SI-3052V)

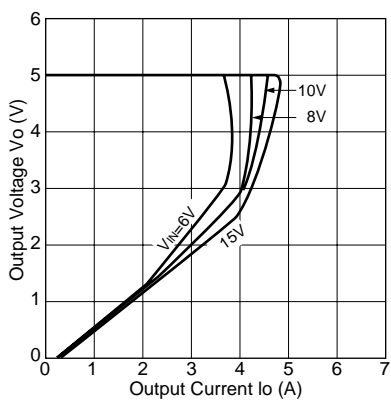

Overcurrent Protection Characteristics(SI-3122V)

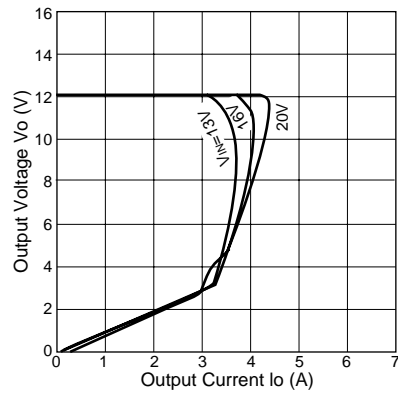

Overcurrent Protection Characteristics(SI-3152V)

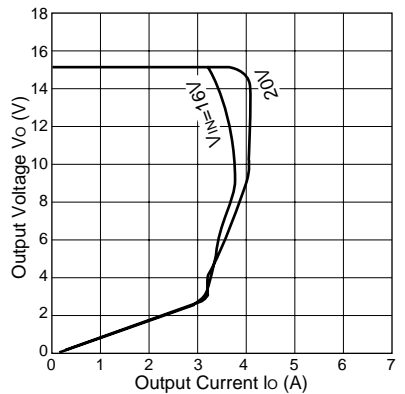

Switching Type - Application Note

Temperature and Reliability

The reliability of an IC is highly dependent on its operating temperature. Design should pay particular attention to ensuring ample space for radiating heat.

Be sure to apply silicon grease to the IC before attaching a heatsink, and to secure it firmly to the heatsink. Allow sufficient margin when designing the heatsink.

Other important items to be considered regarding heat radiation include air convection during operation.

The reliability of peripheral components such as capacitors and coils is closely related to temperature. A high operating temperature may reduce the service life. Exceeding the allowable temperature may burn the coils or damage capacitors. It is important to make sure that the temperature of output smoothing coils and input/output capacitors do not exceed their allowable levels during operation. Allow for variation in the ratings of the coils and minimize heat emission as far as possible. (For peripheral components, refer to the user manuals.)

Internal Power Dissipation

P_D can be obtained from the following formula.

- With built-in flywheel diode:

(SI-8000L series)

$$P_D = V_o \cdot I_o \left(\frac{100}{\eta_x} - 1 \right)$$

- With external flywheel diode:

(SAI series, SI-8000E series, SI-8000S series)

$$P_D = V_o \cdot I_o \left(\frac{100}{\eta_x} - 1 \right) - V_F \cdot I_o \left(1 - \frac{V_o}{V_{IN}} \right)$$

Efficiency η_x depends on the input/output conditions. The efficiency characteristics of each product type are provided for reference purposes.

V_o : Output voltage

V_{IN} : Input voltage

I_o : Output current

η_x : Efficiency(%)

V_F : Diode forward voltage

Heatsink Design

The maximum junction temperature $T_{j(max)}$ given in the absolute maximum ratings is specific to each product type and must be strictly observed. Thus, thermal design must consider the conditions of use which affect the maximum power dissipation $P_{D(max)}$ and the maximum ambient temperature $T_{a(max)}$.

To simplify thermal design, the relationship between these two parameters has been presented in a graph, the T_a - P_D characteristic graph. Thermal design should include these steps:

1. Obtain the maximum ambient temperature $T_{a(max)}$.
2. Obtain the maximum power dissipation $P_{D(max)}$.
3. Look for the intersection point on the T_a - P_D characteristic graph and determine the size of the heatsink.

The size of the heatsink has now been obtained. However, in actual applications, a 10 to 20% derating factor is introduced. Moreover, the heat dissipation capacity of a heatsink highly depends on how it is mounted. Thus, it is recommended to measure the heatsink and case temperature in the actual operating environment.

The T_a - P_D characteristics for each product type are provided for reference purposes.

Fastening Torque

SI-8000E]	0.588 to 0.686[N•m] (6.0 to 7.0[kgf•cm])
SI-8000S		

Recommended Silicon Grease

- Shin-Etsu Chemical Co., Ltd.: G746
- GE Toshiba Silicone Co., Ltd.: YG-6260
- Dow Corning Toray Silicone Co., Ltd.: SC102

Please be careful when selecting silicone grease since the oil in some grease may penetrate the product, which will result in an extremely short product life.

Others

- Parallel operation can not be performed for increasing current.
- This type IC regulators can not be used for boosting current and raising voltage.

Rectifier Diodes for Power Supplies

To rectify the AC input using rectifier diodes in power supplies, use any of the SANKEN rectifier diodes shown in the following list. (Use axial type diodes in a center-tap or bridge configuration.)

Regulator Type	Diodes
SAI Series	SFPM-62(Surface-Mount Type, V_{RM} :200V, I_o :1.0A)
SI-8000E Series	AM01Z(Axial Type, V_{RM} :200V, I_o :1.0A)
SI-8200L Series	
SI-8400L Series	
SI-8000S Series	RM 4Z(Axial Type, V_{RM} :200V, I_o :3.0A) RBV-402(Bridge Type, V_{RM} :200V, I_o :4.0A)
SI-8300L Series	RM10Z(Axial Type, V_{RM} :F200V, I_o :1.5A)
SI-8500L Series,	
SI-8800L Series	AM01Z(Axial Type, V_{RM} :200V, I_o :1.0A)
SI-8900L Series	

SAI Series

Surface-Mount, Separate Excitation Switching Type

Features

- Surface-mount package
- Output current: 0.4 to 0.5A
- High efficiency: 75 to 89%
- Requires only 4 external components
- Phase correction and output voltage adjustment performed internally
- Built-in reference oscillator (60kHz)
- Built-in overcurrent and thermal protection circuits

Applications

- Power supplies for telecommunication equipment
- Onboard local power supplies



Lineup

Part Number	SAI01	SAI02	SAI03	SAI04	SAI06
Vo(V)	5.0	3.3	12.0	15.0	9.0
Io(A)	0.5		0.4		

Absolute Maximum Ratings

Parameter	Symbol	Ratings	Unit
DC Input Voltage	V _{IN}	35	V
Power Dissipation	P _D	0.75	W
Junction Temperature	T _j	+125	°C
Storage Temperature	T _{stg}	-40 to +125	°C
SW Terminal Applied Reverse Voltage	V _{sw}	-1	V
Thermal Resistance(junction to case)	R _{th(j-c)}	20	°C/W

Recommended Operating Conditions

Parameter	Symbol	Ratings					Unit
		SAI01	SAI02	SAI03	SAI04	SAI06	
DC Input Voltage Range	V _{IN}	7 to 33	5.3 to 28	15 to 33	18 to 33	12 to 33	V
Output Current Range	I _o	0 to 0.5		0 to 0.4			A
Operating Junction Temperature Range	T _{jop}	-30 to +125					°C

Electrical Characteristics

(Ta=25°C)

Parameter	Symbol	Ratings															Unit
		SAI01			SAI02			SAI03			SAI04			SAI06			
		min.	typ.	max.	min.	typ.	max.	min.	typ.	max.	min.	typ.	max.	min.	typ.	max.	
Output Voltage	Vo	4.80	5.00	5.20	3.17	3.30	3.43	11.40	12.00	12.60	14.25	15.00	15.75	8.55	9.00	9.45	V
	Conditions	VIN=20V, Io=0.3A			VIN=15V, Io=0.3A			VIN=24V, Io=0.3A			VIN=27V, Io=0.3A			VIN=21V, Io=0.3A			
Efficiency	η		80			75			88			89			86		%
	Conditions	VIN=20V, Io=0.3A			VIN=15V, Io=0.3A			VIN=24V, Io=0.3A			VIN=27V, Io=0.3A			VIN=21V, Io=0.3A			
Switching Frequency	f		60			60			60			60			60		kHz
	Conditions	VIN=20V, Io=0.3A			VIN=15V, Io=0.3A			VIN=24V, Io=0.3A			VIN=27V, Io=0.3A			VIN=21V, Io=0.3A			
Line Regulation	ΔV _{OLINE}		80	100		60	80		100	130		100	130		90	110	mV
	Conditions	VIN=10 to 30V, Io=0.3A			VIN=8 to 28V, Io=0.3A			VIN=18 to 30V, Io=0.3A			VIN=21 to 30V, Io=0.3A			VIN=15 to 30V, Io=0.3A			
Load Regulation	ΔV _{OLOAD}		30	40		20	30		70	95		90	120		50	80	mV
	Conditions	VIN=20V, Io=0.1 to 0.4A			VIN=15V, Io=0.1 to 0.4A			VIN=24V, Io=0.1 to 0.4A			VIN=27V, Io=0.1 to 0.4A			VIN=21V, Io=0.1 to 0.4A			
Temperature Coefficient of Output Voltage	ΔVo/ΔTa		±0.5			±0.5			±1.5			±1.5			±1.0		mV/°C
Ripple Rejection	R _{REJ}		45			45			45			45			45		dB
	Conditions	f=100 to 120Hz			f=100 to 120Hz			f=100 to 120Hz			f=100 to 120Hz			f=100 to 120Hz			
Overcurrent Protection Starting Current	Is1	0.55			0.55			0.45			0.45			0.45			A
	Conditions	VIN=10V			VIN=8V			VIN=18V			VIN=21V			VIN=15V			

External Dimensions

(unit: mm)

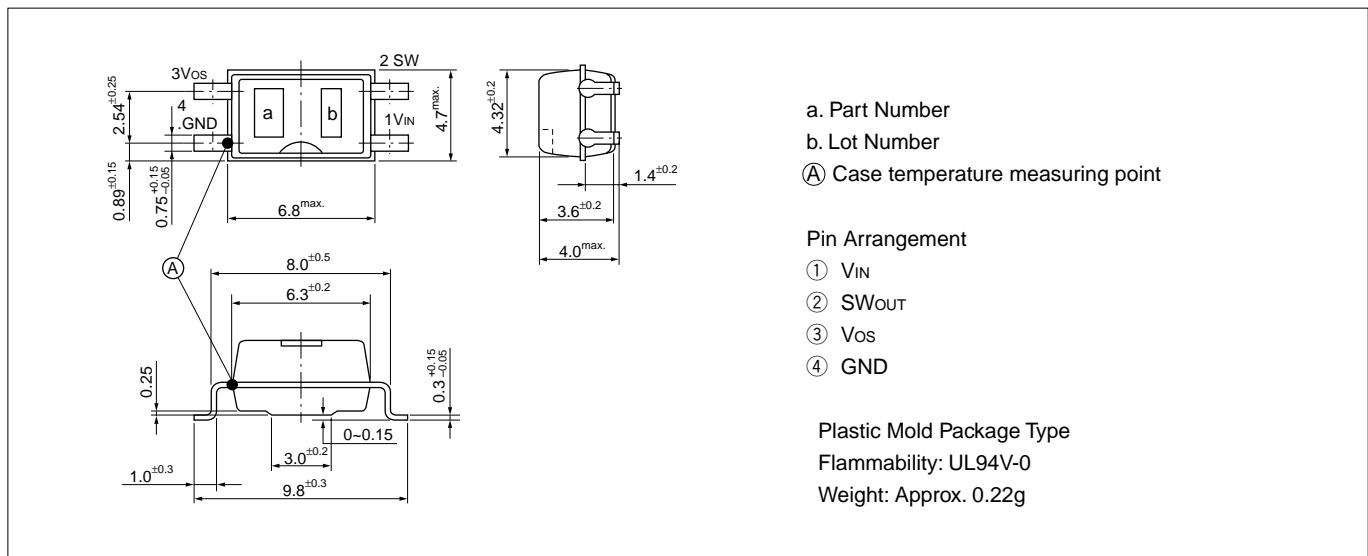

Block Diagram

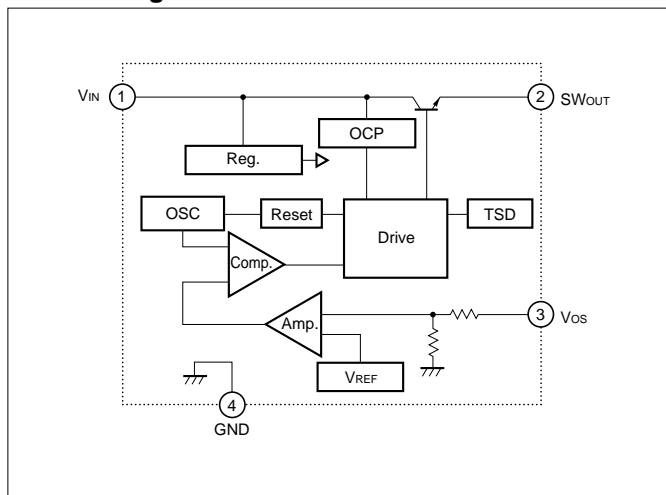

Standard External Circuit

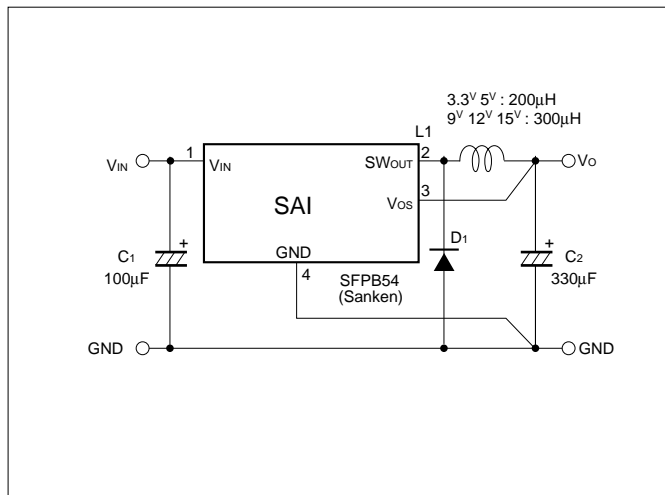

■Example of Printed Circuit Board

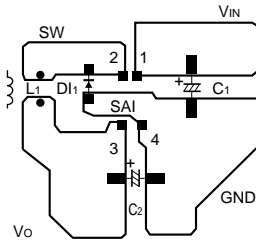

- a) For optimum operation, there must be only one GND line originating from terminal 4 and each component must be connected with the shortest possible wiring.
- b) To prevent heating of the IC, it is best to make the GND pattern as large as possible since the internal frame and terminal 4 (GND) are connected to each other.

■Ta-Pd Characteristics

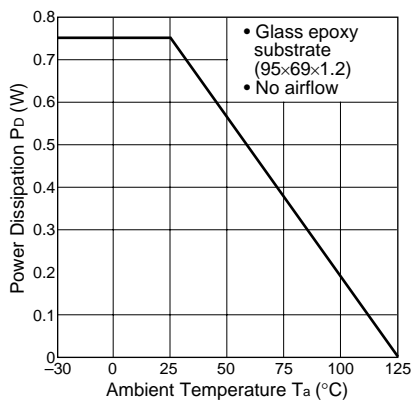

$$P_D = V_o \cdot I_o \left(\frac{100}{\eta \chi} - 1 \right) - V_F \cdot I_o \left(1 - \frac{V_o}{V_{IN}} \right)$$

The efficiency depends on the input voltage and the output current. Thus, obtain the value from the efficiency graph on page 67 and substitute the percentage in the formula above.

- Vo: Output voltage
 - Io : Output current
 - ηχ: Efficiency (%)
 - Vf : Diode forward voltage
- SFPB54-0.3V

Thermal design for D1 must be considered separately.

■Selecting External Components

1. Inductor L1

- 1) It must be suited for switching regulators.
Do not use inductors such as noise filters, because they generate excessive heat.
- 2) It must have the appropriate inductance value.
If the inductance is too small (150μH or lower), abnormal oscillation may occur causing operation problems in the overcurrent protection circuit within the rated current range.
- 3) The rated current must be satisfied.
If the rated current is exceeded, magnetic saturation leads to overcurrent.

2. Capacitors C1 and C2

- 1) They must satisfy the breakdown voltage and allowable ripple current.
Exceeding the ratings of these capacitors or using them without derating shortens their service lives and may also cause abnormal oscillation of the IC.
- 2) C2 should be a low-impedance type capacitor.
A low-impedance type capacitor is recommended for C2 to ensure reduced ripple voltage and stable switching operation.

3. Diode D1

The Sanken SFPB54 diode is recommended for D1. If you intended to use an equivalent diode, be sure to use a Schottky Barrier diode and make sure that the reverse voltage applied to terminal 2 of the IC does not exceed the value (-1V) given in the absolute maximum ratings. If you use a fast recovery diode or any other diode, supplying a reverse voltage generated from the recovery or ON voltage of the diode may damage the IC.

Application

Variable output voltage

Output voltage can be adjusted in the same way as SI-8000S in page 77.

Typical Characteristics

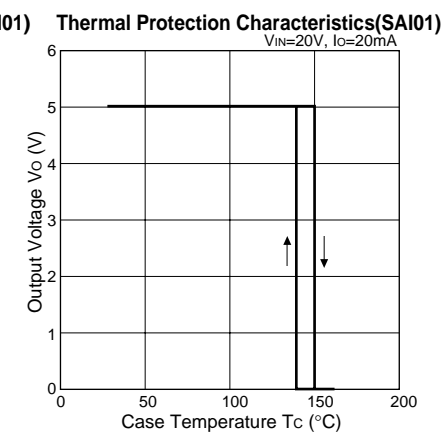
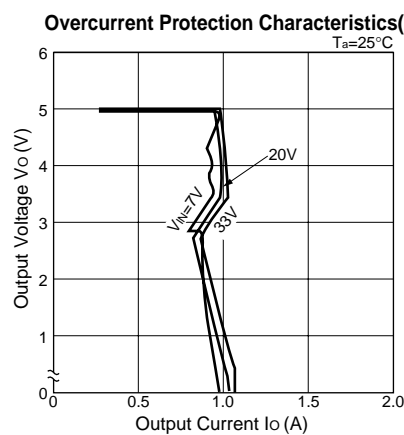
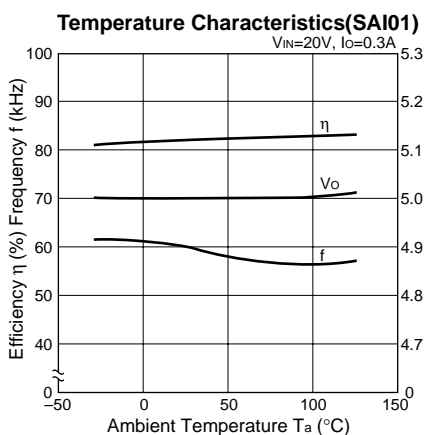
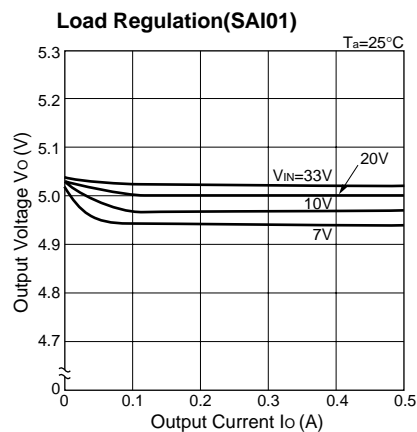
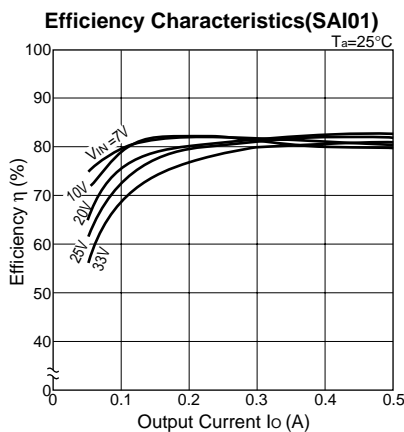
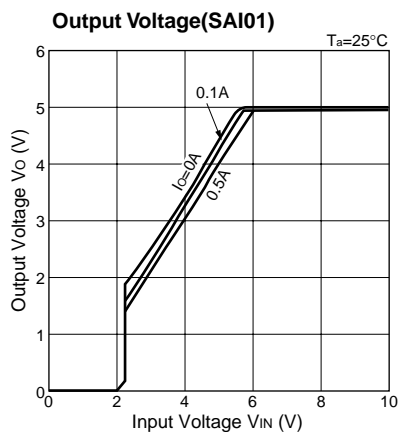

Note on Thermal Protection:
The thermal protection circuit is intended for protection against heat during instantaneous short-circuiting. Its operation is not guaranteed for continuous heating condition such as short-circuiting over extended periods of time.

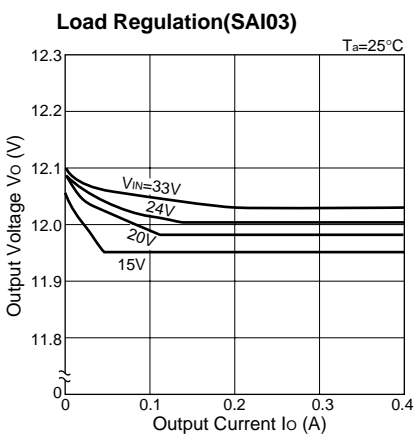
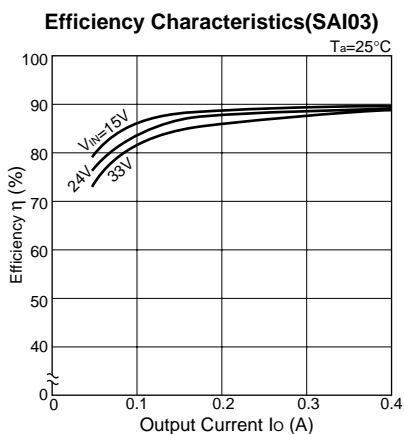
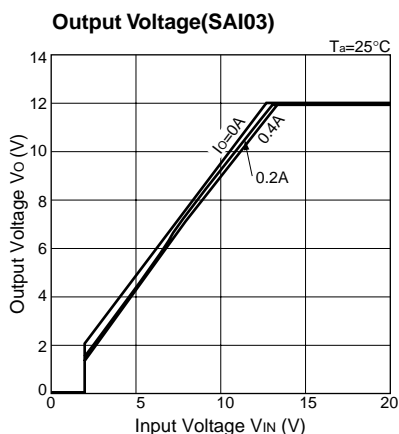

SI-8000E Series

Full-Mold, Separate Excitation Switching Type

■Features

- Compact full-mold package (equivalent to TO220)
- High efficiency: 80 to 88%
- Requires only 4 external components
- Phase correction and output voltage adjustment performed internally
- Built-in reference oscillator (60kHz)
- Built-in overcurrent and thermal protection circuits

■Applications

- Power supplies for telecommunication equipment
- Onboard local power supplies

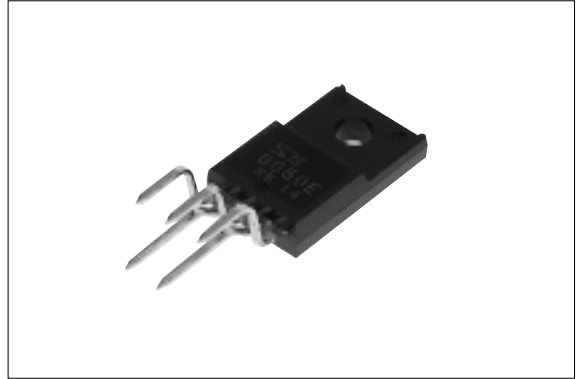

■Lineup

Part Number	SI-8050E	SI-8090E	SI-8120E
$V_o(V)$	5.0	9.0	12.0
$I_o(A)$	0.6		

■Absolute Maximum Ratings

Parameter	Symbol	Ratings	Unit
DC Input Voltage	V_{IN}	43	V
Power Dissipation	P_{D1}	14(With infinite heatsink)	W
	P_{D2}	1.5(Without heatsink, stand-alone operation)	W
Junction Temperature	T_j	+125	°C
Storage Temperature	T_{stg}	-40 to +125	°C
Thermal Resistance(junction to case)	$R_{th(j-c)}$	7.0	°C/W
Thermal Resistance(junction to ambient air)	$R_{th(j-a)}$	66.7	°C/W

■Recommended Operating Conditions

Parameter	Symbol	Ratings			Unit
		SI-8050E	SI-8090E	SI-8120E	
DC Input Voltage Range	V_{IN}	7 to 40	11 to 40	14 to 40	V
Output Current Range	I_o	0 to 0.6			A
Operating Junction Temperature Range	T_{jop}	-30 to +125			°C
Operating Temperature Range	T_{op}	-30 to +125			°C

■Electrical Characteristics

(Ta=25°C)

Parameter	Symbol	Ratings									Unit
		SI-8050E			SI-8090E			SI-8120E			
		min.	typ.	max.	min.	typ.	max.	min.	typ.	max.	
Output Voltage	Vo	4.80	5.00	5.20	8.64	9.00	9.36	11.52	12.00	12.48	V
	Conditions	VIN=20V, Io=0.3A			VIN=21V, Io=0.3A			VIN=24V, Io=0.3A			
Efficiency	η		80			86			88		%
	Conditions	VIN=20V, Io=0.3A			VIN=21V, Io=0.3A			VIN=24V, Io=0.3A			
Switching Frequency	f		60			60			60		kHz
	Conditions	VIN=20V, Io=0.3A			VIN=21V, Io=0.3A			VIN=24V, Io=0.3A			
Line Regulation	ΔV _{OLINE}		80	100		90	120		100	130	mV
	Conditions	VIN=10 to 30V, Io=0.3A			VIN=14 to 30V, Io=0.3A			VIN=17 to 30V, Io=0.3A			
Load Regulation	ΔV _{OLOAD}		30	40		50	80		70	95	mV
	Conditions	VIN=20V, Io=0.1 to 0.4A			VIN=21V, Io=0.1 to 0.4A			VIN=24V, Io=0.1 to 0.4A			
Temperature Coefficient of Output Voltage	ΔVo/ΔTa		±0.5			±1.0			±1.5		mV/°C
Ripple Rejection	RREJ		45			45			45		dB
	Conditions	f=100 to 120Hz			f=100 to 120Hz			f=100 to 120Hz			
Overcurrent Protection Starting Current	Is1	0.61			0.61			0.61			A
	Conditions	VIN=10V			VIN=14V			VIN=17V			

■External Dimensions

(unit: mm)

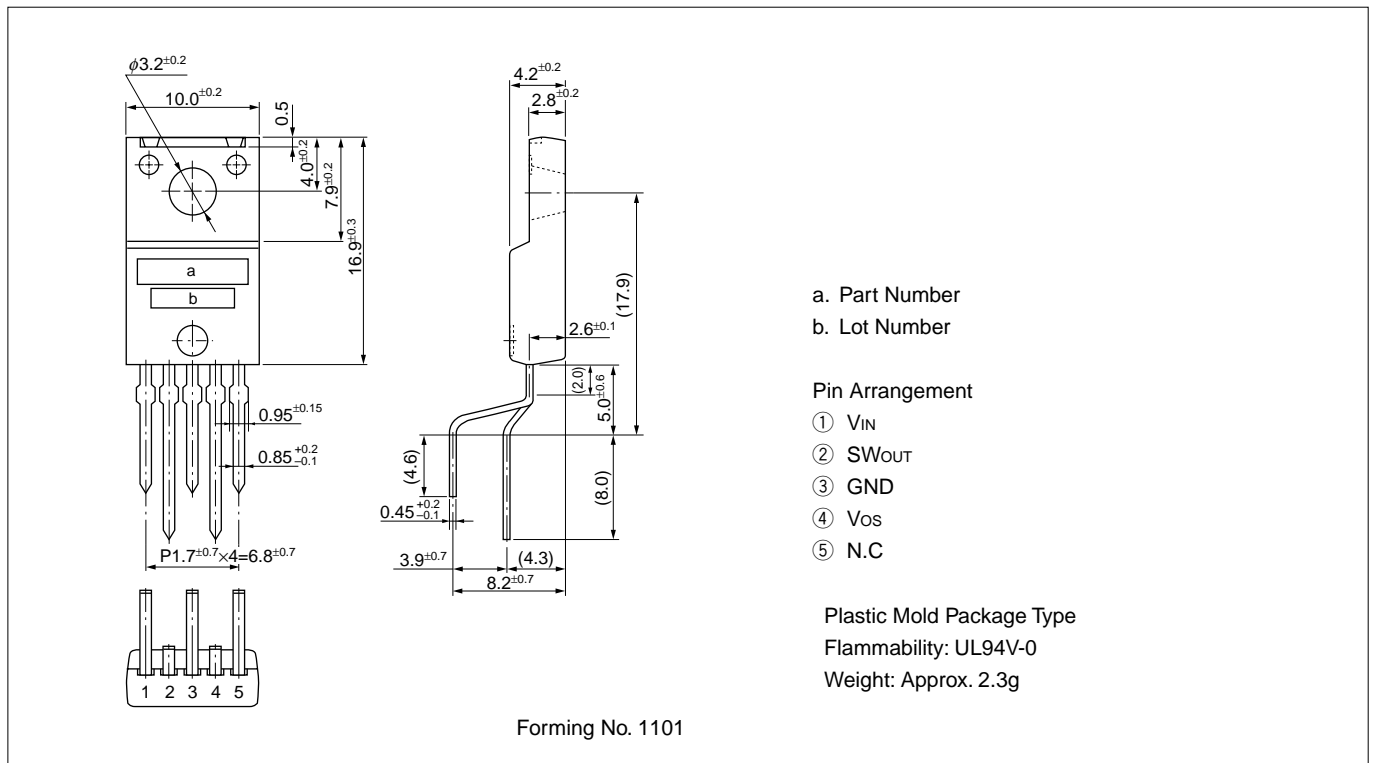

■Block Diagram

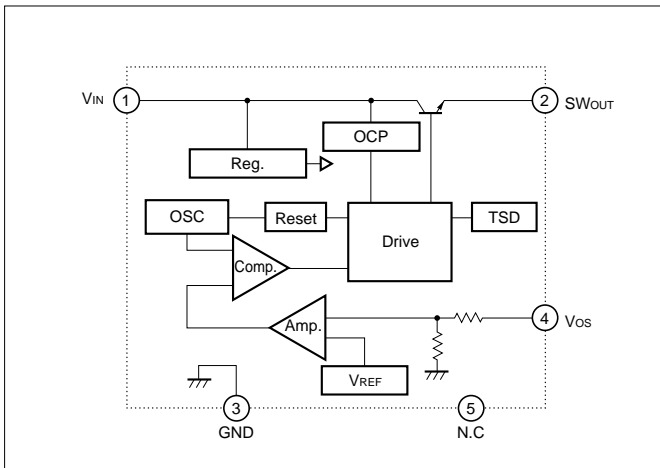

■Standard External Circuit

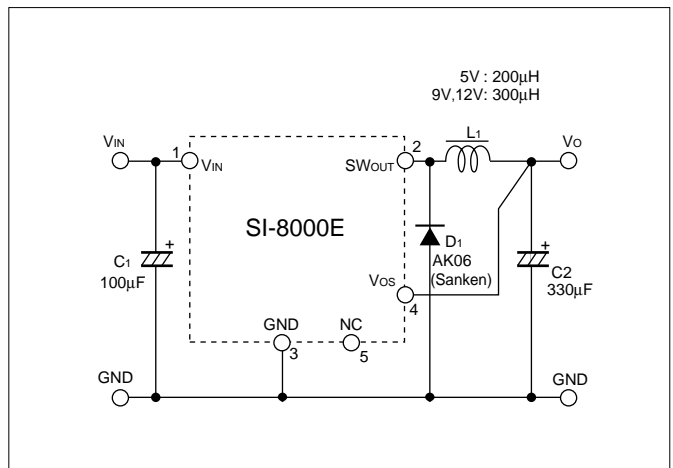

■Ta-Pd Characteristics

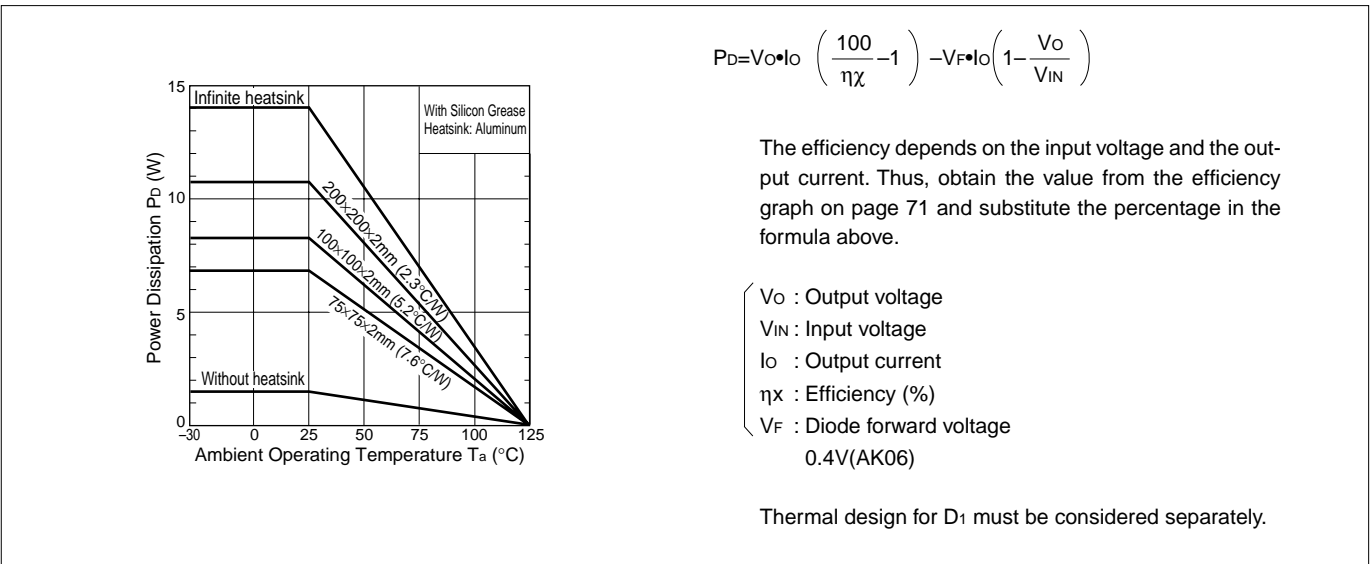

■Selecting External Components

1. Inductor L1

1) It must be suited for switching regulators.

Do not use inductors such as noise filters, because they generate excessive heat.

2) It must have the appropriate inductance value.

If the inductance is too small (150µH or lower), abnormal oscillation may occur causing operation problems in the overcurrent protection circuit within the rated current range.

3) The rated current must be satisfied.

If the rated current is exceeded, magnetic saturation leads to overcurrent.

2. Capacitors C1 and C2

1) They must satisfy the breakdown voltage and allowable ripple current.

Exceeding the ratings of these capacitors or using them without derating shortens their service lives and may also cause abnormal oscillation of the IC.

2) C2 should a low-impedance type capacitor.

A low-impedance type capacitor is recommended for C2 to ensure reduced ripple voltage and stable switching operation.

3. Diode D1

The Sanken AK06 diode is recommended for D1. If you intended to use an equivalent diode, be sure to use a Schottky Barrier diode and make sure that the reverse voltage applied to terminal 2 of the IC does not exceed the value (-1V) given in the absolute maximum ratings. If you use a fast recovery diode or any other diode, supplying a reverse voltage generated from the recovery or ON voltage of the diode may damage the IC.

Application

Variable output voltage

Output voltage can be adjusted in the same way as SI-8000S in page 77.

■Typical Characteristics

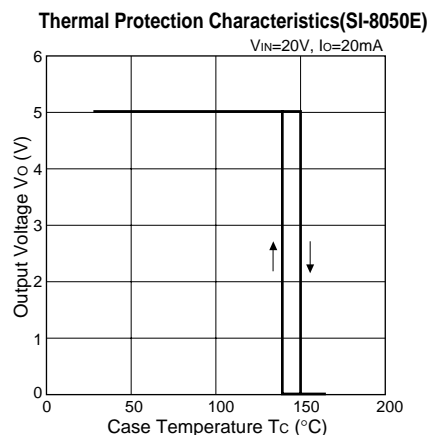
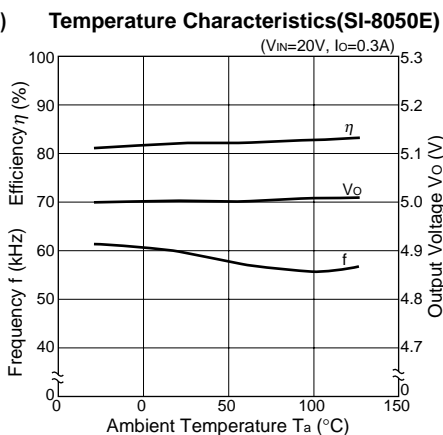
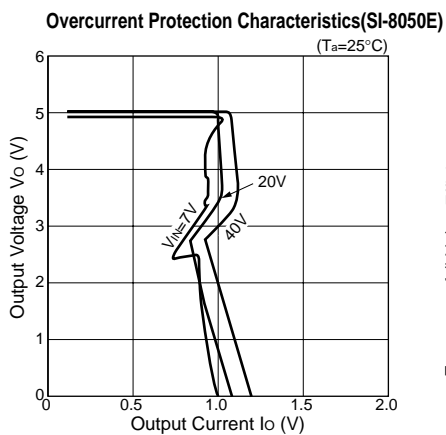
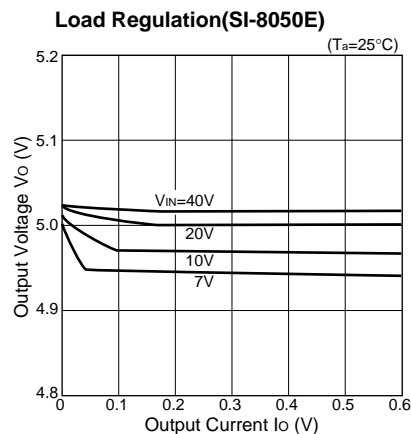
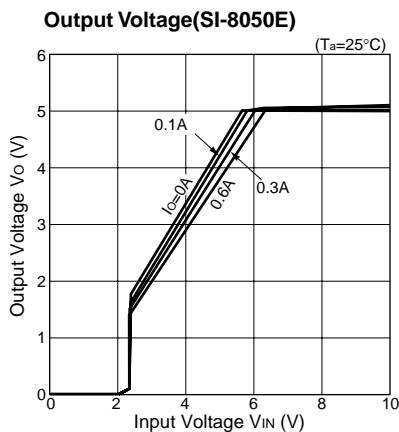
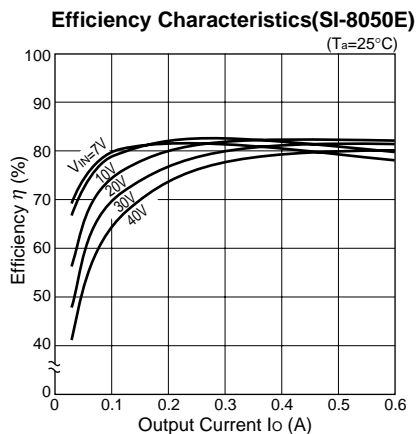

Note on Thermal Protection:

The thermal protection circuit is intended for protection against heat during instantaneous short-circuiting. Its operation is not guaranteed for continuous heating condition such as short-circuiting over extended periods of time.

SI-8000S Series

Full-Mold, Separate Excitation Switching Type

■Features

- Compact full-mold package (equivalent to TO220)
- Output current: 3.0A
- High efficiency: 79 to 91%
- Requires only 4 external components
- Phase correction and output voltage adjustment performed internally
- Built-in reference oscillator (60kHz)
- Built-in overcurrent and thermal protection circuits
- Built-in soft start circuit (output ON/OFF control)

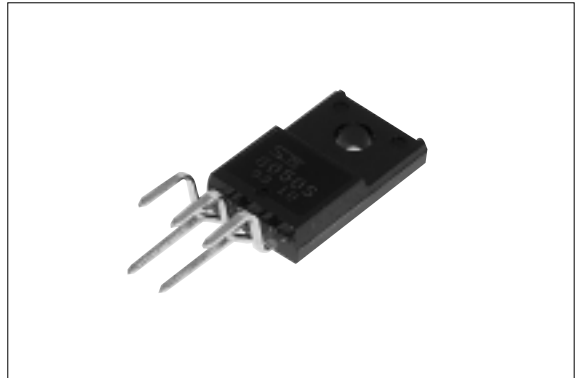

■Applications

- Power supplies for telecommunication equipment
- Onboard local power supplies

■Lineup

Part Number	SI-8033S	SI-8050S	SI-8090S	SI-8120S	SI-8150S
Vo(V)	3.3	5.0	9.0	12.0	15.0
Io(A)	3.0				

■Absolute Maximum Ratings

Parameter	Symbol	Ratings	Unit
DC Input Voltage	V _{IN}	43*	V
Power Dissipation	P _{D1}	18(With infinite heatsink)	W
	P _{D2}	1.5(Without heatsink, stand-alone operation)	W
Junction Temperature	T _j	+125	°C
Storage Temperature	T _{stg}	-40 to +125	°C
SW Terminal Applied Reverse Voltage	V _{sw}	-1	V
Thermal Resistance(junction to case)	R _{th(j-c)}	5.5	°C/W

*SI-8033S: 35V

■Recommended Operating Conditions

Parameter	Symbol	Ratings					Unit
		SI-8033S	SI-8050S	SI-8090S	SI-8120S	SI-8150S	
DC Input Voltage Range	V _{IN}	5.5 to 28	7 to 40	12 to 40	15 to 40	18 to 40	V
Output Current Range	I _o	0 to 3.0					A
Operating Junction Temperature Range	T _{jop}	-30 to +125					°C

■Electrical Characteristics

(Ta=25°C)

Parameter	Symbol	Ratings															Unit
		SI-8033S			SI-8050S			SI-8090S			SI-8120S			SI-8150S			
		min.	typ.	max.	min.	typ.	max.	min.	typ.	max.	min.	typ.	max.	min.	typ.	max.	
Output Voltage	SI-8000S*1	3.17	3.30	3.43	4.80	5.00	5.20	8.55	9.00	9.45	11.50	12.00	12.50	14.25	15.00	15.75	V
	SI-8000SS	3.234	3.30	3.366	4.90	5.00	5.10	8.73	9.00	9.27	—			—			
	Conditions	VIN=15V, IO=1.0A			VIN=20V, IO=1.0A			VIN=21V, IO=1.0A			VIN=24V, IO=1.0A			VIN=25V, IO=1.0A			
Efficiency	η		79			84			88			90			91		%
	Conditions	VIN=15V, IO=1.0A			VIN=20V, IO=1.0A			VIN=21V, IO=1.0A			VIN=24V, IO=1.0A			VIN=25V, IO=1.0A			
Switching Frequency	f		60			60			60			60			60		kHz
	Conditions	VIN=15V, IO=1.0A			VIN=20V, IO=1.0A			VIN=21V, IO=1.0A			VIN=24V, IO=1.0A			VIN=25V, IO=1.0A			
Line Regulation	ΔV _{OLINE}		25	80		40	100		50	120		60	130		60	130	mV
	Conditions	VIN=8 to 28V, IO=1.0A			VIN=10 to 30V, IO=1.0A			VIN=15 to 30V, IO=1.0A			VIN=18 to 30V, IO=1.0A			VIN=21 to 30V, IO=1.0A			
Load Regulation	ΔV _{OLOAD}		10	30		10	40		10	40		10	40		10	40	mV
	Conditions	VIN=15V, IO=0.5 to 1.5A			VIN=20V, IO=0.5 to 1.5A			VIN=21V, IO=0.5 to 1.5A			VIN=24V, IO=0.5 to 1.5A			VIN=25V, IO=0.5 to 1.5A			
Temperature Coefficient of Output Voltage	ΔV _O /ΔT _a		±0.5			±0.5			±1.0			±1.0			±1.0		mV/°C
Ripple Rejection	R _{REJ}		45			45			45			45			45		dB
	Conditions	f=100 to 120Hz			f=100 to 120Hz			f=100 to 120Hz			f=100 to 120Hz			f=100 to 120Hz			
Overcurrent Protection Starting Current	I _{S1}	3.1			3.1			3.1			3.1			3.1			A
	Conditions	VIN=15V			VIN=20V			VIN=21V			VIN=24V			VIN=25V			

*1: "S" may be indicated to the right of the Sanken logo (except SI-8120S, SI-8150S)

■External Dimensions

(unit: mm)

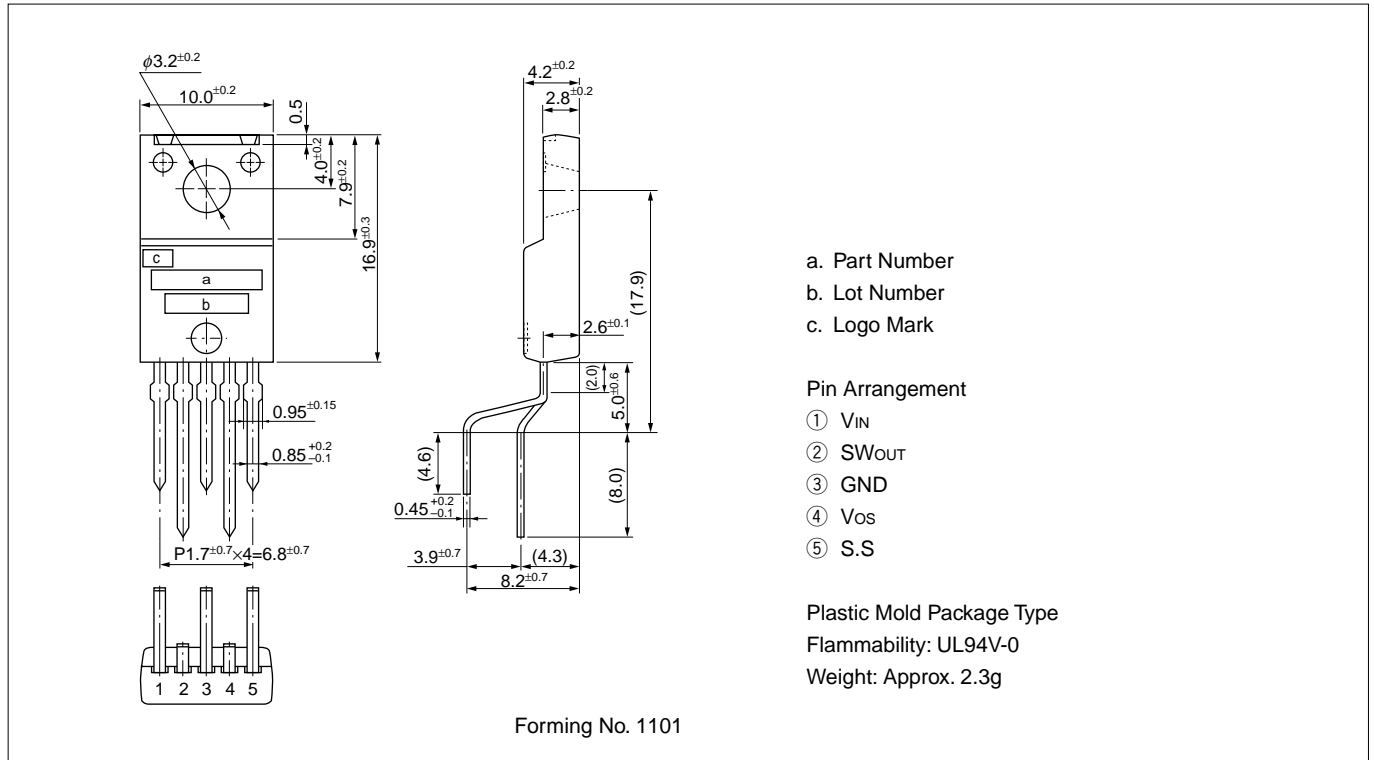

■Block Diagram

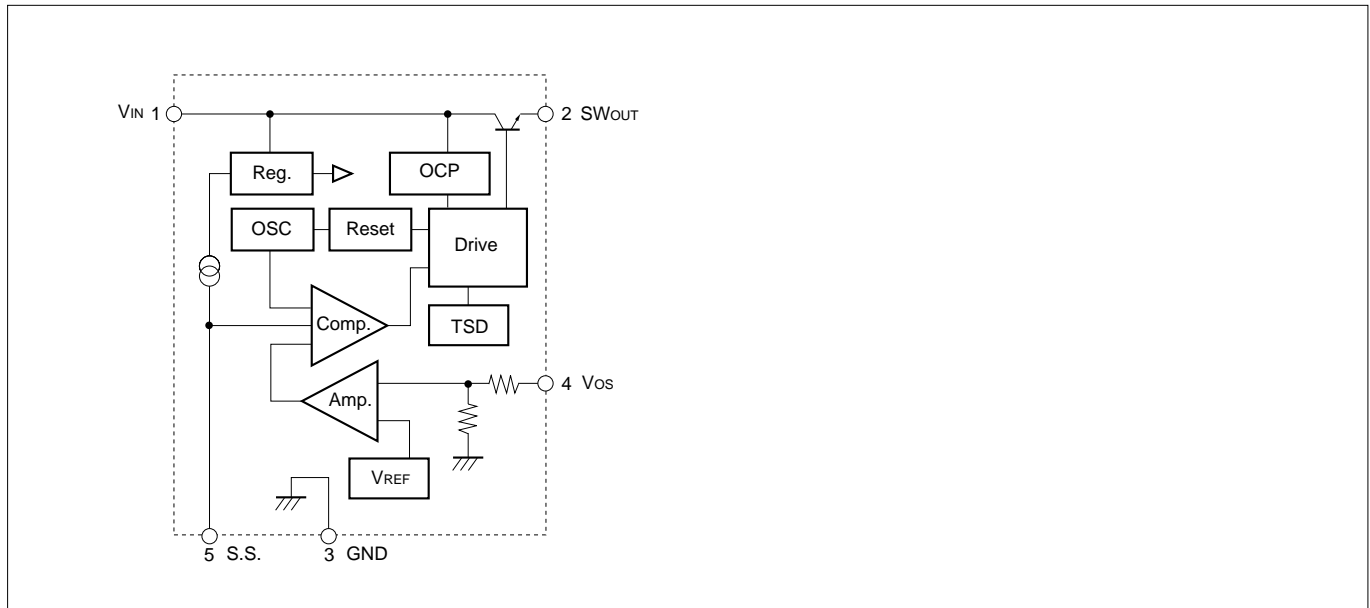

■Standard External Circuit

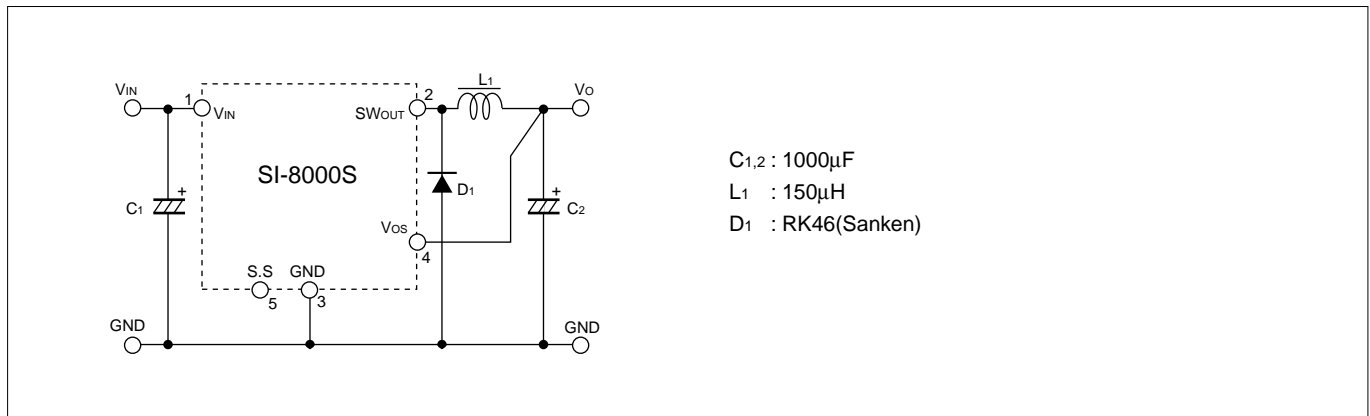

■ T_a - P_D Characteristics

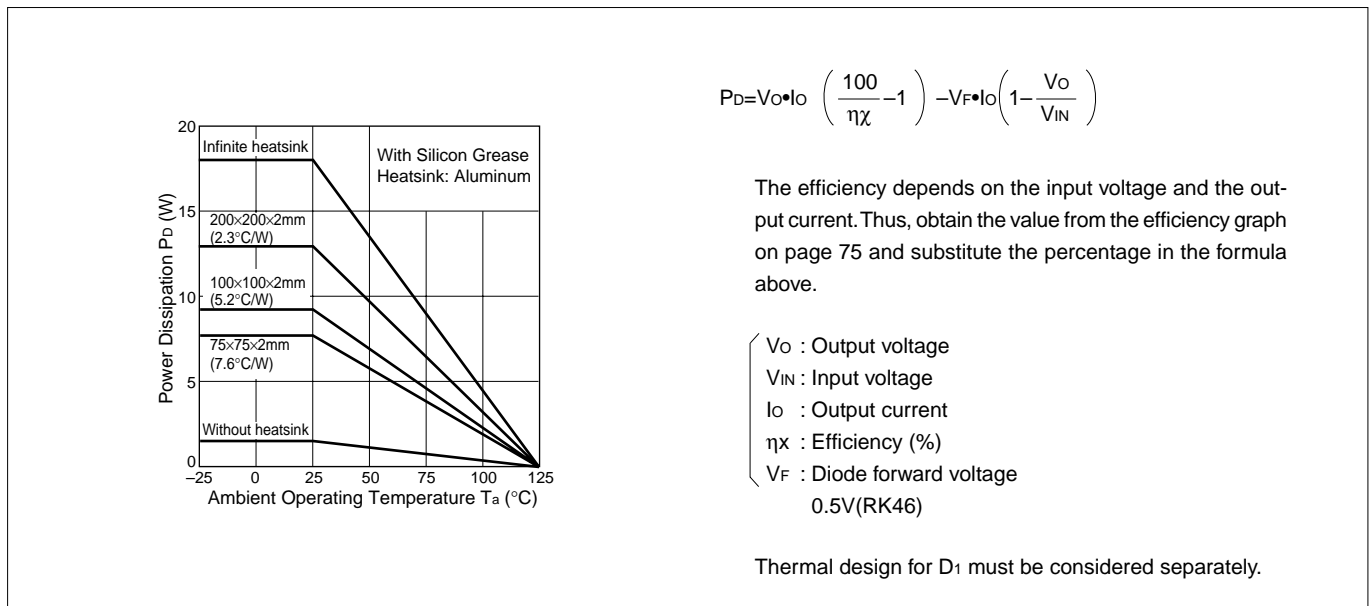

■Typical Characteristics

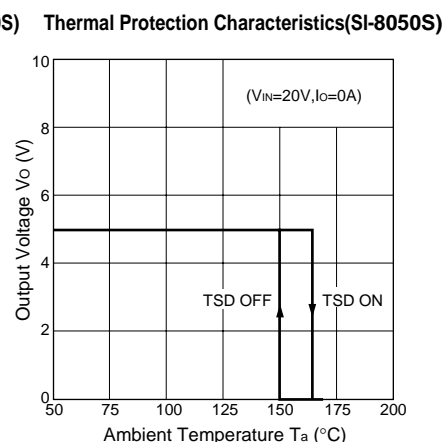
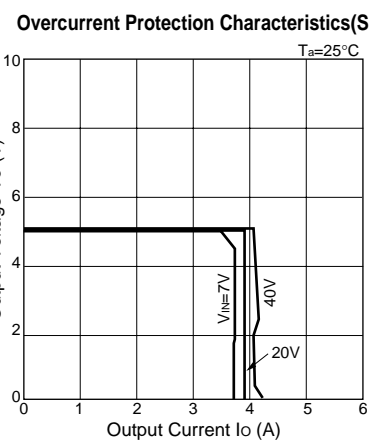
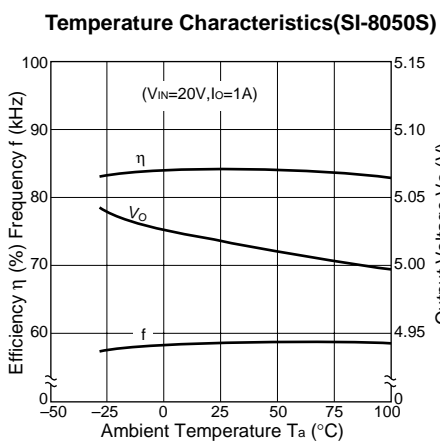
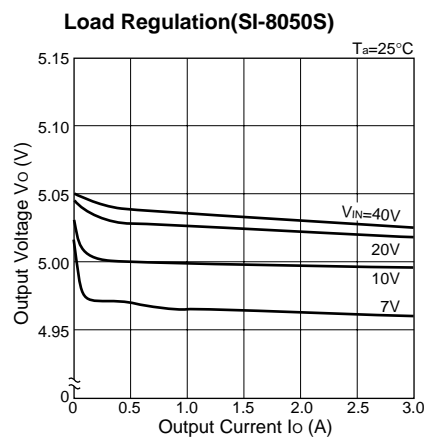
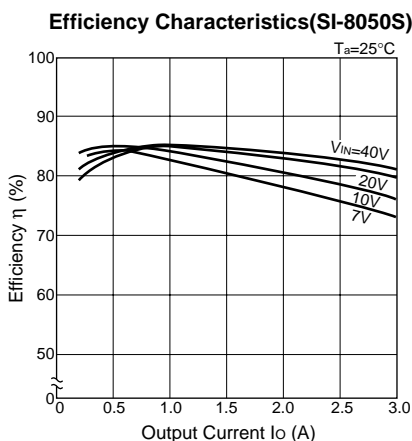
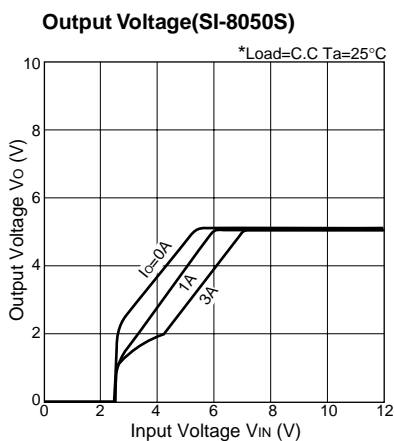

Note on Thermal Protection:

The thermal protection circuit is intended for protection against heat during instantaneous short-circuiting. Its operation is not guaranteed for continuous heating condition such as short-circuiting over extended periods of time.

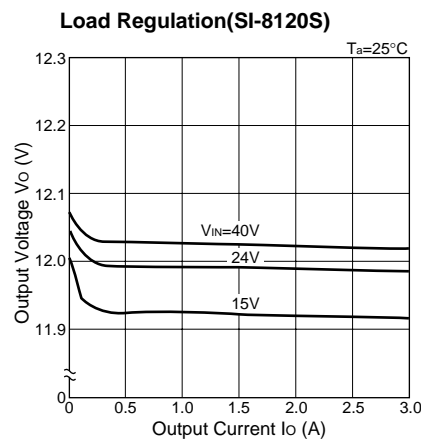
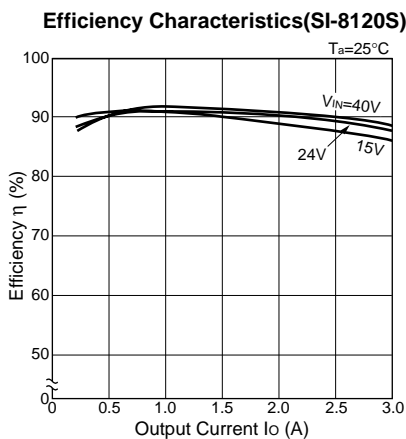
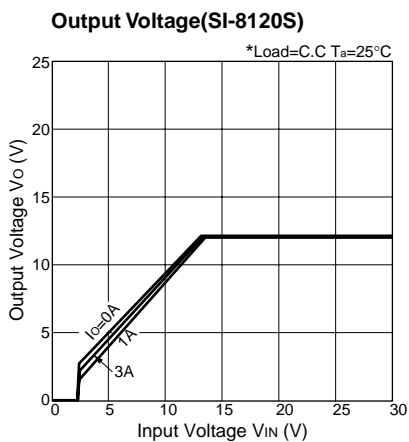

Application Notes

1. Selecting External Components

(1) Choke coil L₁

To maintain the stable operation of the regulator, choke coil L₁ should be selected appropriately.

When selecting choke coil L₁, consider the following:

- a) Suitable for a switching regulator
Do not use a coil as a noise filter because it generates excess heat.
- b) Appropriate inductance
The greater the inductance of the choke coil, the smaller the output ripple voltage. However, the size of the coil increases large as the inductance increases. If the inductance is low, a greater peak current flows to the IC and loss increases. This is not favorable for stable operation.

The standard external circuit shows reference inductance values suitable for stable operation. However, the appropriate inductance may also be calculated as follows:

$$L = \frac{(V_{IN} - V_O) \cdot V_O}{\Delta I_L \cdot V_{IN} \cdot f}$$

Where, ΔI_L indicates the ripple current of the choke coil that is roughly set as follows:

- If the output current is close to the maximum rating (3 A) of SI-8000S
Ripple current = output current × 0.2 to 0.3
- If the output current is about 1.0A or less
Ripple current = output current × 0.3 to 0.4

- c) Satisfying the rated current
The rated current of a choke coil must be greater than the maximum load current. Note that the inductance decreases drastically and an excess current flows if the load current exceeds the rated current of the coil.
- d) Good DC current superposition characteristics
The current flowing through a choke coil is a triangular waveform current superimposed on a DC current equal to the load current. The coil inductance decreases as the load current increases. In general, the coil can be used until the inductance drops to 50% of the rated value. Use this as the reference value for selection.

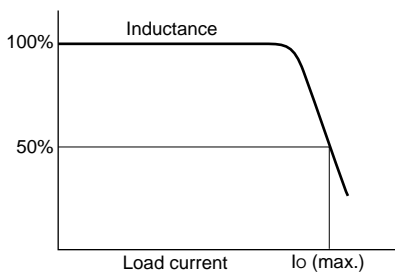

- e) Less noise
A drum-type open magnetic core coil can affect peripheral circuits with noise because the flux passes outside the coil. To avoid this problem, use a toroidal, EI, or EE type closed magnetic core coil.

- (2) Input capacitor C₁
Input capacitor C₁ operates as a bypass capacitor in the input circuit.

When selecting input capacitor C₁, consider the following:

- a) The breakdown voltage is higher than the maximum input voltage.
- b) Satisfies the allowable ripple current
Exceeding the ratings of this capacitor or using it without derating may reduce its service life and also cause the regulator to malfunction. Therefore, an input capacitor with a sufficient margin should be selected. With the SI-8000S Series, the effective ripple current I_{rms} flowing to the input capacitor can be calculated approximately as follows:

$$I_{rms} \approx 1.2 \times \frac{V_O}{V_{IN}} \times I_O$$

- (3) Output capacitor C₂
Output capacitor C₂ operates as a smoothing capacitor for switching output. The output ripple voltage from the regulator is determined by the product of the pulsating current part ΔI_L (=C₂ charge-discharge current) of the choke coil current and the equivalent series resistance ESR of the output capacitor C₂.

$$V_{rip} = \Delta I_L \cdot C_2 \cdot ESR$$

Therefore, a capacitor of low equivalent series resistance ESR should be selected to reduce the output ripple voltage. It is recommended to select a low-impedance capacitor intended for use with switching regulators as C₂.

- (4) Diode D₁
Use a Schottky barrier diode for D₁. If you use a general rectifier diode or fast recovery diode, the IC may be damaged. (Sanken RK46 recommended)

2. Cautions on Pattern Design

- (1) Large current line
Since a large current flows through the bold lines in the standard external circuit make the pattern as wide and as short as possible.

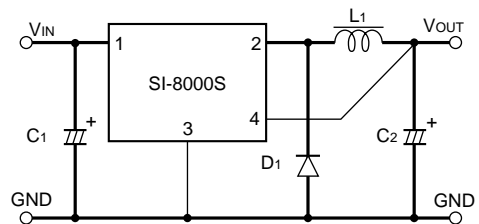

- (2) Input capacitor
Place the input capacitor C₁ and output capacitor C₂ as close to the IC as possible. Since a large current flows through the lead wires of the input and output capacitors to charge and discharge them quickly, minimize the lead wire length. The pattern around the capacitors should also be minimized.

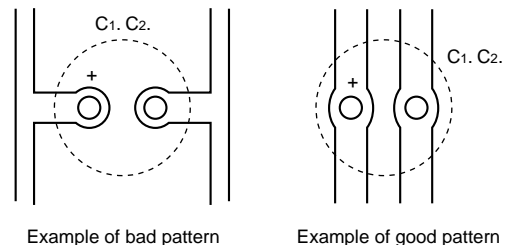

(3) Sensing terminal

Output voltage sensing terminal V_{OS} should be connected as close to output capacitor C_2 as possible. If the terminal is far from the capacitor, the decreasing regulation and increasing switching ripple may result in abnormal oscillation.

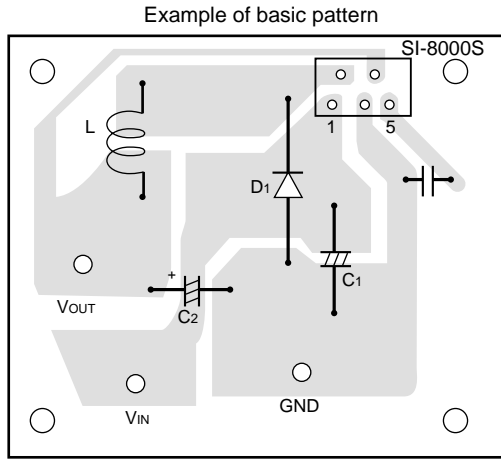

Top view (with part names)

Applications

1. Soft Start

Connecting a capacitor to terminal no. 5 permits a soft start at power-on. Delay time T_d and rise time T_s can roughly be calculated as shown below. (However, the values may slightly vary in an actual application.) If the capacitance of C_3 is increased, it takes longer to discharge C_3 after V_{IN} is turned off. Therefore, it is recommended to set the value to $10\mu F$ or less. When not using the soft start function, keep terminal no. 5 open.

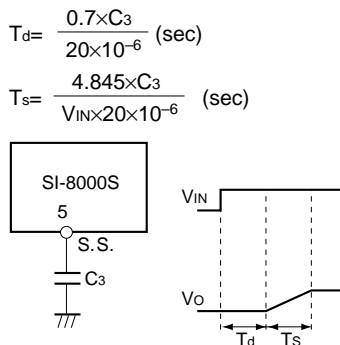

2. Output ON/OFF control

Output can be turned on and off by using the soft start terminals. Set the soft start terminal voltage to V_{SSL} (0.2V typ.) or less to stop output. To switch the potential at the soft start terminals, drive the open collector of the transistor. Since the discharge current from C_3 flows to the ON/OFF control transistor, limit the current for protection. The SS terminal is pulled up to the power supply in the IC and no external voltage can be applied.

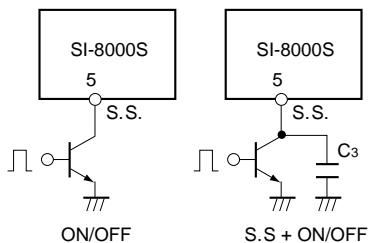

3. Variable Output Voltage

The output voltage can be increased by connecting a resistor to V_{OS} terminal No. 4. (There is no way of decreasing the voltage)

(1) Variable output voltage with single external resistor

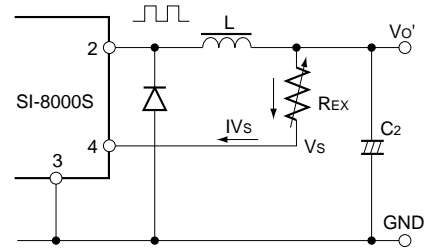

The output voltage adjustment resistance R_{EX} is calculated as follows:

$$R_{EX} = \frac{V_{O'} - V_s}{I_{V_s}}$$

V_s : Output voltage of product

$V_{O'}$: Adjusted output voltage

I_{V_s} : Inflow current to V_s terminal

* The temperature characteristics of output voltage worsen because the value R_{EX} is not compensated for temperature. The V_s value fluctuates by up to $\pm 20\%$ depending on the IC product. Since the output voltage fluctuates more, a semi-fixed resistor is necessary for accurate output voltage adjustment. If V_s and R_{EX} are constant, the range of output voltage fluctuation can be expressed as follows:

$$\Delta V_{O'}(\%) = \pm 20 \cdot \frac{V_{O'} - V_s}{V_{O'}}$$

$\Delta V_{O'}$: Adjusted output voltage

(2) Variable output voltage with two external resistors

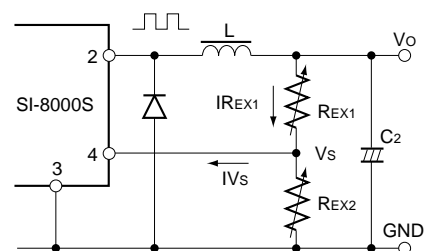

The output voltage adjustment resistances R_{EX1} and R_{EX2} are calculated as follows:

$$R_{EX1} = \frac{V_{O'} - V_s}{S \cdot I_{V_s}}$$

$$R_{EX2} = \frac{V_s}{(S-1) \cdot I_{V_s}}$$

S: Stability factor

Bypassing the current to R_{EX2} improves the temperature characteristics and voltage fluctuation ranges more than the method of (1). Stability factor S indicates the ratio of R_{EX1} to V_s terminal inflow current. Increasing the S value improves the fluctuations of the temperature characteristics and output voltage. (Usually 5 to 10)

If the V_s and R_{EX} values are constant, the output voltage fluctuation range can be calculated as follows:

$$\Delta V_{O'}(\%) = \frac{\pm 20}{S} \cdot \frac{V_{O'} - V_s}{V_{O'}}$$

SI-8200L/8300L Series

Self Oscillating Switching Type with Coil

■Features

- Integrated switching IC and coil construction
- Requires 2 external components only
- Low switching noise
- Heatsink not required

■Applications

- Telephone power supplies
- Onboard local power supplies

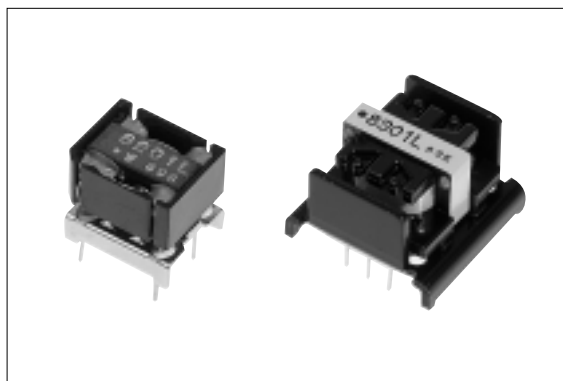

■Lineup

Part Number	SI-8201L	SI-8203L	SI-8211L	SI-8213L	SI-8301L
Vo(V)	5	12	5	12	5
Io(A)	0.4	0.35	0.3	0.28	1.0

■Absolute Maximum Ratings

Parameter	Symbol	Ratings			Unit
		SI-8201L/8203L	SI-8211L/8213L	SI-8301L	
DC Input Voltage	V _{IN}	45	60	45	V
Power Dissipation	P _D	1.5	1.17	3.0	W
Junction Temperature	T _j	+100			°C
Storage Temperature	T _{stg}	-25 to +85			°C

■Recommended Operating Conditions

Parameter	Symbol	Ratings					Unit
		SI-8201L	SI-8203L	SI-8211L	SI-8213L	SI-8301L	
DC Input Voltage Range	V _{IN}	10 to 40	16 to 40	15 to 55	22 to 55	8 to 40	V
Output Current Range	I _o	0 to 0.4	0 to 0.35	0 to 0.3	0 to 0.28	0 to 1.0	A
Operating Temperature Range	T _{op}	-10 to +65			-10 to +85		°C

■Electrical Characteristics

(Ta=25°C)

Parameter	Symbol	Ratings															Unit
		SI-8201L			SI-8203L			SI-8211L			SI-8213L			SI-8301L			
		min.	typ.	max.	min.	typ.	max.	min.	typ.	max.	min.	typ.	max.	min.	typ.	max.	
Output Voltage	Vo	4.9	5.0	5.1	11.8	12.0	12.2	4.9	5.0	5.1	11.8	12.0	12.2	5.0	5.1	5.2	V
	Conditions	VIN=15V, Io=0.2A			VIN=25V, Io=0.2A			VIN=35V, Io=0.2A			VIN=38V, Io=0.2A			VIN=15V, Io=0.5A			
Efficiency	η		73			79		63			78			73		%	
	Conditions	VIN=15V, Io=0.2A			VIN=25V, Io=0.2A			VIN=35V, Io=0.2A			VIN=38V, Io=0.2A			VIN=15V, Io=0.5A			
Switching Frequency	f	25			25			25			25			25		kHz	
Line Regulation	ΔV _{OLINE}		15	60		15	60			60			60			mV	
	Conditions	VIN=10 to 20V, Io=0.2A			VIN=16 to 34V, Io=0.2A			VIN=20 to 50V, Io=0.2A			VIN=22 to 50V, Io=0.2A			VIN=10 to 20V, Io=0.5A			
Load Regulation	ΔV _{OLOAD}		15	60		60	100			60			60			mV	
	Conditions	VIN=15V, Io=0.02 to 0.25A			VIN=25V, Io=0.02 to 0.3A			VIN=35V, Io=0.02 to 0.3A			VIN=38V, Io=0.02 to 0.28A			VIN=15V, Io=0.3 to 0.7A			
Temperature Coefficient of Output Voltage	ΔVo/ΔTa			±1.5			±1.5			±1.5			±1.5			mV/°C	
Switching Ripple Voltage (C ₂ =470μF)	ΔV _r		30	60		60	100		30	60		50	100		45	mV _{p-p}	
	Conditions	VIN=25V, Io=0.3A			VIN=40V, Io=0.35A			VIN=48V, Io=0.3A			VIN=48V, Io=0.28A			VIN=15V, Io=0.5A			

■External Dimensions

(unit: mm)

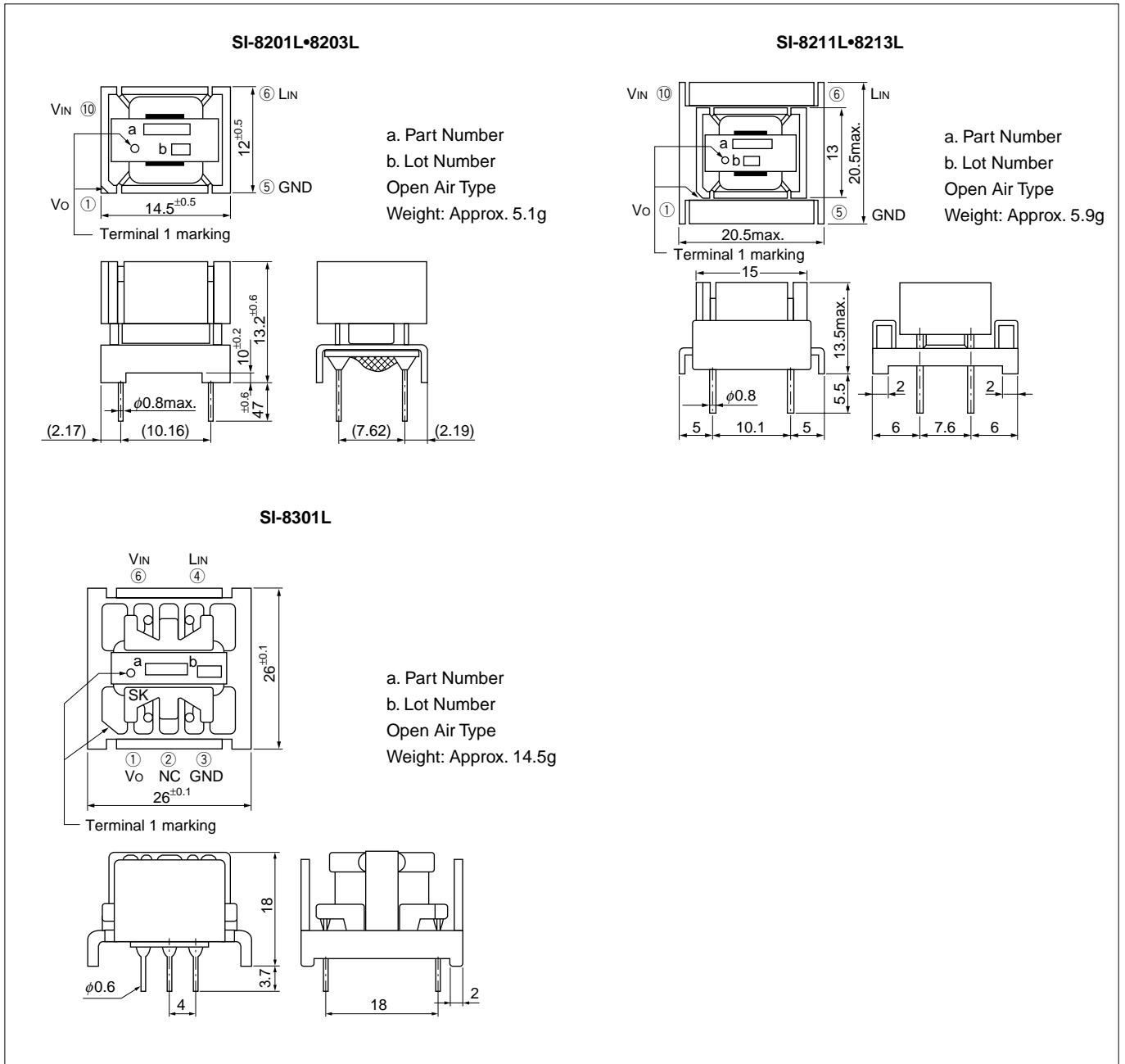

■Block Diagram

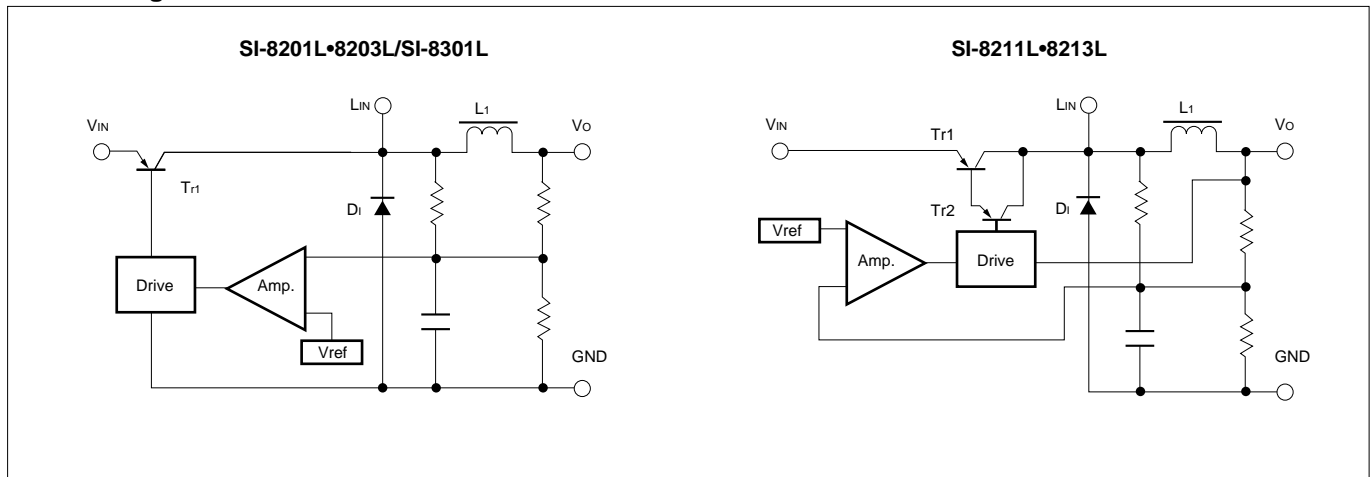

■Standard External Circuit

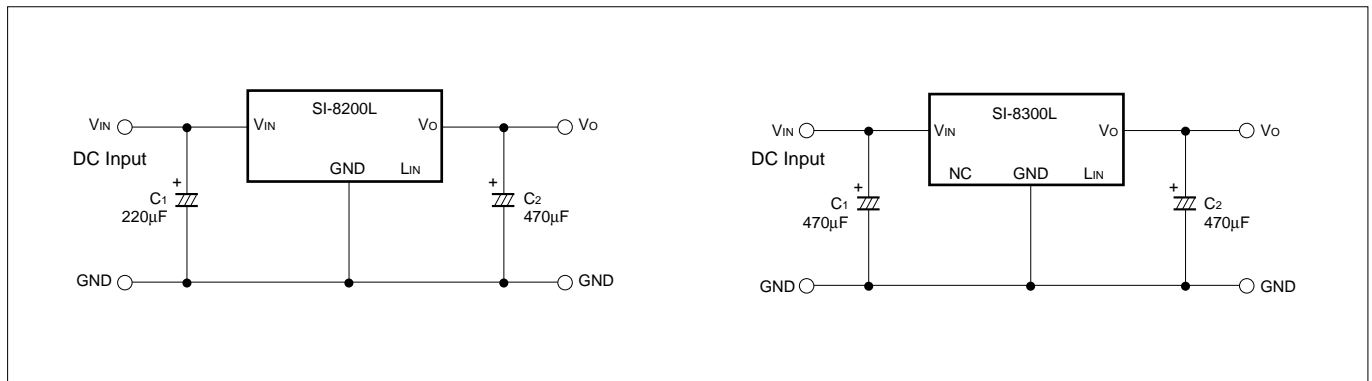

■Ta-Pd Characteristics

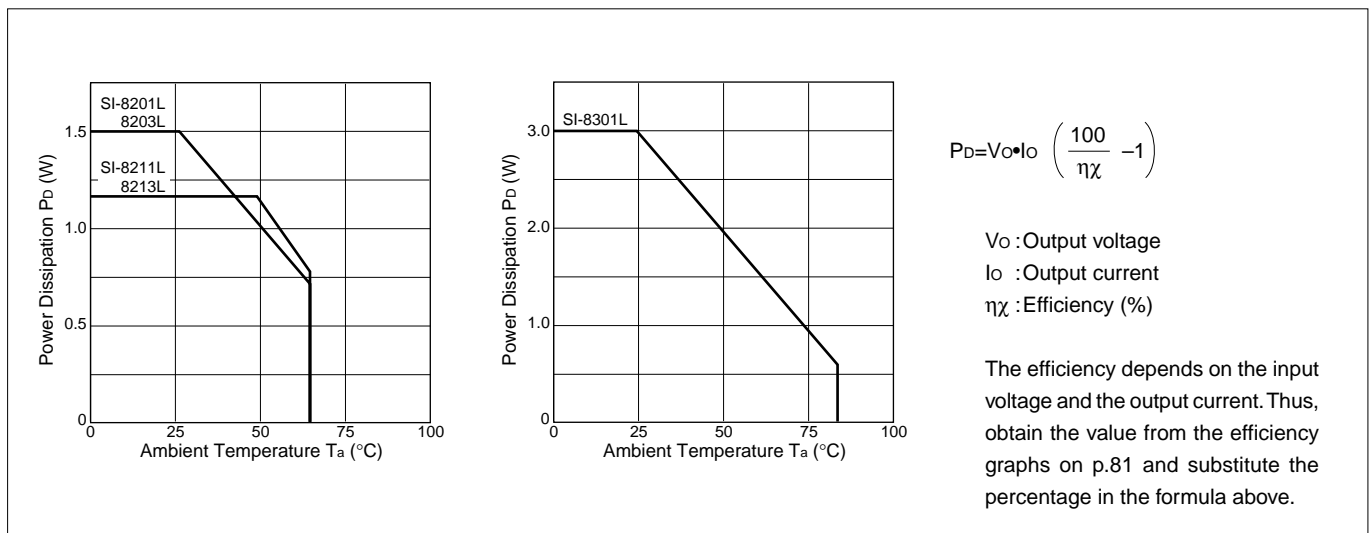

■Caution

1. A low-impedance capacitor suitable for switching applications must be used for the external capacitor and must be connected as close to the IC as possible in order to assure low ripple voltage and stable switching operation.
2. The SI-8200L and 8300L series do not have a built-in overcurrent protection circuit. Thus, avoid short-circuit conditions that may cause an overcurrent.
3. The SI-8300L series may not start up if the input voltage rises too rapidly.
Do not use the SI-8300L series in applications where the input terminal, pin6, is opened and closed directly in a state where the input voltage is already applied.
4. Terminals LIN and NC in the connection diagram must be left unconnected to other circuits.
5. The IC's metallic heatsink is electrically floating. Do not connect it to GND or any other circuit.
6. Since the SI-8200L and 8300L series have an open-package construction, they can only be used in specific environments. Verify the operating environment and use the IC within the conditions indicated in the reliability data.

■Typical Characteristics

($T_a=25^\circ\text{C}$)

SI-8201L

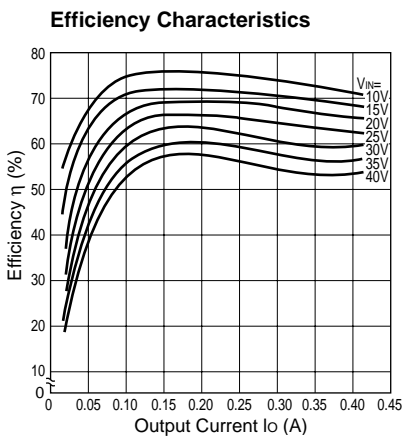
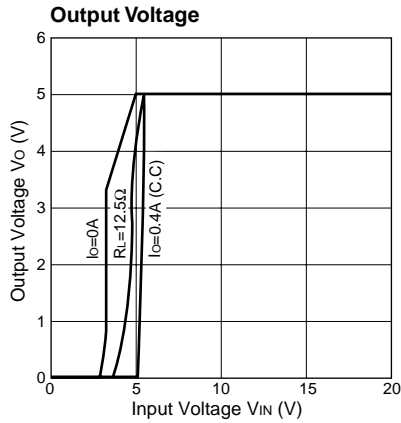

SI-8203L

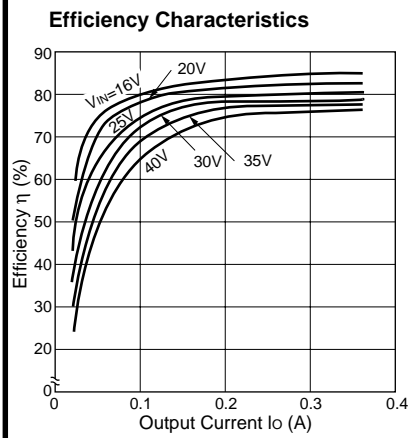
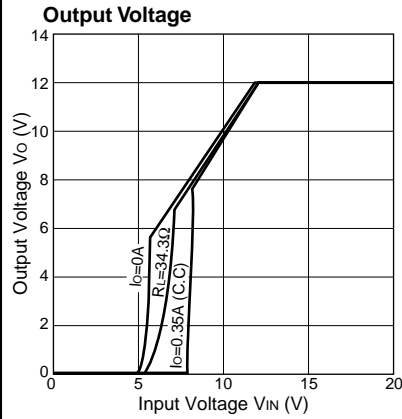

SI-8211L

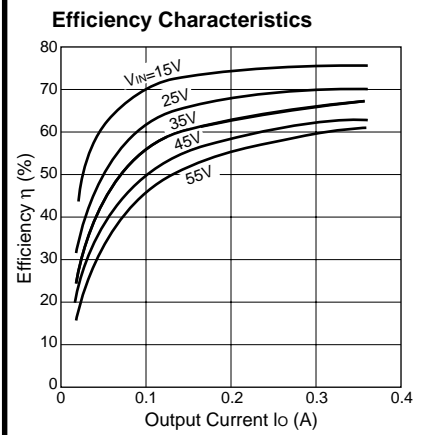
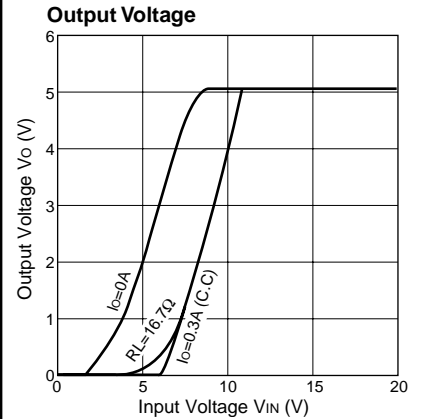

SI-8213L

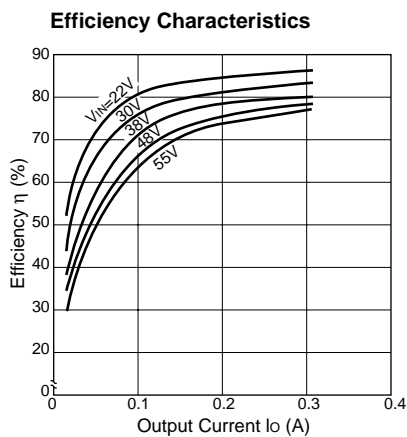
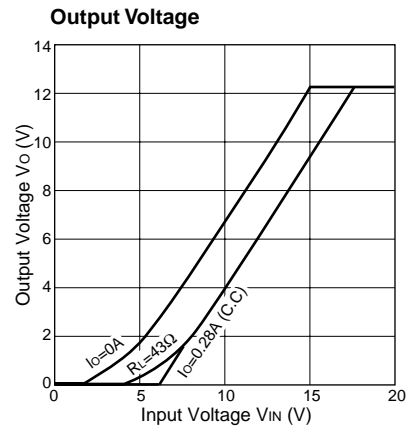

SI-8301L

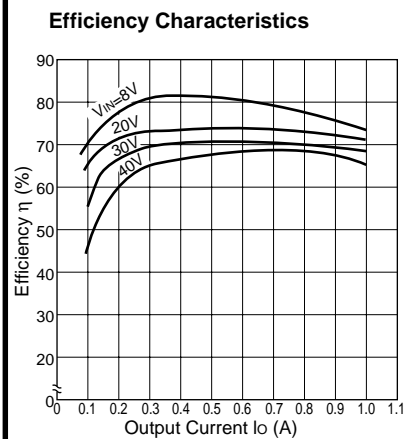
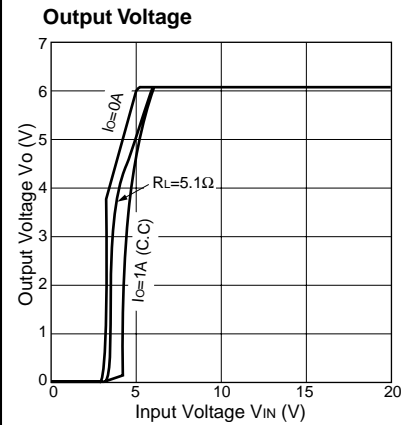

SI-8400L/8500L Series

Separate Excitation Switching Type with Coil

■Features

- Integrated switching IC and coil construction
- Requires 2 external components only
- Low switching noise
- Heatsink not required
- Built-in overcurrent and thermal protection circuits
- Built-in soft start circuit (Output ON/OFF control)...SI-8500L Series

■Applications

- Telephone power supplies
- Onboard local power supplies

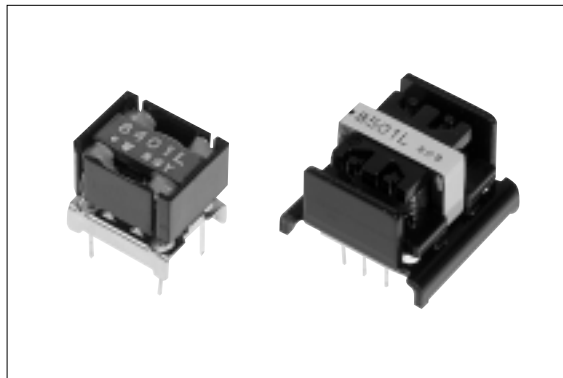

■Lineup

Part Number	SI-8401L	SI-8402L	SI-8403L	SI-8405L	SI-8501L	SI-8502L	SI-8503L	SI-8504L	SI-8505L
$V_o(V)$	5.0	12.0	3.3	15.0	5.0	12.0	3.3	9.0	15.0
$I_o(A)$	0.5	0.4	0.5	0.4	1.0				

■Absolute Maximum Ratings

Parameter	Symbol	Ratings		Unit
		SI-8400L	SI-8500L	
DC Input Voltage	V_{IN}	35		V
Power Dissipation	P_D	1.25	3	W
Junction Temperature	T_j	+100		°C
Storage Temperature	T_{stg}	-25 to +85		°C

■Recommended Operating Conditions

Parameter	Symbol	Ratings				Unit
		SI-8401L	SI-8402L	SI-8403L	SI-8405L	
DC Input Voltage Range	V_{IN}	7 to 33	15 to 33	5.3 to 33	18 to 33	V
Output Current Range	I_o	0 to 0.5	0 to 0.4	0 to 0.5	0 to 0.4	A
Operating Temperature Range	T_{op}	-20 to +85				°C

Parameter	Symbol	Ratings					Unit
		SI-8501L	SI-8502L	SI-8503L	SI-8504L	SI-8505L	
DC Input Voltage Range	V_{IN}	7 to 33	15 to 33	5.3 to 33	12 to 33	18 to 33	V
Output Current Range	I_o	0 to 1.0					A
Operating Temperature Range	T_{op}	-20 to +85					°C

■Electrical Characteristics

(Ta=25°C)

Parameter	Symbol	Ratings												Unit
		SI-8401L			SI-8402L			SI-8403L			SI-8405L			
		min.	typ.	max.	min.	typ.	max.	min.	typ.	max.	min.	typ.	max.	
Output Voltage	Vo	4.80	5.00	5.20	11.40	12.00	12.60	3.17	3.30	3.43	14.25	15.00	15.75	V
	Conditions	VIN=20V, Io=0.3A			VIN=24V, Io=0.3A			VIN=15V, Io=0.3A			VIN=27V, Io=0.3A			
Efficiency	η		80			88			75			89		%
	Conditions	VIN=20V, Io=0.3A			VIN=24V, Io=0.3A			VIN=15V, Io=0.3A			VIN=27V, Io=0.3A			
Switching Frequency	f		60			60			60			60		kHz
	Conditions	VIN=20V, Io=0.3A			VIN=24V, Io=0.3A			VIN=15V, Io=0.3A			VIN=27V, Io=0.3A			
Line Regulation	ΔV _{OLINE}		80	100		100	130		60	80		100	130	mV
	Conditions	VIN=10 to 30V, Io=0.3A			VIN=18 to 30V, Io=0.3A			VIN=8 to 30V, Io=0.3A			VIN=21 to 30V, Io=0.3A			
Load Regulation	ΔV _{OLOAD}		30	40		70	95		20	30		90	120	mV
	Conditions	VIN=20V, Io=0.1 to 0.4A			VIN=24V, Io=0.1 to 0.4A			VIN=15V, Io=0.1 to 0.4A			VIN=27V, Io=0.1 to 0.4A			
Temperature Coefficient of Output Voltage	ΔVo/ΔTa		±0.5			±1.5			±0.5			±1.5		mV/°C
Switching Ripple Voltage (C ₂ =470μF)	ΔV _r		20	40		35	70		15	30		40	80	mV _{p-p}
	Conditions	VIN=20V, Io=0.3A			VIN=24V, Io=0.3A			VIN=15V, Io=0.3A			VIN=27V, Io=0.3A			
Overcurrent Protection Starting Current	Is1	0.55			0.45			0.55			0.45			A
	Conditions	VIN=10V			VIN=18V			VIN=8V			VIN=21V			

(Ta=25°C)

Parameter	Symbol	Ratings												Unit			
		SI-8501L			SI-8502L			SI-8503L			SI-8504L				SI-8505L		
		min.	typ.	max.	min.	typ.	max.	min.	typ.	max.	min.	typ.	max.		min.	typ.	max.
Output Voltage	Vo	4.80	5.00	5.20	11.40	12.00	12.60	3.17	3.30	3.43	8.55	9.00	9.45	14.25	15.00	15.75	V
	Conditions	VIN=20V, Io=0.5A			VIN=24V, Io=0.5A			VIN=15V, Io=0.5A			VIN=21V, Io=0.5A			VIN=25V, Io=0.5A			
Efficiency	η		83			89			79			87		90		%	
	Conditions	VIN=20V, Io=0.5A			VIN=24V, Io=0.5A			VIN=15V, Io=0.5A			VIN=21V, Io=0.5A			VIN=25V, Io=0.5A			
Switching Frequency	f		60			60			60			60		60		kHz	
	Conditions	VIN=20V, Io=0.5A			VIN=24V, Io=0.5A			VIN=15V, Io=0.5A			VIN=21V, Io=0.5A			VIN=25V, Io=0.5A			
Line Regulation	ΔV _{OLINE}		70	130		70	130		50	80		70	130		70	130	mV
	Conditions	VIN=10 to 30V, Io=0.5A			VIN=18 to 30V, Io=0.5A			VIN=8 to 30V, Io=0.5A			VIN=15 to 30V, Io=0.5A			VIN=21 to 30V, Io=0.5A			
Load Regulation	ΔV _{OLOAD}		30	55		30	55		20	45		30	55		30	55	mV
	Conditions	VIN=20V, Io=0.2 to 0.8A			VIN=24V, Io=0.2 to 0.8A			VIN=15V, Io=0.2 to 0.8A			VIN=21V, Io=0.2 to 0.8A			VIN=25V, Io=0.2 to 0.8A			
Temperature Coefficient of Output Voltage	ΔVo/ΔTa		±0.5			±1.5			±0.5			±1.0		±1.5		mV/°C	
Switching Ripple Voltage (C ₂ =470μF)	ΔV _r		45			30			15			25		30		mV _{p-p}	
	Conditions	VIN=20V, Io=0.5A			VIN=24V, Io=0.5A			VIN=15V, Io=0.5A			VIN=21V, Io=0.5A			VIN=25V, Io=0.5A			
Overcurrent Protection Starting Current	Is1	1.1			1.1			1.1			1.1			1.1		A	
	Conditions	VIN=18V			VIN=24V			VIN=12V			VIN=21V			VIN=25V			

■External Dimensions

(unit:mm)

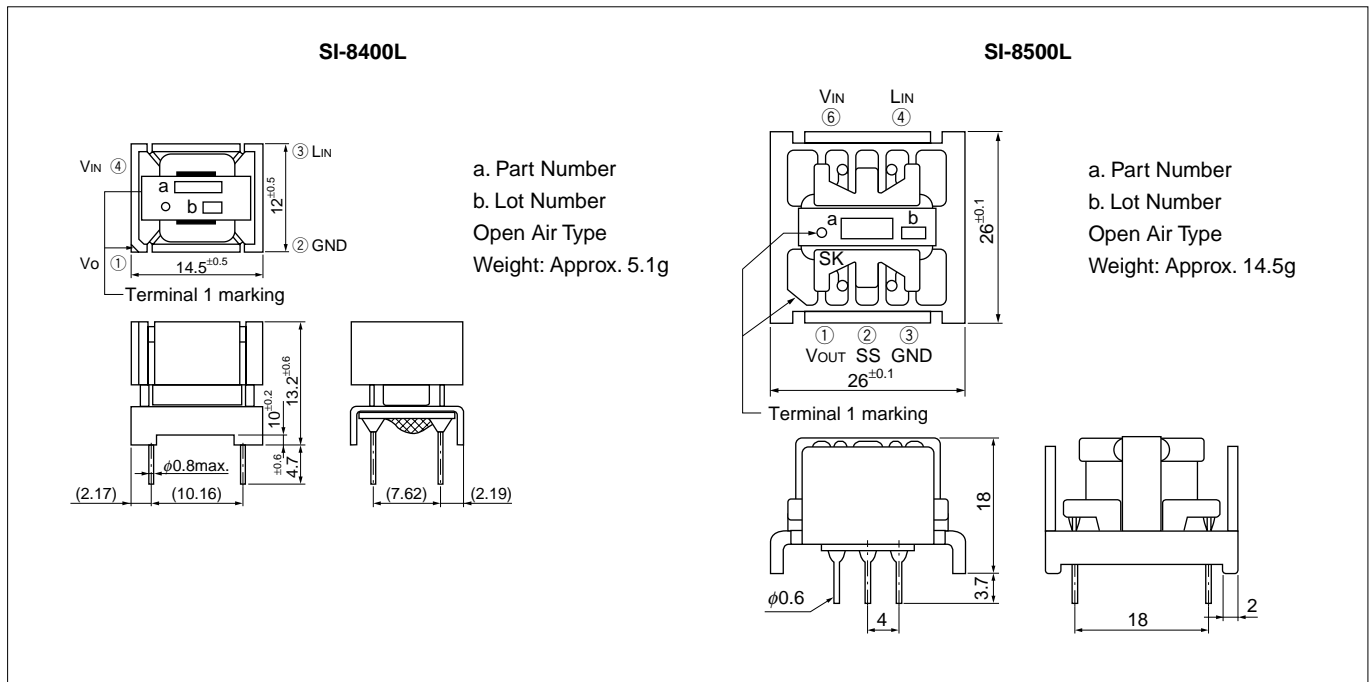

■Block Diagram

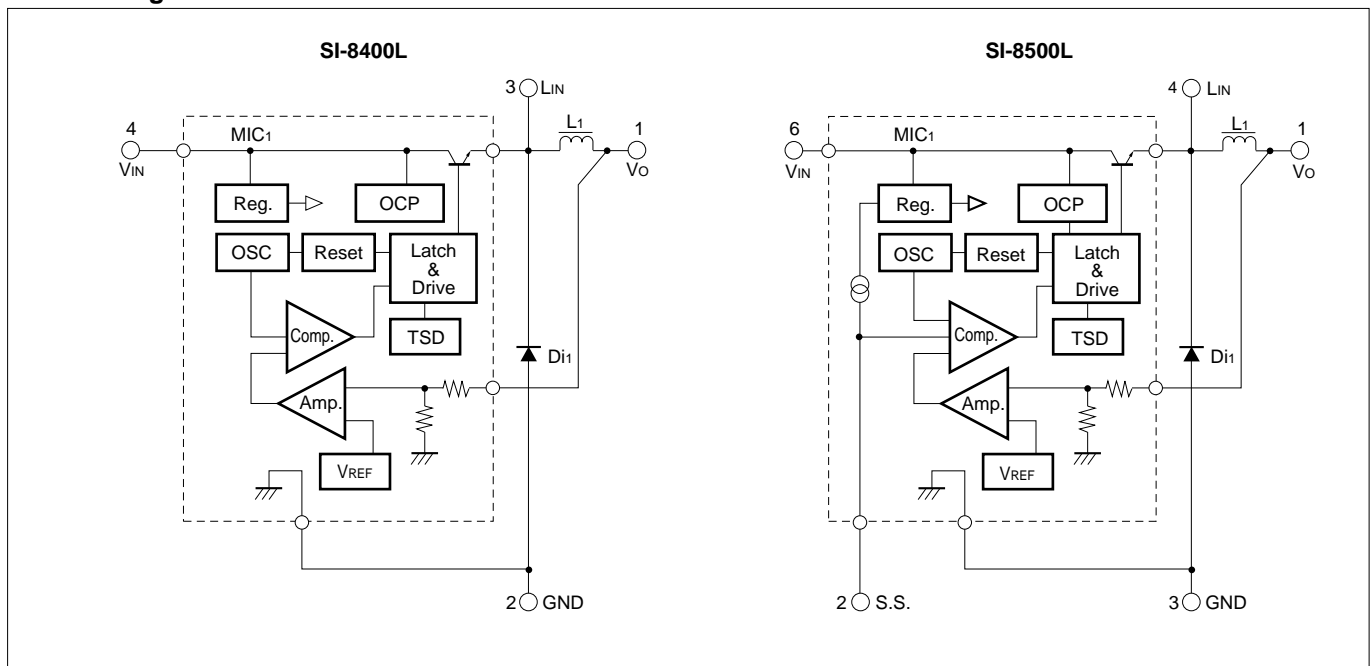

■Standard External Circuit

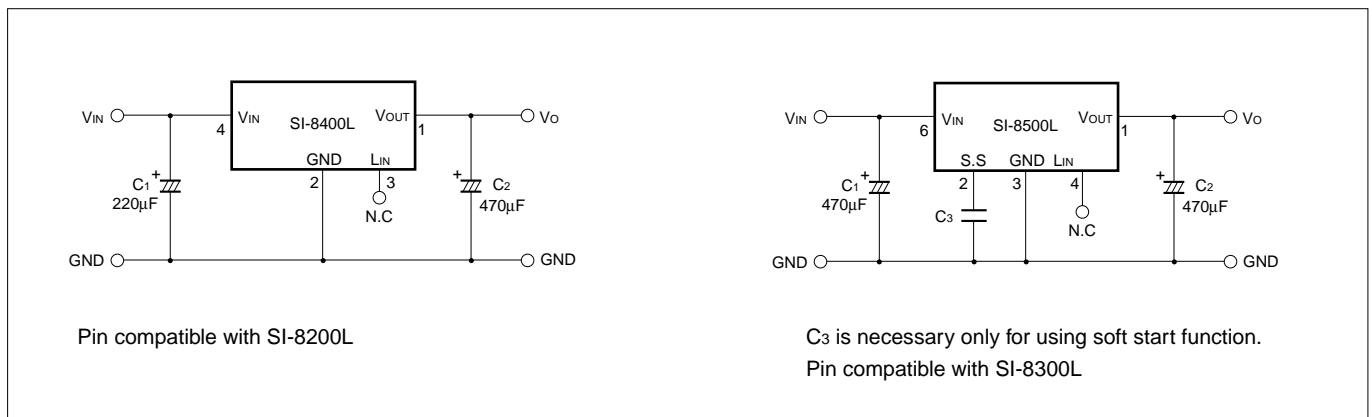

■**T_a-P_D Characteristics**

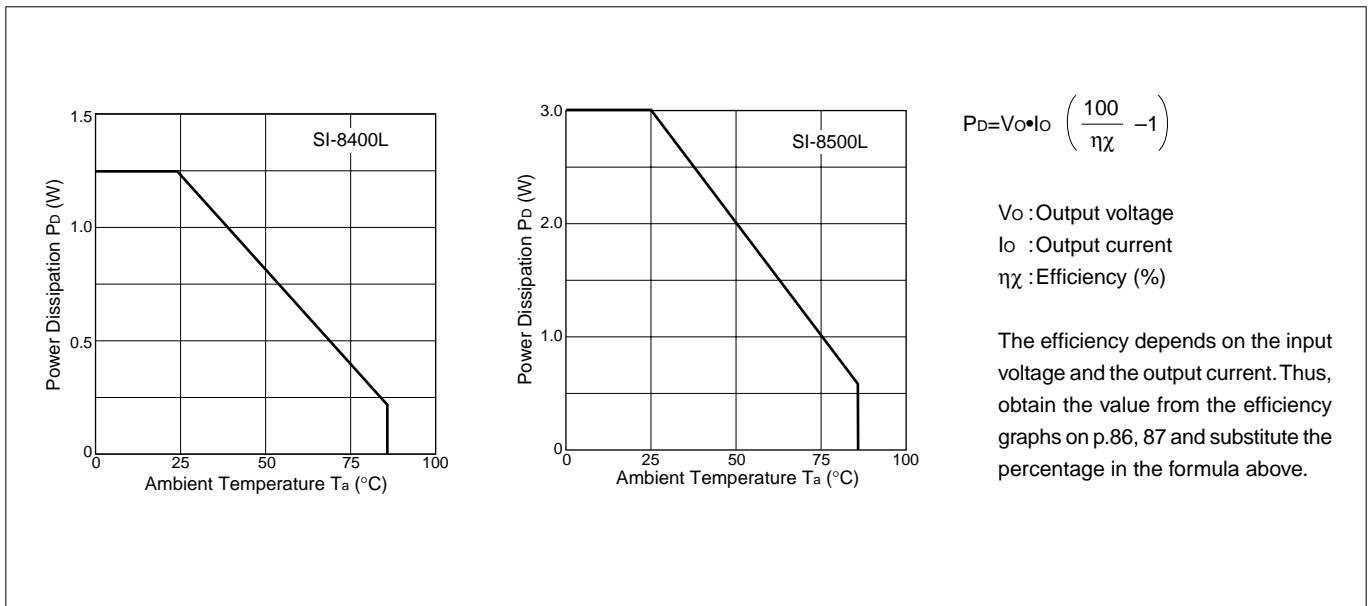

■**SI-8500L application circuit**

Terminal no.2 is for soft start. Connecting a capacitor to the terminal enables the soft start function. See page 77 for the formulas to calculate delay time and rise time. Output can be turned on and off by using the soft start terminal. To stop output, set the soft start terminal voltage to V_{SSL} (0.2V typ.) or less. To switch the potential of the soft start terminal, drive the open collector of the transistor. Since the discharge current from C₃ flows to the ON/OFF control transistor, limit the current for protection. The SS terminal is pulled up to the power supply in the IC and no external voltage can be applied.

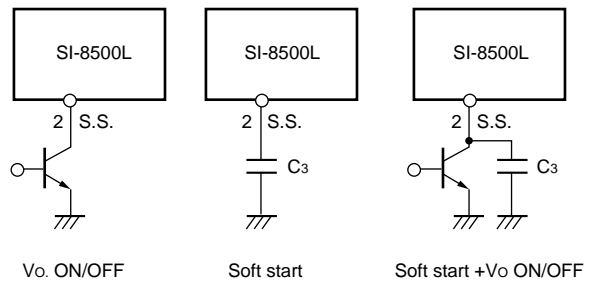

■**Caution**

1. Allocation of Components

For the best operating environment, the ground should be a single ground line at the GND terminal (terminal 2 on the SI-8400L, terminal 3 on the SI-8500L), and the wiring from C₁ and C₂ to ground should be as short as possible.

2. Capacitors C₁ and C₂

1) They must satisfy the breakdown voltage and allowable ripple current.

Exceeding the ratings of these capacitors or using them without derating shortens their service lives and may also cause abnormal oscillation of the IC.

2) C₂ must be a low-impedance type capacitor to ensure minimum ripple voltage and stable switching operation.

3) C₃ (SI-8500L only) is a capacitor for soft start. When not using soft start, leave terminal 2 open. It is pulled up inside the IC.

3. Terminals L_{IN} and NC in the connection diagram must be left unconnected to other circuits.

4. The IC's metallic heatsink is electrically floating. Do not connect it to GND or any other circuit.

5. Since the SI-8400L and 8500L series have an open-package construction, they can only be operated in specific environments. Verify the operating environment and use the conditions indicated in the reliability data.

■Typical Characteristics (SI-8400L Series)

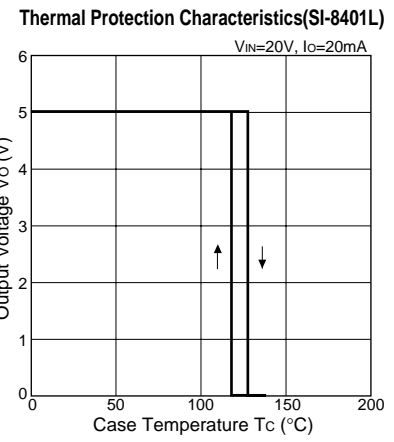
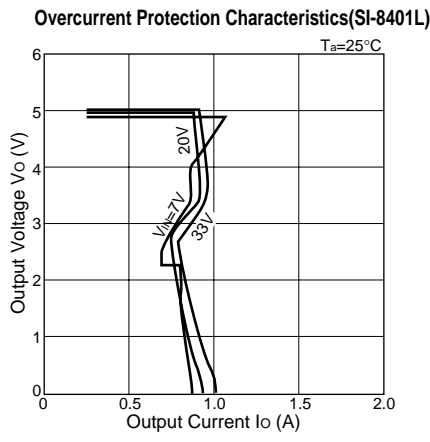
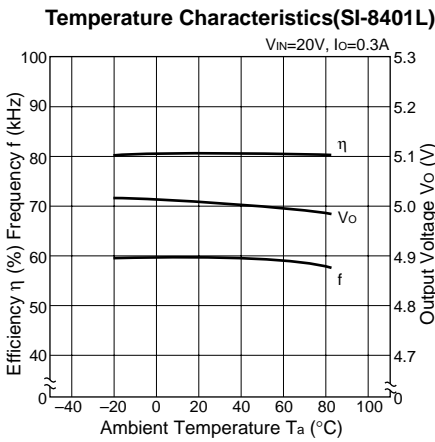
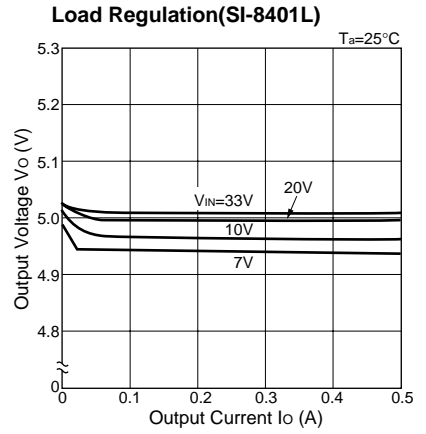
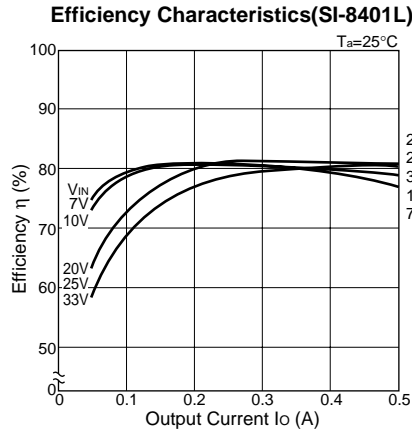
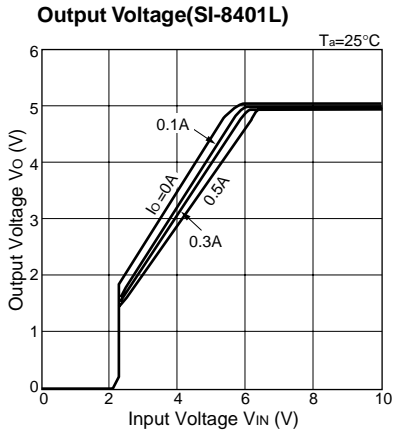

Note on Thermal Protection:

The thermal protection circuit is intended for protection against heat during instantaneous short-circuiting. Its operation is not guaranteed for continuous heating condition such as short-circuiting over extended periods of time.

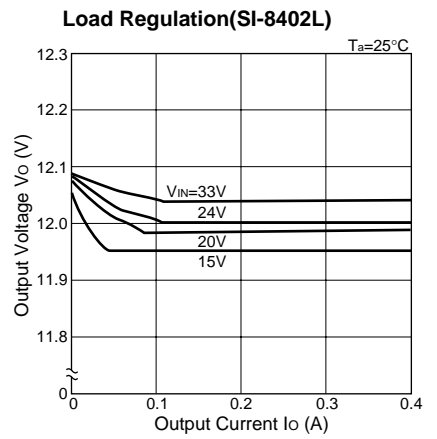
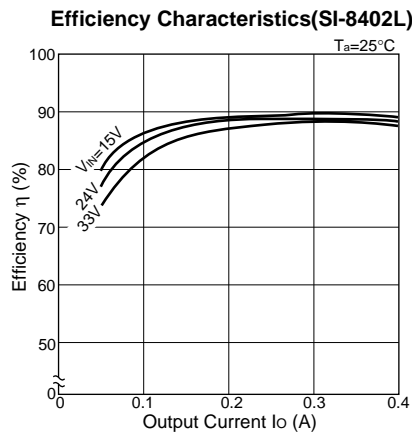
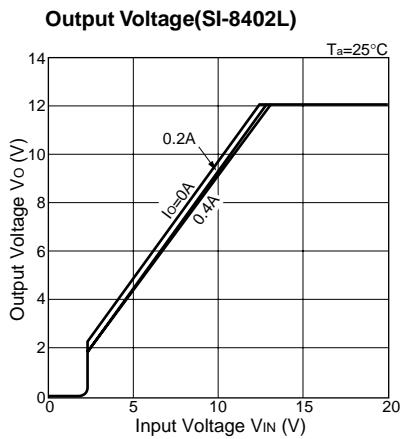

Typical Characteristics (SI-8500L Series)

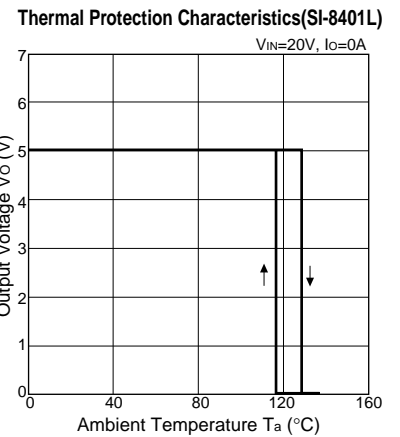
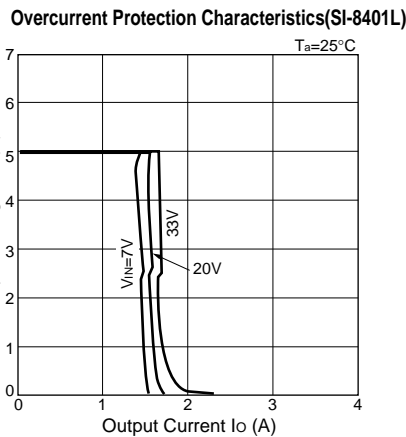
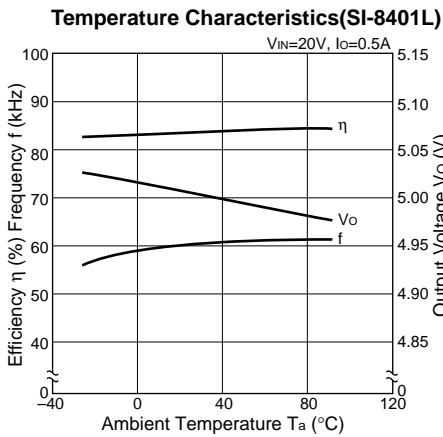
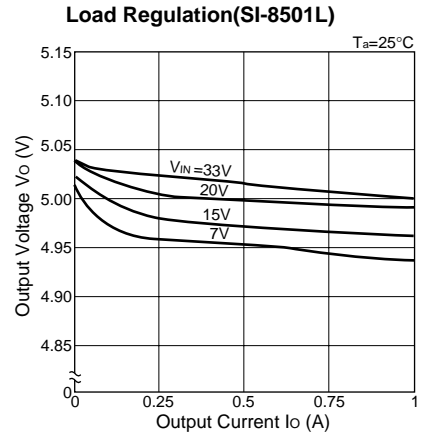
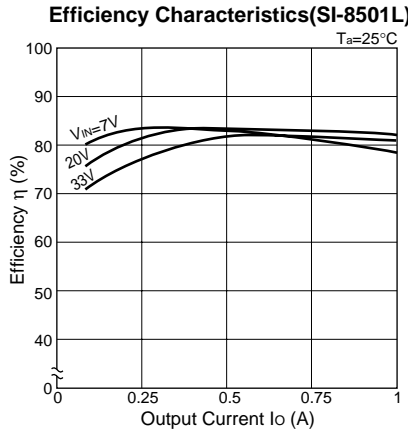
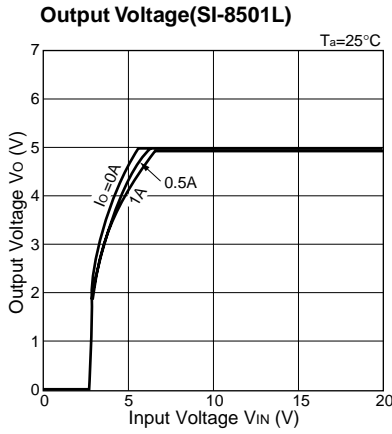

Note on Thermal Protection:

The thermal protection circuit is intended for protection against heat during instantaneous short-circuiting. Its operation is not guaranteed for continuous heating condition such as short-circuiting over extended periods of time.

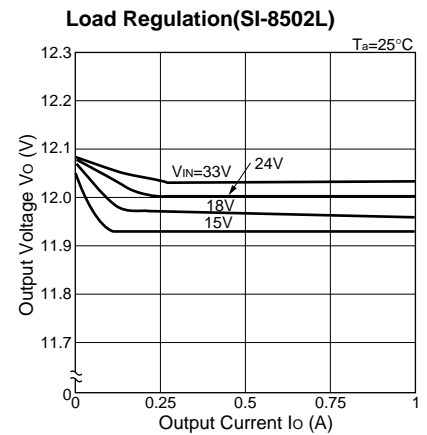
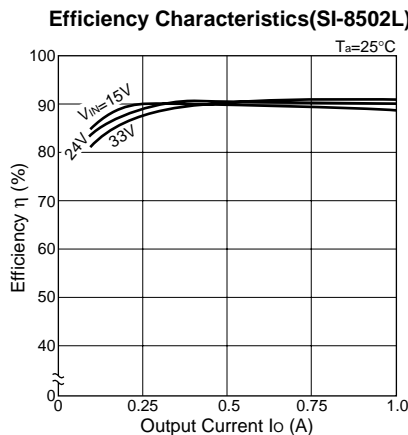
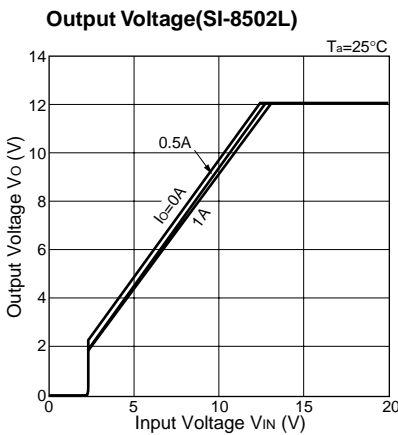

SI-8800L/8900L Series

Separate Excitation Switching Type with Transformer

■Features

- Integrated switching IC and transformer construction
- Requires only input/output and soft start capacitors as external components
- Low switching noise
- Heatsink not required
- Built-in overcurrent protection circuit (+5V)
- Both plus and minus output models available (SI-8811L, SI-8911L)

■Applications

- Telephone power supplies
- Onboard local power supplies

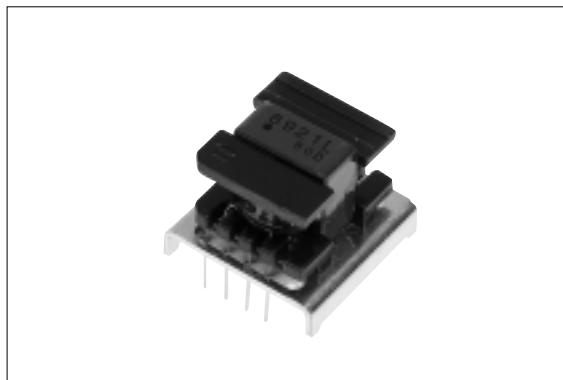

■Lineup

Part Number	Ch1		Ch2	
	Vo(V)	Io(A)	Vo(V)	Io(A)
SI-8811L	+5	0.45	-5	0.05
SI-8911L	+5	0.3	-5	0.1
SI-8921L/8922L	+5	0.6		

■Absolute Maximum Rating

Parameter	Symbol	Ratings				Unit
		SI-8811L	SI-8911L	SI-8921L	SI-8922L	
DC Input Voltage	V _{IN}	35	60			V
Power Dissipation	P _D	1.15	1.3	1.67	1.67	W
Junction Temperature	T _j	+100				°C
Storage Temperature	T _{stg}	-25 to +85				°C

■Recommended Operating Conditions

Parameter	Symbol	Ratings												Unit
		SI-8811L			SI-8911L			SI-8921L			SI-8922L			
		min.	typ.	max.	min.	typ.	max.	min.	typ.	max.	min.	typ.	max.	
DC Input Voltage Range	V _{IN}	12	20	30	24	40	55	24	40	55	20	40	55	V
Output Current Range 1	I _{O1}	50	250	450	20	150	300 ^{*2}	0	300	600	0	300	600	mA
Output Current Range 2	I _{O2}	0	-20	-50 ^{*1}	0	-50	-100							mA
Operating Temperature Range	T _{op}	-10		+70	-10		+60	-10		+65	-10		+65	°C

*1: Output current 2 depends on the input/output conditions

*2: If I_{O2}≥50mA or more, the condition I_{O1}>0.5×I_{O2} is recommended.

■Electrical Characteristics

(Ta=25°C)

Parameter	Symbol	Ratings												Unit	
		SI-8811L			SI-8911L			SI-8921L			SI-8922L				
		min.	typ.	max.	min.	typ.	max.	min.	typ.	max.	min.	typ.	max.		
Output Voltage 1	Vo1	4.75	5.00	5.25	4.75	5.00	5.25	4.95	5.10	5.20	4.95	5.10	5.20	V	
	Conditions	Recommended operating conditions													
Output Voltage 2	Vo2	-4.75	-5.00	-5.25	-4.75	-5.00	-5.25	—			—			V	
	Conditions	Recommended operating conditions													
Efficiency	η	72			65			72			72			%	
	Conditions	Recommended operating conditions (typ.)													
Switching Frequency	f	50			68			60	68	80	60	68	80	kHz	
Switching Ripple Voltage 1	ΔVr1	50			50			50	80	—			mVp-p		
	Conditions	Recommended operating conditions (typ.)													
Switching Ripple Voltage 2	ΔVr2	50			50			—			—			mVp-p	
	Conditions	Recommended operating conditions (typ.)													
Operation Starting Voltage	Vst	—			22	24			22	24		17	20		V
	Conditions	Recommended operating conditions (typ.)													

■External Dimensions

(unit: mm)

SI-8811L, 8911L, 8921L, 8922L

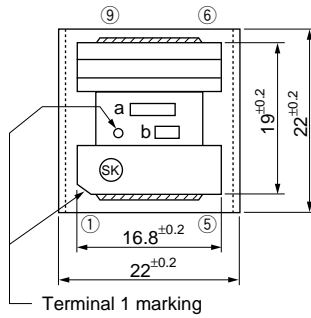

a. Part Number
b. Lot Number

Open Air Type
Weight: Approx. 9.3g

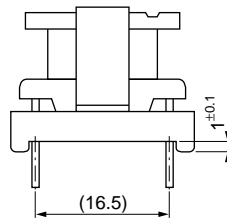
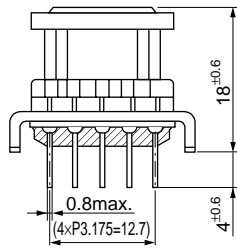

■Block Diagram

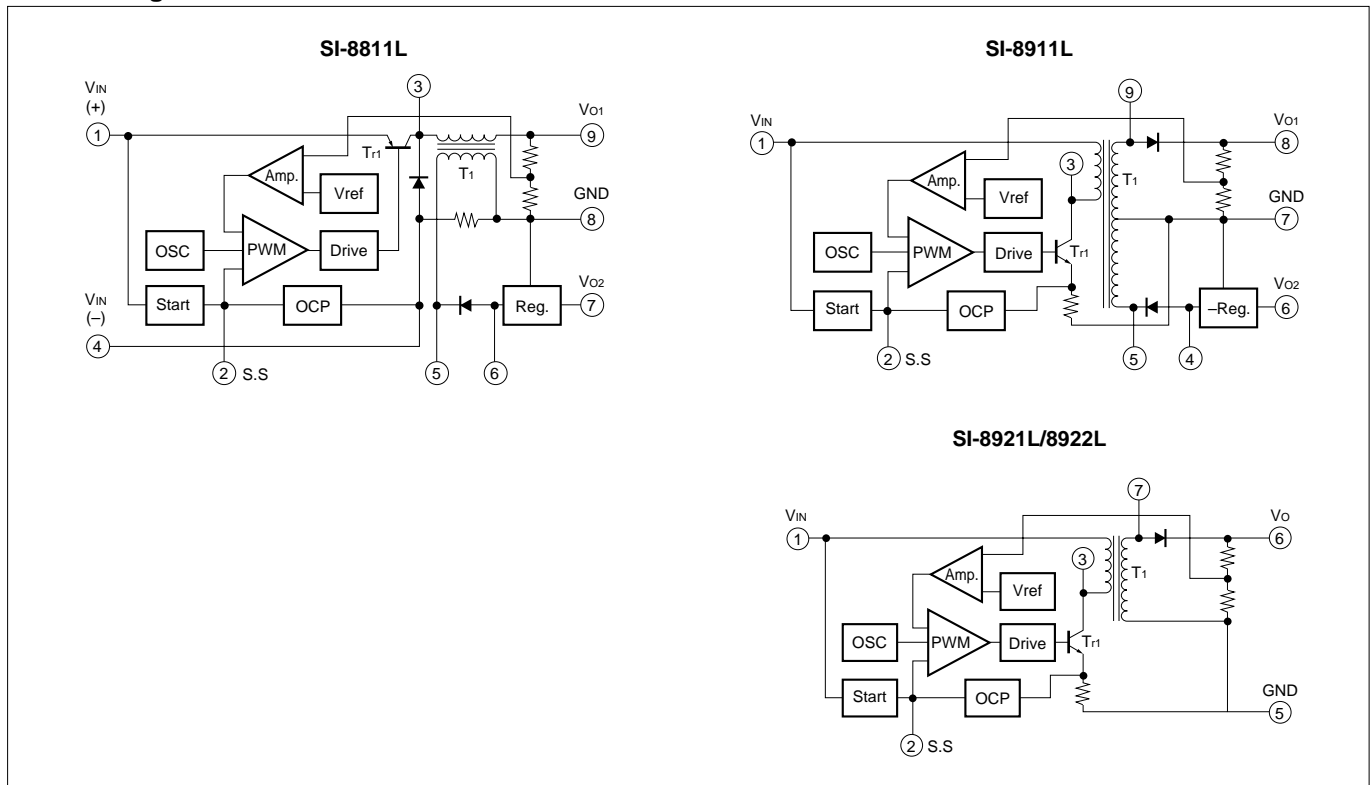

■Standard External Circuit

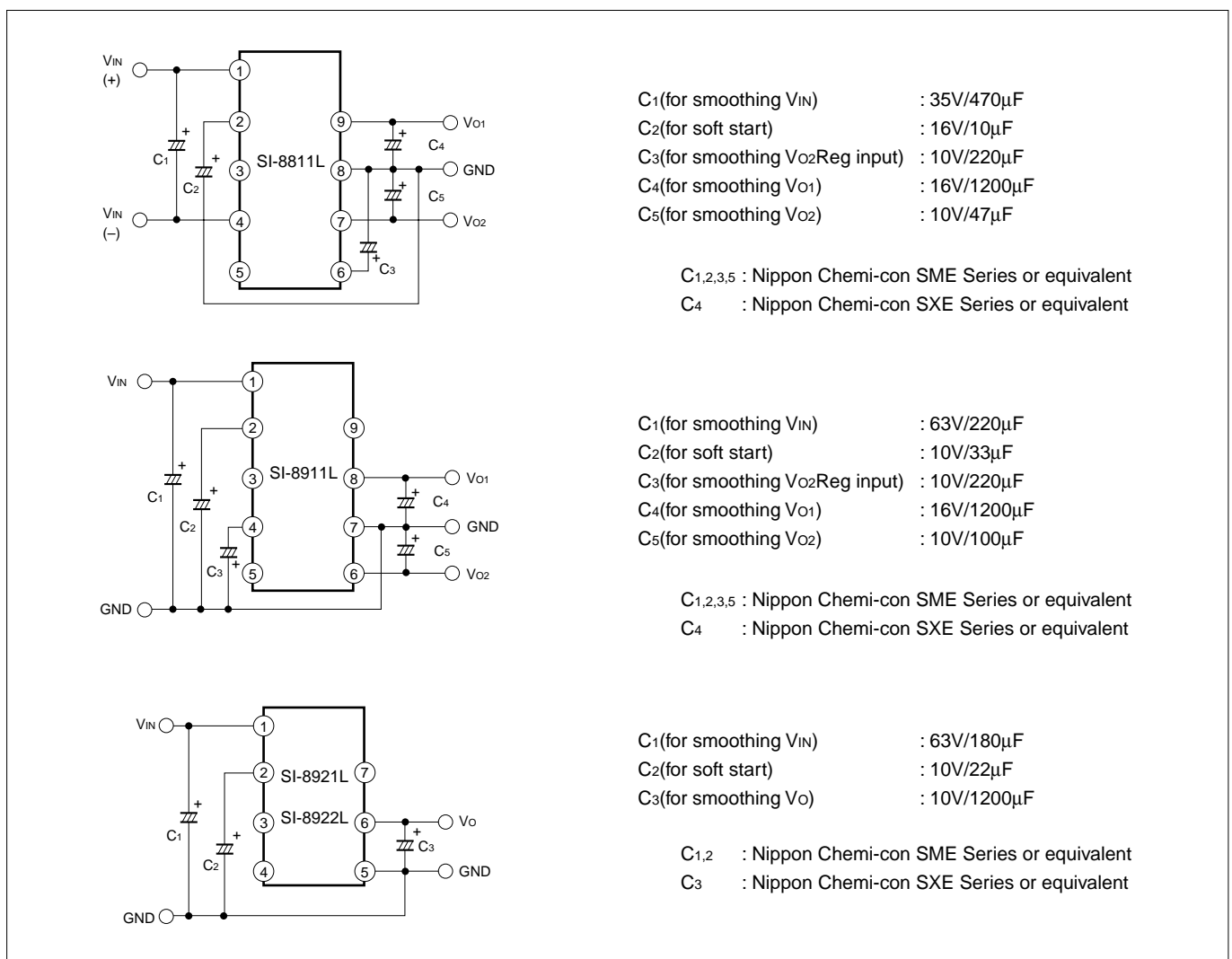

■**T_a-P_D Characteristics**

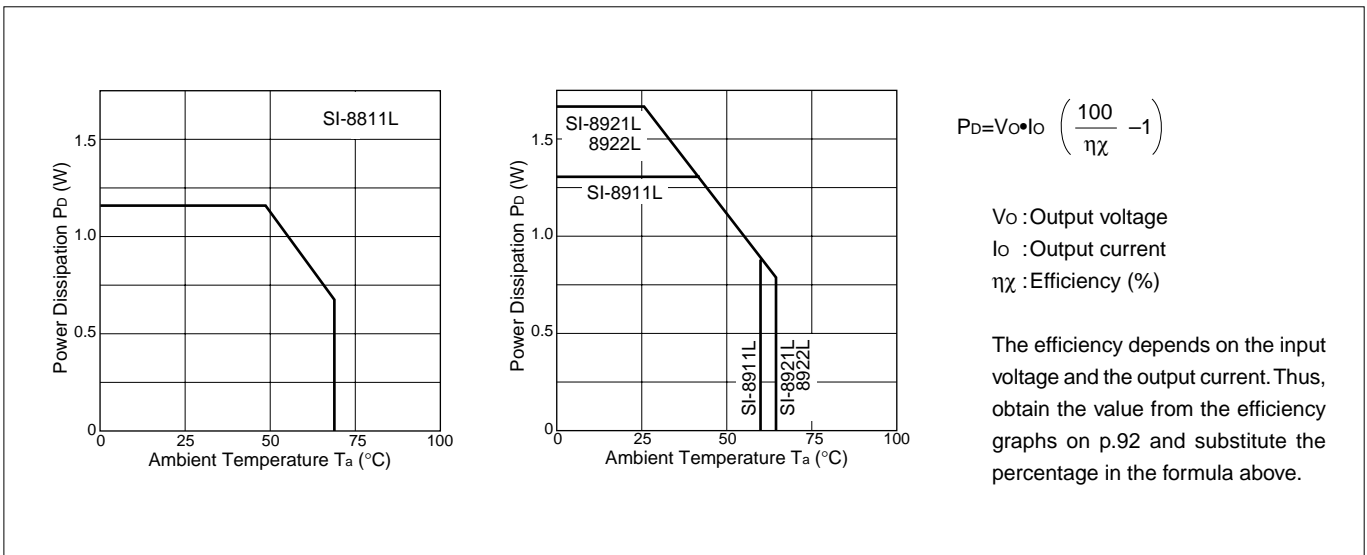

■**Caution**

1. A low-impedance capacitor suitable for switching applications must be used for the external capacitor and must be connected as close to the IC as possible in order to assure low ripple voltage and stable switching operation.
2. The SI-881L/8911L series does not have a built-in overcurrent protection circuit on V_{O2}(-5V). Thus, avoid short-circuit conditions that may cause an overcurrent.
3. Do not connect V_{IN}(-) of SI-8811L to GND. The overcurrent protection circuit may not work if they are connected.
4. Terminals left unconnected in the connection diagram must not be connected to other circuits.
5. The IC's metallic heatsink is electrically floating. Do not connect it to GND or any other circuit.
6. Since the SI-8800L and 8900L series have an open-package construction, they can be operated in specific environments. Verify the operating environment and use the IC within the conditions indicated in the reliability data.

■Typical Characteristics

($T_a=25^\circ\text{C}$)

SI-8811L

Output Voltage

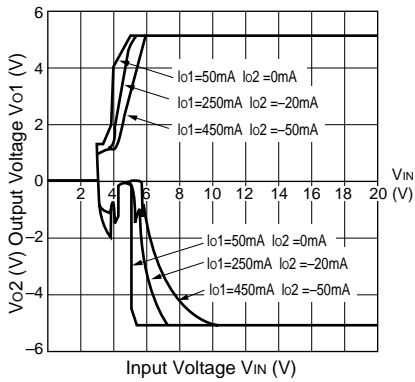

Efficiency Characteristics

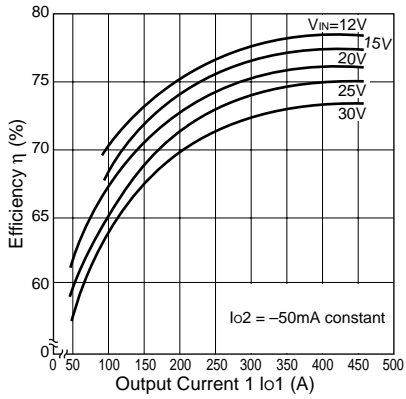

SI-8911L

Output Voltage

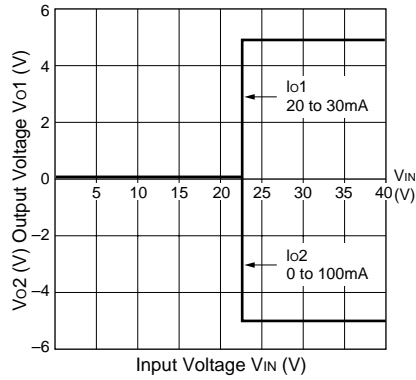

Efficiency Characteristics

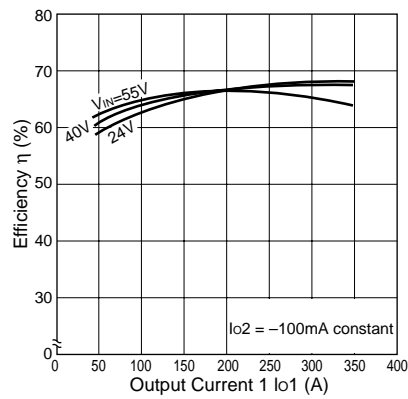

SI-8921L

Output Voltage

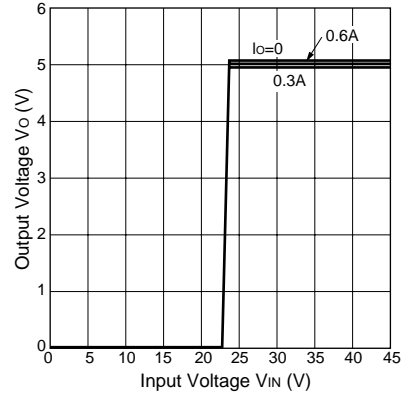

Efficiency Characteristics

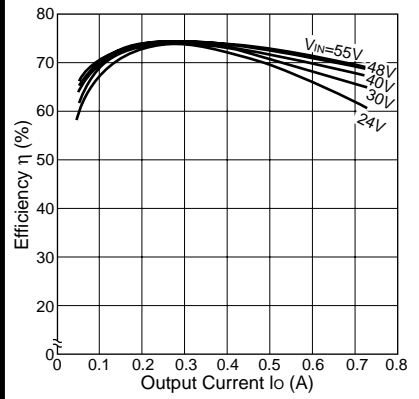

SI-8922L

Output Voltage

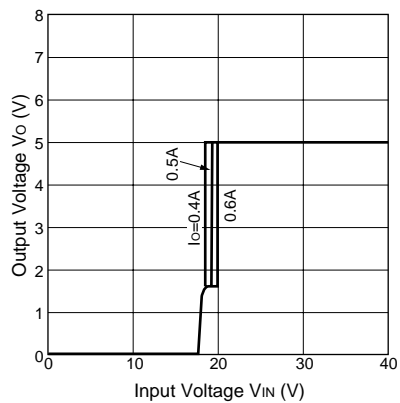

Efficiency Characteristics

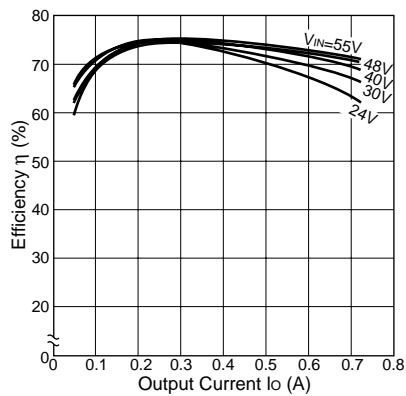

Multi-Output Type - Application Note

■Heat Radiation and Reliability

The reliability of an IC is highly dependent on its operating temperature. Design should pay particular attention to ensuring ample space for radiating heat.

Be sure to apply silicon grease to the IC before attaching a heatsink, and to secure it firmly to the heatsink.

Other important items to be considered regarding heat radiation include air convection during operation.

The reliability of peripheral components such as capacitors and coils is closely related to temperature. A high operating temperature may reduce the service life. Exceeding the allowable temperature may burn the coils or damage capacitors. It is important to make sure that the temperature of output smoothing coils and input/output capacitors do not exceed their allowable levels during operation. Allow for variation in the ratings of the coils and minimize heat emission as far as possible. (For peripheral components, refer to the user manuals.)

■Heatsink Design

The maximum junction temperature $T_{j(max)}$ given in the absolute maximum ratings is specific to each product type and must be strictly observed. Thus, thermal design must consider the conditions of use which affect the maximum power dissipation $P_{D(max)}$ and the maximum ambient temperature $T_{a(max)}$.

To simplify thermal design, the relationship between these two parameters has been presented in a graph, the T_a - P_D characteristic graph. Thermal design should include these steps:

1. Obtain the maximum ambient temperature $T_{a(max)}$.
2. Obtain the maximum power dissipation $P_{D(max)}$.
3. Look for the intersection point on the T_a - P_D characteristic graph and determine the size of the heatsink.

The size of the heatsink has now been obtained. However, in actual applications, a 10 to 20% derating factor is introduced. Moreover, the heat dissipation capacity of a heatsink highly depends on how it is mounted. Thus, it is recommended to measure the heatsink and case temperature in the actual operating environment.

The T_a - P_D characteristics for each product type are provided for reference purposes.

■Fastening Torque

STA800M Series (when using a spring)

0.588 to 0.784 [N•m](6.0 to 8.0[kgf•cm])

SLA3000M Series

0.588 to 0.784 [N•m](6.0 to 8.0[kgf•cm])

■Recommended Silicon Grease

- Shin-Etsu Chemical Co., Ltd.: G746
- GE Toshiba Silicone Co., Ltd.: YG-6260
- Dow Corning Toray Silicone Co., Ltd.: SC102

Please be careful when selecting silicone grease since the oil in some grease may penetrate the product, which will result in an extremely short product life.

STA801M/802M

2-Output Separate Excitation Switching Type

■Features

- 2 regulators combined 1 package
- Compact inline package
- Output current (0.5A × 2 output)
- Output voltage of Ch2 selectable from 4 levels.
- Built-in flywheel diode (Schottky barrier diode)
- Requires only 7 external components (2 outputs)
- Phase correction and output voltage adjustment performed internally
- Built-in reference oscillator (125kHz) - Compact choke coil can be used due to high frequency (compared to existing Sanken product)
- Built-in overcurrent and thermal protection circuits
- Built-in soft start circuit (Output ON/OFF control)

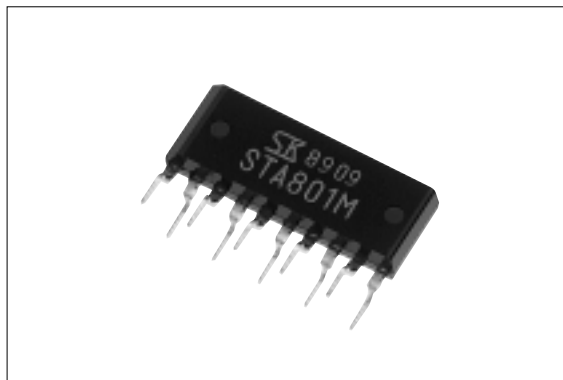

■Applications

- For BS and CS antenna power supplies
- For stabilization of the secondary stage of switching power supplies
- Electronic equipment

■Lineup

Part Number	Output Voltage (V)	
	Ch1	Ch2(Select one output)
STA801M	5	9.0 / 11.5 / 12.1 / 15.5
STA802M	9	9.1 / 11.7 / 12.1 / 15.7

■Absolute Maximum Ratings

Parameter	Symbol	Ratings	Unit
DC Input Voltage	V _{IN}	43	V
Power Dissipation	P _{D1}	6.7(With infinite heatsink)	W
	P _{D2}	1.6(Without heatsink, stand-alone operation)	W
Junction Temperature	T _j	+125	°C
Storage Temperature	T _{stg}	-40 to +125	°C

■Recommended Operating Conditions

Parameter	Symbol	Ratings		Unit
		min.	max.	
DC Input Voltage Range	V _{IN}	Ch2 V _{Omax.} +2	40	V
Output Current Range per Channel	I _O	0	0.5	A
Operating Temperature Range	T _{top}	-20	+125	°C

■ Electrical Characteristics

(Ta=25°C)

	Parameter	Symbol	Ratings						Unit	
			STA801M			STA802M				
			min.	typ.	max.	min.	typ.	max.		
Ch1	Output voltage 1	Vo1	4.80	5.00	5.20	8.64	9.00	9.36	V	
		Conditions	VIN=20V, Io=0.3A			VIN=20V, Io=0.3A				
	Efficiency *	η1		80			86		%	
		Conditions	VIN=20V, Io=0.3A			VIN=20V, Io=0.3A				
	Temperature Coefficient of Output Voltage	ΔVo/ΔTa1		±0.5			±1.0		mV/°C	
	Line Regulation	ΔVLINE1		30	90		35	110	mV	
	Conditions	VIN=10 to 30V, Io=0.3A			VIN=14 to 30V, Io=0.3A					
Load Regulation	ΔVLOAD1		10	40		20	80	mV		
	Conditions	VIN=20V, Io=0.1 to 0.4A			VIN=20V, Io=0.1 to 0.4A					
Ch2 (Select one output)	Output voltage 2-1	Vo2-1	8.64	9.00	9.36	8.74	9.10	9.46	V	
		Conditions	VIN=20V, Io=0.3A			VIN=20V, Io=0.3A				
	Output voltage 2-2	Vo2-2	11.04	11.50	11.96	11.24	11.70	12.16	V	
		Conditions	VIN=20V, Io=0.3A			VIN=20V, Io=0.3A				
	Output voltage 2-3	Vo2-3	11.62	12.10	12.58	11.62	12.10	12.58	V	
		Conditions	VIN=20V, Io=0.3A			VIN=20V, Io=0.3A				
	Output voltage 2-4	Vo2-4	14.88	15.50	16.12	15.08	15.70	16.32	V	
		Conditions	VIN=20V, Io=0.3A			VIN=20V, Io=0.3A				
	Vo2-4	Efficiency*	η		89			89		%
			Conditions	VIN=20V, Io=0.3A			VIN=20V, Io=0.3A			
		Temperature Coefficient of Output Voltage	ΔVo/ΔTa		±2.0			±2.0		mV/°C
		Line Regulation	ΔVLINE		40	130		40	130	mV
		Conditions	VIN=20 to 30V, Io=0.3A			VIN=20 to 30V, Io=0.3A				
	Load Regulation	ΔVLOAD		30	120		30	120	mV	
	Conditions	VIN=20V, Io=0.1 to 0.4A			VIN=20V, Io=0.1 to 0.4A					
Common	No-load Circuit Current	Icc		15			15		mA	
	Switching Frequency	f		125			125		kHz	
	Overcurrent Protection Starting Current	Is1	0.51	0.7		0.51	0.7		A	

*Efficiency indicates the value when only one channel is active. The value can be calculated as shown below. 7.5mA is deducted for the no-load circuit current of $\frac{I_{cc}}{2}$ at unused output.

$$\eta = \frac{V_o \cdot I_o}{V_{IN} \cdot (I_{IN} - 0.0075)} \times 100(\%)$$

■ External Dimensions

(unit:mm)

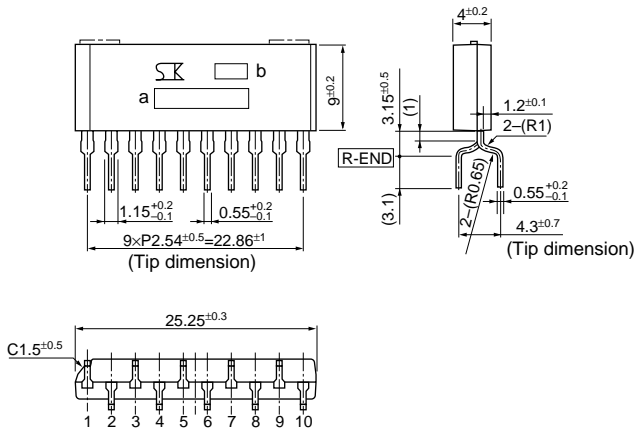

- a. Part Number
- b. Lot Number

Pin Arrangement

- | | |
|------------|----------|
| ① VO2 Cont | ⑥ VIN |
| ② Vos1 | ⑦ SWOUT2 |
| ③ SS1 | ⑧ SS2 |
| ④ SWOUT1 | ⑨ Vos2-2 |
| ⑤ GND | ⑩ Vos2-1 |

Plastic Mold Package Type
 Flammability: UL94V-0
 Weight: Approx. 2.5g

■ Block Diagram

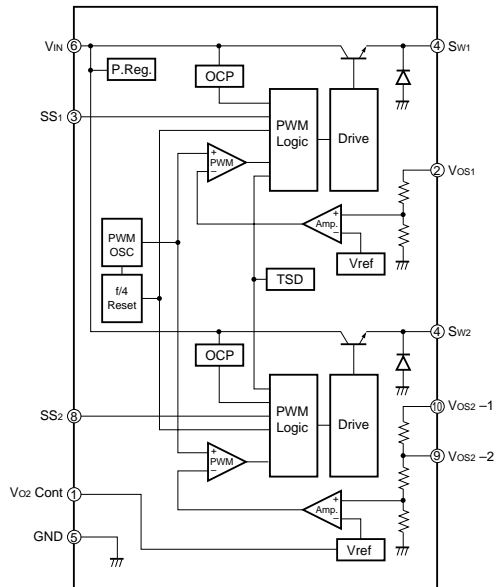

■Standard External Circuit

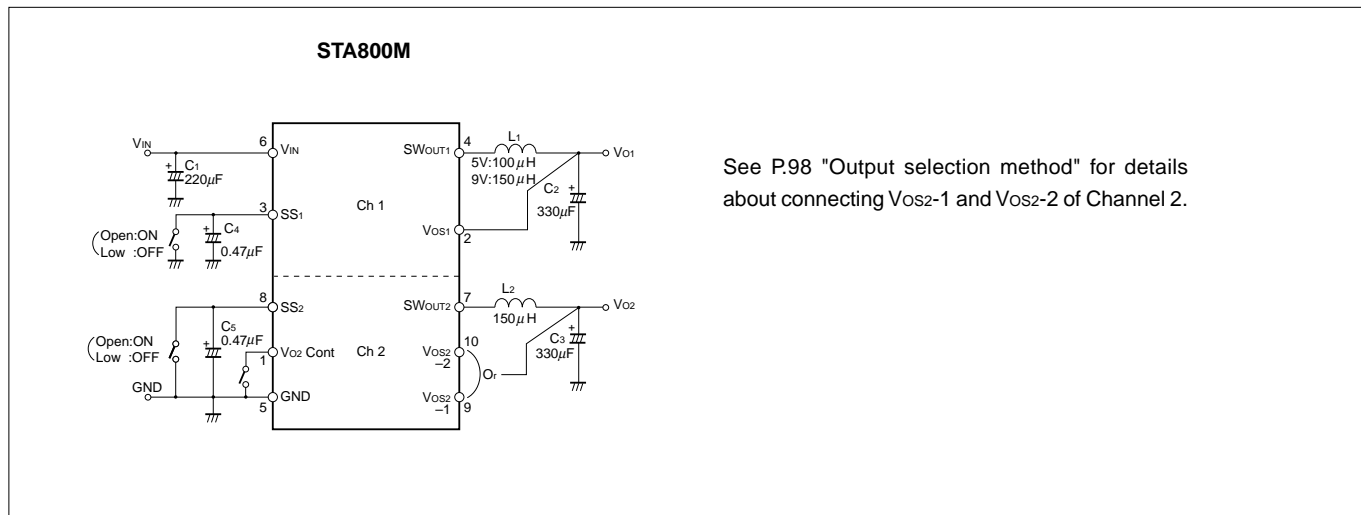

■Ta-Pd Characteristics

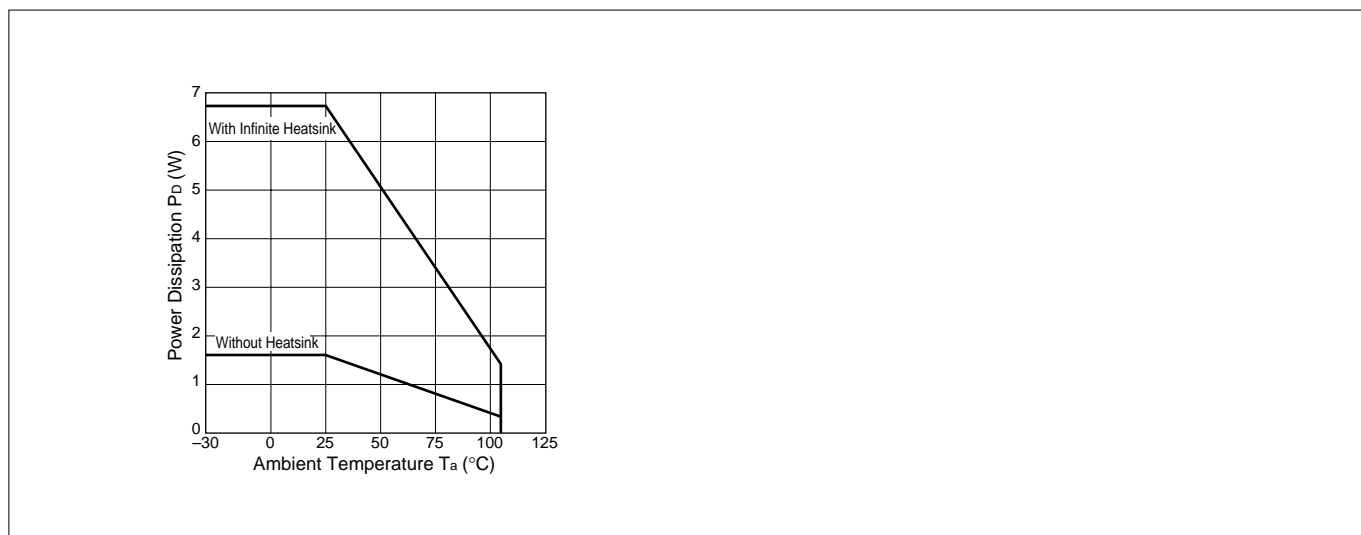

■Selecting External Components

1. Inductors L1 and L2

(1) Suitable for switching regulators

Do not use a coil as a noise filter because it generates excess heat.

(2) Appropriate inductance

A low inductance may cause abnormal oscillation, or cause the overcurrent protection circuit to malfunction in the rated current range.

(3) Satisfying the rated current

Exceeding the rated current may generate an extremely high current to flow due to magnetic saturation.

2. Capacitors C1, C2, and C3

(1) Satisfy the breakdown voltage and allowable ripple current

Exceeding the ratings of these capacitors or using them without derating may shorten their service lives and also cause abnormal oscillation.

(2) Low impedance (C2, and C3)

A low-impedance model is recommended for C2 and C3 to reduce the ripple voltage and stabilize switching. For stable operation throughout the input voltage range, however, the DC equivalent series resistance (ESR) of C2 and C3 should be 0.1 Ω or less.

3. Capacitors C4 and C5

(1) C4 and C5 are soft-start capacitors.

■Selecting Ch2 Output Voltage

When the Vo2Cont terminal voltage is set to 0.5V or less, the output voltage changes to the values shown below. To switch the potential at the Vo2Cont terminal, drive the open collector of the transistor. No external voltage can be applied to the terminal. Leave the terminal open when not in use because the terminal is already pulled up in the IC. When using terminal no. 9, short it to terminal no. 10.

(): STA802M

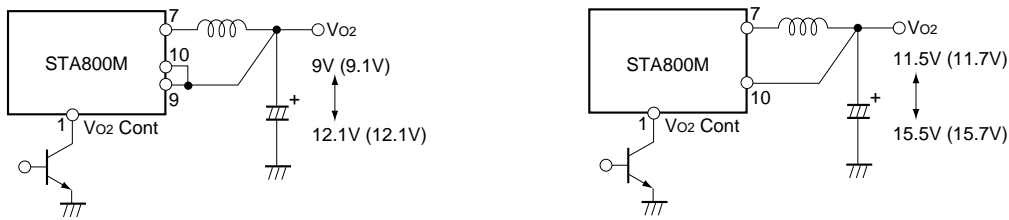

Vo2 output voltage

Vo2 sensing terminal \ Vo2Cont terminal (1 pin)	STA801M		STA802M	
	OPEN	Low	OPEN	Low
9pin	9V	12.1V	9.1V	12.1V
10pin	11.5V	15.5V	11.7V	15.7V

Low : 0.5V or less

■Soft Start ON/OFF Circuit

Terminal nos. 3 and 8 are soft start terminals. Connect a capacitor to the terminal to permit a soft start. Output can be turned on and off by using the soft start terminals. Set the soft start terminal voltage to VSSL (0.15V) or less to stop the output. To switch the potential at the soft start terminals, drive the open collector of the transistor. Since the discharge currents from C4 and C5 flow to the ON/OFF control transistor, limit the current for protection. The SS terminal is pulled up to the power supply in the IC and no external voltage can be applied to the terminal.

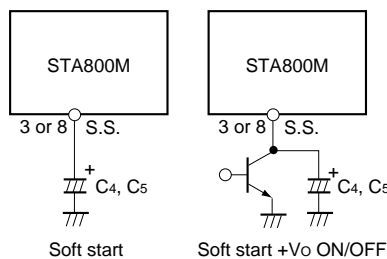

■ Typical Characteristics

($T_a=25^\circ\text{C}$)

STA801M

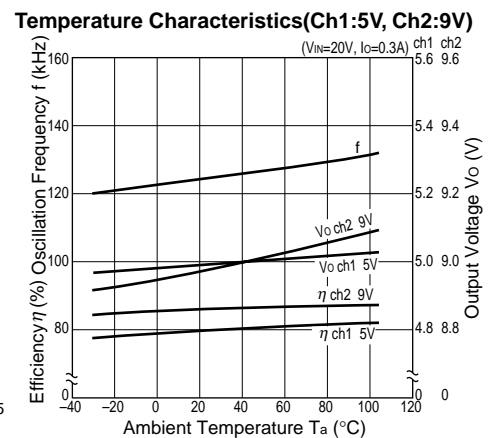
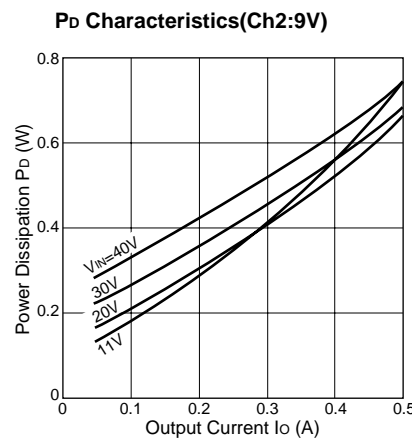
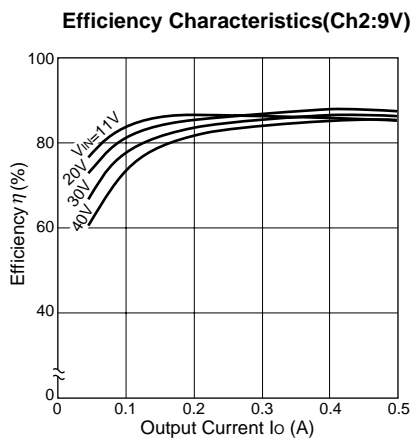
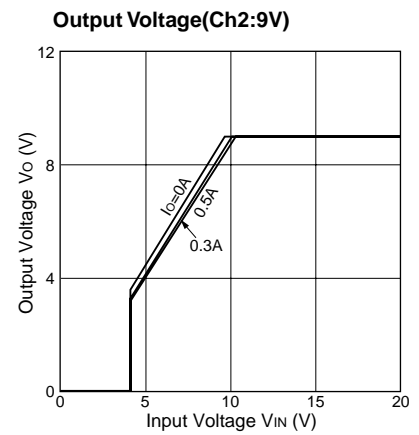
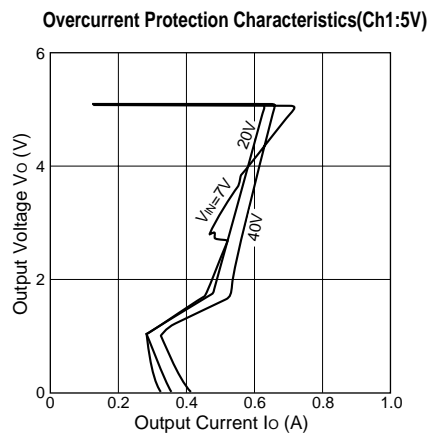
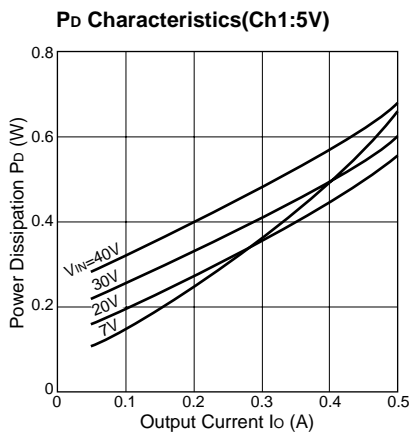
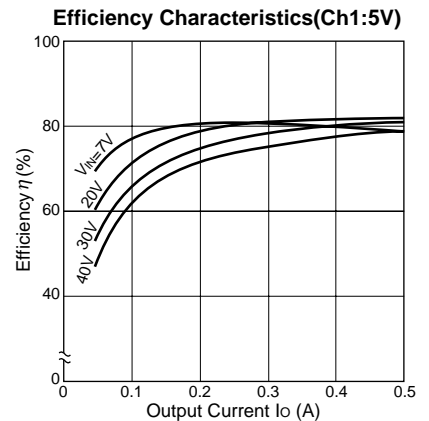
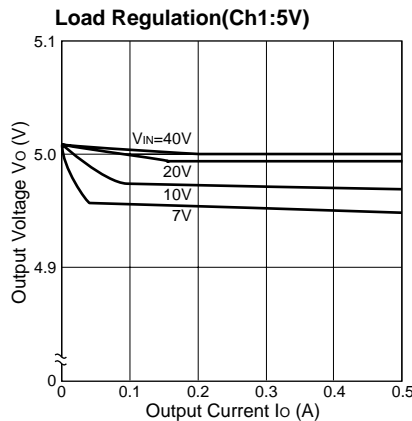
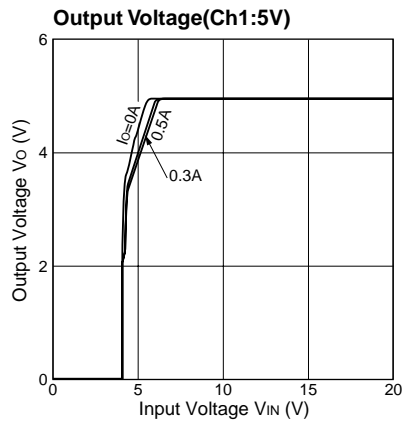

STA802M

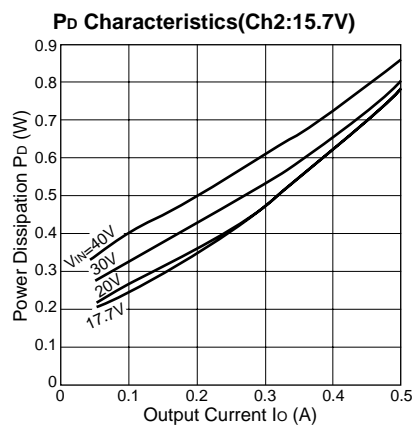
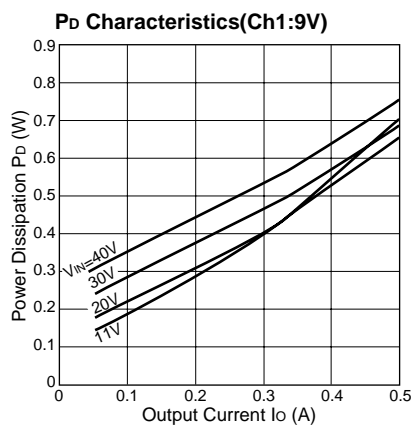
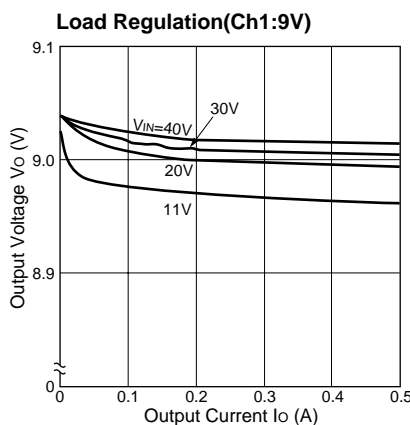

SDI02

2-Output, Low Dropout Voltage Dropper Type for USB

Features

- Two 5V/0.5A output regulators in one package
- Surface-mount 16 pin package
- Low dropout voltage: $V_{DIF} \leq 0.5V$ (at $I_o = 0.5A$)
- Output-independent ON/OFF control terminal compatible with LS-TTL (Active High)
- Built in output-independent overcurrent and thermal protection circuits
- Open collector flag-output terminals built in to output OCP operation to each output terminal (Active Low)
- Built-in anti-malfunction delay circuit whose time can be set with an external capacitor

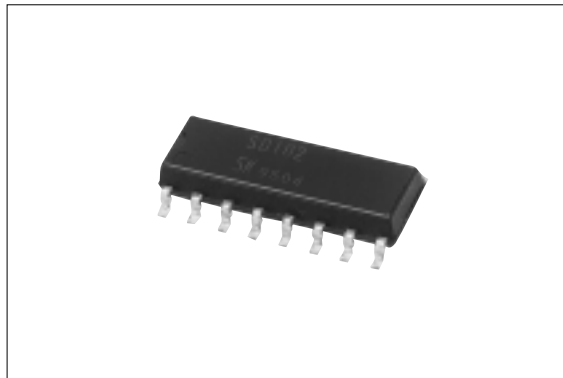

Applications

- USB power supplies
- Electronic equipment

Absolute Maximum Ratings

($T_a=25^\circ C$)

Parameter	Symbol	Ratings	Unit
DC Input Voltage	V_{IN}	18	V
Voltage of Output Control Terminal	V_C	V_{IN}	V
DC Output Current	I_o	0.5	A
Power Dissipation	P_D	3.1*1	W
Junction Temperature	T_j	-30 to +125	$^\circ C$
Ambient Operating Temperature	T_{OP}	-30 to +100	$^\circ C$
Storage Temperature	T_{stg}	-30 to +125	$^\circ C$
Thermal Junction (junction-to-ambient air)	$R_{th(j-a) 1}$	42*2	$^\circ C/W$
	$R_{th(j-a) 2}$	32*1	$^\circ C/W$
Thermal Junction (junction-to-lead)	$R_{th(j-l) 1}$	11*3	$^\circ C/W$
	$R_{th(j-l) 1}$	14*4	$^\circ C/W$

*1: With simultaneous operation of both two channels when mounted on glass-epoxy board 56.5mm x 56.5mm (copper foil area 50%).

*2: With operation of one channel when mounted on glass-epoxy board 56.5mm x 56.5mm (copper foil area 50%).

*3: Junction - to - pin 14 (CH1)

*4: Junction - to - pin 10 (CH2)

Recommended Operating Control

($T_a=25^\circ C$)

Parameter	Symbol	Ratings	Unit
DC Input Voltage Range	V_{IN}	5.5*1 to 8.0	V
Output Current Range	I_o	0 to +0.5	A
Ambient Operating Temperature	T_{aop}	-10 to +85	$^\circ C$
Junction Operating Temperature	T_{jop}	-10 to +100	$^\circ C$

*1: $V_{IN(min)}$ must be no less than the sum of output voltage and dropout voltage.

Electrical Characteristics

(T_a=25°C unless otherwise specified)

Parameter	Symbol	Ratings			Unit	
		min.	typ.	max.		
Output Voltage	V _o	4.85	5.00	5.15	V	
	Conditions	V _{IN} =7V, I _o =0.1A				
Dropout Voltage	V _{DIF}			0.5	V	
	Conditions	I _o ≤0.5A				
Line Regulation	ΔV _{OLINE}			30	mV	
	Conditions	V _{IN} =6 to 15V, I _o =0.1A				
Load Regulation	ΔV _{OLOAD}			50	mV	
	Conditions	V _{IN} =7V, I _o =0 to 0.5A				
Temperature Coefficient of Output Voltage	ΔV _o /ΔT _a		±0.5		mV/°C	
	Conditions	V _{IN} =7V, I _o =5mA, T _J =-10 to 100°C				
Quiescent Circuit Current	I _q			12* ¹	mA	
	Conditions	V _{IN} =7V, I _o =0A				
Quiescent Circuit Current (Output OFF)	I _{q (off)}			0.25 * ¹	mA	
	Conditions	V _{IN} =7V, V _{C1} and 2=0V				
Overcurrent Protection Starting Current* ¹	I _{s1}	0.75		0.96	A	
	Conditions	V _{IN} =7V				
V _C Terminal* ³	Control Voltage (Output ON)	V _{C, IH}	2.0		V	
	Control Voltage (Output OFF)	V _{C, IL}		0.7		
	Control Current (Output ON)	I _{C, IH}			50	μA
		Conditions	V _C =2.7V			
	Control Current (Output OFF)	I _{C, IL}			-100	μA
Conditions		V _C =0V				
OCP Detection	V _{oth}	3.7	4.0	4.3	V	
Delay Threshold Voltage	V _{DLYth}	2.1	2.3	2.5	V	
Delay Terminal Output Current	I _{DLY}	35	50	65	μA	
Flag Output Terminal	Before OCP Detection	V _{FLGh}	V _{IN} -0.4		V	
		Conditions	R _{FLG} connected between FLG and V _{IN}			
	After OCP Detection	V _{FLGi}			0.5	V
		Conditions	I _{FLG} =1mA			
FLG Reset Time * ⁴	t _{Reset}		1.2		μS	

*1: Total of two circuits

*2: I_{s1} is specified at -5 (%) drop point of output voltage V_o on the condition that V_{IN}=7V, I_o=0.1A.*3: Output is ON even when output control terminal V_C is open. Each input level is equivalent to LS-TTL. Therefore, it may be directly driven by an LS-TTL circuit.

*4: Refer to timing chart on p.103

External Dimensions

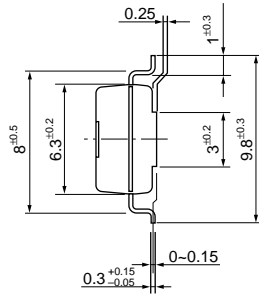
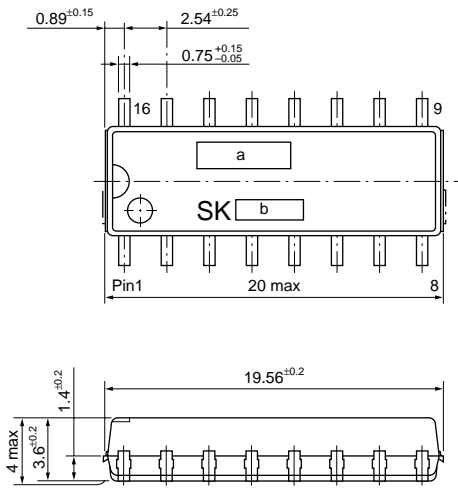

- a. Part Number
- b. Lot Number

Pin Arrangement

- | | |
|--------|--------|
| ① FLG1 | ⑨ GND2 |
| ② DLY1 | ⑩ GND2 |
| ③ Vo1 | ⑪ Vc2 |
| ④ VIN1 | ⑫ Vc2 |
| ⑤ FLG2 | ⑬ GND1 |
| ⑥ DLY2 | ⑭ GND1 |
| ⑦ Vo2 | ⑮ Vc1 |
| ⑧ VIN2 | ⑯ Vc1 |

Plastic Mold Package Type
 Flammability: UL94V-0
 Weight: Approx. 1.05g

Block Diagram

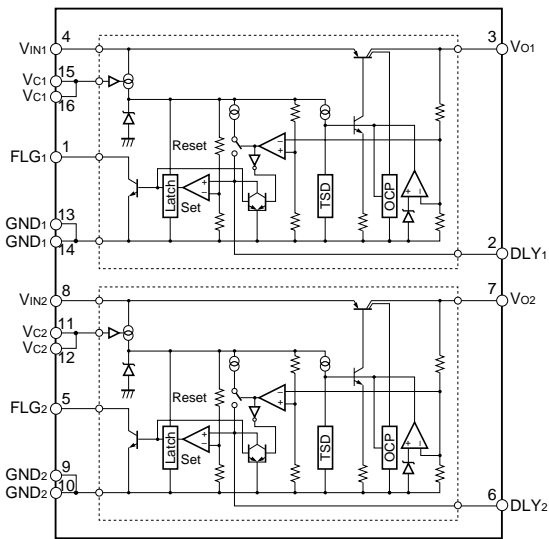

Standard External Circuit

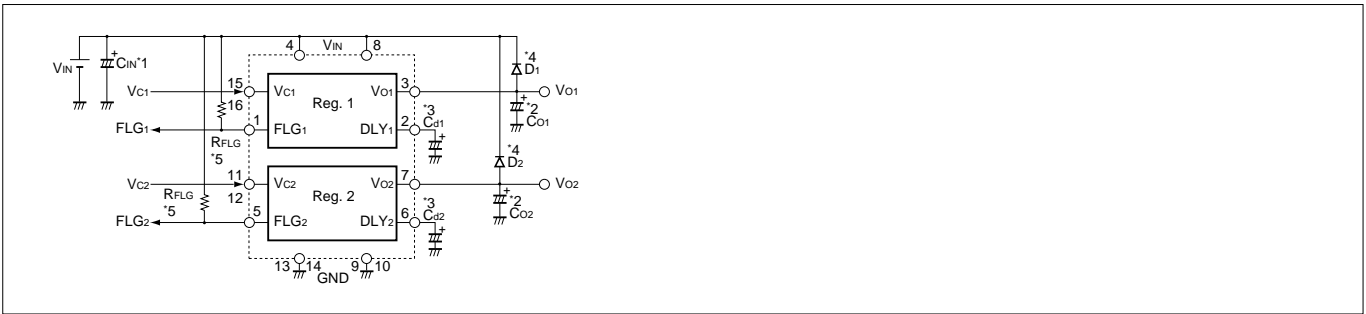

- *1 C_{IN} : Input capacitor (Approx. 47 μ F)
This capacitor is required if the input line is inductive and in the case of long wiring.
- *2 C_o : Output capacitor (47 to 220 μ F)
When used at low temperature (-10° or less), set to 100 μ F or more or use tantalum capacitor.
- *3 C_d : Delay time setting capacitor (0.1 μ F or more)
Use C_d to set the delay time (t_{DLY}) from when a low V_o level due to OCP operation is detected until a flag signal is output.
This prevents a rush current from causing malfunction at start.
Approximate calculation: $t_{DLY} \approx (C_d \times V_{DLYth}) / I_{DLY}$ [sec]
When using soft start on V_{IN} or if C_{IN} has a large capacitance, set t_{DLY} long enough for the output voltage to rise sufficiently.
Be sure to connect C_d and do not use it for other applications, such as short circuiting C_d .

Timing chart

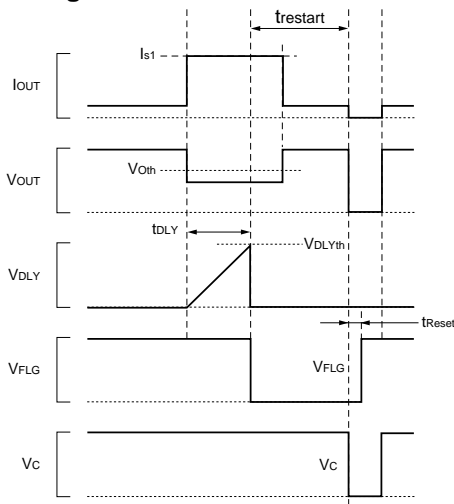

R_{FLG} connected between FLG and V_{IN}

FLG output operates after the time t_{DLY} has elapsed (the time set by DLY) after OCP is detected, and is latched. The latch can be reset by making V_c or V_{IN} low. Allow a time lag of $C_d \times 600$ [sec] or more between setting and restarting.

- *4 $D_{1,2}$: Reverse biasing protection diode.
This diode is required for protection against reverse biasing of the input and output.
- *5 R_{FLG} : Set this to limit the inflow current into the FLG terminal to 1mA or less.

T_a - P_d Characteristics

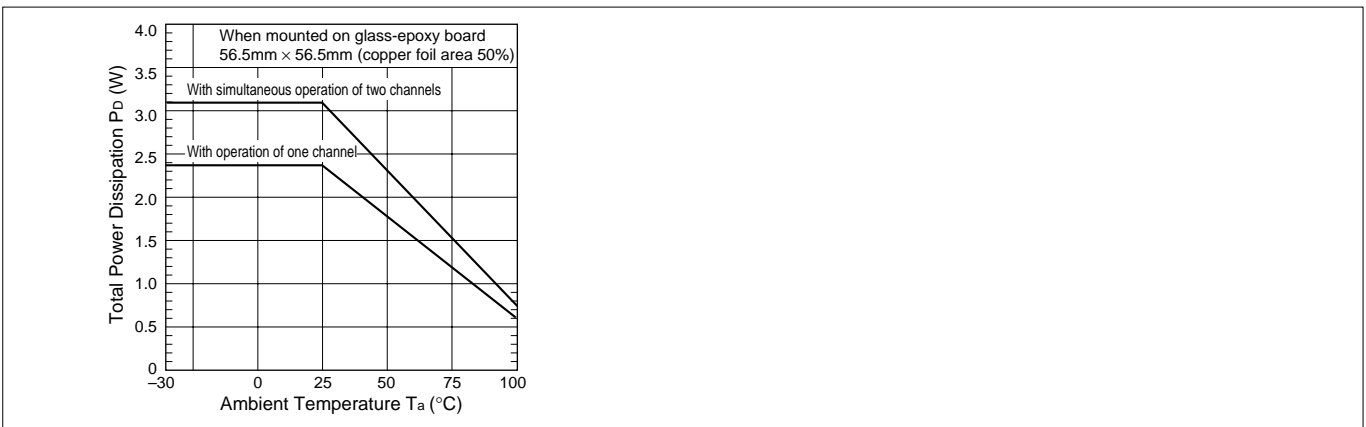

SLA3001M/3002M/3004M

3-Output Dropper/Switching Type

■Features

- 3 regulator ICs combined in 1 package
- Insulated single inline package
- Can be used with dropper type and switching type
- 3 independent circuits for input and output respectively. Internal dissipation can be reduced since different input voltages can be applied.
- Dropper type regulator IC is low-dropout voltage type with input/output voltage difference of 1V. Output ON/OFF control, variable output voltage (rise only) function
- Switching type: built-in separate excitation (60kHz), high efficiency of 80% or over
- Each regulator has overcurrent protection and thermal protection circuit.

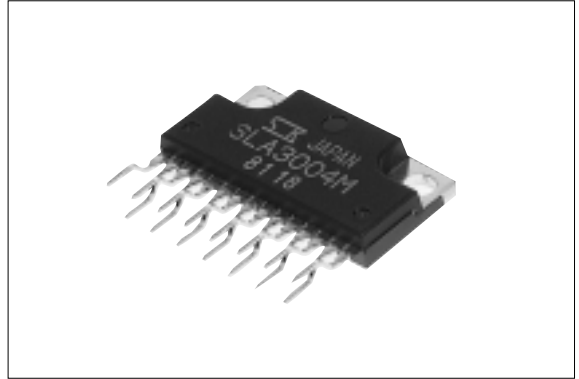

■Applications

- For stabilization of the secondary stage of switching power supplies
- Electronic equipment

■Lineup

Part Number	SLA3001M			SLA3002M			SLA3004M		
	Type	Vo(V)	Io(A)	Type	Vo (V)	Io(A)	Type	Vo (V)	Io (A)
Regulator 1	Dropper	12	1.5	Switching	5	0.5	Switching	5	0.5
Regulator 2	Dropper	5	1.5	Dropper	15.7	1.0	Switching	9	0.4
Regulator 3	Dropper	9	1.5	Switching	9	0.4	Switching	9	0.4

■Absolute Maximum Ratings

Parameter	Symbol	Ratings									Unit
		SLA3001M			SLA3002M			SLA3004M			
		Reg1	Reg2	Reg3	Reg1	Reg2	Reg3	Reg1	Reg2	Reg3	
DC Input Voltage	V _{IN}	35			35			35			V
Voltage of Output Control Terminal	V _C	V _{IN}			—	V _{IN}	—	—			V
SW Terminal Applied Reverse Voltage	V _{SW}	—			-1	—	-1	-1			V
Power Dissipation	P _D	40(T _C =25°C)			37.5(T _C =25°C)			37.5(T _C =25°C)			W
Junction Temperature	T _J	+125			+150			+150			°C
Storage Temperature	T _{stg}	-40 to +125			-40 to +150			-40 to +150			°C
Ambient Operating Temperature	T _{op}	-30 to +85			-30 to +85			-30 to +85			°C
Thermal Resistance(junction-to-case)	R _{th(j-c)}	7			10			10			°C/W

Electrical Characteristics

(Ta=25°C unless otherwise specified)

	Parameter	Symbol	Ratings									Unit
			SLA3001M			SLA3002M			SLA3004M			
			min.	typ.	max.	min.	typ.	max.	min.	typ.	max.	
Regulator 1	Recommended DC Input Voltage	V _{IN1}	13		25	7		33	7		33	V
	Output Voltage	V _{O1}	11.52	12.00	12.48	4.75	5.00	5.25	4.75	5.00	5.25	V
		Conditions	V _{IN} =15V, I _O =1.0A			V _{IN} =20V, I _O =0.3A			V _{IN} =20V, I _O =0.3A			
	Dropout Voltage	V _{DI1}			1.0	—————			—————			V
		Conditions	I _O =1.5A			—————			—————			
	Efficiency	η ₁	—————			80			80			%
		Conditions	—————			V _{IN} =20V, I _O =0.3A			V _{IN} =20V, I _O =0.3A			
	Line Regulation	ΔV _{OLINE1}		24	64		80	100		80	110	mV
		Conditions	V _{IN} =13 to 25V, I _O =1.0A			V _{IN} =10 to 30V, I _O =0.3A			V _{IN} =10 to 30V, I _O =0.3A			
	Load Regulation	ΔV _{OLOAD1}		93	240		30	40		30	40	mV
Conditions		V _{IN} =15V, I _O =0 to 1.5A			V _{IN} =20V, I _O =0.1 to 0.4A			V _{IN} =20V, I _O =0.1 to 0.4A				
Switching Frequency	f ₁	—————			60			60			kHz	
	Conditions	—————			V _{IN} =20V, I _O =0.3A			V _{IN} =20V, I _O =0.3A				
Overcurrent Protection Starting Current* ¹	I _{S1, 1}	1.6			0.55			0.55			A	
	Conditions	V _{IN} =15V			V _{IN} =10V			V _{IN} =10V				
V _C Terminal* ²	Control Voltage (Output ON)	V _{CIH, 1}	2.0			—————			—————			V
	Control Voltage (Output OFF)	V _{CIL, 1}			0.8	—————			—————			V
Regulator 2	Recommended DC Input Voltage	V _{IN2}	6		15	17		30	12		33	V
	Output Voltage	V _{O2}	4.85	5.00	5.15	14.92	15.70	16.48	8.55	9.00	9.45	V
		Conditions	V _{IN} =8V, I _O =1.0A			V _{IN} =19V, I _O =0.5A			V _{IN} =21V, I _O =0.3A			
	Dropout Voltage	V _{DI2}			1.0			1.0	—————			V
		Conditions	I _O =1.5A			I _O =1.0A			—————			
	Efficiency	η ₂	—————			—————			85			%
		Conditions	—————			—————			V _{IN} =21V, I _O =0.3A			
	Line Regulation	ΔV _{OLINE2}		10	30		30	90		90	110	mV
		Conditions	V _{IN} =6 to 15V, I _O =1.0A			V _{IN} =17 to 25V, I _O =0.5A			V _{IN} =14 to 30V, I _O =0.3A			
	Load Regulation	ΔV _{OLOAD2}		40	100		120	300		50	80	mV
Conditions		V _{IN} =8V, I _O =0 to 1.5A			V _{IN} =19V, I _O =0 to 0.1A			V _{IN} =21V, I _O =0.1 to 0.4A				
Switching Frequency	f ₂	—————			—————			60			kHz	
	Conditions	—————			—————			V _{IN} =21V, I _O =0.3A				
Overcurrent Protection Starting Current* ¹	I _{S1, 2}	1.6			1.2			0.45			A	
	Conditions	V _{IN} =8V			V _{IN} =19V			V _{IN} =14V				
V _C Terminal* ²	Control Voltage (Output ON)	V _{CIH, 2}	2.0			2.0			—————			V
	Control Voltage (Output OFF)	V _{CIL, 2}			0.8			0.8	—————			V
Regulator 3	Recommended DC Input Voltage	V _{IN3}	10		20	12		33	12		33	V
	Output Voltage	V _{O3}	8.64	9.00	9.36	8.55	9.00	9.45	8.64	9.00	9.36	V
		Conditions	V _{IN} =12V, I _O =1.0A			V _{IN} =21V, I _O =0.3A			V _{IN} =21V, I _O =0.3A			
	Dropout Voltage	V _{DI3}			1.0	—————			—————			V
		Conditions	I _O =1.5A			—————			—————			
	Efficiency	η ₃	—————			85			85			%
		Conditions	—————			V _{IN} =21V, I _O =0.3A			V _{IN} =21V, I _O =0.3A			
	Line Regulation	ΔV _{OLINE3}		18	48		90	110		90	110	mV
		Conditions	V _{IN} =10 to 20V, I _O =1.0A			V _{IN} =14 to 30V, I _O =0.3A			V _{IN} =14 to 30V, I _O =0.3A			
	Load Regulation	ΔV _{OLOAD3}		70	180		50	80		50	80	mV
Conditions		V _{IN} =15V, I _O =0 to 1.5A			V _{IN} =21V, I _O =0.1 to 0.4A			V _{IN} =21V, I _O =0.1 to 0.4A				
Switching Frequency	f ₃	—————			60			60			kHz	
	Conditions	—————			V _{IN} =21V, I _O =0.3A			V _{IN} =21V, I _O =0.3A				
Overcurrent Protection Starting Current* ¹	I _{S1, 3}	1.6			0.45			0.45			A	
	Conditions	V _{IN} =12V			V _{IN} =14V			V _{IN} =14V				
V _C Terminal* ²	Control Voltage (Output ON)	V _{CIH, 3}	2.0			—————			—————			V
	Control Voltage (Output OFF)	V _{CIL, 3}			0.8	—————			—————			V

*1: I_{S1} of Dropper Type is specified at -5(%) drop point of output voltage V_O. I_{S1} of Switching Type is specified at -10(%) drop point of output voltage V_O.

*2: Output is ON when V_C terminal is open.

■External Dimensions

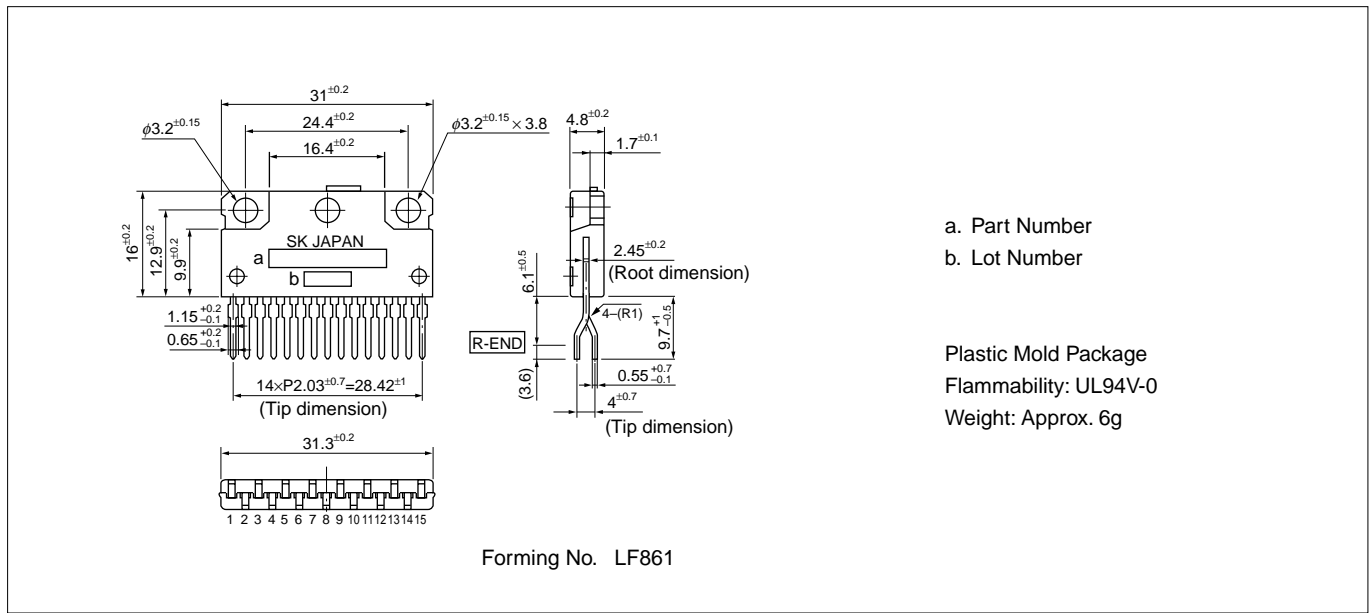

■Block Diagram

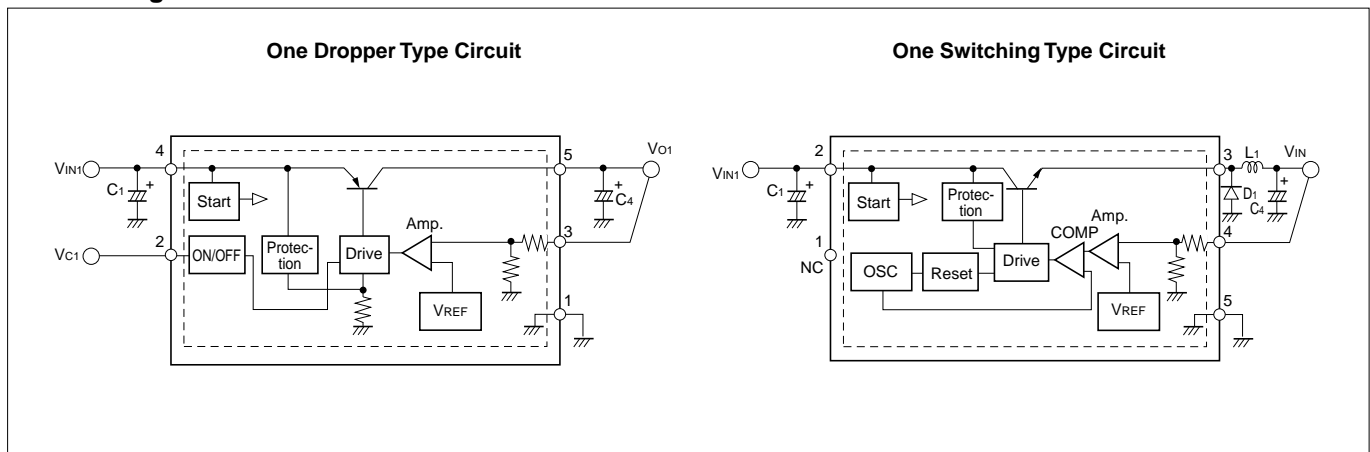

■Standard External Circuit

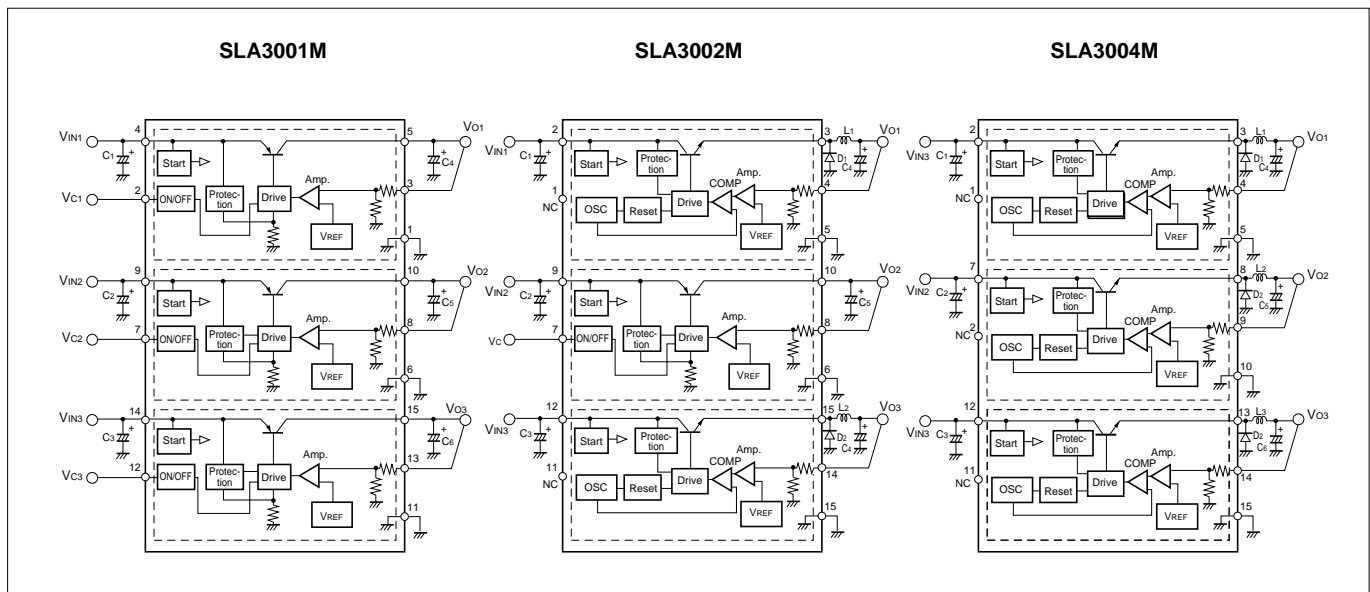

■Selecting External components for dropper type regulator

Input capacitor (Approx. 47 μ F)

Output capacitor (Approx. 47 to 100 μ F)

- Low ESR capacitors are recommended for input and output when using them in low temperature conditions (0°C or less)

■Selecting External components for switching type regulator

Input capacitor (Approx. 100 μ F)

Output smoothing capacitor (Approx. 330 μ F)

- Input capacitor and output capacitor must satisfy allowable ripple current.
- Low ESR capacitors are recommended for reducing output ripple voltage.
- Low ESR capacitors are recommended for input and output when using them in low temperature conditions (0°C or less)

Choke coil (200 μ H when V_o is 3.3V or 5V, 300 μ H when V_o is other)

- When its winding resistance is high, its efficiency may decrease and the rated value may not be achieved.
- Pay attention to heat from the choke coil due to magnetic saturation caused by overload, short circuit of load, etc. because the overcurrent protection starting current is approx. 1A.

Flywheel diode (Sanken AK04 recommended)

- Use a Schottky barrier diode for D₁, D₂ and D₃ and make sure that the reverse voltage applied to SW output terminal does not exceed the value (–1V) given in the maximum ratings.
- If you use a fast recovery diode or any other diode, application of a reverse voltage generated from the recovery or ON voltage of the diode may damage the IC.

Typical Characteristics

($T_a=25^\circ\text{C}$)

SLA3001M (Regulator 2, $V_o=5\text{V}$)

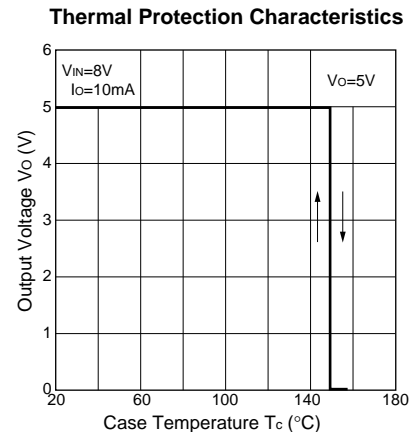
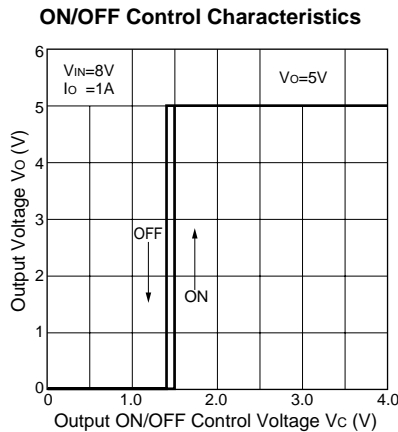
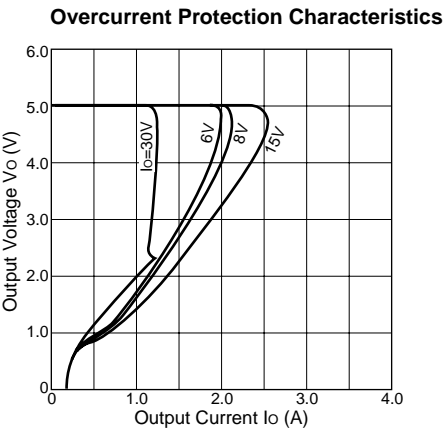
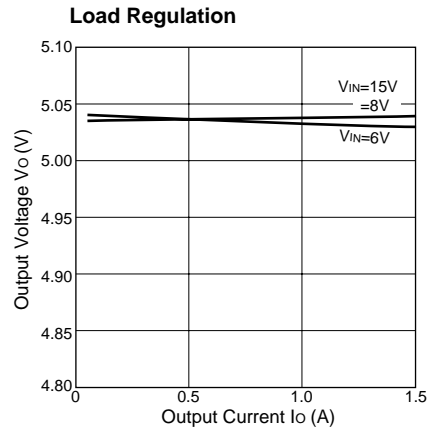
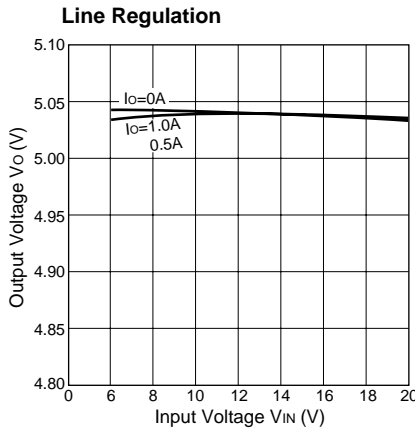
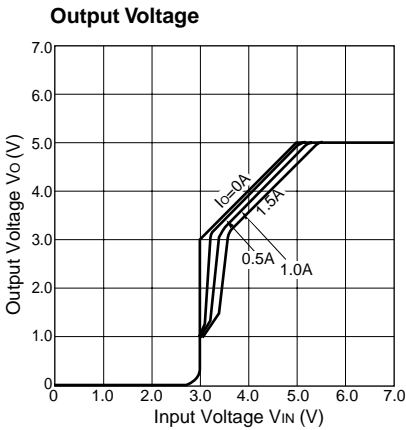

Note on Thermal Protection:
The thermal protection circuit is intended for protection against heat during instantaneous short-circuiting. Its operation is not guaranteed for continuous heating condition such as short-circuiting over extended periods of time.

SLA3002M/SLA3004M(Regulator 1, $V_o=5\text{V}$)

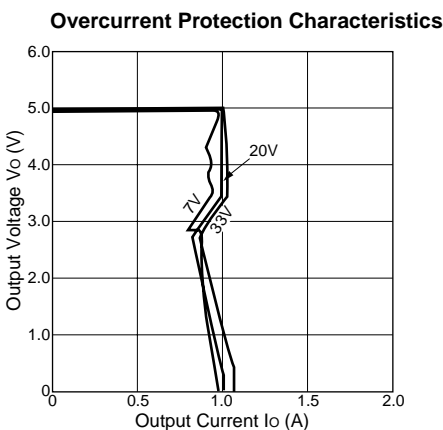
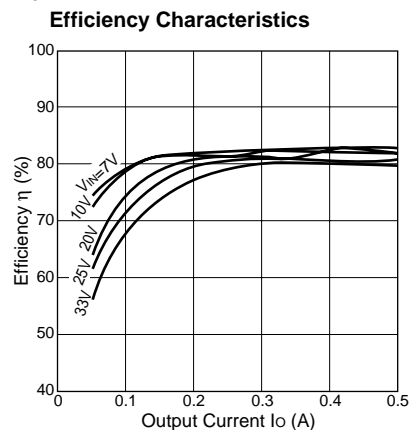
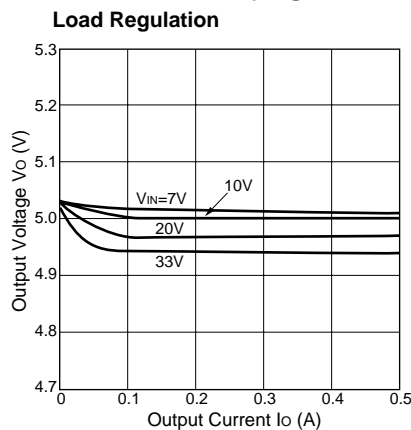
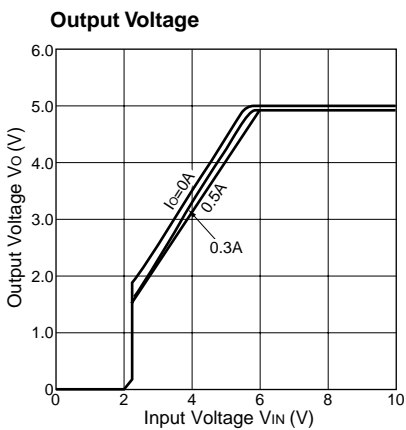

SLA3005M/3006M/3007M

4-Output, Low Dropout Voltage Dropper Type for USB Hub

■Features

- 4 regulators combined in one package
- Insulated single inline package
- SLA 3005M/3006M have four 5V/0.5A outputs. SLA3007M has three 5V/0.5A outputs and ch4 is a 3.3V/0.5A output for USB-IC
- Low dropout voltage: $V_{DIF} \leq 0.5V$ (at $I_o = 0.5A$)
- Output-independent ON/OFF control terminal compatible with LS-TTL (Active High)
- Output-independent overcurrent and thermal protection circuits built in
- Open collector flag-output terminals built in to output OCP operation to each output terminal (Active Low) excluding SLA3007Mch4
- SLA3005M/3007M (excluding ch4) for V_o shutdown after OCP operation and SLA3006M for continuous OCP operation
- Built-in anti-malfunction delay circuit whose time can be set with an external capacitor

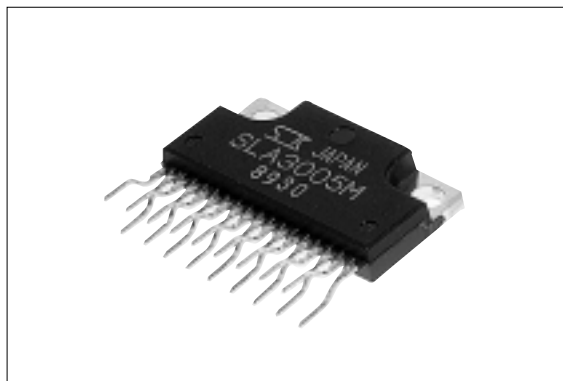

■Applications

- USB hub power supplies
- Electronic equipment

■Absolute Maximum Ratings

($T_a = 25^\circ C$)

Parameter	Symbol	Ratings		Unit
		SLA3005M/3006M	SLA3007M	
DC Input Voltage	V_{IN}	20	18	V
Voltage of Output Control Terminal	V_C	V_{IN}		V
DC Output Current	I_o	0.5		A
Power Dissipation	P_{D1}	30(With infinite heatsink)		W
	P_{D2}	3.36(Without heatsink, stand-alone operation)		W
Junction Temperature	T_j	-30 to +125		$^\circ C$
Ambient Operating Temperature	T_{OP}	-30 to +100		$^\circ C$
Storage Temperature	T_{stg}	-30 to +125		$^\circ C$
Thermal Resistance (junction-to-case)	$R_{t(j-c)}$	9.0		$^\circ C/W$
Thermal Resistance (junction-to-ambient air)	$R_{th(j-a)}$	29.8(Without heatsink, stand-alone operation)		$^\circ C/W$

■Recommended Operating Conditions

Parameter	Symbol	Ratings	Unit
DC Input Voltage Range	V_{IN}	5.5 to 10	V
Output Current Range	I_o	0 to 0.5	A
Operating Junction Temperature Range	T_{jop}	-20 to +100	$^\circ C$
Ambient Operating Temperature Range	T_{aop}	-20 to +85	$^\circ C$

■Electrical Characteristics

(Ta=25°C unless otherwise specified)

Parameter	SYMBOL	Ratings											Unit		
		SLA3005M			SLA3006M			SLA3007M							
		min.	typ.	max.	min.	typ.	max.	ch1, 2, 3			ch4				
							min.	typ.	max.	min.	typ.	max.			
Output Voltage	Vo	4.85	5.00	5.15	4.85	5.00	5.15	4.85	5.00	5.15	3.234	3.300	3.366	V	
	Conditions	VIN=7V, Io=0.1A			VIN=7V, Io=0.1A			VIN=7V, Io=0.1A			VIN=7V, Io=0.1A				
Dropout Voltage	V _{DIF}			0.5			0.5			0.5			2.0	V	
	Conditions	Io≤0.5A			Io≤0.5A			Io≤0.5A			Io≤0.5A				
Line Regulation	ΔV _{OLINE}			30			30			30			30	mV	
	Conditions	VIN=6 to 15V, Io=0.1A			VIN=6 to 15V, Io=0.1A			VIN=6 to 15V, Io=0.1A			VIN=6 to 15V, Io=0.1A				
Load Regulation	ΔV _{OLOAD}			50			50			50			30	mV	
	Conditions	VIN=7V, Io=0 to 0.5A			VIN=7V, Io=0 to 0.5A			VIN=7V, Io=0 to 0.5A			VIN=7V, Io=0 to 0.2A				
Temperature Coefficient of Output Voltage	ΔVo/ΔTa		±0.5			±0.5			±0.5			±0.3		mV/°C	
	Conditions	VIN=7V, Io=5mA, Tj=-10 to 100°C			VIN=7V, Io=5mA, Tj=-10 to 100°C			VIN=7V, Io=5mA, Tj=-10 to 100°C			VIN=7V, Io=5mA, Tj=-10 to 100°C				
Quiescent Circuit Current*3	Iq			20			20			20	-			mA	
	Conditions	VIN=7V, Io=0A			VIN=7V, Io=0A			VIN=7V, Io=0A							
Quiescent Circuit Current (Output OFF)*3	Iq(off)			0.5			0.5			0.5	-			mA	
	Conditions	VIN=7V, Vc1 to 4=0V			VIN=7V, Vc1 to 4=0V			VIN=7V, Vc1 to 4=0V							
Overcurrent Protection Starting Current*1	Is1	0.55		0.65	0.75		0.96	0.55		0.65	0.55		0.65	A	
	Conditions	VIN=7V			VIN=7V			VIN=7V			VIN=7V				
Vc Terminal ²	Control Voltage (Output ON)	Vc IH	2.0		2.0			2.0			2.0			V	
	Control Voltage (Output OFF)	Vc IL			0.7					0.7			0.7		
	Control Current (Output ON)	Ic IH			50			50			50			50	μA
		Conditions	Vc=2.7V			Vc=2.7V			Vc=2.7V			Vc=2.7V			
	Control Current (Output OFF)	Ic IL			-100			-100			-100			-100	μA
		Conditions	Vc=0V			Vc=0V			Vc=0V			Vc=0V			
OCP Detection Voltage Level	V _{oth}	3.7	4.0	4.3	3.7	4.0	4.3	3.7	4.0	4.3	-			V	
Delay Threshold Voltage	V _{DLYth}	2.1	2.3	2.5	2.1	2.3	2.5	2.1	2.3	2.5	-			V	
Delay Terminal Output Current	IDLY	35	50	65	35	50	65	35	50	65	-			μA	
Flag Output Terminal	Before OCP Detection	V _{FLGh}	VIN-0.4			VIN-0.4			VIN-0.4			-			V
		Conditions	R _{FLG} connected between FLG and VIN			R _{FLG} connected between FLG and VIN			R _{FLG} connected between FLG and VIN						
	After OCP Detection	V _{FLGi}			0.5			0.5			0.5	-			V
		Conditions	IFLG=1mA			IFLG=1mA			IFLG=1mA						

*1 Is1 is specified at -5(%) drop point of output voltage Vo on the condition that VIN = 7V, Io = 0.1A.

*2 Output is ON even when output control terminal Vc is open. Each input level is equivalent to LS-TTL. Therefore, it may be directly driven by an LS-TTL circuit.

*3 Total of four circuits

* The FLG output latched by delay DLY after OCP detection. (SLA3005M/SLA3007M (ch1 to 3) shuts down the output voltage simultaneously at latching.) Set the VIN or Vc to low to reset latching. Leave a time lag of Cd × 600s or more before restart.

** SLA3007Mch4 does not have the FLG output function.

External Dimensions

(unit:mm)

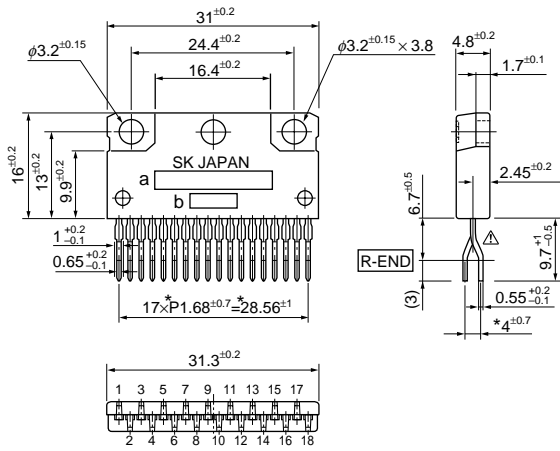

- a. Part Number
- b. Lot Number

Pin Arrangement

- | | |
|--------|-----------------------|
| ① Vc1 | ⑩ FLG3 |
| ② FLG1 | ⑪ DLY3 |
| ③ DLY1 | ⑫ Vo3 |
| ④ Vo1 | ⑬ GND |
| ⑤ Vc2 | ⑭ Vc4 |
| ⑥ FLG2 | ⑮ FLG4 (SLA3007M: NC) |
| ⑦ DLY2 | ⑯ DLY4 (SLA3007M: NC) |
| ⑧ Vo2 | ⑰ Vo4 |
| ⑨ Vc3 | ⑱ VIN |

Plastic Mold Package Type
 Flammability: UL94V-0
 Weight: Approx. 6g

Block Diagram

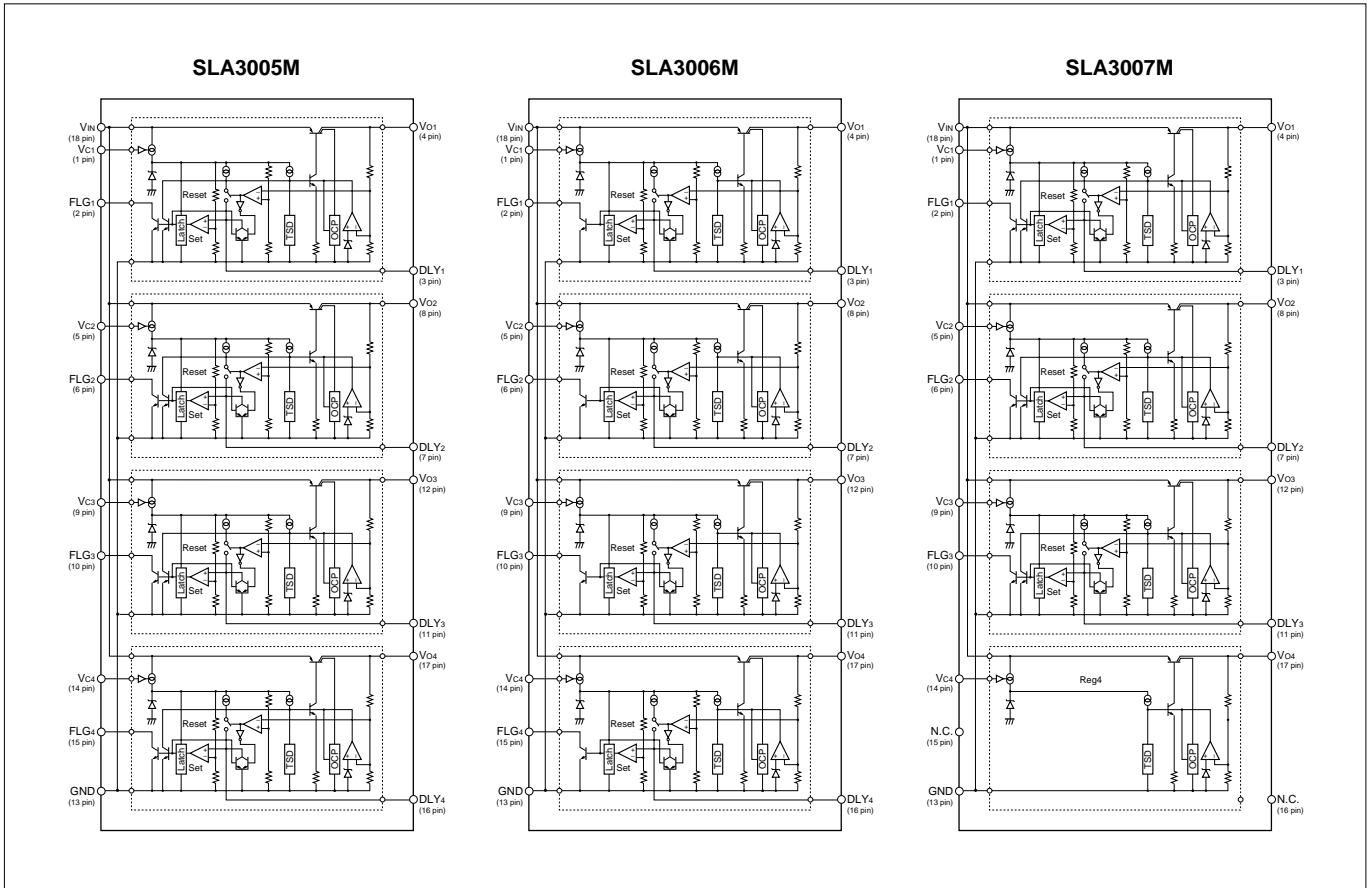

■Standard External Circuit

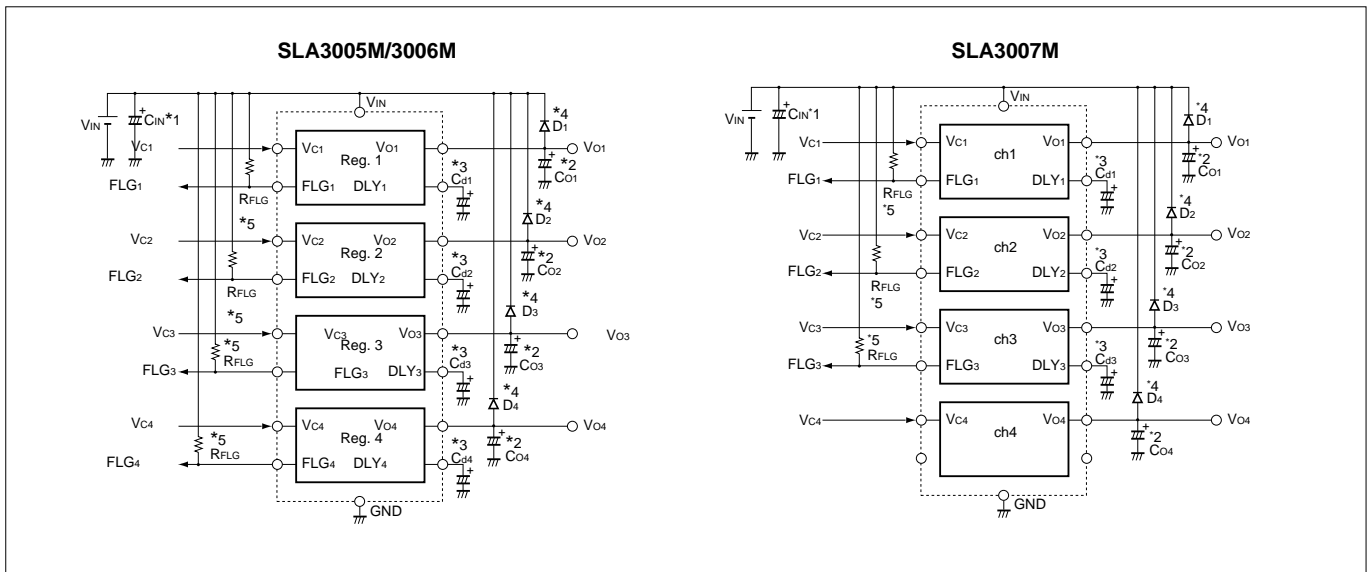

- *1 C_{IN} : Input capacitor (Approx. 47μF)
This capacitor is required if the input line is inductive and in the case of long wiring.
- *2 C_O : Output capacitor (47 to 220μF)
- *3 C_d : Delay time setting capacitor (0.1μF or more)
Use C_d to set the delay time (t_{DLY}) from when a low V_O level due to OCP operation is detected until a flag signal is output. This prevents a rush current from causing malfunction at start.
Approximate calculation: $t_{DLY} \approx (C_d \times V_{DLYth}) / I_{DLY} [\text{sec}]$
When using soft start on V_{IN} or if C_{IN} has a large capacitance, set t_{DLY} long enough for the output voltage to rise sufficiently. Be sure to connect C_d and do not use it for other applications, such as short circuiting C_d.
- *4 D₁ to D₄ : Reverse biasing protection diode
This diode is required for protection against reverse biasing of the input and output.
- *5 R_{FLG} : Set this to limit the inflow current into the FLG terminal to 1mA or less.

■T_a-P_d Characteristics

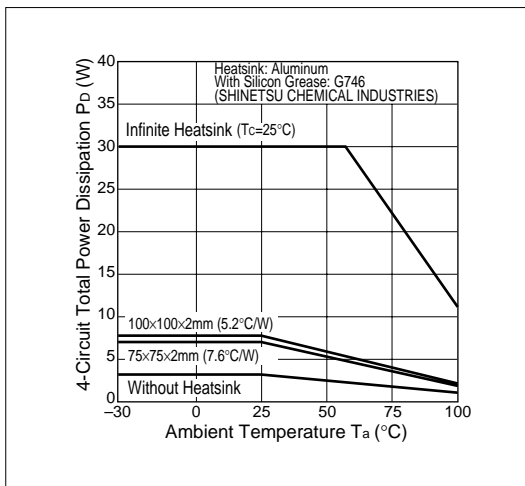

■Timing Chart

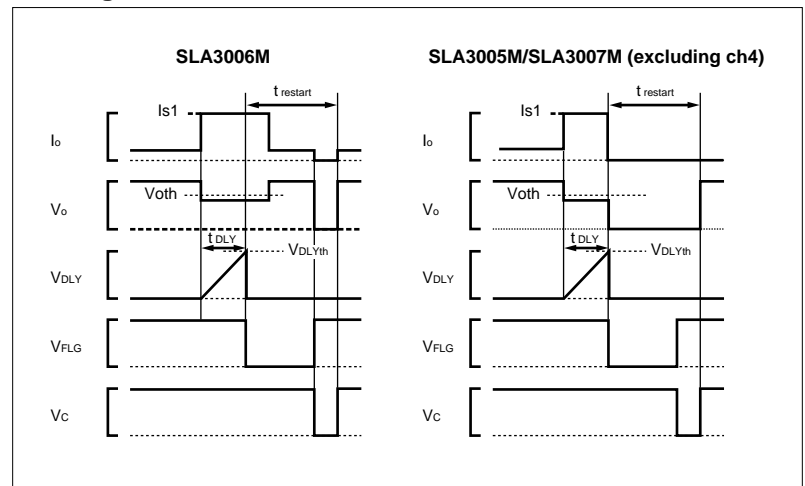

■Calculating the Internal Dissipation

P_D is calculated as follows:

$$P_D = [I_{O1} \cdot (V_{IN} - V_{O1})] + [I_{O2} \cdot (V_{IN} - V_{O2})] + [I_{O3} \cdot (V_{IN} - V_{O3})] + [I_{O4} \cdot (V_{IN} - V_{O4})] + V_{IN} \cdot I_G$$

■Estimating T_j by Temperature Measurement

1. Measuring position: At the root of pin 13
2. Add the thermal resistance "θ_{j-L}" between the junction and pin 13 and the P_d product of each channel to the measured temperature.
θ_{j-L} is as follows : θ_{j-L1}:8°C/W, θ_{j-L2}:7°C/W, θ_{j-L3}:5°C/W, θ_{j-L4}:8°C/W
The calculation formula is as follows : T_j=θ_{j-L1}•P_{d1}+θ_{j-L2}•P_{d2}+θ_{j-L3}•P_{d3}+θ_{j-L4}•P_{d4}+T_{13pin}

Typical Characteristics SLA3005M

($T_a=25^\circ\text{C}$)

I_o vs. V_{DIF} Characteristics

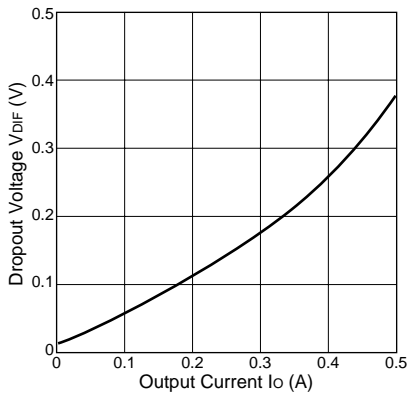

Output Voltage

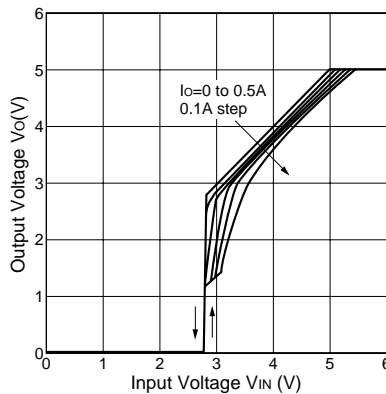

Quiescent Circuit Current

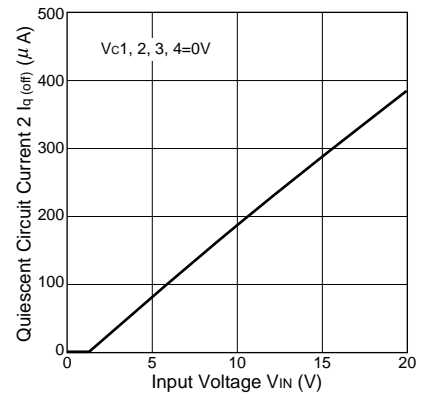

Circuit Current 1-Circuit

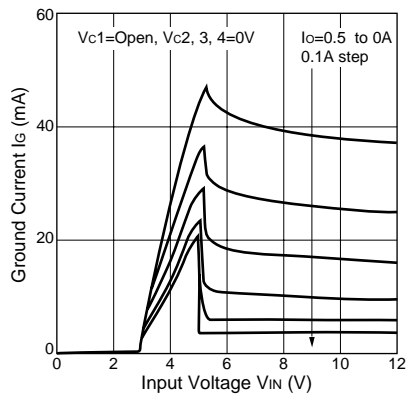

Circuit Current 4-Circuits

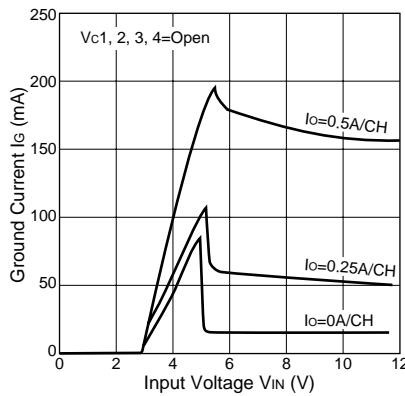

Overcurrent Protection Characteristics

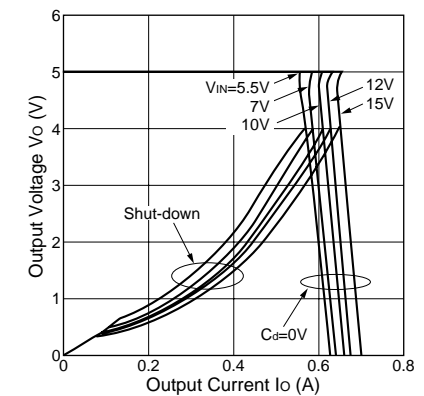

V_{IN} vs. I_{s1} Characteristics

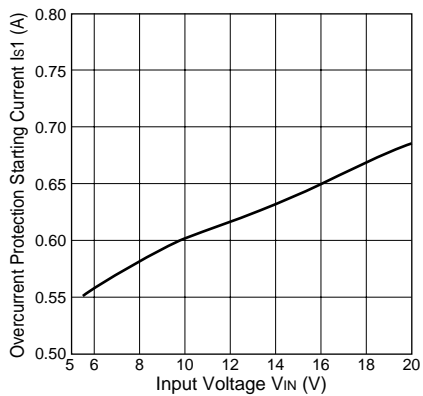

Line Regulation

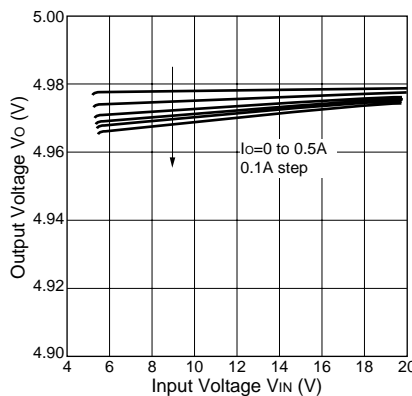

Load Regulation

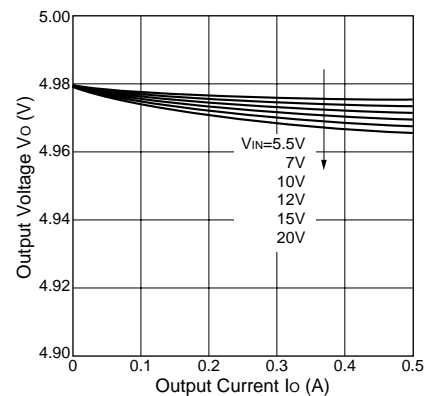

ON/OFF Control Characteristics

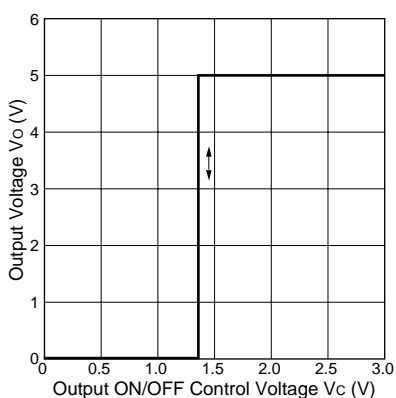

V_c Terminal Characteristics

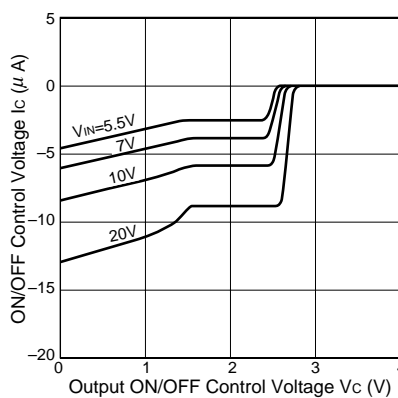

Thermal Protection Characteristics

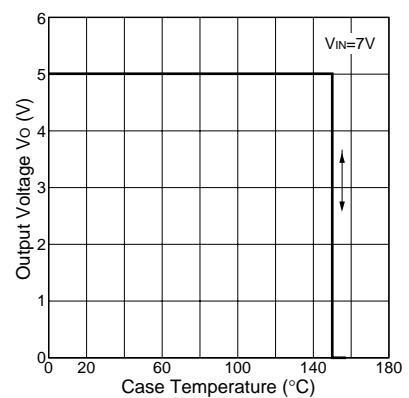

Typical Characteristics SLA3007M

($T_a=25^\circ\text{C}$)

Io vs. VDIF Characteristics

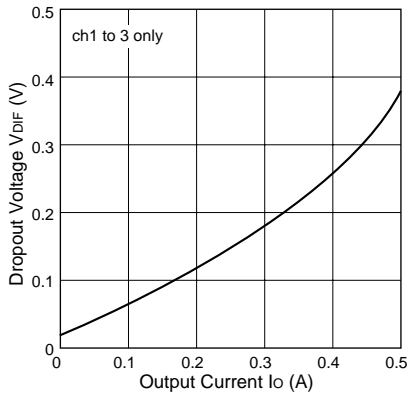

Output Voltage

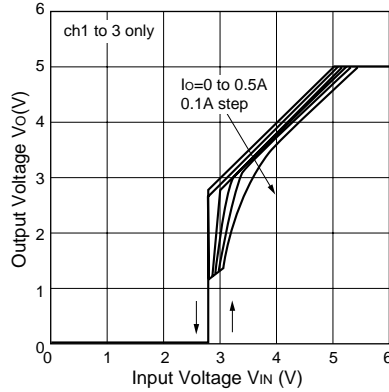

Output Voltage

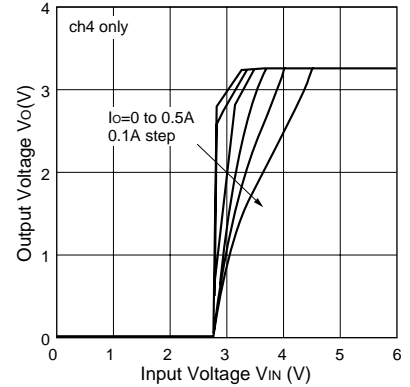

Quiescent Circuit Current

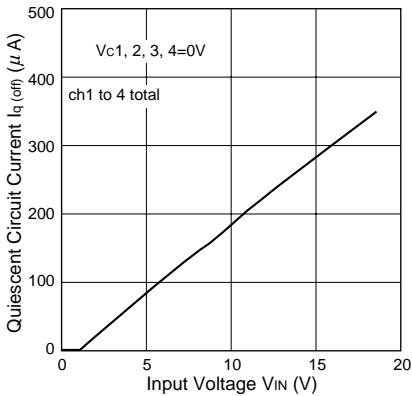

Circuit Current 1-Circuit (ch1 to 3)

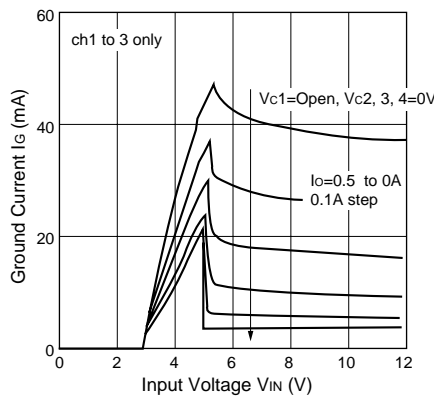

Circuit Current (ch4)

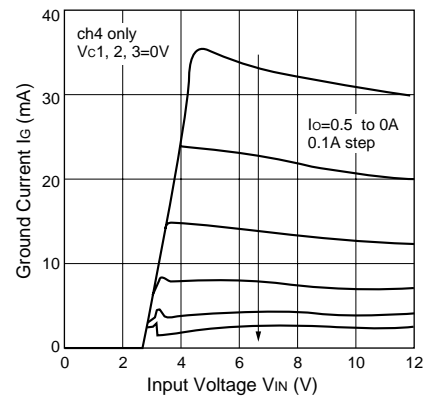

Overcurrent Protection Characteristics

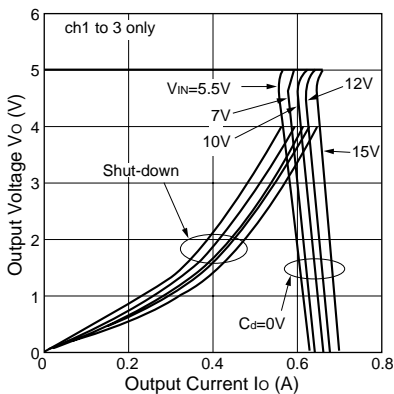

Overcurrent Protection Characteristics

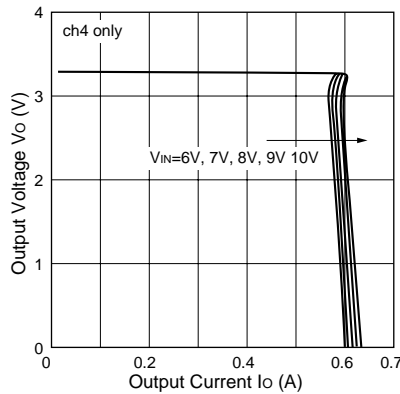

VIN vs. Is1 Characteristics

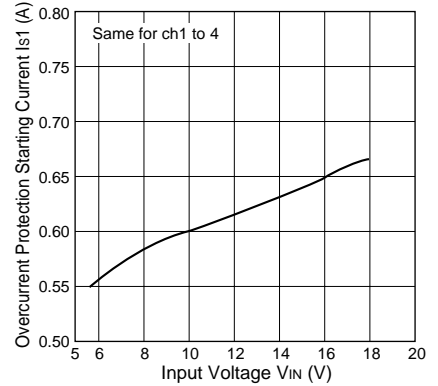

Line Regulation

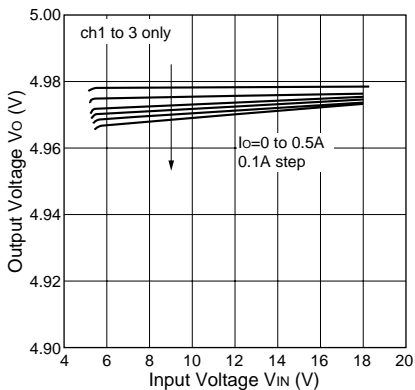

Load Regulation

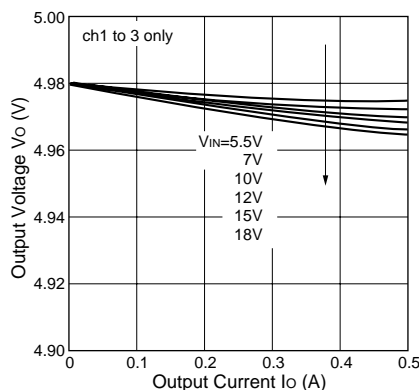

Line Regulation

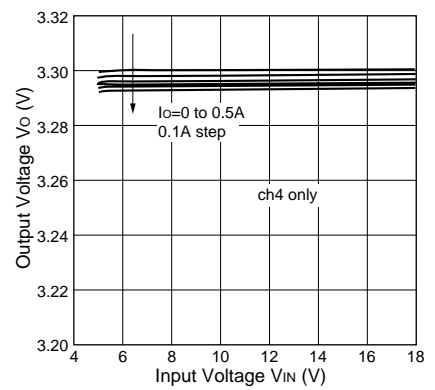

■Typical Characteristics SLA3007M

($T_a=25^\circ\text{C}$)

Load Regulation

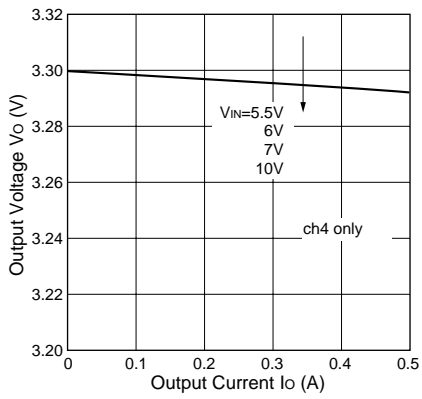

ON/OFF Control Characteristics

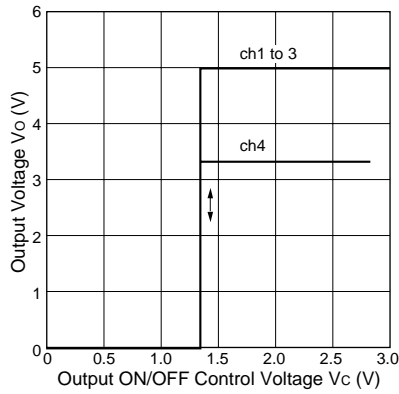

Vc Terminal Characteristics

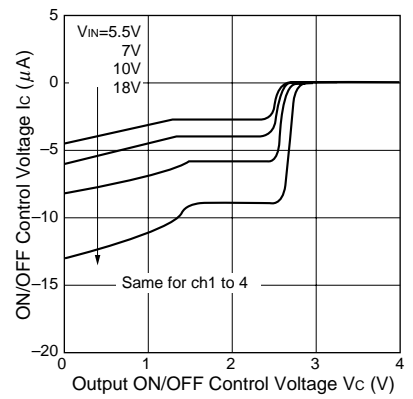

Thermal Protection Characteristics

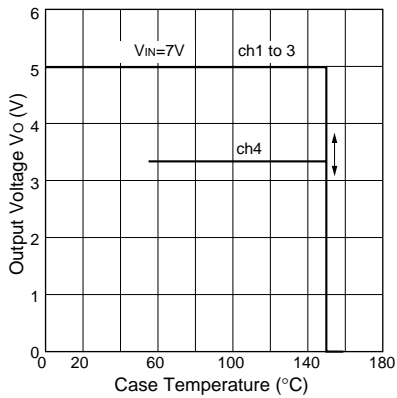



Sanken Electric Co.,Ltd.
1-11-1 Nishi -Ikebukuro,Toshima-ku, Tokyo
PHONE: 03-3986-6164
FAX: 03-3986-8637
TELEX: 0272-2323(SANKEN J)

Overseas Sales Offices
Asia

Sanken Electric Singapore Pte.Ltd.
150 Beach Road,#14-03 The Gateway West,
Singapore 0718
PHONE: 291-4755
FAX: 297-1744

Sanken Electric Hong Kong Co.,Ltd.
1018 Ocean Centre, Canton Road,
Kowloon, Hong Kong
PHONE: 2735-5262
FAX: 2735-5494
TELEX: 45498 (SANKEN HX)

Sanken Electric Korea Co.,Ltd.
SK Life B/D 6F,
168 Kongduk-dong, Mapo-ku, Seoul, 121-705, Korea
PHONE: 82-2-714-3700
FAX: 82-2-3272-2145

North America

Allegro MicroSystems,Inc.
115 Northeast Cutoff, Box 15036
Worcester, Massachusetts 01615, U.S.A.
PHONE: (508)853-5000
FAX: (508)853-7861

Europe

Allegro MicroSystems Europe Limited.
Balfour House, Churchfield Road,
Walton-on-Thames, Surrey KT12 2TD, U.K.
PHONE: 01932-253355
FAX: 01932-246622