

High Voltage Full Bridge Drive IC SLA2403M

Features

- One Package Full Bridge Driver Consisted of High Voltage IC and Power MOS FETs (4 pieces)
- High Voltage Driver which accepts direct connection to the input signal line
- External components such as high voltage diodes and capacitors are not required

Absolute Maximum Ratings

Parameter	Symbol	Ratings	Unit	Conditions
Power source voltage *	V_M	500	V	
Input voltage	V_{IN}	15	V	
Output voltage	V_O	500	V	
Output current	I_O	7	A	$T_C=25^\circ\text{C}$
	I_O (peak)	15	A	$P_W \leq 250\mu\text{s}$
Power dissipation	P_D	5 ($T_a=25^\circ\text{C}$)	W	Without heatsink
		40 ($T_C=25^\circ\text{C}$)	W	With infinite heatsink
Storage temperature	T_{stg}	-40 to +125	$^\circ\text{C}$	
Operation temperature	T_{opr}	-40 to +125	$^\circ\text{C}$	
Junction temperature	T_J	150	$^\circ\text{C}$	

* Power GND (D terminal) to -HV (-HV terminal) voltage.

Electrical Characteristics

Parameter	Symbol	Ratings			Unit	Conditions
		min	typ	max		
Power MOS FET output breakdown voltage	BV_{OUT}	500			V	$I_O=100\mu\text{A}$
Power MOS FET output leakage voltage	$I_{OUT}(\text{off})$			100	μA	$V_O=500\text{V}$
High-side Power MOS FET output on-state voltage	$V_{OUT(\text{on})}$	0.18	0.26	0.34	V	$I_O=0.4\text{A}, V_{IN}=10\text{V}$
Lowside Power MOS FET output on-state voltage	$V_{OUT(\text{on})}$	0.18	0.26	0.34	V	$I_O=0.4\text{A}, V_{GL}=10\text{V}$
Quiescent circuit current	I_{CC1}			3.0	mA	$V_{CC}=6$ to 15V
	I_{CC2}			4.0	mA	$V_{CC}=10\text{V}, V_M=400\text{V}$
Operating circuit current	I_{CC3}			4.0	mA	$V_{CC}=10\text{V}, V_M=400\text{V}$
Input voltage (High level)	V_{IH}	$0.8V_{CC}$			V	$V_{CC}=6$ to 15V
Input voltage (Low level)	V_{IL}			$0.2V_{CC}$	V	$V_{CC}=6$ to 15V
Delay time *	$t_d(\text{on})$		2.0		μs	$V_{CC}=10\text{A}, V_{IN}=10\text{V}, V_M=85\text{V}, I_O=0.41\text{A}$
	$t_d(\text{off})$		3.0		μs	
Operating voltage	V_{CC}	6		15	V	-40 to +125 $^\circ\text{C}$

* About delay time

Signal input waveform vs output waveform

① Highside switch turn-on, turn-off

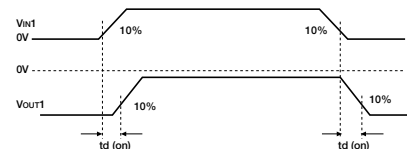

② Lowside switch turn-on, turn-off

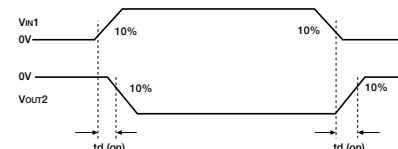

* $\Delta t: \Delta t = t_d(\text{on}) - t_d(\text{off})$

Measurement Circuit

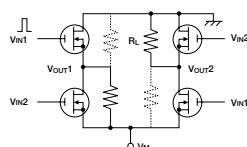

Conditions

$V_{CC}=10\text{V}, V_{IN}=10\text{V}$ (pulse)
 $V_M=85\text{V}$
 $I_O=0.41\text{A}$ ($R_L=207\Omega$)

* When pulse signal is inputted to V_{IN1} , R_L on solid line is ON and dotted line R_L is off.
 On the contrary, when pulse signal is inputted to V_{IN2} , R_L on dotted line is ON and solid line R_L is off.

External Dimensions (unit: mm)

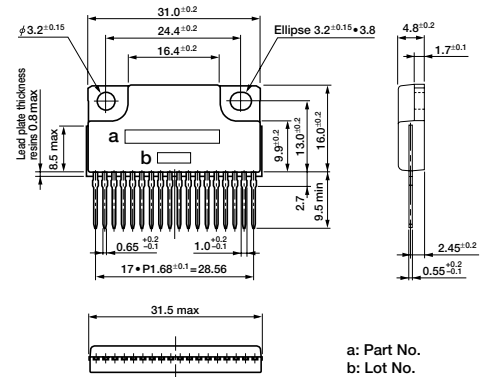

a: Part No.
 b: Lot No.

Block Diagram

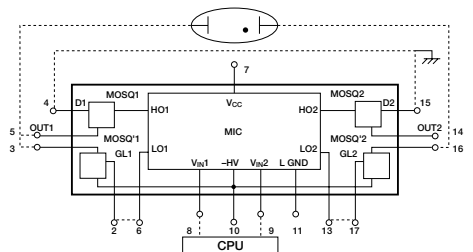

* Dotted Line: Outside Connection

Timing Chart

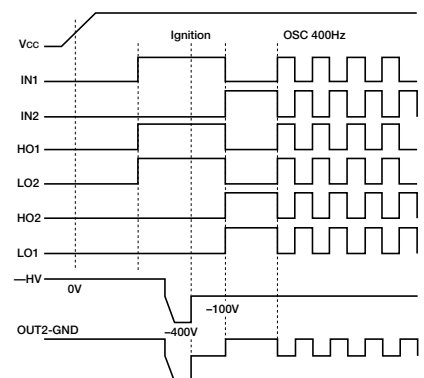

Electrical Characteristics

■ Quiescent circuit current

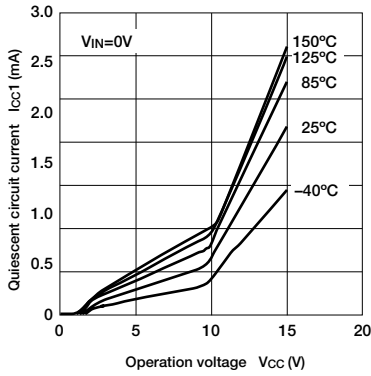

■ Quiescent circuit current supplied high voltage

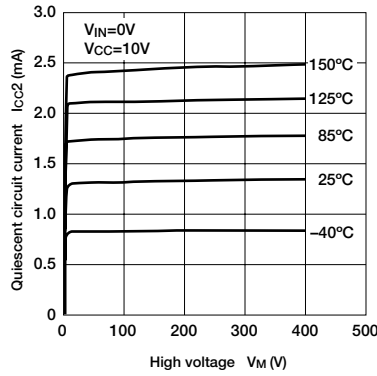

■ Operating circuit current

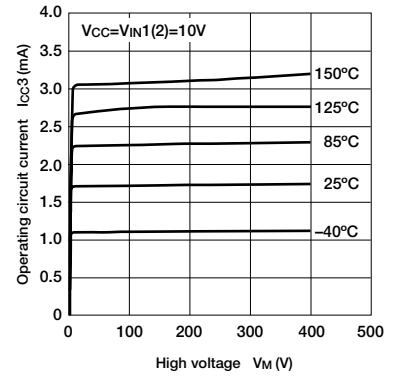

■ Quiescent circuit current supplied high voltage

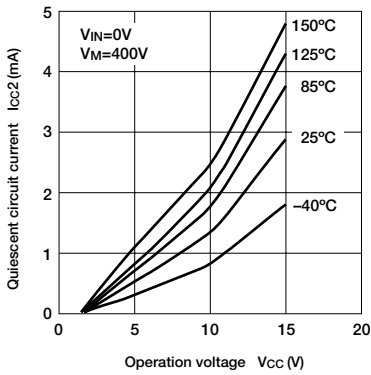

■ Quiescent circuit current supplied high voltage

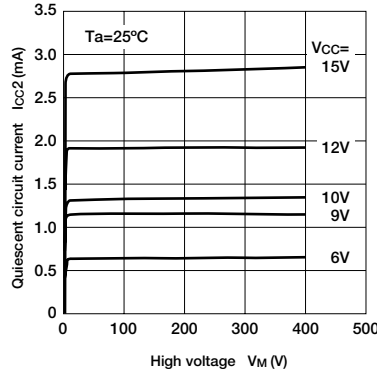

■ Operating circuit current

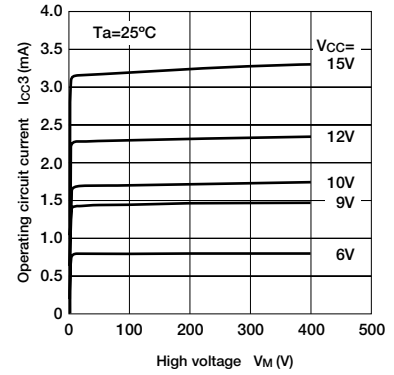

■ Output on-state voltage

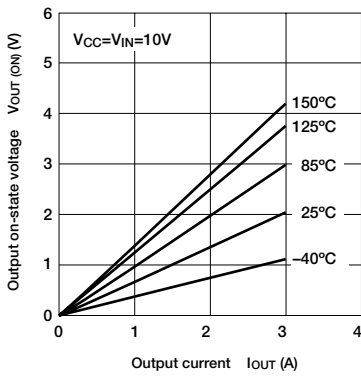

■ Input threshold voltage

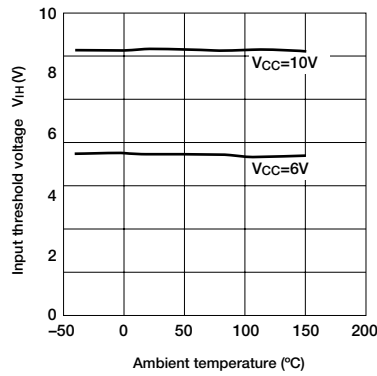

■ Gate drive voltage

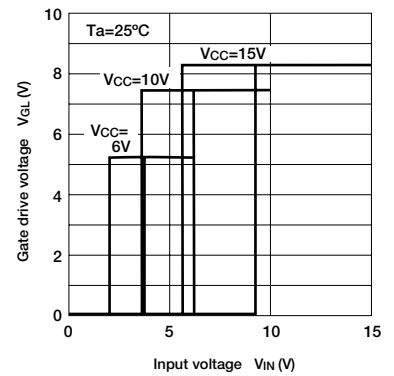

■ Output on-state voltage

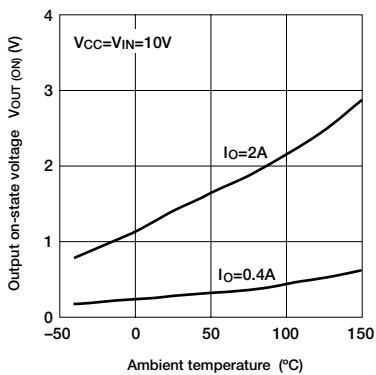

■ Input threshold voltage

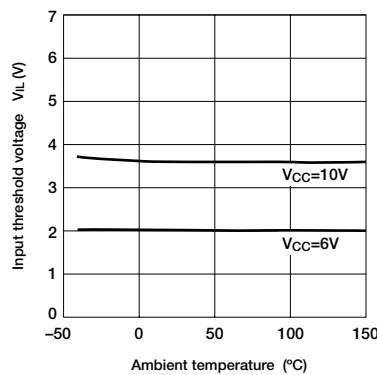

■ Gate drive voltage

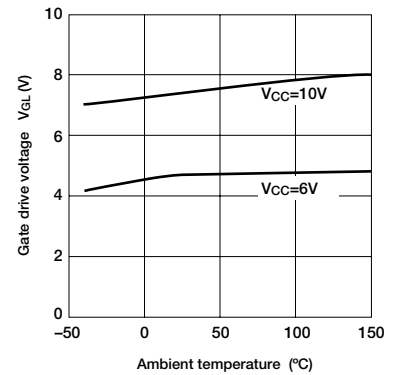

Electrical Characteristics

■ High side switch turn-on, off

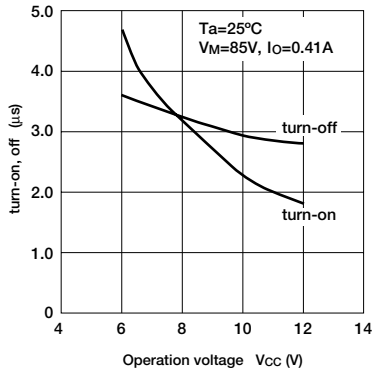

■ High side switch turn-on, off

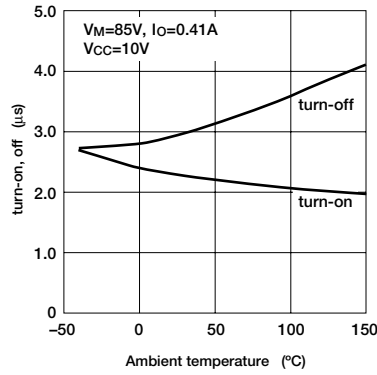

■ Low side switch turn-on, off

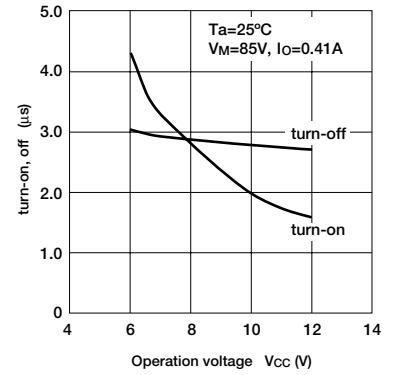

■ Low side switch turn-on, off

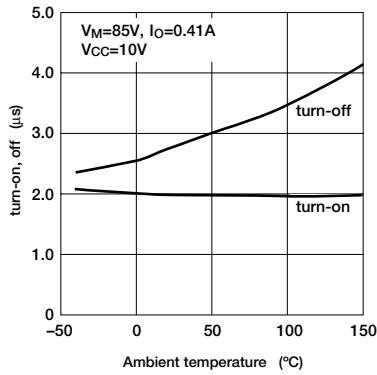

■ Transient thermal resistance characteristics

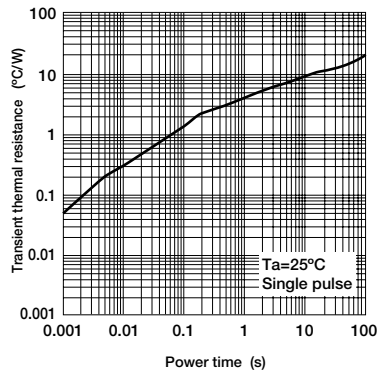

■ Safe operating area (Power MOS FET)

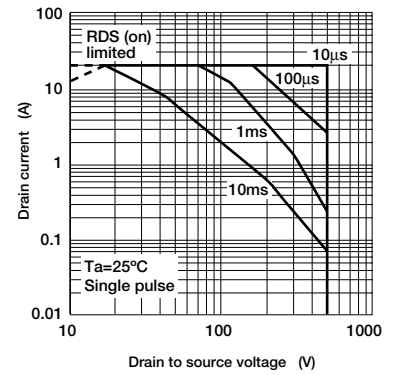

■ Power derating curve

