

**SINGAPORE CONSUMER PROTECTION
(SAFETY REQUIREMENTS)
REGISTRATION SCHEME**

**Information Booklet
2002 Edition**



**Safety Authority
Established under the Consumer Protection
(Safety Requirements) Regulations 1991**

**SINGAPORE CONSUMER PROTECTION (SAFETY REQUIREMENTS)
REGISTRATION SCHEME**

CONTENTS

Chapter		Page
1	Preface	2
2	Introduction	3
3	Who Should be Concerned with this Scheme	4
4	Key Regulations	5
5	Parties that Need to Apply for Registration	6
6	Controlled Goods and their Applicable Safety Standards	7-19
7	Safety Authority's Requirements	20-23
8	Registration of Supplier of Controlled Goods	24
9	Registration of Controlled Goods	25
10	Certificate of Conformity	26
11	Change in Particulars of Registered Supplier	27
12	Modification to Registered Controlled Goods	28-29
13	SAFETY Mark	30
14	Technical File	31
Appendix		
A	Definitions	33
B	Flow-chart for Registration of Supplier of Controlled Goods	34
C	Flow-chart for Registration of Controlled Goods	35
D	Flow-chart for Renewal of Registered Controlled Goods	36
E	Flow-chart for the Overall View of Registration Process	37
F	Form RS01	38
G	Guidelines for completing Form RS01	39
H	Form RS02	40
I	Form RS03	41
J	Examples of Non-controlled Goods	42
K	Specimen of Certificate of Conformity	43
L	Example of a completed 'Certificate of Conformity'	44
M	Specimen of 'Acknowledgement Receipt for Certificate of Conformity'	45
N	Guidelines for using SAFETY Mark on the Registered Controlled Goods	46-48
O	Guidelines for using SAFETY Mark in Advertisements or Publicity Materials	49-50
P	Conformity Assessment Bodies (Local)	51-52
Q	Conformity Assessment Bodies (Foreign - MRA)	53-54
R	Recognised Testing Laboratories	55-58
S	Drawings showing Acceptable and Not Acceptable Fan Motor Shaft used for Decorative Ceiling Fan	59
T	Drawing showing the 3 Expansion Bolts, Safety Cord, Expansion Bolt with Hook and Mounting Plate of Ceiling Fan	60
U	Drawings showing Acceptable and not Acceptable Distance Between the Bottom of the Burner Ring and Tip of the Gas Injector	61
V	Installation Instructions for Fixing Gas Cooker Elbow Joint	62
W	Acceptable and Non-acceptable 2-pin Mains Plug	63
X	Drawing showing a metal ring around glass bowl used with roaster	64

SINGAPORE CONSUMER PROTECTION (SAFETY REQUIREMENTS) REGISTRATION SCHEME

1 PREFACE

This information booklet serves as a guide to the definitions (Appendix A) and registration of controlled goods and other requirements related to the Singapore Consumer Protection (Safety Requirements) Registration Scheme or CPS Scheme and can be download from the website www.safety.org.sg.

The Safety Authority reserves the right to amend and introduce new requirements to the aforementioned scheme without reference to the holder of this booklet and encourages feedback from readers to ensure that improvements to this booklet could be made from time to time.

Our address is:

SPRING Singapore
Consumer Product Safety Department
2 Bukit Merah Central
Podium Block
5th Storey
Singapore 159835

Telephone: 1800-7733163
Facsimile: 62789885
Website: www.safety.org.sg

The Safety Authority also conducts training course for suppliers and retailers of controlled goods in Singapore. The training is for them to familiarise with the CPS Scheme and the requirements. Anyone who is interested in attending the course can register with the Safety Authority via telephone, facsimile or website. The Safety Authority will consolidate all requests and inform them of the course date.

SINGAPORE CONSUMER PROTECTION (SAFETY REQUIREMENTS) REGISTRATION SCHEME

2 INTRODUCTION

The objective of the Singapore Consumer Protection (Safety Requirements) Registration Scheme or CPS Scheme is to safeguard consumers' interest by ensuring home appliances, designated as controlled goods, meet the specified safety requirements.

Undoubtedly, consumers today are prepared to pay for products that are safe and of high quality. The development of a Consumer Protection (Safety Requirements) Registration Scheme is therefore consistent with the growing sophistication of consumers in Singapore.

The CPS Scheme is administered by SPRING Singapore as the Safety Authority since 1991 by Ministry of Trade and Industry (MTI) under the Consumer Protection (Safety Requirements) Regulations 2002. One of the roles of the Safety Authority under these Regulations is to ensure compliance by industry on the registration of thirty-nine (39) categories of controlled goods. The definitions and applicable safety standards of the controlled goods are provided on page 7 to 19. To further assist suppliers, some examples of non-controlled goods are identified in Appendix J.

Registration of controlled goods under the Consumer Protection (Safety Requirements) Regulations 2002 is based on Certificate of Conformity (COC) issued by designated third party Conformity Assessment Bodies (CABs). An overall view of the registration process is shown in Appendix E.

Six (6) more controlled goods were added to the First Schedule under the Consumer Protection (Safety Requirements) (Amendment) Regulations 2002 which make a total of forty-five (45) controlled goods. These six (6) controlled goods previously known as Prescribed Articles under Part IV of the Public Utilities (Electricity) Regulations (Cap 261, Rg 2) are found on page 18 and 19 of this booklet. The effective date of implementation is from 1 April 2003. All these six controlled goods currently available in the market must be registered by 1 April 2003.

All suppliers (please refer to Chapter 5) of controlled goods for consumers or for use in schools, institutions, hotels, offices, etc. (which are operated other than by staff and professionals) must first be registered with the Safety Authority as Registered Supplier. Registered Suppliers are required to register each model of controlled goods with the Safety Authority. The registration must be supported with **Certificate of Conformity (COC)** issued by designated **Conformity Assessment Bodies** located in **Singapore** or **countries of MRA partners**, i.e. **CABs (Local)** or **CABs (Foreign - MRA)** respectively.

Once the model has been registered with the Safety Authority, the controlled goods can then be advertised and/or supplied in Singapore.

We would like to draw your attention to **Regulation 4(1)** of the Regulations 2002, where it is stipulated that no person shall trade, supply or advertise for the purpose of supplying any of the controlled goods in Singapore after the specified dates, unless the controlled goods are registered by the Safety Authority and are affixed with the **SAFETY Mark**. Hence, merely labelling products or stamping receipts 'For Export Only' is not an excuse for not registering controlled goods. **A person guilty of an offence, shall be liable on conviction, to a fine not exceeding \$10,000/- or to imprisonment for a term not exceeding two years or to both**

SINGAPORE CONSUMER PROTECTION (SAFETY REQUIREMENTS) REGISTRATION SCHEME

3 WHO SHOULD BE CONCERNED WITH THIS SCHEME

Consumers

To safeguard consumers' interest, consumers are strongly advised to purchase controlled goods that are registered with the Safety Authority and are affixed with the SAFETY Mark. Registered controlled goods that have met the specified safety requirements help to prevent fire, electric shock, explosion, radiation and other hazards that could result in injuries or deaths to humans and/ or damages to private properties.

To assist in identifying the registered controlled goods, consumers can use the Register of Registered Controlled Goods available on the website <http://www.safety.org.sg> to guide them when making purchases.

Suppliers

Manufacturers, importers (including parallel importers), retailers and traders who are involved in advertising and/or supplying the controlled goods must ensure that their obligations under the Regulations 2002 are fulfilled.

This Information Booklet is to assist suppliers in understanding the requirements and procedures when they apply for registration of controlled goods. The Safety Authority will only accept applications from Registered Suppliers. A Register of Registered Suppliers is available on the website www.safety.org.sg.

SINGAPORE CONSUMER PROTECTION (SAFETY REQUIREMENTS) REGISTRATION SCHEME

4 KEY REGULATIONS TO NOTE

- Regulation 4(1): No person shall, in the course of any trade or business, supply or advertise for the purpose of supply any controlled goods after the effective date specified in the First Schedule unless-
- (a) such controlled goods are registered controlled goods conforming to the safety requirements specified by the Safety Authority for those goods; and
 - (b) such controlled goods have affixed to them the Safety Mark in accordance with Part III.
- Regulation 4(2) : Where any person contravenes paragraph (1), he shall be guilty of an offence under section 11(2) of the Act, and the Safety Authority may-
- (a) require such person to effect a recall of the controlled goods and keep the Safety Authority informed of the progress of such recall; and
 - (b) take such steps as may be necessary to inform users of the controlled goods of the potential danger of such goods.
- Regulation 8(1) : The registration of any controlled goods shall be valid for a period of 3 years or the period of validity of the certificate of conformity of the controlled goods, whichever is the less, and may be renewed.
- Regulation 24(4)(a) : A Registered Supplier who fails or neglects to effect a recall of the registered controlled goods required by the Safety Authority under paragraph (2)(b)(i) shall be guilty of an offence and shall be liable on conviction to a fine not exceeding \$2,000 or to imprisonment for a term not exceeding 12 months or to both.

SINGAPORE CONSUMER PROTECTION (SAFETY REQUIREMENTS) REGISTRATION SCHEME

5 PARTIES THAT NEED TO APPLY FOR REGISTRATION

Only one party in the chain of supply of the controlled goods in Singapore needs to register the controlled goods with the Safety Authority. No party shall be allowed to advertise and/or supply the controlled goods unless they have been registered with the Safety Authority. The registration is non-transferable and will be withdrawn when the party registered as '**Registered Supplier**' ceases to supply the controlled goods registered by it, for instances, where it ceases to carry on such business or is no longer registered with the Singapore Registry of Companies and Businesses (RCB).

Importer

Importers who import controlled goods that are meant for Singapore are required to apply for registration with the Safety Authority. No registration is needed if the controlled goods are meant for export only. However, these 'For Export Only' controlled goods shall not be advertised, supplied, displayed in any retail outlets and/or made available for sale in Singapore under any circumstances. Merely labelling the controlled goods or stamping the receipts with 'For Export Only' are also not allowed.

Parallel Importer

Any parallel importer of the same brand and model of controlled goods are also required to apply for registration.

Retailer

Retailers are only required to apply for registration if they import the controlled goods themselves.

Manufacturer



Unless another party in the chain of supply has already registered the controlled goods with the Safety Authority, manufacturers in Singapore who supply the controlled goods to the domestic market are required to apply for registration.

New Distributor

Since the **Certificate of Conformity (COC)** is not transferable, when a company (Registered Supplier) relegates its ownership of its registered controlled goods to another business entity, the latter has to re-register the controlled goods with the Safety Authority. Where the current Registered Supplier allows the new distributor to take over its existing registered controlled goods, submission of an authorisation letter from the former to the Safety Authority is required for the re-registration of the controlled goods for the latter. The letter must also indicate the effective date of taking over. Otherwise, the new distributor has to go to a **CAB (Local)** or **CAB (Foreign - MRA)** to obtain COC prior to having the controlled goods re-registered with the Safety Authority.





**SINGAPORE CONSUMER PROTECTION (SAFETY REQUIREMENTS)
REGISTRATION SCHEME**

6 CONTROLLED GOODS AND THEIR APPLICABLE SAFETY STANDARDS

Controlled Goods	Definitions	Singapore Standards	Equivalent Overseas Standards
<p>Air cooler</p> 	<p>An electrically operated appliance for agitating the air equipped to use water as a cooling medium and its associated regulator intended for use on single phase a.c. and d.c. circuits not exceeding 250V for household and similar purposes.</p>		<p>IEC 60335-2-98: 1997</p>
<p>Adaptor</p> 	<p>A device designed to supply a.c. or d.c. power from an a.c. or d.c. source, either by itself or as part of an accessory, for applications such as computers, telecommunication equipment, home entertainment equipment or toys.</p>	<p>SS 143 : 1988 with A1 and A2 or SS 143: 2000 (applicable for electronic appliances) SS 337: 1997 (applicable for computer / telephonic appliances)</p>	<p>IEC 60742: 1983 or IEC 61558-2-6: 1997 or IEC 61558-2-17: 1997 (applicable for electrical appliances) IEC 60065: 1985 with A1, A2 and A3 or IEC 60065: 1998 (applicable for electronic appliances) IEC 60950: 1991 with A1, A2, A3 and A4 (applicable for computer / telephonic appliances)</p>
<p>Any other audio products</p> 	<p>Any other electronic device (other than High-fidelity set) for the reproduction of sound, connected to the supply mains, either directly or indirectly.</p>	<p>SS 143 : 1988 with A1 and A2 or SS 143: 2000</p>	<p>IEC 60065: 1985 with A1, A2 and A3 or IEC 60065: 1998</p>



**SINGAPORE CONSUMER PROTECTION (SAFETY REQUIREMENTS)
REGISTRATION SCHEME**

6 CONTROLLED GOODS AND THEIR APPLICABLE SAFETY STANDARDS

Controlled Goods	Definitions	Singapore Standards	Equivalent Overseas Standards
<p>Cooking range</p> 	<p>A device for cooking and includes separate stationary ovens and grills, cooking table cookers, hob elements, grills and griddles which form part of cooking ranges, and ovens and grills for installation in walls except a cooking range having a mass of less than 18kg.</p>	<p>SS 146 : Part 2: 7:1988 with A1 or SS146: Part 2: 7: 1999</p>	<p>IEC 60335-2-6: 1986 or IEC 60335-2-6: 1997</p>
<p>Coffee maker, slow cooker, steam boat and similar appliances</p> 	<p>An electrically operated appliance that heats water up to high temperatures in the course of food and beverage preparation.</p>	<p>SS 146: Part 2: 2: 1997</p>	<p>IEC 60335-2-15: 1986 or IEC 60335-2-15: 1995</p>
<p>Components of the LPG gas system – Hose</p> 	<p>A hose for use in domestic Liquefied petroleum (LPG) vapour phase and liquefied petroleum gas or air appliances not exceeding 5KPa (50 mbar) operating pressure.</p>	<p style="text-align: center;">SS 233: 1980 or SS 233 : 1996</p>	
<p>Components of the LPG gas system – Regulator</p> 	<p>A non-adjustable device that maintains the outlet pressure constant at a nominal value upto and including 50 mbar, independent, within specified limits, of inlet pressure or flow rate.</p>	<p style="text-align: center;">SS281 : 1984</p>	



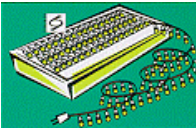

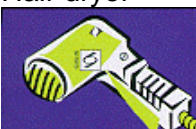
**SINGAPORE CONSUMER PROTECTION (SAFETY REQUIREMENTS)
REGISTRATION SCHEME**

6 CONTROLLED GOODS AND THEIR APPLICABLE SAFETY STANDARDS

Controlled Goods	Definitions	Singapore Standards	Equivalent Overseas Standards
<p>Components of the LPG gas system – Valve</p> 	<p>A device that is made from brass, bronze or aluminium forging, for use with domestic liquefied petroleum gas cylinders, for control of the direction and volume of flow of the liquefied petroleum gas.</p>	<p style="text-align: center;">SS 294: 1984 or SS 294 : 1998</p>	
<p>Decorative lighting fixture</p> 	<p>Lighting chains fitted with a series or parallel connected incandescent lamps for use either indoors or outdoors on supply voltages not exceeding 250 volts.</p>	<p>SS 263 : Part 10: 1990 or SS 263: Part 10: 2000</p>	<p>IEC 60598-2-20: 1982 with A1 and A2 or IEC 60598-2-20: 1998</p>
<p>Gas cooker</p> 	<p>A domestic appliance combining burners for cooking by gas.</p>	<p style="text-align: center;">EN 30-1-1: 1998 or AG 101: 1998</p>	
<p>Gas canister</p> 	<p>A non-refillable metallic container up to 1.4 litres capacity filled with liquefied petroleum gases.</p>	<p style="text-align: center;">SS 400 : 1997</p>	
<p>Hair dryer</p> 	<p>An electrically operated appliance intended to be used for the drying of hair of persons and incorporating heating elements</p>	<p>SS 146 : Part 2: 9: 1994 with A1 or SS 146: Part 2: 9: 1997</p>	<p>IEC 60335-2-23: 1986 or IEC 60335-2-23: 1996</p>

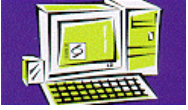

**SINGAPORE CONSUMER PROTECTION (SAFETY REQUIREMENTS)
REGISTRATION SCHEME**

6 CONTROLLED GOODS AND THEIR APPLICABLE SAFETY STANDARDS

Controlled Goods	Definitions	Singapore Standards	Equivalent Overseas Standards
<p>Home computer system (inclusive of monitor, printer, speaker and other mains operated accessories)</p> 	<p>A microprocessor based data system with compact, local computing and calculating power on high definition graphics and with flexible data communication interfacing.</p>	<p>SS 337: 1997</p>	<p>IEC 60950: 1991 with A1, A2, A3 and A4</p>
<p>High-fidelity set</p> 	<p>An electronic device for reproduction of sound, with little distortion, connected to the supply mains as the only energy source intended for domestic and similar general indoor use with a rated supply voltage not exceeding 250 volts rms.</p>	<p>SS 143 : 1988 with A1 and A2 or SS 143: 2000</p>	<p>IEC 60065: 1985 with A1, A2 and A3 or IEC 60065: 1998</p>
<p>Iron</p> 	<p>An electrically operated appliance with heated soleplate for ironing of clothes, for household and similar purposes.</p>	<p>SS 146: Part 2: 1: 1996</p>	<p>IEC 60335-2-3: 1993</p>
<p>Immersion water heater</p> 	<p>A portable household apparatus for heating liquid by immersing an electrically heated rod into it.</p>	<p>SS 146: Part 2: 14: 1998</p>	<p>IEC 60335-2-74: 1994</p>
<p>Kettle</p> 	<p>Namely an electrically operated household appliance for heating of water for consumption, having a rated capacity not exceeding 10 litres.</p>	<p>SS 146: Part 2: 2: 1997</p>	<p>IEC 60335-2-15: 1986 or IEC 60335-2-15: 1995</p>

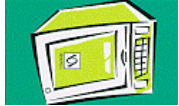
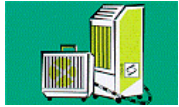

**SINGAPORE CONSUMER PROTECTION (SAFETY REQUIREMENTS)
REGISTRATION SCHEME**

6 CONTROLLED GOODS AND THEIR APPLICABLE SAFETY STANDARDS

Controlled Goods	Definitions	Singapore Standards	Equivalent Overseas Standards
<p>Laser disc set</p> 	<p>An electronic device for video recording and play-back or laser disc for play-back only connected to the supply mains, either directly or indirectly, and intended for domestic and similar general indoor use.</p>	<p>SS 143 : 1988 with A1 and A2 or SS 143: 2000</p>	<p>IEC 60065: 1985 with A1, A2 and A3 or IEC 60065: 1998</p>
<p>Microwave oven</p> 	<p>An electrically operated appliance for heating food and beverages using electromagnetic energy (microwaves) in one or more of the I.S.M. frequency bands between 300 MHz and 30 GHz and intended for household use. These appliances may also incorporate a browning function.</p>	<p>SS 146: Part 2: 10: 1994 with A1 or SS 146: Part 2: 10: 1998</p>	<p>IEC 60335-2-25: 1993 with A1 or IEC 60335-2-25: 1996</p>
<p>Mobile split air-conditioner</p> 	<p>An encased mobile assembly designed to provide delivery of conditioned air to an enclosed space, room or zone, including an electrically operated refrigeration system for cooling and possibly dehumidifying the air.</p>	<p>SS 146: Part 2: 16: 1998</p>	<p>IEC 60335-2-40: 1992 or IEC 60335-2-40: 1995</p>
<p>Mixer, blender, mincer and similar appliances</p> 	<p>An electrically operated machine for food and beverage preparation and intended for household use.</p>	<p>SS 146: Part 2: 13: 1998</p>	<p>IEC 60335-2-14: 1984 with A1 and A2 or IEC 60335-2-14: 1994</p>



**SINGAPORE CONSUMER PROTECTION (SAFETY REQUIREMENTS)
REGISTRATION SCHEME**

6 CONTROLLED GOODS AND THEIR APPLICABLE SAFETY STANDARDS

Controlled Goods	Definitions	Singapore Standards	Equivalent Overseas Standards
Portable cooking gas appliance 	A portable cooking appliance that uses liquefied petroleum gas, obtained from a gas canister (A non-refillable metal container up to 1.4 litres capacity filled with liquefied petroleum gases), as fuel.	SS 401: 1997	
Refrigerator 	A self-contained assembly consisting of a thermally insulated cabinet for the storage and preservation of foodstuffs above 0°C and of a refrigerating unit operating on the vapour compression principle and arranged to extract heat from within the cabinet, whether or not with one or more freezer compartments.	SS 146: Part 2: 17: 1998	IEC 60335-2-24: 1992 or IEC 60335-2-24: 1997
Rice cooker 	An electrically operated household appliance for cooking rice.	SS 146: Part 2: 2: 1997	IEC 60335-2-15: 1986 or IEC 60335-2-15: 1995



**SINGAPORE CONSUMER PROTECTION (SAFETY REQUIREMENTS)
REGISTRATION SCHEME**

6 CONTROLLED GOODS AND THEIR APPLICABLE SAFETY STANDARDS

Controlled Goods	Definitions	Singapore Standards	Equivalent Overseas Standards
<p>Room air-conditioner</p> 	<p>A self-contained assembly designed as a unit, primarily for mounting in a window or through the wall or as a console. It is designed primarily to provide free delivery of conditioned air to an enclosed space, room or zone (conditioned space). It includes a prime source of refrigeration for cooling and dehumidification and means for the circulation and the cleaning of air, and a drain arrangement for collecting and/or disposing any condense. It may also include means for humidifying, ventilating or exhausting air.</p>	<p>SS 146: Part 2: 16: 1998</p>	<p>IEC 60335-2-40: 1992 or IEC 60335-2-40: 1995</p>
<p>Television / video display unit</p> 	<p>Namely an electronic device for receiving and displaying information from a transmitting station or local source. The device is to be connected to the supply mains either directly or indirectly, and intended for domestic and similar general indoor use.</p>	<p>SS 143 : 1988 with A1 and A2 or SS 143: 2000</p>	<p>IEC 60065: 1985 with A1, A2 and A3 or IEC 60065: 1998</p>
<p>Table / standing fan</p> 	<p>An electrically operated appliance for agitating the air, and their associated regulator intended for use on single-phase a.c. and d.c. circuits not exceeding 250V and intended for household and similar purposes.</p>	<p>SS 146: Part 2: 18: 2000</p>	<p>IEC 60335-2-80: 1997</p>



**SINGAPORE CONSUMER PROTECTION (SAFETY REQUIREMENTS)
REGISTRATION SCHEME**

6 CONTROLLED GOODS AND THEIR APPLICABLE SAFETY STANDARDS

Controlled Goods	Definitions	Singapore Standards	Equivalent Overseas Standards
<p>Table lamp/ standing lamp</p> 	<p>A portable general purpose luminaire, other than handlamps, for use with tungsten filament, tubular fluorescent and other discharge lamps connected to the supply mains, either directly or indirectly.</p>	<p>SS 263 : Part 6:1989 or SS 263: Part 6: 1998</p>	<p>IEC60598-2-4: 1979 A1, A2 and A3 or IEC 60598-2-4: 1997</p>
<p>Toaster, grill, roaster, hot plate, deep fryer, wok and similar appliances</p> 	<p>Namely electric appliances connected to the supply mains, which make use of direct or indirect (e.g. heated medium such as air and cooking oil) heat for food preparation and intended for household use.</p>	<p>SS 146: Part 2: 15: 1998 applicable for toaster, grill, oven and similar appliances)</p>	<p>IEC 60335-2-9: 1993 (applicable for toaster, grill, oven and similar appliances) IEC 60335-2-6: 1986 (applicable for hot plate and similar appliances) IEC 60335-2-13: 1993 with A1 and/or with A2 (applicable for deep fryer, electric wok and similar appliances)</p>
<p>Video cassette recorder</p> 	<p>An electronic device for video recording and playback or for playback only, connected to the supply mains either directly or indirectly, and intended for domestic and similar general indoor use.</p>	<p>SS 143 : 1988 with A1 and A2 or SS 143: 2000</p>	<p>IEC 60065: 1985 with A1, A2 and A3 or IEC 60065: 1998</p>





**SINGAPORE CONSUMER PROTECTION (SAFETY REQUIREMENTS)
REGISTRATION SCHEME**

6 CONTROLLED GOODS AND THEIR APPLICABLE SAFETY STANDARDS

Controlled Goods	Definitions	Singapore Standards	Equivalent Overseas Standards
Vacuum cleaner 	A machine which removes dirt and dust by the suction produced by a motor-driven air pump, and intended for household use and similar purposes.	SS 146 : Part 2: 4:1996	IEC 60335-2-2: 1993
Washing machine 	An electrically operated appliance intended for washing clothes and textiles (whether or not with means for water heating), for water extraction or for drying.	SS 146 : Part 2: 3:1995	IEC 60335-2-7: 1993
Wall fan / Ceiling fan 	An electric fan and its associated regulator intended for mounting on the wall or ceiling and for use on a single-phase a.c. and d.c. circuit not exceeding 250V for household and similar purposes.	SS 146 Part 2 : 18 : 2000 and SS 360: 1992 (sub-clauses 5.7 & 5.8 only) (applicable for ceiling fan)	IEC 60335-2-80: 1997 and SS 360: 1992 (sub-clauses 5.7 & 5.8 only) (applicable for ceiling fan)





**SINGAPORE CONSUMER PROTECTION (SAFETY REQUIREMENTS)
REGISTRATION SCHEME**

6 CONTROLLED GOODS AND THEIR APPLICABLE SAFETY STANDARDS

Controlled Goods	Definitions	Singapore Standards
<p>3-pin rectangular type 13-amp plug</p> 	<p>A portable fused device having projecting pins designed to engage with the contacts of a corresponding socket-outlet. A plug also incorporates means for the electrical connection and the mechanical retention of a suitable flexible cord.</p>	<p>SS 145: Part 1: 1997</p>
<p>Fuse (≤ 13 amperes) for use in plug</p> 	<p>A device that, by the fusion of one or more of its specially designed and proportioned components, opens the circuit in which it is inserted and breaks the current when this exceeds a given value for a sufficient time. The fuse comprises all the parts that form the complete device.</p>	<p>SS 167: 1977</p>
<p>3-pin round type 15-amp plug</p> 	<p>A device carrying three metallic plug pins substantially cylindrical in form intended for engagements with corresponding socket contacts arranged for connection to a suitable flexible cord.</p>	<p>SS 472: 1999</p>
<p>Multi-way Adaptor</p> 	<p>An Adaptor having more than one set of socket contacts (the socket contacts may or may not be of the same type or rating as the plug pin portion)</p>	<p>SS 246: 1996</p>





**SINGAPORE CONSUMER PROTECTION (SAFETY REQUIREMENTS)
REGISTRATION SCHEME**

6 CONTROLLED GOODS AND THEIR APPLICABLE SAFETY STANDARDS

Controlled Goods	Definitions	Singapore Standards
<p>3-pin portable socket-outlet</p> 	<p>An accessory having a set of three socket-contacts designed to engage with the pins of a corresponding plug and having means for the electrical connection of appropriate cables or flexible cords, for connection to, or integral with, a flexible cord, and which can be easily moved from one place to another while connected to the supply.</p>	<p>SS145: Part 2: 1997 and SS 358: Part 5: 1998</p>
<p>Portable cable reel</p> 	<p>A device comprising a flexible cable or cord attached to a reel so constructed that the flexible cable may be completely wound onto the reel, and provided with a plug and one or more socket outlets.</p>	<p>SS 307: 1996</p>
<p>Instantaneous electric water heater</p> 	<p>An electrically operated stationary appliance for household and similar purposes and intended for heating water below boiling temperature with its rated voltage not more than 250 V for single-phase appliances and 480 V for other appliances.</p>	<p>SS 146: Part 1: 1994 and SS 146: Part 2: 5: 1999</p>
<p>Mains pressure electric storage water heater</p> 	<p>An electrically operated stationary appliance for household and similar purposes and intended for storing and heating water below boiling temperature with its rated voltage not more than 250 V for single-phase appliances and 480 V for other appliances.</p>	<p>SS 146: Part 1: 1994 and SS 146: Part 2: 8: 1999</p>



**SINGAPORE CONSUMER PROTECTION (SAFETY REQUIREMENTS)
REGISTRATION SCHEME**

6 CONTROLLED GOODS AND THEIR APPLICABLE SAFETY STANDARDS

Controlled Goods	Definitions	Singapore Standards
<p>Residual Current Circuit Breaker (RCCB)</p> 	<p>Residual Current Circuit Breaker (RCCB) namely a device intended to protect persons against indirect contact, the exposed conductive parts of the installation being connected to an appropriate earth electrode.</p>	<p>SS 97: Part 1: 2000</p>
<p>3-pin 13-amp socket-outlet</p> 	<p>3-pin 13-amp socket-outlet namely a 13A shuttered socket-outlet in single or multiple arrangements with associated controlling switches, for flush mounting in suitable box or for surface or panel mounting. The socket-outlet is suitable for the connection of portable appliances, sound-version equipment, luminaries, etc., in a.c. circuits only operating at voltage not exceeding 250 V r.m.s. at 50 Hz.</p>	<p>SS 145: Part 2: 1997</p>
<p>3-pin round type 15-amp socket-outlet</p> 	<p>3-pin round type 15-amp socket-outlet namely a 15A shuttered socket-outlet which contains switch connected between the current carrying contact of the socket-outlet and the relevant supply terminal for flush mounting in suitable box or for surface or panel mounting. The socket-outlet is suitable for the connection of electrical appliances in a.c. circuits only operating at voltage not exceeding 250 V r.m.s. at 50 Hz.</p>	<p>SS 472: 1999</p>
<p>Domestic electric wall switch</p> 	<p>Domestic electric wall switch namely a manually operated general purpose switch for a.c. only with a rated voltage not exceeding 440V and a rated current not exceeding 63A, intended for household and similar fixed-electrical installations, either indoors or outdoors.</p>	<p>SS 227: Part 1: 2000</p>

**SINGAPORE CONSUMER PROTECTION (SAFETY REQUIREMENTS)
REGISTRATION SCHEME**

6 CONTROLLED GOODS AND THEIR APPLICABLE SAFETY STANDARDS

Controlled Goods	Definitions	Singapore Standards
<p>Ballast for tubular fluorescent lamp</p> 	<p>Ballast for tubular fluorescent lamp namely a unit inserted between the supply and one or more fluorescent lamps which, by means of inductance, capacitance or a combination of inductance and capacitance or electronic circuitry, serves mainly to limit the current of the lamp(s) to the required value.</p>	<p>SS 490: Part 2: 8: 2001 (magnetic ballast) or SS 490: Part 2: 3: 2002 (electronic ballast)</p>
<p>Isolating transformer for downlight fitting</p> 	<p>Isolating Transformer for downlight fitting namely a transformer with input and output windings which are electrically separated to limit hazards due to accidental simultaneous contact with earth and live parts or metal parts which may become live in the event of an insulation failure.</p>	<p>IEC 61558-2-6: 1997 or IEC 61347-2-2: 2000 (electronic isolating transformer)</p>

**SINGAPORE CONSUMER PROTECTION (SAFETY REQUIREMENTS)
REGISTRATION SCHEME**

7 SAFETY AUTHORITY'S REQUIREMENTS

The Safety Authority monitors the safety of the controlled goods sold in Singapore by investigating all complaints, incidents and accidents reported to the authority. Experiences gained are translated into the Safety Authority's Requirements. These requirements are to be fulfilled in addition to the applicable safety standards.

No	Items	Requirements
Applicable to all products		
1	Test certificate / Test report	Test certificate / Test report more than three (3) years old shall be rejected.
Applicable to all electrical products		
2	All appliances	All appliances must be tested to 230 VAC.
3	Voltage selector (voltage mis-match test)	Appliance fitted with voltage selector shall be tested as follows: Connect appliance to 230 VAC mains with voltage selector switch to settings not suitable for operation at 230 VAC.
4	Tropical condition test	All appliances (with tropical test requirements in applicable Standards) shall comply with the tropical condition test as stated in the relevant IEC Standards.
5	Class I appliances (3-pin mains plug)	All Class I appliances must be fitted with 3-pin mains plugs complied with SS 145/SS 472 that are registered with the Safety Authority.
6	Class II appliances (mains plug)	a) All Class II appliances must be fitted with 2-pin mains plug (Appendix W) complied with IEC 83: 1975 (Standard C5, Version II) or EN 50075. b) Class II appliances that are fitted with 3-pin mains plugs must use plugs that are complied with SS 145 and registered with the Safety Authority.
7	Appliances rated ≥ 3 kW or connected to fixed wiring	Electric appliance ≥ 3 kW must be connected to fixed wiring. All connection to fixed wiring must be in accordance with Code of Practice CP5.
8	Detachable power cord set (consists of mains plug, mains cord and appliance connector)	Detachable power cord set must be listed in the test report critical component list.
9	Circuit diagrams	Circuit diagrams must be indicated with component's values for products tested to IEC 60065 and IEC 60950.
10	Circuit diagrams of electronic modules in electrical appliances	Circuit diagrams of the electronic modules in the electrical appliances must be provided.
11	Controlled goods likely to be treated as toy by children	Controlled goods, having an enclosure, which is shaped and decorated so that it is likely to be treated as a toy by children, shall not be accepted for certification and registration.

**SINGAPORE CONSUMER PROTECTION (SAFETY REQUIREMENTS)
REGISTRATION SCHEME**

7 SAFETY AUTHORITY'S REQUIREMENTS

No	Items	Requirements
Applicable to electric airpot		
12	Reboil switch	No part of the reboil switch is allowed to protrude into the water pot, even if it is located above the maximum water level mark.
Applicable to AC adaptor		
13	3-pin AC adaptor	Test report showing that the 3-pin complied with sub-clauses 12.1 & 12.3 of SS 246 must be submitted.
14	2-pin AC adaptor	The 2-pin (Appendix W) shall comply with IEC 83: 1975 (Standard C5) or EN 50075
15	Detachable power supply cord set not supplied by Registered Supplier	Registered Supplier who is not supplying the detachable power supply cord set together with the AC Adaptor must provide written instruction to its customer on the type of approved detachable power cord set to use.
Applicable to computer products		
16	CD/DVD ROM (used in personal computer)	Test certificate showing that CD/DVD ROM has complied with IEC 825 must be provided.
17	Modem Card (used in personal computer)	Modem card incorporated in the personal computer must be tested at set level (sub-clauses 5.1 & 6 of IEC 60950) or at component level.
Applicable to ceiling fan and cycle fan		
18	Ceiling fan and cycle fan	<ul style="list-style-type: none"> a) These appliances must be tested to sub-clauses 5.7 and 5.8 of SS 360: 1992. b) Installation instruction must mention the 3 expansion bolts for fastening the main suspension, safety cord, expansion bolt with hook for fastening safety cord and mounting plate. (Appendix T) c) Drawing (Appendix S) to show that the wires within the motor shaft are not stressed must be provided.
Applicable to portable socket-outlet and portable cable reel		
19	3-pin portable socket-outlet and portable cable reel	If residual current device (RCD) is incorporated, its tripping current must be less than 30mA and operating time must be less than 0.1 second and testing to sub-clauses 9.9.2.1, 9.9.2.2, 9.9.2.3 and 9.16 of SS 97: Part 1: 2000 are required.

**SINGAPORE CONSUMER PROTECTION (SAFETY REQUIREMENTS)
REGISTRATION SCHEME**

7 SAFETY AUTHORITY'S REQUIREMENTS

No	Items	Requirements
Applicable to Roaster		
20	Roaster	A metal ring (Appendix X) must be provided to prevent the roaster from falling off in case the glass bowl shattered.
Applicable to gas appliances		
21	Test pressure of town gas for gas appliances	All gas appliances must be tested to 20 mbar for town gas.
22	Gas appliances tested to EN 30-1-1: 1998	Testing to sub-clause 6.1.6 (Temperature of the LPG cylinder and its compartment) and sub-clause 6.2.1 (Ignition, cross-lighting and flame stability) must be carried out.
23	Flame failure device (FFD) incorporated in gas appliances	<p>a) Test report showing that the FFD complied with EN 126: 1995 or EN 125: 1991 for gas appliance tested to EN 30-1-1 or AG 204: 1984 for gas appliance tested to AG 101 at component level must be provided.</p> <p>b) Testing to sub-clause 6.1.3 of EN 30-1-1 or sub-clause 3.6.13 of AG 101 at set level must be carried out.</p>
24	Distance between burner and injector	The distance (Appendix U) between bottom of burner ring and tip of the injector must not be too far apart such that the flame may be heating part of the burner instead of the cooking appliance.
25	Gas oven	It is compulsory for all gas ovens to be fitted with flame failure device.
26	Glass viewing door for gas hob and gas oven	Test report showing that the glass of the viewing door complied with BS 3193: 1993 (Specification for Thermally Toughened Glass Panels for use in domestic appliances) must be provided.
27	Toughened glass gas hob	<p>a) A brochure, entitled "Toughened Glass – A Shattering Experience?" must be included for each toughened glass gas hob put up for sale. (Order for the brochure can be placed with the Safety Authority)</p> <p>b) Additional testing and compliance with sub-clauses 2.1.14, 2.1.15, 2.1.17, 2.10.15, 2.11.2.2 & 5.7.5 of AG 101 are required for toughened glass gas hob tested to EN 30-1-1: 1998.</p>
28	Gasket for elbow joint of gas cooker	Installation instruction must mention about the fixing of gasket for the elbow joint, if applicable. (Appendix V)
29	Glass-ceramic gas hob (simulated gas explosion test)	The gas hob must be subject to 'simulated gas explosion' test. The hob is filled with an explosive mixture of gas and detonated with a source of ignition.
Applicable to Residual Current Circuit Breaker (RCCB)		
30	RCCB	Registration of RCCB is limited to 30 mA sensitivity and the operating time must be less than 0.1 second. Electronic RCCB will not be accepted for registration.

**SINGAPORE CONSUMER PROTECTION (SAFETY REQUIREMENTS)
REGISTRATION SCHEME**

7 SAFETY AUTHORITY'S REQUIREMENTS

No	Items	Requirements
Applicable to electric instantaneous and storage water heater		
31	Instantaneous electric water heater and mains pressure electric storage water heater	Heating elements used must not be of the "bare-element" type.
32	Water heater incorporated with residual current device(RCD)	Testing to sub-clauses 9.9.2.1, 9.9.2.2, 9.9.2.3 and 9.16 of SS 97: Part 1: 2000 are required.

SINGAPORE CONSUMER PROTECTION (SAFETY REQUIREMENTS) REGISTRATION SCHEME

8 REGISTRATION OF SUPPLIER OF CONTROLLED GOODS

Suppliers who wish to supply the controlled goods into Singapore would first have to register with the Safety Authority before submitting their controlled goods to a **CAB (Local)** or **CAB (Foreign - MRA)** for certification. The suppliers having completed the registration process with the Safety Authority will thereafter be referred to as '**Registered Suppliers**'. The Registered Suppliers can decide later whether or not to supply the controlled goods. A flow-chart for registration of supplier of controlled goods is found in Appendix B.

To be a Registered Supplier, the supplier shall submit the following to the Safety Authority for registration (no registration fee is required):

- a) Duly completed Form RS01 (Appendix F).
- b) 'Certificate of Incorporation of Private Company' issued by the Singapore Registry of Companies and Businesses (RCB).

SINGAPORE CONSUMER PROTECTION (SAFETY REQUIREMENTS) REGISTRATION SCHEME

9 REGISTRATION OF CONTROLLED GOODS

When the Registered Suppliers decide to supply the controlled goods, they shall submit them to a **CAB (Local)** or **CAB (Foreign - MRA)** (Appendix P & Q) for certification. The CAB (Local) or CAB (Foreign - MRA) shall, upon receipt of the applications, issue **certification numbers** to the Registered Suppliers to assist them in preparation of the SAFETY Mark. After the controlled goods have been successfully certified, the CAB (Local) or CAB (Foreign - MRA) shall issue **Certificates of Conformity (COC)** (Appendix K) to the Registered Suppliers. The Registered Suppliers can then submit the COC to the Safety Authority to register the certified controlled goods. In relation to Regulations 7(1)(b), 7(6) and 8(2), registration with COC from a CAB (Local) as well as registration with COC from a CAB (Foreign-MRA) will be automatic and effected immediately. However, additional requirements may be imposed under the terms and conditions of a particular MRA. The Safety Authority shall, upon receipt of the COC, issue an **Acknowledgement Receipt for Certificate of Conformity** (Appendix M) to the Registered Suppliers. With the acknowledgement, the Registered Suppliers can then affix the **SAFETY Mark** (Chapter 13) either on the registered controlled goods or their packaging and commence supply.

The Registered Suppliers are required to maintain a technical file on the registered controlled goods as specified in Chapter 14. A flow-chart for registration of controlled goods is found in Appendix C.

Registered Suppliers who have test reports issued by the **Recognised Testing Laboratories (RTLs)** (Appendix R) or **testing laboratories** of the **CABs (Local)** (Appendix P) or **CABs (Foreign - MRA)** (Appendix Q) can only apply to the **CABs (Local)** for certification of their controlled goods. The CABs (Local) shall certify the controlled goods without re-testing unless the test reports are found not to be in full compliance to the safety requirements specified in this booklet.

In cases where there are modifications to the registered controlled goods, the Registered Suppliers are required to inform the CABs (Local) or CABs (Foreign - MRA) or the Safety Authority depending on the type of modifications described in Chapter 12.

To register the certified controlled goods, the Registered Suppliers shall submit the following to the Safety Authority:

- a) Non-refundable registration fee of \$187.20 (4% GST included) per model in cheque made payable to "Standards, Productivity and Innovation Board".
- b) The COC issued by CABs (Local) or CABs (Foreign - MRA).

SINGAPORE CONSUMER PROTECTION (SAFETY REQUIREMENTS) REGISTRATION SCHEME

10 CERTIFICATE OF CONFORMITY

The **Certificate of Conformity (COC)** is valid for **three (3) years**. Registered Suppliers who wish to continue supplying their registered controlled goods beyond three (3) years shall approach the CABs (Local) or CABs (Foreign - MRA) for re-certification before their COC expire regardless of whether there are changes to the registered controlled goods or not. A new COC bearing the same certification number shall be issued. The Registered Suppliers shall submit the new COC to the Safety Authority for renewal of the registered controlled goods. A flow-chart for renewal of registered controlled goods is found in Appendix D.

Registered Suppliers who own COC without registering with the Safety Authority are not allowed to supply the certified controlled goods to the domestic market as their goods will be deemed as '**non-registered controlled goods**'. Any suppliers who supply non-registered controlled goods shall be guilty of an offence under **Section 11(2) of the Consumer Protection (Trade Descriptions and Safety Requirements) Act (Chapter 53)**.

To renew the registered controlled goods, the Registered Suppliers shall submit the following to the Safety Authority:

- a) Non-refundable renewal fee of S\$52 (4% GST included) per model in cheque made payable to "Standards, Productivity and Innovation Board".
- b) The new COC issued by CABs (Local) or CABs (Foreign - MRA).

SINGAPORE CONSUMER PROTECTION (SAFETY REQUIREMENTS) REGISTRATION SCHEME

11 CHANGE IN PARTICULARS OF REGISTERED SUPPLIER

In cases where there are changes to the particulars specified below of the Registered Suppliers, the Registered Suppliers are required to notify the Safety Authority **not less than two (2) weeks** before such occurrence under Regulation 15 of the Consumer Product (Safety Requirements) Regulations 2002.

- i) Company's name;
- ii) Company's registered address;
- iii) Name and title of person authorised to represent the company;
- iv) Telephone number;
- iii) Facsimile number;
- vi) Email address, etc.

The Registered Suppliers shall submit the following to the Safety Authority:

- a) Form RS02 (Appendix H).
- b) Certificate of Incorporation on Change of Name of Company issued by RCB, if applicable.

**SINGAPORE CONSUMER PROTECTION (SAFETY REQUIREMENTS)
REGISTRATION SCHEME**

12 MODIFICATION TO REGISTERED CONTROLLED GOODS

Modification (including technical and non-technical changes) refers to any change made to the registered controlled goods. Non-technical changes are (i) colour change; (ii) change relating only to factory location but without change in the manufacturing process (including testing facilities) or a change of the manufacturer; and (iii) change in the year of production.

The Registered Suppliers may approach the Safety Authority to determine whether re-certification of the registered controlled goods is required as a result of modification.

The Registered Suppliers shall update their technical file on the registered controlled goods with details of the change.

In a case where there is modification to the registered controlled goods, the following **scenarios** shall apply:

- a) If the modification does not result in a change in the model number even though the change is a technical one:
 - i) The controlled goods do not have to be re-registered with the Safety Authority.
 - ii) The Registered Supplier only needs to submit the modification to the CABs (Local) or CABs (Foreign - MRA) for re-certification. The Registered Supplier is to update the technical file with the test report and certification attesting that the modification still meets the safety standard requirements.

- b) If the modification does not result in a change in the model number and the change is a non-technical one, which does not affect the safety of the controlled good:
 - i) The controlled goods do not have to be re-registered with the Safety Authority.
 - ii) The controlled goods do not have to be re-certified with the CABs (Local) or CABs (Foreign - MRA).
 - iii) The Registered Supplier only needs to update the technical file with the modification, e.g. merely change(s) in the aesthetics that does (do) not affect the safety of the controlled goods.
 - iv) The Registered Supplier shall be responsible for ensuring that the modification does not compromise the safety of the controlled goods.

SINGAPORE CONSUMER PROTECTION (SAFETY REQUIREMENTS) REGISTRATION SCHEME

12 MODIFICATION TO REGISTERED CONTROLLED GOODS

- c) If the modification results in a change in the model number and the change is a technical one:
- i) The controlled goods have to be re-registered with the Safety Authority as per procedure indicated in Chapter 9.
 - ii) The controlled goods have to be re-certified with the CABs (Local) or CABs (Foreign - MRA) as per procedure indicated in Chapter 9.
 - iii) A new COC bearing a new certification number is required.
 - iv) The Registered Supplier needs to create a new technical file.
- d) If the modification results in a change in the model number even though the change is a non-technical one and does not affect the safety of the controlled goods:
- i) The controlled goods do not have to be re-certified with the CABs (Local) or CABs (Foreign - MRA).
 - ii) The controlled goods have to be re-registered with the Safety Authority. The Registered supplier is to declare clearly all the non-technical change(s) in Form RS03 (Appendix I) and submit it to the Safety Authority together with the registration fee of \$187.20 (4% GST included) and clear photographs of the external view (i.e. showing the complete appliance); internal view (i.e. showing the safety components); rating label; mains plug, etc.
 - iii) The Safety Authority shall issue a Certificate of Conformity with new certification number to the new model number of the controlled goods to the Registered Supplier if the modification is accepted by the Safety Authority. Thereafter, the Registered Supplier can affix the SAFETY Mark using the new certification number and commence supply of the controlled goods.
 - iv) The Registered Supplier needs to create a new technical file.

SINGAPORE CONSUMER PROTECTION (SAFETY REQUIREMENTS) REGISTRATION SCHEME

13 SAFETY MARK

Objective and rationale

Marking of registered controlled goods will enable consumers to differentiate between the registered and non-registered controlled goods and to participate in the enforcement. It also serves as a deterrent and a means to check for non-registered controlled goods in the market.

Marking

All controlled goods registered with the Safety Authority must bear the SAFETY Mark before they can be supplied to the Singapore market. Registered Suppliers are responsible for ensuring that their registered controlled goods are affixed with the SAFETY Mark in accordance to the guidelines stipulated by the Safety Authority as provided for in Appendix N. The Safety Authority will conduct spot-checks on manufacturers' / importers' / traders' warehouses when it is deemed necessary.

Where to apply the SAFETY Mark

The SAFETY Mark can either be affixed on the controlled goods or their packaging (to be affixed in a prominent location).

Preparation of SAFETY Mark

The CABs (Local) or CABs (Foreign - MRA) shall allocate certification numbers to the Registered Suppliers that have submitted controlled goods for the purpose of certification. The allocated certification numbers are to help Registered Suppliers in preparing the marking of the controlled goods in advance. It does not imply that the controlled goods have been certified by the CABs (Local) or CABs (Foreign - MRA) or registered with the Safety Authority. Registered Suppliers shall mark the controlled goods **ONLY** upon receiving the '**Acknowledgement Receipt for Certificate of Conformity**'.

Certification Number

The certification number (XXYYYY-ZZ) is a unique number issued by the CABs (Local) or CABs (Foreign - MRA) which is traceable to the Registered Suppliers and the registered controlled goods. The connotation of the certification number is as follows:

XX	=	year of certification (e.g. 01 for year 2001)
YYYY	=	serial number (e.g. 1234)
ZZ	=	CAB identity code (e.g. 11 for CAB 'A')

Using SAFETY Mark in Advertisements or Publicity Materials

Please refer to Appendix O for the guidelines.

SINGAPORE CONSUMER PROTECTION (SAFETY REQUIREMENTS) REGISTRATION SCHEME

14 TECHNICAL FILE

Every Registered Supplier in Singapore is required to maintain technical files of all their registered controlled goods as required in Regulation 16 of Regulations 2002. The contents of the technical files are specified in the table below. These files are to be maintained by the Registered Suppliers for **at least ten (10) years** from the date of expiry of the COC or the last renewed COC.

The maintenance of the technical files is necessary to enable the Safety Authority to carry out its investigation duties in the event of a complaint, incident or accident. Upon receiving request made by the Safety Authority, the Registered Suppliers must provide the relevant technical files to the Safety Authority within **seven (7) calendar days**.

In addition, the Registered Suppliers shall be responsible for the regular updating of the technical files especially if there have been **modifications** made to the registered controlled goods. Supplementary testing and certification are required if there are modifications with safety implications.

LIST OF DOCUMENTS TO BE INCLUDED IN THE TECHNICAL FILE

No.	Type of Document
1	Certificate of Conformity (in English version <u>only</u>)
2	Test Reports (in English version <u>only</u>)
3	Full Electrical Wiring/Circuit Diagrams or Service Manual (Circuit diagrams must indicate the component's values, or alternatively, be supported with Bill of Material/Part List.)
4	Photographs showing exterior (whole, front, top and rear view of controlled goods, nameplate, rating label, mains plug, etc.) and interior (critical safety components) views. Polaroid photographs as well as photocopies (in black and white) are <u>not</u> acceptable. Photographs for similar/derived models must also be kept together with the photographs of the basic model.
5	Rating Label (if it is not clear in the photograph) To provide an original or clear photograph or artwork.
6	User's Instruction Manual (English version must be included)
7	Record of Modification , if any

Note:

Registered Suppliers are strongly encouraged to maintain the testing results of every registered controlled goods. The testing results may be of help to determine whether the fault occurring in an incident or accident is attributed to a single product or a single batch.

APPENDICES

SINGAPORE CONSUMER PROTECTION (SAFETY REQUIREMENTS) REGISTRATION SCHEME

Appendix A

DEFINITIONS

- 1 **CAB** means Conformity Assessment Body that conducts Conformity assessment for Controlled Goods.
- 2 **CAB (Local)** means CAB that is located in Singapore and is designated by SPRING Singapore, the Designating Authority to issue COC for products or controlled goods supplied in Singapore specified in the First Schedule to the Consumer Protection (Safety Requirements) Regulations 2002.
- 3 **CAB (Foreign - MRA)** means CAB that is located in the MRA partner country and is designated by the Designating Authority of the MRA partner to issue COC.
- 4 **COC** means Certificate of Conformity issued by either CAB (Local) or CAB (Foreign-MRA).
- 5 **Controlled goods** means any goods of a type, class or description specified in the First Schedule of the Consumer Protection (Safety Requirements) Regulations 2002.
- 6 **MRA** means a Mutual Recognition Agreement or Arrangement between Singapore and any other country/customs territory.
- 7 **RTL** means a Recognised Testing Laboratory referred to in Part V of the Singapore Productivity and Standards Board (Conformity Assessment) Regulations 2002.
- 8 **registered controlled goods** means any controlled goods registered with the Safety Authority under Regulation 7 of the of the Consumer Protection (Safety Requirements) Regulations 2002.
- 9 **Safety Authority** means the Standards, Productivity and Innovation Board (formerly known as Singapore Productivity and Standards Board or SPRING Singapore) established under Section 3 of the Singapore Productivity and Standards Board Act (Chapter 303A).
- 10 **SAFETY Mark** means the SAFETY Mark specified in the Second Schedule of the Consumer Protection (Safety Requirements) Regulations 2002.
- 11 **IEC** means the International Electrotechnical Commission.
- 12 **SS** means Singapore Standard.

SINGAPORE CONSUMER PROTECTION (SAFETY REQUIREMENTS)
REGISTRATION SCHEME

Appendix B

FLOW-CHART FOR REGISTRATION OF SUPPLIER OF CONTROLLED GOODS

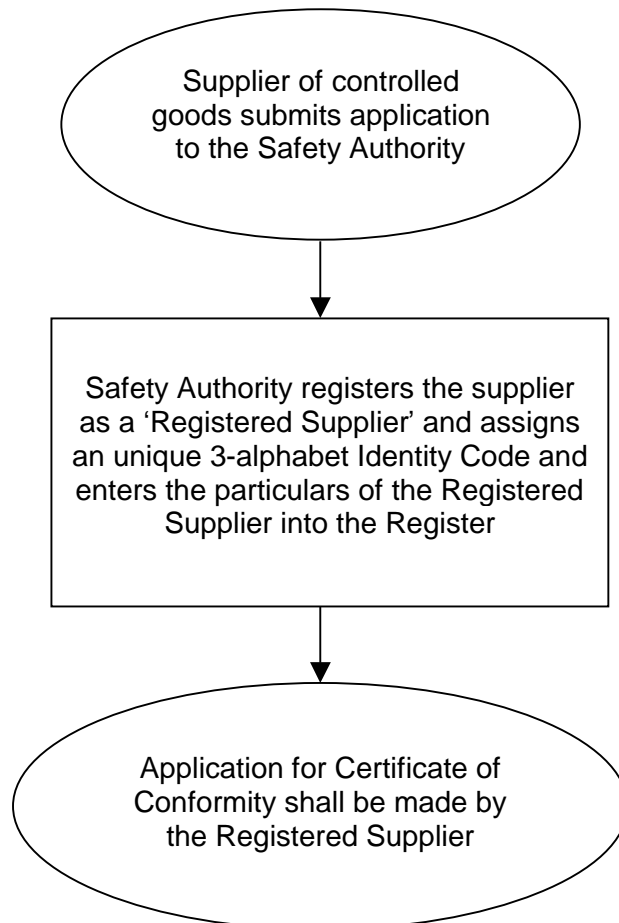

SINGAPORE CONSUMER PROTECTION (SAFETY REQUIREMENTS)
REGISTRATION SCHEME

Appendix C

FLOW-CHART FOR REGISTRATION OF CONTROLLED GOODS

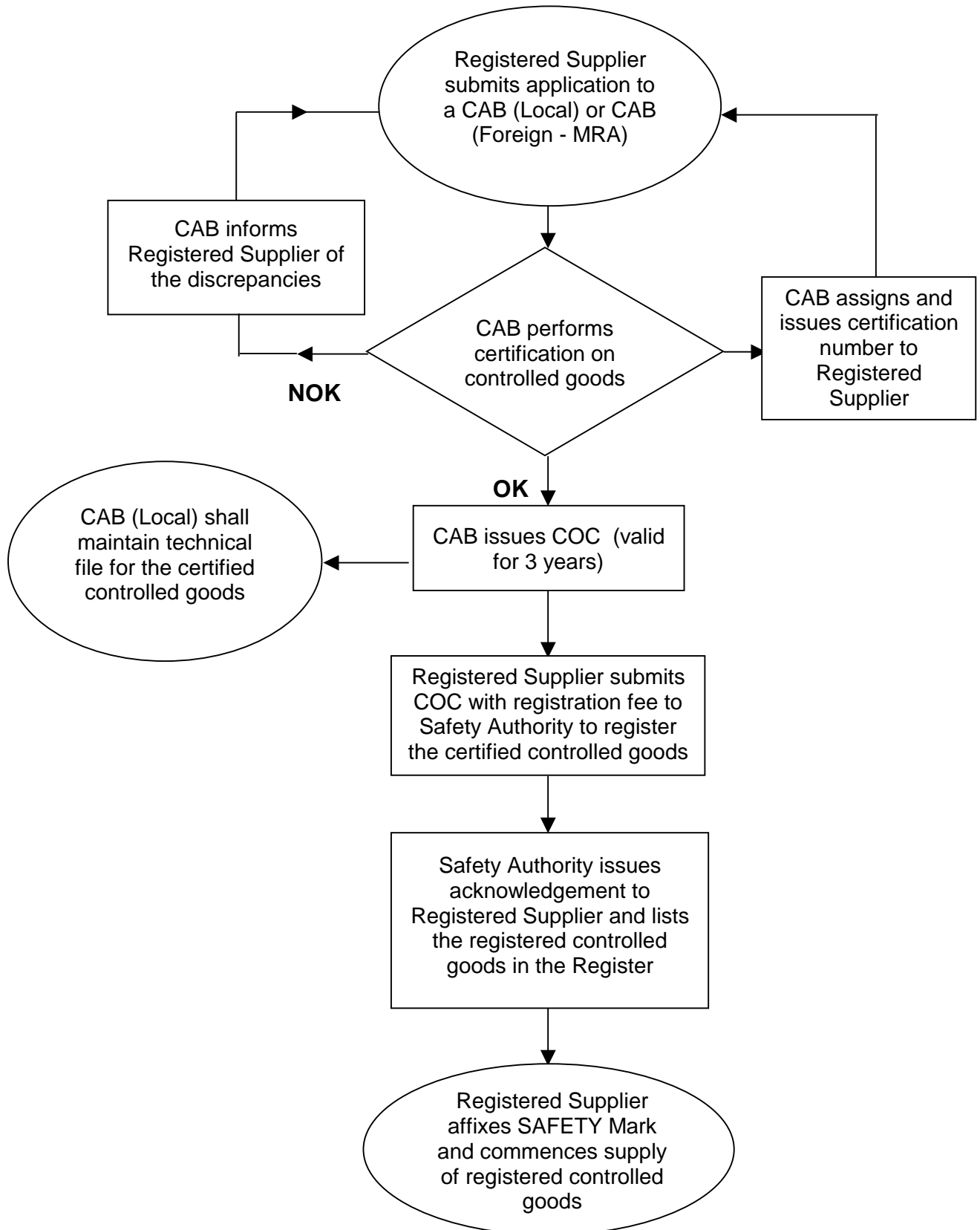

SINGAPORE CONSUMER PROTECTION (SAFETY REQUIREMENTS)
REGISTRATION SCHEME

Appendix D

FLOW-CHART FOR RENEWAL OF REGISTERED CONTROLLED GOODS

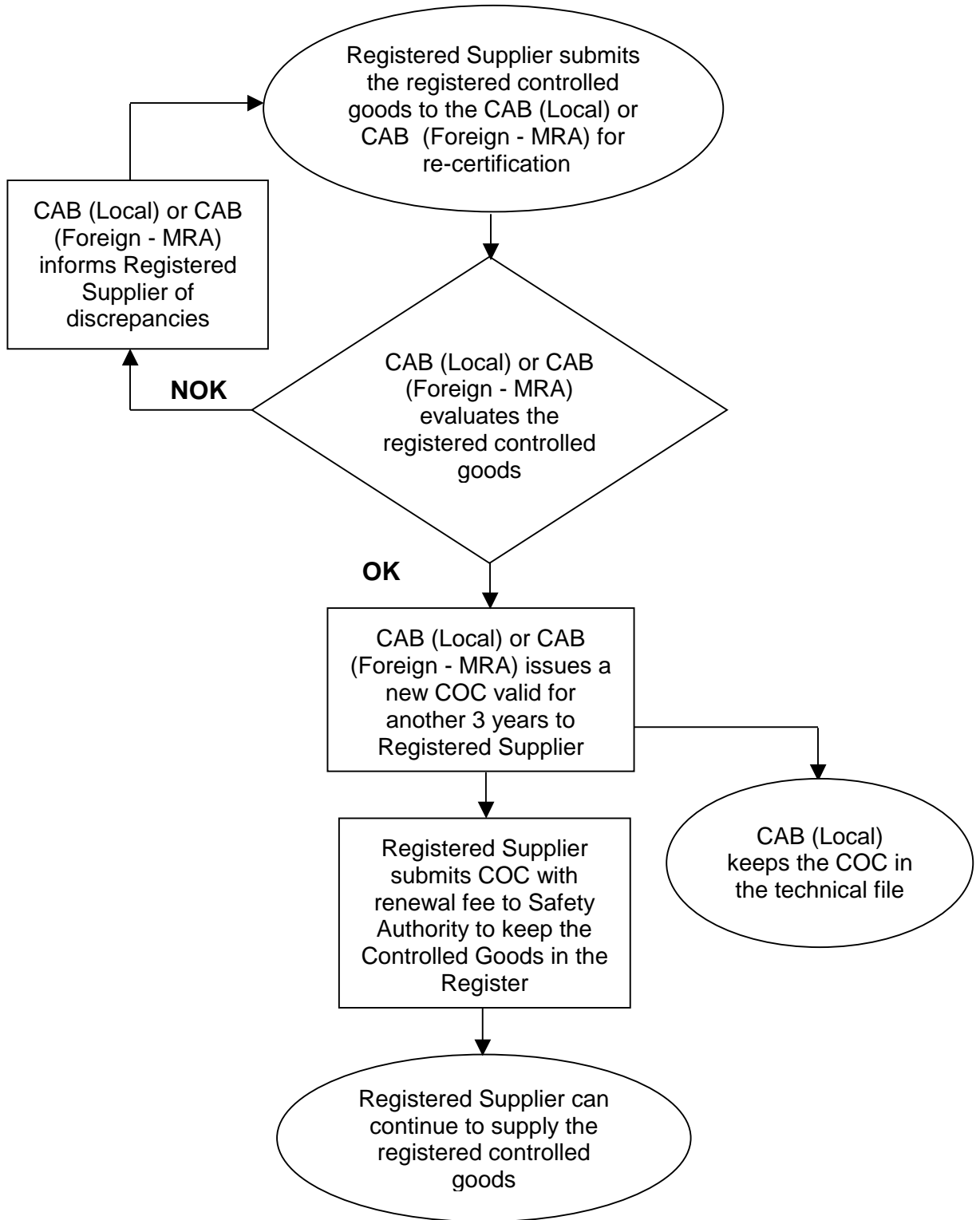

SINGAPORE CONSUMER PROTECTION (SAFETY REQUIREMENTS)
REGISTRATION SCHEME

Appendix E

FLOW-CHART FOR THE OVERALL VIEW OF REGISTRATION PROCESS

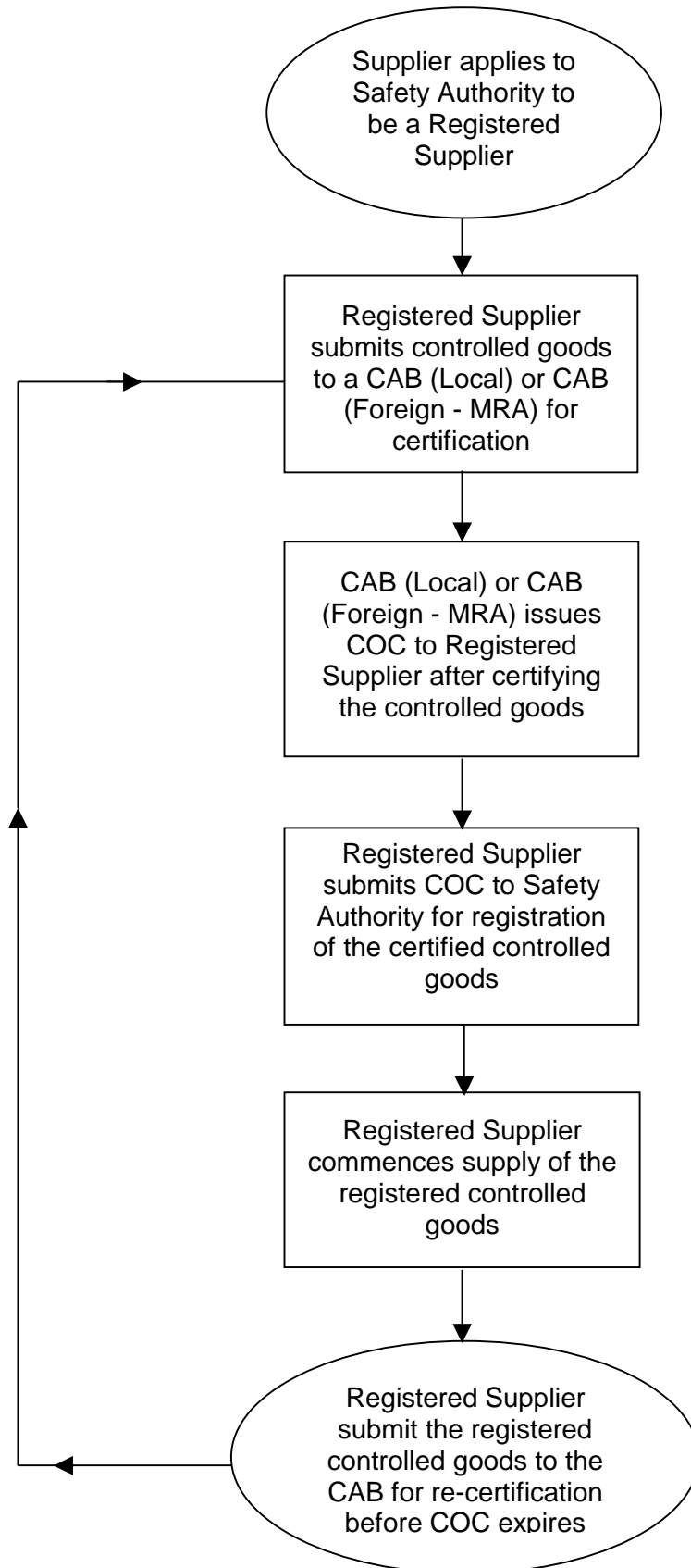

**SINGAPORE CONSUMER PROTECTION (SAFETY REQUIREMENTS)
REGISTRATION SCHEME**

Appendix F

FORM RS01 version 02	SINGAPORE CONSUMER PROTECTION (SAFETY REQUIREMENTS) REGISTRATION SCHEME Safety Authority, SPRING Singapore, 2 Bukit Merah Central, Podium Block, 5 th Storey, Singapore 159835									
APPLICATION FOR REGISTRATION OF SUPPLIER OF CONTROLLED GOODS										
1	Supplier's FULL Business Name: _____ _____	For Official Use Received on: 								
2	Supplier's FULL Registered Address in Singapore: _____ _____ _____ Postal Code: _____									
3	Supplier's Business Registration Number (issued by RCB) in Singapore: _____ (attach a copy of the Certificate of Incorporation of Private Company)	Registered Supplier's Allocated Submitter Code: 								
4	Types of Controlled Goods to supply in Singapore: _____ _____	<input type="checkbox"/> <input type="checkbox"/> <input type="checkbox"/>								
5	Name and Title of Person authorised to represent the above Supplier (must be a staff of Supplier): Dr/Mr/Ms: _____ Title: _____ Tel no. : _____ DID: _____ Fax no.: _____ Email: _____									
<table style="width:100%; border: none;"> <tr> <td style="width:50%; border: none;">_____</td> <td style="width:50%; border: none;">_____</td> </tr> <tr> <td style="border: none;">Authorised Signature</td> <td style="border: none;">Company's Registered Seal/Stamp</td> </tr> <tr> <td style="border: none;">_____</td> <td style="border: none;">_____</td> </tr> <tr> <td style="border: none;">Name and Title of Signatory</td> <td style="border: none;">Date</td> </tr> </table>			_____	_____	Authorised Signature	Company's Registered Seal/Stamp	_____	_____	Name and Title of Signatory	Date
_____	_____									
Authorised Signature	Company's Registered Seal/Stamp									
_____	_____									
Name and Title of Signatory	Date									
Knowingly Making A False Statement On This Application Is An Offence Under the Singapore Consumer Protection (Trade Descriptions and Safety Requirements) Act (Chapter 53)										

**SINGAPORE CONSUMER PROTECTION (SAFETY REQUIREMENTS)
REGISTRATION SCHEME**

Appendix G

GUIDELINES FOR COMPLETING FORM RS01

- 1 **Supplier's FULL Business Name**
Name of the company registered in Singapore with the Registry of Companies and Businesses (RCB) applying as a "Registered Supplier".

 - 2 **Supplier's FULL Registered Address in Singapore**
Registered address of the company registered with the RCB.

 - 3 **Supplier's Business Registration Number (issued by RCB) in Singapore**
Business registration number of the company issued by RCB.

 - 4 **Types of Controlled Goods intended to supply in Singapore**
Controlled goods that the supplier wishes to sell in the Singapore domestic market.

 - 5 **Name and Title of Person authorised to represent the above Supplier (must be a staff of Supplier)**
Name and title (designation) of person appointed by the company to be in-charge of submission of Certificate of Conformity (COC) as well as to liaise with the Safety Authority.
- Authorised Signature**
The signature of the staff authorised by the company to be responsible for the registration of controlled goods.
- Name and Title of Signatory**
The name and title (designation) of the staff authorised by the company to be responsible for registration of controlled goods.
- Company's Registered Seal/Stamp**
The registered seal or rubber-stamp of the company.
- Date**
The date of the day that FORM RS01 is signed.

**SINGAPORE CONSUMER PROTECTION (SAFETY REQUIREMENTS)
REGISTRATION SCHEME**

Appendix H

FORM RS02 version 02	SINGAPORE CONSUMER PROTECTION (SAFETY REQUIREMENTS) REGISTRATION SCHEME Safety Authority, SPRING Singapore, 2 Bukit Merah Central, Podium Block, 5 th Storey, Singapore 159835	
NOTIFICATION OF CHANGE OF REGISTERED SUPPLIER'S PARTICULARS		
<p>To: Safety Authority</p> <p>We wish to inform you that our company:</p> <p>_____</p> <p>has changed the following particulars:</p> <p>a) Company's Name:</p> <p>_____</p> <p style="text-align: center;">(must be attached with Certificate of Incorporation on Change of Company Name)</p> <p>b) Company's Registered Address:</p> <p>_____</p> <p>c) Name and Title of Person Authorised to Represent the Company:</p> <p>_____</p> <p>d) Telephone Number:</p> <p>_____</p> <p>e) Facsimile Number:</p> <p>_____</p> <p>f) Email Address:</p> <p>_____</p> <p>g) Others:</p> <p>_____</p>		
<p>_____</p> <p>Authorised Signature and Date</p> <p>_____</p> <p>Name and Title of Signatory</p>		

**SINGAPORE CONSUMER PROTECTION (SAFETY REQUIREMENTS)
REGISTRATION SCHEME**

Appendix I

FORM RS03 version 02	SINGAPORE CONSUMER PROTECTION (SAFETY REQUIREMENTS) REGISTRATION SCHEME Safety Authority, SPRING Singapore, 2 Bukit Merah Central, Podium Block, 5 th Storey, Singapore 159835	
DESCRIPTION OF MODIFICATION (for non-technical modification only)		
<p>To: Safety Authority</p> <p>We wish to inform the Safety Authority that our registered Controlled Goods,</p> <p>Trade Name: _____</p> <p>Model Number: _____</p> <p>Certificate of Conformity, number: _____</p> <p>has changed its registered model number to: _____</p> <p>due to the following modification(s):</p> <p style="text-align: center;">(Please describe the modification(s) in the box below)</p> <div style="border: 1px solid black; height: 150px; margin-top: 10px;"></div>		
<i>Note: A new certification number will be issued to the new model number should the modification(s) be accepted.</i>		
<p>_____</p> <p>Authorised Signature and Date</p> <p>_____</p> <p>Name and Title of Signatory</p>		

EXAMPLES OF NON-CONTROLLED GOODS

Below are some examples of products that are currently not in the list of controlled goods and therefore are deemed as non-controlled goods under the Consumer Protection (Safety Requirements) Regulations 2002. However, these non-controlled goods may be controlled under other scheme of other regulatory authorities. The products listed here are meant for reference purpose only. It does not mean that they cannot be included as controlled goods in the future. The detailed definitions of controlled goods are stated in the Consumer Protection (Safety Requirements) Regulations 2002.

Meanwhile, the onus of ensuring that the products and their accessories are safe rest with you and this advice is given without prejudice to any amendments to the Consumer Protection Act, its Regulations or the List of Controlled Goods.

- Air cleaner / Air purifier
- Bread maker
- Battery charger
- Camping gas stove/non re-usable gas canister
- Can opener
- Car audio
- Car vacuum cleaner / Centrally operated vacuum cleaner system
- Coffee grinder
- Commercial LPG system
- Cloth steamer / facial steamer
- Chest freezer / Wine cooler
- Components used in PCs
- Dishwasher / Tumbler dryer
- DC operated vacuum cleaner
- Energy saving device
- Electric ice crusher
- Electronic disinfectant
- Electronic type-writer
- Electronic wall-switch
- Fax machine / Photocopy machine (not link to personal computer)
- Hand-dryer / hair steamer / hair curler / hair styler
- Induction cooker / Solar cooker (using high intensity light bulbs)
- Juke box
- LPG barbeque grill
- Massage chair (mains operated)
- Misting Fog Fan / Ventilation fan
- Night light
- Portable television running on battery supply only. (e.g. car battery)
- Pressure cooker
- Steam steriliser
- Security alarm system
- Soyabean milk maker (using soyabean)
- Split system air-conditioner (fixed) /Electric dehumidifier/Humidifier
- Uninterrupted power supply (UPS)
- Vending machine
- Video cassette rewinder
- Water distiller

**SINGAPORE CONSUMER PROTECTION (SAFETY REQUIREMENTS)
REGISTRATION SCHEME**

Appendix K

**THE SINGAPORE CONSUMER PROTECTION
(SAFETY REQUIREMENTS) REGISTRATION SCHEME**



Certificate of Conformity (COC)

CAB (Local)'s or CAB (Foreign - MRA)'s Letter Head

To: RS Identity Code
Registered Supplier

Date of Certification : _____

Date of Expiry : _____

Certificate Number : _____

Dear Sir/Madam,

We certify that the following controlled goods complied with the Mandatory Requirements of the Singapore Consumer Protection (Safety Requirements) Registration Scheme:

Description of controlled goods: _____

Trade Name: _____

Model Number: _____

Country where controlled goods are likely to be manufactured: _____

Test report number: _____

Testing laboratory: _____

Tested according to: _____

CAB
Certifying Officer

Important Notice:

No controlled goods can be supplied in Singapore unless they are registered with the Safety Authority. Please access www.safety.org.sg for registration procedure.

**SINGAPORE CONSUMER PROTECTION (SAFETY REQUIREMENTS)
REGISTRATION SCHEME**

Appendix L

**THE SINGAPORE CONSUMER PROTECTION
(SAFETY REQUIREMENTS) REGISTRATION SCHEME**



Certificate of Conformity (COC)

CAB (Local)'s or CAB (Foreign - MRA)'s Letter Head

To: **ABC
Mr Kingsman Lee
Worldwide Electrical Trading (S) Pte Ltd
8 Kaki Bukit Avenue 1
Worldwide Building
Singapore 232865**

Date of Certification : 2 April 2002

Date of Expiry : 1 April 2005

Certificate Number : 123456-11

Dear Sir/Madam,

We certify that the following controlled goods complied with the Mandatory Requirements of the Singapore Consumer Protection (Safety Requirements) Registration Scheme:

Description of controlled goods: Top-loading Washing Machine rated 220-240 VAC, 50 Hz,
2300 W, 5 Kg, Class I

Trade Name: TECTRONIC

Model Number: EWM-5005SS

Country where controlled goods are likely to be manufactured: China

Test report number: 2002-10001-32

Testing laboratory: Bonsia Testing Services Ltd

Tested according to: IEC 60335-2-7: 1993

CAB
Certifying Officer

Important Notice:

No controlled goods can be supplied in Singapore unless they are registered with the Safety Authority. Please access www.safety.org.sg for registration procedure.

SINGAPORE CONSUMER PROTECTION (SAFETY REQUIREMENTS)
REGISTRATION SCHEME

Appendix M

**THE SINGAPORE CONSUMER PROTECTION
(SAFETY REQUIREMENTS) REGISTRATION SCHEME**



Acknowledgement Receipt for Certificate of Conformity

SAFETY AUTHORITY

To: Registered Supplier

Dear Sir/Madam,

We acknowledge receipt of Certificate of Conformity,

Certificate Number: _____,

for registration of controlled goods, _____,

Trade Name: _____,

Model Number: _____,

and would like to confirm that the controlled goods are entered into the Register of Registered Controlled Goods, pursuant to the Consumer Protection (Safety Requirements) Regulations 2002.

*Registration Officer
for Safety Authority*

**GUIDELINES FOR USING SAFETY MARK ON THE REGISTERED
CONTROLLED GOODS**

The SAFETY Mark comprises of a safety logo enclosed in a square on the left and the word “SAFETY MARK” enclosed in a rectangle on the right. Below the logo is an unique certification number traceable to the registrant. The colour used is Pantone 287C Blue Colour



X X Y Y Y Y – Z Z

**1 SAFETY Mark without Contrasting Background
(e.g. embossed on body of controlled goods)**

The safety logo, letters and certification number shall be of raised or lowered depth of not less than 0.51 mm.

The SAFETY Mark (consisting of both the safety logo and the word “SAFETY MARK”) shall have a height of not less than 9.5 mm. The certification number shall have a height of not less than 2.8 mm.

Any SAFETY Mark with dimension smaller than the above has to be approved by the Safety Authority.

**2 SAFETY Mark with Contrasting Background
(e.g. silk screened on body of controlled goods or printed on rating labels or carton boxes or as standalone adhesive labels)**

The SAFETY Mark (consisting of both the safety logo and the word “SAFETY MARK”) shall have a height of not less than 6.0 mm. The certification number shall have a height of not less than 1.6 mm.

Any SAFETY Mark with dimension smaller than the above has to be approved by the Safety Authority.

3 Points for adherence

- a) The SAFETY Mark shall be fully reproduced with the safety logo enclosed in a square on the left, the word “SAFETY MARK” enclosed in a rectangle on the right and the certification number traceable to the registrant across the bottom.

**SINGAPORE CONSUMER PROTECTION (SAFETY REQUIREMENTS)
REGISTRATION SCHEME**

Appendix N

**GUIDELINES FOR USING SAFETY MARK ON THE REGISTERED
CONTROLLED GOODS**

- b) The SAFETY Mark can be embossed or silk screened on any coloured material or printed with the same colour used for rating labels or carton box markings. When printed as standalone adhesive labels, the colour of the safety logo, the background for the word “SAFETY MARK” and the certification number is Pantone 287C Blue Colour.
- c) The SAFETY Mark shall be easily discernible on the controlled goods.
- d) The SAFETY Mark shall be indelible and legible. The marking shall not be removed when rubbed lightly with a piece of cloth soaked with petroleum, spirit or water.
- e) Rating labels or standalone adhesive labels with the SAFETY Mark shall not come loose or curled at the edges.
- f) Please refer to the bromide provided by the Safety Authority for size relationship between the safety logo and the word “SAFETY MARK”. They could be enlarged or reduced proportionately and still meet the size requirements stipulated in point (1) and (2), depending on whether the background is non-contrasting or contrasting.

Compliance is checked by visual inspection as well as the test mentioned in above paragraph (d)

4 SAFETY Mark on AC Adaptors

For **AC Adaptors** (to be used with other products), registration is granted for the adaptors only and does not cover the other products. Therefore, only the adaptors should be affixed with the SAFETY Mark.

However, if the packaging containing both the AC Adaptors and other products is to be affixed with the SAFETY Mark, then the statement “**This SAFETY Mark applies to the AC Adaptor only**” has to be printed near the SAFETY Mark.

5 SAFETY Mark on 3-Pin Mains Plugs

For **3-pin mains plug** (13 and 15 Amperes), the SAFETY Mark must carry the statement ‘**for mains plug**’ below the certification number.



X X Y Y Y Y – Z Z
(for mains plug)

**GUIDELINES FOR USING SAFETY MARK ON THE REGISTERED
CONTROLLED GOODS**

6 SAFETY Mark on 3-Pin Portable Socket-Outlet and Portable Cable Reel

For **3-pin portable socket-outlet** and **portable cable reel**, the SAFETY Mark must carry the statement 'for 3-pin portable socket-outlet' or "for portable cable reel" respectively below the certification number.



X X Y Y Y Y – Z Z
(for 3-pin portable socket-outlet)



X X Y Y Y Y – Z Z
(for portable cable reel)

7 Ordering of Bromide of the SAFETY Mark

To assist Registered Suppliers in production of the SAFETY Mark, we have bromide (camera ready logo) available for sale at \$6. To place order, please call our administration section for arrangement at Tel: 6 279 1834 or 6 279 1835 or Fax: 6 278 9885 or Email: enquiry@safety.org.sg.

**SINGAPORE CONSUMER PROTECTION (SAFETY REQUIREMENTS)
REGISTRATION SCHEME**

Appendix O

**GUIDELINES FOR USING SAFETY MARK IN ADVERTISEMENTS OR
PUBLICITY MATERIALS**

- 1 The SAFETY Mark shall be used for products registered under the Consumer Protection (Safety Requirements) Registration Scheme.
- 2 The SAFETY Mark is only complete with the respective certification number. When used in advertisements, the SAFETY Mark with the certification number for each registered model should be used if there is more than one model advertised. If there is a space constraint, a single SAFETY Mark may be used.
- 3 The following statement may be used with the SAFETY Mark:
 - a) “The product (state the name and model no.) has been type-tested and considered to be in compliance with the safety requirements of the Standard (state the standard) and hence registered and entered into the Register of Registered Controlled Goods, (under pursuant to) the Consumer Protection (Safety Requirements) Regulations 2002. The registration is NOT an endorsement of the quality control system of the manufacturing process”.
 - b) “Look for the SAFETY Mark”
 - c) “Insist on the SAFETY Mark”
 - d) “Safe Home With The SAFETY Mark”.
- 4 Statements like “PSB-tested safe for use” or “PSB certified” should NOT be used. This is because the scheme only requires one sample of the said model to be type-tested. Use of the above statements will be misleading.
- 5 Any statement referring to the Consumer Protection (Safety Requirements) Registration Scheme or the SAFETY Mark, other than those stated in Paragraph 3 above should be sent to SPRING Singapore, Safety Authority, Consumer Product Safety Department (CPSD) for vetting before publication. Please Fax to 6 278 9885 or contact CPSD at DID 6 279 1834 / 6 279 1835.

SINGAPORE CONSUMER PROTECTION (SAFETY REQUIREMENTS)
REGISTRATION SCHEME

Appendix O

EXAMPLE

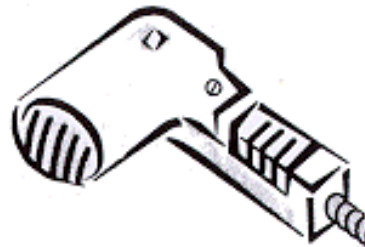
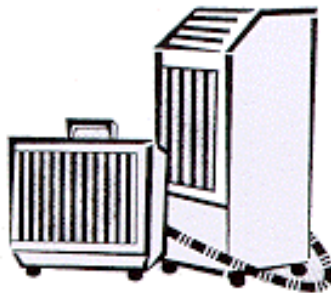
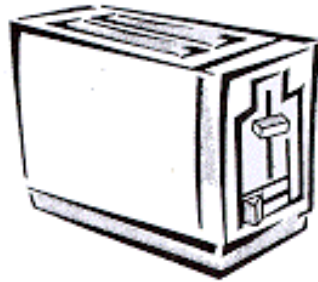
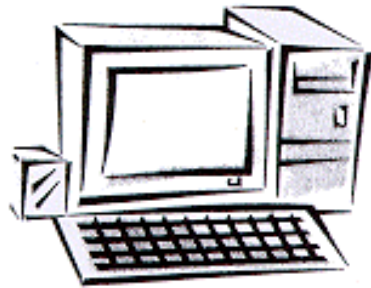

Safe Home with The SAFETY Mark



1 2 3 4 5 6 - 0 0

**SINGAPORE CONSUMER PROTECTION (SAFETY REQUIREMENTS)
REGISTRATION SCHEME**

Appendix P

CONFORMITY ASSESSMENT BODIES (LOCAL)

I) Certification Body – For Product Certification and issuing of Certificate of Conformity (COC)

No	Date of Designation	Name of Certification Body	Address & Contact person	Able to issue COC for the following Controlled Goods	
1a	16 April 2002	PSB Corporation Pte Ltd (Certification and Inspection)	<p>Contact person: (1) Mr Paul Tan Assistant Vice President (2) Mr Christopher Hee Senior Engineer</p> <p>No. 1 Science Park Drive Annex Building Singapore 118221</p> <p>Tel no: 6 885 1270 / 6 885 1271 Fax no: 6 775 9725 Email: enquiries@psbcorp.com</p> <p>Website: www.psbcorp.com</p>	1	Vacuum Cleaner
				2	Iron
				3	Cooking range
				4	Toaster, grill, oven and similar appliances <ul style="list-style-type: none"> • Hot Plate and similar appliances • Deep fryer, electric wok and similar appliances
				5	Washing Machine
				6	Mixer, blender, mincer and similar appliances
				7	Rice cooker
				8	Kettle
				9	Coffee maker, slow cooker, steamboat and similar appliances
				10	Mobile split air conditioner
				11	Room air conditioner
				12	Table or standing fan
				13a	Wall fan
				13b	Ceiling fan
				14	Home computer system (inclusive of monitor, printer, speaker and other mains operated accessories)
				15	Adaptor <ul style="list-style-type: none"> • for computer / telephonic appliances • for electrical appliances • for electronic appliances
				16	Television / Video Display unit
				17	High Fidelity set
				18	Laser disc set
				19	Video cassette recorder
				20	Any other audio products
				21	Hair Dryer
				22	Refrigerators
23	Microwave Oven				
1b	21 January 2003			24	Air Cooler
				25	Immersion water heater
				26	Decorative lighting fixture
				27	Table lamp / Standing lamp
				28	3-pin rectangular type 13-Amp plug
				29	Fuse (\leq 13 amperes) for use in plug
				30	Portable cable reel
				31	Instantaneous electric water heater
				32	Mains pressure electric storage water heater
				33	Multi-way Adaptor
				34	3-pin portable socket-outlet

**SINGAPORE CONSUMER PROTECTION (SAFETY REQUIREMENTS)
REGISTRATION SCHEME**

Appendix P

CONFORMITY ASSESSMENT BODIES (LOCAL)

II) Certification Body – For Product Certification and issuing of Certificate of Conformity (COC)

No	Date of Designation	Name of Certification Body	Address & Contact person	Able to issue COC for the following Controlled Goods	
1c	30 July 2003			35	3-pin round type 15A plug
				36	Residual Current Circuit Breaker (RCCB)
				37	3-pin 13-amp Socket-Outlet
				38	3-pin round type 15-amp Socket-Outlet
				39	Domestic electric wall switch
				40	Ballast for tubular fluorescent lamp
				41	Isolating transformer for downlight fitting (including electronic isolating transformer)
				42	Gas canister
				43	Gas cooker
				44	Portable cooking gas appliances
				45a	Components of LPG gas system – Regulator
				45b	Components of LPG gas system – Valve

Note: The list will be updated from time to time and is available on the website: www.safety.org.sg

**SINGAPORE CONSUMER PROTECTION (SAFETY REQUIREMENTS)
REGISTRATION SCHEME**

Appendix P

CONFORMITY ASSESSMENT BODIES (LOCAL)

III) Testing Laboratories – For Product Testing and issuing of test report

No	Date of Designation	Name of Certification Body	Address & Contact person	Able to issue COC for the following Controlled Goods	
2a	21 January 2003	PSB Corporation Pte Ltd (Electrical and Electronic Testing Laboratory)	For item 1 to 41, Contact person: (1) Mr Tan Lee Heng Assistant Vice President (2) Mr Yap Liep Lin Assistant Vice President No. 1 Science Park Drive Annex Building Singapore 118221 Tel no: 6 885 1350 / 6 885 1366 Fax no: 6 774 5705 / 6774 6119 Email: enquiries@psbcorp.com Website: www.psbcorp.com	1	Vacuum Cleaner
				2	Iron
				3	Cooking range
				4	Toaster, grill, oven and similar appliances • Hot Plate and similar appliances • Deep fryer, electric wok and similar appliances
				5	Washing Machine
				6	Mixer, blender, mincer and similar appliances
				7	Rice cooker
				8	Kettle
				9	Coffee maker, slow cooker, steamboat and similar appliances
				10	Mobile split air conditioner
				11	Room air conditioner
				12	Table or standing fan
				13a	Wall fan
				13b	Ceiling fan
				14	Home computer system (inclusive of monitor, printer, speaker and other mains operated accessories)
				15	Adaptor • for computer / telephonic appliances • for electrical appliances • for electronic appliances
				16	Television / Video Display unit
				17	High Fidelity set
				18	Laser disc set
				19	Video cassette recorder
				20	Any other audio products
				21	Hair Dryer
				22	Refrigerators
				23	Microwave Oven
				24	Air Cooler
				25	Immersion water heater
				26	Decorative lighting fixture
				27	Table lamp / Standing lamp
				28	3-pin rectangular type 13-Amp plug
				29	Fuse (\leq 13 amperes) for use in plug
				30	Portable cable reel
				31	Instantaneous electric water heater
				32	Mains pressure electric storage water heater
				33	Multi-way Adaptor
				34	3-pin portable socket-outlet
35	3-pin round type 15A plug				
2b	25 May 2003			36	Residual Current Circuit Breaker (RCCB)

**SINGAPORE CONSUMER PROTECTION (SAFETY REQUIREMENTS)
REGISTRATION SCHEME**

No	Date of Designation	Name of Certification Body	Address & Contact person	Able to issue COC for the following Controlled Goods	
				37	3-pin 13-amp Socket-Outlet
				38	3-pin round type 15-amp Socket-Outlet
				39	Domestic electric wall switch
				40	Ballast for tubular fluorescent lamp
				41	Isolating transformer for downlight fitting (including electronic isolating transformer)
2c	26 March 2003	PSB Corporation Pte Ltd (Mechanical)	For item 42 to 45, Contact person: Mr Seah Chong An / Mr Chan Chiu Seng Assistant Vice President / Senior Engineer Mechanical Testing Centre (MEC) No. 1 Science Park Drive Singapore 118221 Tel no: 6 885 1413 / 6 885 1412 Fax no: 6 779 9303 Email: chong-an.seah@psbcorp.com / chiu-seng.chan@psbcorp.com	42	Gas canister
				43	Gas cooker
				44	Portable cooking gas appliances
				45a	Components of LPG gas system – Regulator
				45b	Components of LPG gas system – Valve

Note: The list will be updated from time to time and is available on the website: www.safety.org.sg

**SINGAPORE CONSUMER PROTECTION (SAFETY REQUIREMENTS)
REGISTRATION SCHEME**

Appendix Q

CONFORMITY ASSESSMENT BODIES (FOREIGN- MRA)

I) Certification Bodies – For Product Certification and issuing of Certificate of Conformity (COC)

No	Country	Name of CAB	Address	Scope of Testing
pending designation				

Note: The list will be updated from time to time and is available on the website: www.safety.org.sg

II) Testing Laboratories - For Product Testing and issuing of test report

No	Date of Designation	Country	Name of Testing Laboratory	Address	Able to test the following Controlled Goods	
1	14 June 2001	New Zealand	Parkside Laboratories Ltd	Contact person: Mr Manuel Shimasaki Managing Director 58 Hazeldean Road P O Box 9194, Christchurch, New Zealand Tel: +64-3-339 1670 Fax: +64-3-339 1671 Email: enquiries@parksidelabs.com Website: www.parksidelabs.com	1	Air cooler
					2	Adaptor
					3	Any other audio products
					4	Cooking range
					5	Coffee maker, slow cooker, steam boat and similar appliances
					6	Decorative lighting fixture
					7	Hair dryer
					8	Home computer system (inclusive of monitor, printer, speaker and other mains operated accessories)
					9	High-fidelity set
					10	Iron
					11	Immersion water heater
					12	Kettle
					13	Laser disc set
					14	Mobile split air-conditioner
					15	Mixer, blender, mincer and similar appliances
					16	Microwave oven
					17	Refrigerator
					17	Rice cooker
					18	Room air-conditioner
					19	Television / video display unit
					20	Table or standing fan
					21	Table lamp/ standing lamp
					22	Toaster, grill, roaster, hot plate, deep fryer, wok and similar appliances
					23	Video cassette recorder
					24	Vacuum cleaner
					25	Washing machine
26	Wall fan (exclude Ceiling fan)					

**SINGAPORE CONSUMER PROTECTION (SAFETY REQUIREMENTS)
REGISTRATION SCHEME**

Appendix Q

CONFORMITY ASSESSMENT BODIES (FOREIGN- MRA)

No	Date of Designation	Country	Name of Testing Laboratory	Address	Able to test the following Controlled Goods	
2	23 October 2001	New Zealand	Wakefield Laboratories Limited	Contact person: Mr Ken Wilson Technical Director 54 Tarndale Grove, P O Box 300 330, Albany 1331, Auckland, New Zealand Tel: +64-9-415 3355 Fax: +64-9-415 3356 Email: admin@wakelabs.co.nz	1	Air cooler
					2	Adaptor
					3	Any other audio products
					4	Cooking range
					5	Coffee maker, slow cooker, steam boat and similar appliances
					6	Decorative lighting fixture
					7	Hair dryer
					8	Home computer system (inclusive of monitor, printer, speaker and other mains operated accessories)
					9	High-fidelity set
					10	Iron
					11	Immersion water heater
					12	Kettle
					13	Laser disc set
					14	Mobile split air-conditioner
					15	Microwave oven
					16	Mixer, blender, mincer and similar appliances
					17	Refrigerator
					18	Rice cooker
					19	Room air-conditioner
					20	Television / video display unit
					21	Table or standing fan
					22	Table lamp/ standing lamp
					23	Toaster, grill, roaster, hot plate, deep fryer, wok and similar appliances
					24	Video cassette recorder
					25	Vacuum cleaner
					26	Washing machine
					27	Wall fan (exclude Ceiling fan)

Note: The list will be updated from time to time and is available on the website: www.safety.org.sg

**SINGAPORE CONSUMER PROTECTION (SAFETY REQUIREMENTS)
REGISTRATION SCHEME**

Appendix R

RECOGNISED TESTING LABORATORIES

RTL - For Product Testing and issuing of test report

No	Date of Designation	Country	Name of Testing Laboratory	Address & Contact person	Able to carry our product testing for the following Controlled Goods	
1	29 May 2002	Hong Kong	ETL SEMKO Division of Intertek Testing Services Hong Kong Ltd	Contact person: Mr Chapman Chan General Manager 2/F, Garment Centre 576 Castle Peak Road, Kowloon, Hong Kong Tel : (852) 21738559 / (852) 21738568 Fax: (852) 27855487 Website: www.etlsemko.com <i>Singapore Office contact:</i> Name : Mr HF Leong Tel : 6388 8666 Fax: 6382 6268 Email: hengfatt.leong@intertek.com	1	Iron
					2	Cooking range
					3	Washing Machine
					4	Toaster, grill, oven and similar appliances (excluding hot plate, deep fryer, electric wok and similar appliances)
					5	Mixer, blender, mincer and similar appliances
					6	Rice Cooker
					7	Kettle
					8	Coffee maker, slow cooker, steam boat and similar appliances
					9	Hair dryer
					10	Refrigerator
					11	Room air-conditioner
					12	Table or standing fan
					13	Wall fan (exclude Ceiling fan)
					14	Any other audio products
					15	High-Fidelity set
					16	Laser disc set
					17	Television / video display unit
					18	Video cassette recorder
					19a	Adaptor – for electronic appliances
					19b	Adaptor – for electrical appliances
					19c	Adaptor – for computer / telephonic appliances
					20	Home computer system (inclusive of monitor, printer, speaker and other mains operated accessories)
					21	Table lamp / standing lamp
					22	Decorative lighting fixture
					23	3-pin rectangular type 13-amp plug
24	Multiway Adaptor					
25	3-pin portable socket-outlet					

Note: The list will be updated from time to time and is available on the website: www.safety.org.sg

**SINGAPORE CONSUMER PROTECTION (SAFETY REQUIREMENTS)
REGISTRATION SCHEME**

Appendix R

RECOGNISED TESTING LABORATORIES

RTL - For Product Testing and issuing of test report

No	Date of Designation	Country	Name of Testing Laboratory	Address & Contact person	Able to carry our product testing for the following Controlled Goods	
2	30 August 2002 (for item 1 to 4) 17 July 2003 (for item 5 to 9)	Singapore	Singapore Electrical Testing Services (Clipsal Industries (Holdings) Limited)	Contact person: Mr Tan Boon Chong General Manager / Mr Wong Chee Kian Laboratory Manager 97 Pioneer Road Singapore 639579 Tel : (65) 6415 3274 / (65) 6861 9118 Fax: (65) 6863 2760 Email: BCTan@clipsal.com.sg / chee_kian@clipsal-tech.com.sg	1	3-pin rectangular type 13-amp plug
					2	3-pin round type 15-amp plug
					3	Multi-way Adaptor
					4	Portable cable reel
					5	Fuse (≤ 13-amp) for use in plug (except for clause 8.4 – Breaking capacity test)
					6	3-pin portable socket-outlet
					7	3-pin 13-amp socket-outlet
					8	3-pin round type 15-amp socket-outlet
					9	Domestic electric wall switch
3	28 October 2002	Taiwan R.O.C	TÜV Rheinland Taiwan Ltd	Contact person: Mr Jörg Rossow (Branch Manager) / Mr Willy Ong (Manager) 10F, No. 219, Min-Chuan Road, Taichung 403, Taiwan R.O.C Tel : 886-04-2301-9898 Fax: 886-04-2301-9696 Email: w@tw.tuv.com	1	Vacuum Cleaner
					2	Iron
					3	Table Lamp / Standing Lamp
					4	Washing Machine
					5	Toaster, grill, oven and similar appliances (excluding hot plate, deep fryer, electric wok and similar appliances)
					6	Mixer, blender, mincer and similar appliances
					7	Rice Cooker
					8	Kettle
					9	Coffee maker, slow cooker, steam boat and similar appliances
					10	Refrigerator
					11	Room air-conditioner
					12	Mobile split air-conditioner
					13	Table or standing fan
					14	Wall fan (exclude Ceiling fan)
					15	Air Cooler
					16	Any other audio products
					17	High-Fidelity set
					18	Laser disc set
					19	Television / video display unit
					20	Video cassette recorder
					21a	Adaptor – for electronic appliances
					21b	Adaptor – for electrical appliances
					21c	Adaptor – for computer / telephonic appliances
22	Home computer system (inclusive of monitor, printer, speaker and other mains operated accessories)					
23	Decorative lighting fixture					

**SINGAPORE CONSUMER PROTECTION (SAFETY REQUIREMENTS)
REGISTRATION SCHEME**

Appendix R

RECOGNISED TESTING LABORATORIES

RTL - For Product Testing and issuing of test report

No	Date of Designation	Country	Name of Testing Laboratory	Address & Contact person	Able to carry our product testing for the following Controlled Goods	
4	10 December 2002	Thailand	Intertek Testing Services (Thailand) Ltd – ETL SEMKO Division	Contact person: Ms Rungnapa Sombunsukho Division Manager, ETL SEMKO Division 5/1 Phaholyothin 28, Phaholyothin Road Lardyao, Chatuchak, Bangkok 10900 Thailand Tel : 662 939 0661 Fax: 662 513 2927 Email: rungnapas@itslabtest-bkk.com Website: www.etlsemko.com Singapore Office contact: Name : Mr HF Leong Tel : 6388 8666 Fax: 6382 6268 Email: hengfatt.leong@intertek.com	1	Coffee maker, slow cooker, steamboat and similar appliances
					2	Kettle
					3	Rice Cooker
					4	Table or standing fan
					5	Washing machine – Spin extractor
					6	Wall fan only
5	13 January 2003	Sweden	SEMKO AB	Contact person: Mr Jen Sjöberg Vice President Certification Services SEMKO AB PO Box 1103 Torshamnsgatan 43 SE 164 22 Kista Sweden Tel : 46 8 750 0000 Fax: 46 8 750 6030 Email: jens.sjoberg@semko.se Website: www.etlsemko.com Singapore Office contact: Name : Mr HF Leong Tel : 6388 8666 Fax: 6382 6268 Email: hengfatt.leong@intertek.com	1	Vacuum Cleaner
					2	Iron
					3	Cooking range
					4	Washing Machine
					5	Toaster, grill, roaster, hot plate, deep fryer, wok and similar appliances - for hot plate and similar appliances - for toaster, grill, oven and similar appliances - for deep fryer, electric wok and similar appliances
					6	Mixer, blender, mincer and similar appliances
					7	Rice Cooker
					8	Kettle
					9	Coffee maker, slow cooker, steam boat and similar appliances
					10	Hair dryer
					11	Refrigerator
					12	Microwave oven
					13	Mobile split air-conditioner
					14	Room air-conditioner
					15	Immersion water heater
					16	Table or standing fan
					17	Wall fan only
					18	Any other audio products

**SINGAPORE CONSUMER PROTECTION (SAFETY REQUIREMENTS)
REGISTRATION SCHEME**

Appendix R

No	Date of Designation	Country	Name of Testing Laboratory	Address & Contact person	Able to carry our product testing for the following Controlled Goods	
					19	High - Fidelity set
					20	Laser disc set
					21	Television / video display unit
					22	Video cassette recorder
					23a	Adaptor – for electronic appliances
					23b	Adaptor – for electrical appliances
					23c	Adaptor – for computer / telephonic appliances
					24	Home computer system (inclusive of monitor, printer, speaker and other mains operated accessories)
					25	Table lamp / standing lamp
					26	Decorative lighting fixture

Note: The list will be updated from time to time and is available on the website: www.safety.org.sg

**DRAWINGS SHOWING ACCEPTABLE AND NOT ACCEPTABLE FAN MOTOR
SHAFT FOR DECORATIVE CEILING FAN**

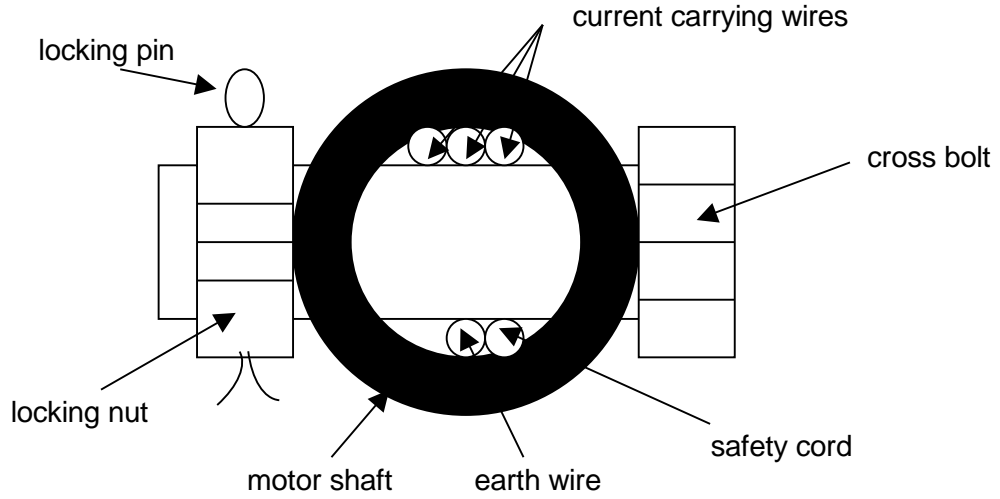

Figure A: Not Acceptable (wires under stress)

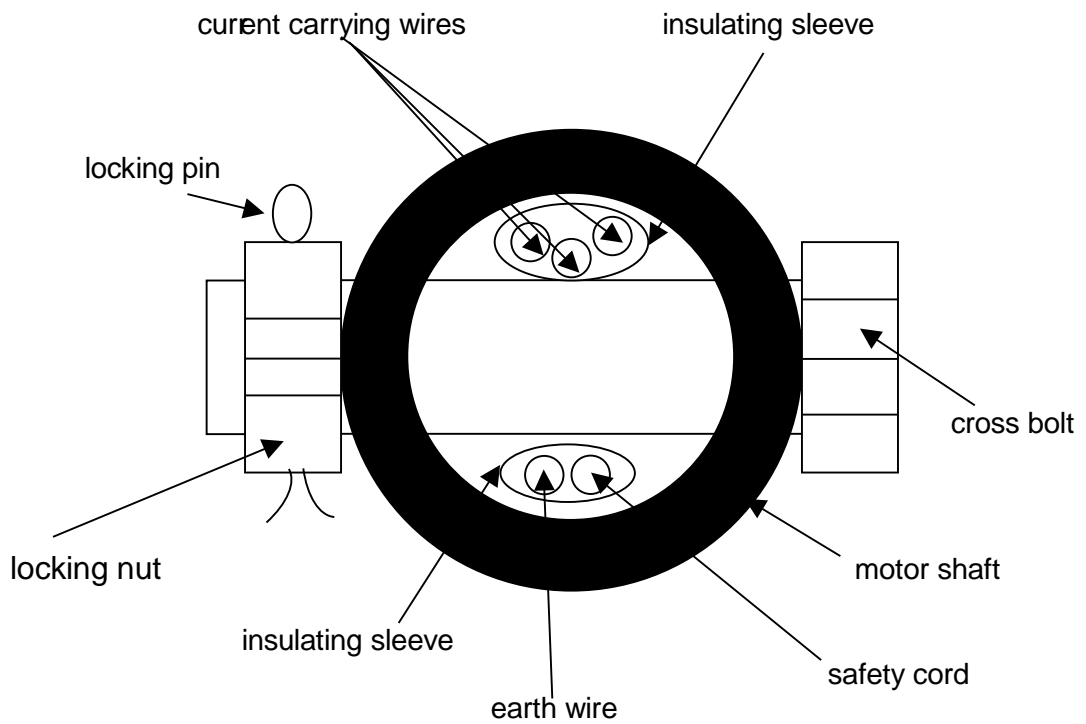
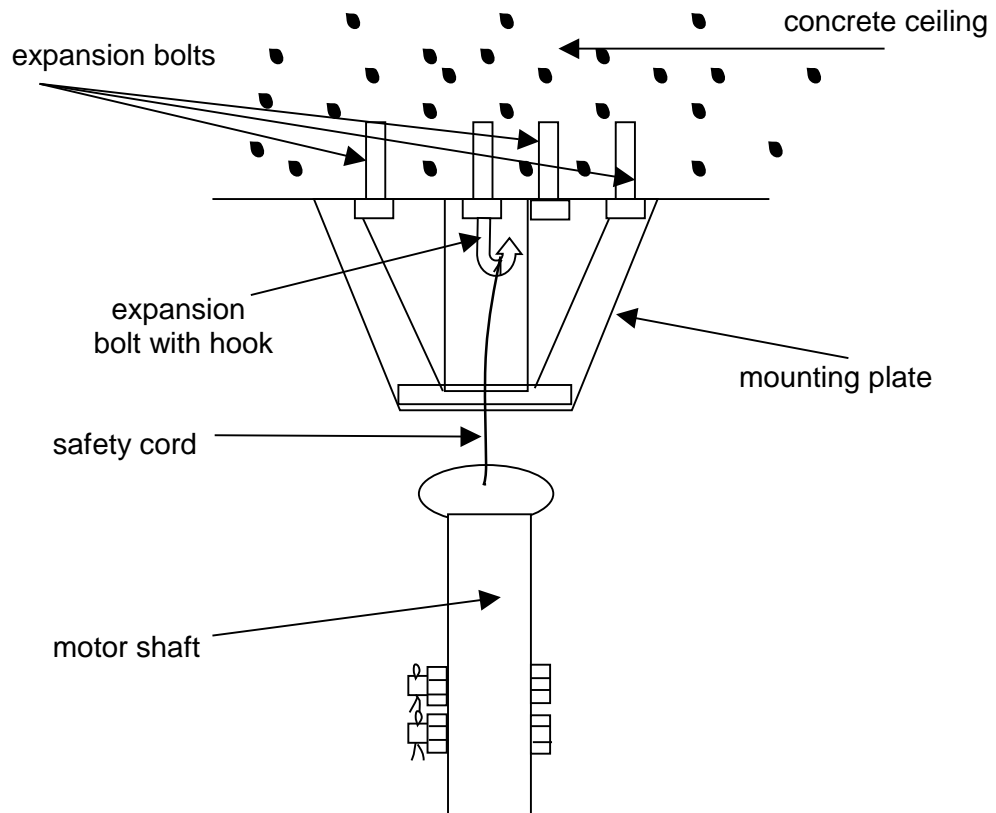

Figure B: Acceptable (wires not under stress)



DIAGRAM SHOWING THE 3 EXPANSION BOLTS, SAFETY CORD, EXPANSION BOLTS WITH HOOK AND MOUNTING PLATE OF CEILING FAN



**DRAWINGS SHOWING ACCEPTABLE AND NOT ACCEPTABLE DISTANCE
BETWEEN THE BOTTOM OF THE BURNER RING AND TIP OF THE GAS
INJECTOR**

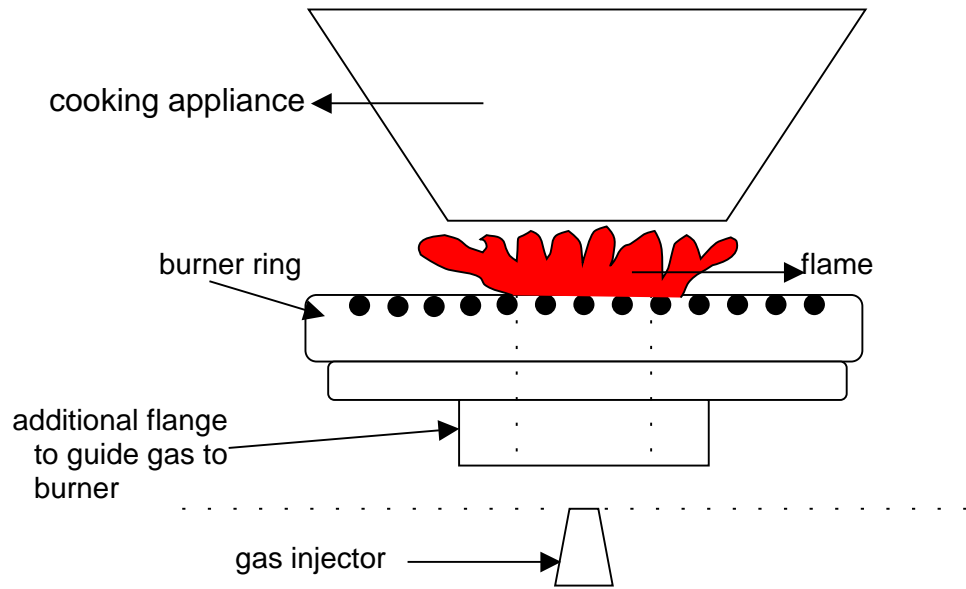

Figure A: Acceptable

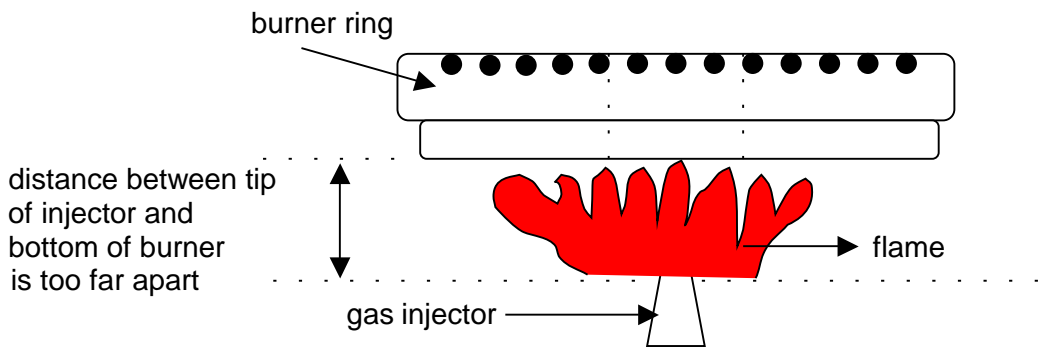
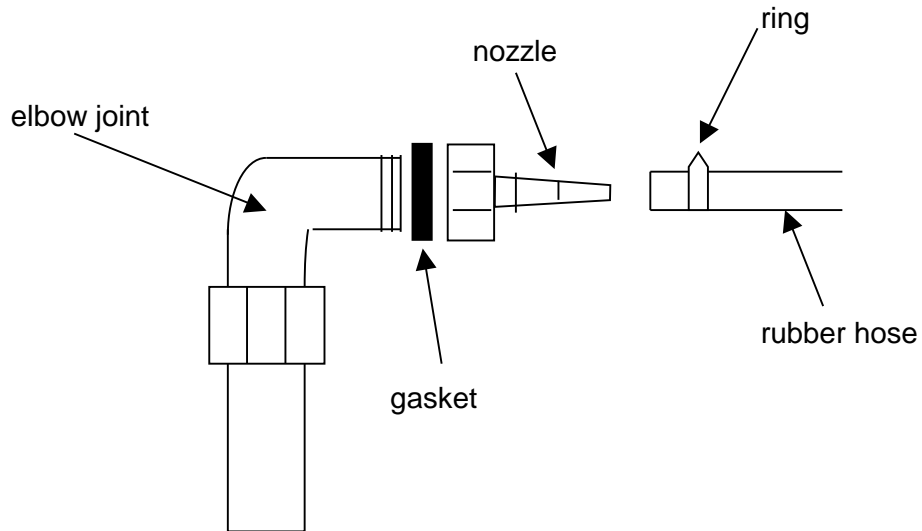

Figure B: Not Acceptable

The weak gas flow arises due to the distance between the tip of injector and bottom of burner is too far apart and causes the flame to heat the burner ring instead of the cooking appliance

INSTALLATION INSTRUCTIONS FOR FIXING GAS COOKER ELBOW JOINT



The gasket depicted above is to prevent gas leakage. After installation, turn on the gas supply and use soap solution (never use naked flame) to check for gas leakage.

ACCEPTABLE AND NON-ACCEPTABLE 2-PIN MAINS PLUG

SOURCE: CEE 7:1963 Standard Sheet XVII
IEC 83:1975 Standard C6

NOTES: Intended to be fitted to Class II (double insulated) appliances
10/16 A, 250 V
Two-pole – no earth contact

OTHER RATINGS: None

OUTLINE:

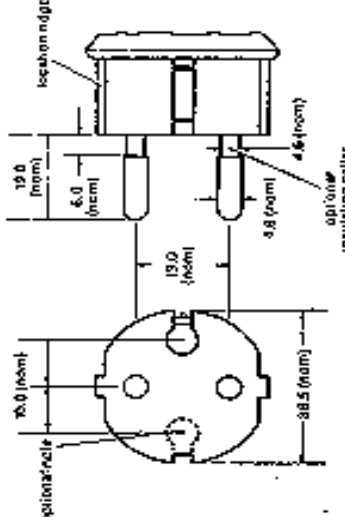

TYPICAL PLUG:



UNACCEPTABLE

SOURCE: CEE 7:1963 Standard Sheet XVI
IEC 83:1975 Standard C5

NOTES: This plug is available in two profiles (see page 12)
Version I: round plug
Version II: flat plug, with insulating collar
Intended to be fitted to Class II (double insulated) appliances
2.5 A, 250 V
Two-pole – no earth contact

OTHER RATINGS: None

OUTLINE: Version II

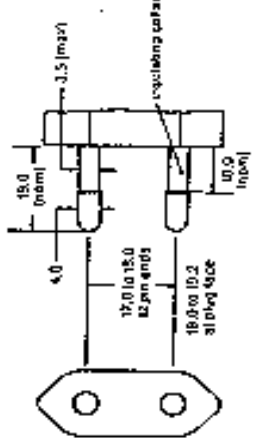

TYPICAL PLUG:

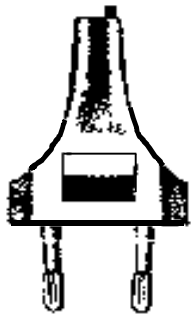

ACCEPTABLE

SINGAPORE CONSUMER PROTECTION (SAFETY REQUIREMENTS)
REGISTRATION SCHEME

Appendix X

DIAGRAM SHOWING A METAL RING AROUND GLASS BOWL USED WITH
ROASTER

