

# Application Note AN-983

## IGBT Characteristics

1. How The IGBT Complements The Power MOSFET .....	1
2. Silicon Structure And Equivalent Circuit .....	2
3. Conduction Characteristics.....	2
4. Switching Characteristics .....	3
5. Latching.....	4
6. Safe Operating Area.....	4
7. Transconductance .....	5
8. How To Read The Data Sheet .....	5
8.1. The Headline Information .....	6
8.2. The Absolute Maximum Ratings.....	6
8.3. Thermal Resistance .....	7
8.4. Electrical Characteristics.....	7
8.5. Switching Characteristics.....	9
9: The IGBT Families from IR .....	<b>13</b>

IGBTs are minority carrier devices, and have superior conduction characteristics, while sharing many of the appealing features of power MOSFETs such as ease of drive, wide SOA, peak current capability and ruggedness. A line of IGBTs from International Rectifier has switching characteristics that are very close to those of power MOSFETs, without sacrificing the much superior conduction characteristics.

# IGBT Characteristics

(HEXFET<sup>®</sup> is a trademark of International Rectifier)

## Topics covered:

How the IGBT complements the MOSFET  
 Silicon structure and equivalent circuit  
 Conduction characteristics and “switchback”  
 Switching characteristics  
 Latching  
 Safe Operating Area  
 Transconductance  
 How to read the data sheet  
 Families of IGBTs

## 1. HOW THE IGBT COMPLEMENTS THE POWER MOSFET

Switching speed, peak current capability, ease of drive, wide SOA, avalanche and  $dv/dt$  capability have made power MOSFETs the logical choice in new power electronic designs. These advantages, a natural consequence of being majority carrier devices, are partly mitigated by their conduction characteristics which are strongly dependent on temperature and voltage rating.

Furthermore, as the voltage rating goes up, the inherent reverse diode displays increasing  $Q_{rr}$  and  $T_{rr}$  which leads to increasing switching losses.

IGBTs on the other hand, being minority carrier devices, have superior conduction characteristics, while sharing many of the appealing features of power MOSFETs such as ease of drive, wide SOA, peak current capability and ruggedness. Generally speaking, the switching speed of an IGBT is inferior to that of power MOSFETs. However, as detailed in INT-990 Sec VIII, a new line of IGBTs from International Rectifier has switching characteristics that are very close to those of power MOSFETs, without sacrificing the much superior conduction characteristics.

The absence of the integral reverse diode gives the user the flexibility of choosing an external fast recovery diode to match a specific requirement or to purchase a “co-pak”, i.e. an IGBT and a diode in the same package. The lack of an integral diode can be an advantage or a disadvantage, depending on the frequency of operation, cost of diodes, current requirement, etc.

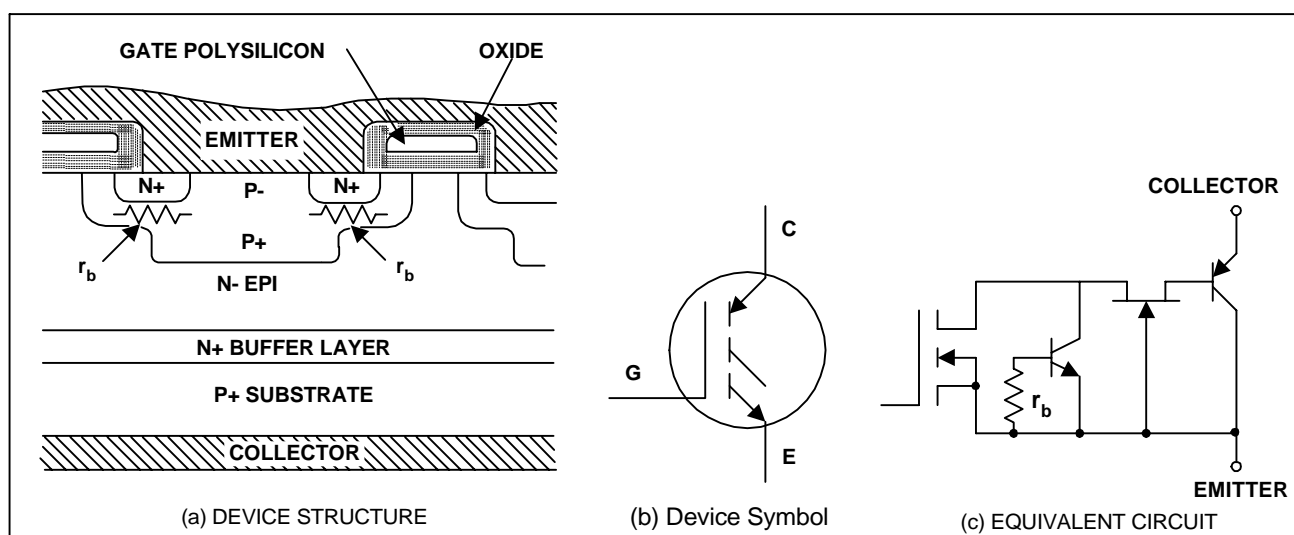

**Figure 1.** Silicon cross-section of an IGBT with its equivalent circuit and symbol (N-Channel, enhancement mode). The terminal called collector is, actually, the emitter of the PNP. In spite of its similarity to the cross-section of a power MOSFET, operation of the two transistors is fundamentally different, the IGBT being a minority carrier device.

## **2. SILICON STRUCTURE AND EQUIVALENT CIRCUIT**

Except for the P+ substrate, the silicon cross-section of an IGBT (Figure 1) is virtually identical to that of a power MOSFET. Both devices share a similar polysilicon gate structure and P wells with N+ source contacts. In both devices the N- type material under the P wells is sized in thickness and resistivity to sustain the full voltage rating of the device.

However, in spite of the many similarities, the physical operation of the IGBT is closer to that of a bipolar transistor than to that of a power MOSFET. This is due to the P+ substrate which is responsible for the minority carrier injection into the N-region and the resulting conductivity modulation. In a power MOSFET, which does not benefit from conductivity modulation, a significant share of the conduction losses occur in the N-region, typically 70% in a 500V device.

As shown in the equivalent circuit of Figure 1, the IGBT consists of a PNP driven by an N-Channel MOSFET in a pseudo-Darlington configuration. The JFET has been included in the equivalent circuit to represent the constriction in the flow of current between adjacent P-wells. The cell density of the MOSFET structure is higher than that of a high-voltage, comparable technology MOSFET and, consequently, has better Resistance-Area product.

The base region of the PNP is not brought out and the emitter-base PN junction, spanning the entire extension of the wafer cannot be terminated nor passivated. This influences the turn-off and reverse blocking behavior of the IGBT, as will be explained later. The breakdown voltage of this junction is about 20V and is shown in the IGBT symbol as an unconnected terminal (Figure 1).

## **3. CONDUCTION CHARACTERISTICS**

As it is apparent from the equivalent circuit, the voltage drop across the IGBT is the sum of two components: a diode drop across the P-N junction and the voltage drop across the driving MOSFET. Thus, unlike the power MOSFET, the on-state voltage drop across an IGBT never goes below a diode threshold. The voltage drop across the driving MOSFET, on the other hand, has one characteristic that is typical of all low voltage MOSFETs: it is sensitive to gate drive voltage. This is apparent from Figures 12 and 13 where, for currents that are close to their rated value, an increase in gate voltage causes a reduction in collector-to-emitter voltage. This is due to the fact that, within its operating range, the gain of the PNP increases with current and an increase in gate voltage causes an increase in channel current, hence a reduction in voltage drop across the PNP. This is quite different from the behavior of a high voltage power MOSFET that is largely insensitive to gate voltage.

As the final stage of a pseudo-Darlington, the PNP is never in heavy saturation and its voltage drop is higher than what could be obtained from the same PNP in heavy saturation. It should be noted, however, that the emitter of an IGBT covers the entire area of the die, hence its injection efficiency and conduction drop are much superior to that of a bipolar transistor of the same size.

Two options are available to the device designer to decrease the conduction drop:

1. Reduce the on-resistance of the MOSFET. This can be done by increasing the die size and/or the cell density.
2. Increase the gain of the PNP. As explained later, this option is limited by latch-up considerations and voltage withstanding capability.

International Rectifier has been pursuing the optimization of the MOSFET component of the IGBT to the point where its devices can be correctly referred to as a "conductivity modulated MOSFET" with its characteristic features of high speed, low voltage drop and efficient silicon utilization. Other semiconductor companies, on the other hand, have concentrated on the optimization of the bipolar part and the resulting product should be more correctly referred to as a "MOSFET-driven transistor" with a different set of characteristics.

The dramatic impact of conductivity modulation on voltage drop can be seen from Figure 2 which compares a HEXFET® power MOSFET and an IGBT of the same die size. Temperature dependence, very significant in a power MOSFET, is minimal in an IGBT, just enough to ensure current sharing of paralleled devices at high current levels under steady state conditions, as shown in Figure 14 for the IRGBC20U. This same figure shows that the temperature dependence of the voltage drops is different at different current levels. This is because the diode component of this drop has a temperature coefficient that is initially negative becoming positive at higher current levels. The MOSFET component, on the other hand, is positive. The problem is made more complex by the fact that these two components are weighted differently at different current and temperatures.

In addition to reducing the voltage drop and its temperature coefficient, conductivity modulation virtually eliminates its dependence on the voltage rating. This is shown in Table I, where the conduction drops of four IGBTs of different voltage ratings are compared with those of HEXFET<sup>®</sup>s at the same current density. A common misconception is that power MOSFETs exhibit a voltage dependence of the  $R_{DS(on)}$  of the following type:

$$R = R_0 V^\alpha \text{ with } \alpha = 2.5,$$

i.e., the on-resistance increases with the voltage rating at a higher rate than a square law. In reality, assuming that a power law is a true representation of the underlying physical phenomena, the correct value would be  $\approx 1.6$ , as can be easily verified from the data sheets of any manufacturer. These data sheets will also contradict the common misconception that power MOSFETs have better silicon utilization at low voltage. In actual fact they achieve their highest power handling capability per unit area between 400V and 600V, even if they are unbeatable at low voltages, on account of their resistive voltage drop. The voltage drop of a conductivity modulated device with minority lifetime killing may exhibit a peculiar behavior frequently referred to as ‘switchback’: the voltage drop at low current and low temperature is higher than expected, suddenly dropping to its expected value if current or temperature are increased. The term comes from the fact that, when measuring voltage drop with a curve tracer, the trace suddenly ‘switches’ to the left of the screen as the current increases. This behavior is ascribed to lifetime killing which, in so far as it facilitates recombination, delays the onset of conductivity modulation. Hence, the voltage drop for current levels below conductivity modulation is higher than for a somewhat higher collector current, after conductivity modulation is established. This phenomenon is one of the causes of the “forward recovery” of fast (reverse recovery) diodes and of higher values of latching current in minority lifetime killed thyristors. A trace of this phenomenon can be seen in the “bump” in the  $V_{CE(Sat)}$  portion of Figure 12. Notice that the bump disappears in Figure 13 because temperature increases the lifetime of the charges and speeds up the onset of conductivity modulation. Notice, also, that only the Ultrafast IGBTs exhibit this phenomenon, because of higher levels of lifetime killing.

Rated Voltage	IGBT	100	300	600	1200
	HEXFET <sup>®</sup>	100	250	500	1000
Typical Voltage Drop @ 1.7A/mm <sup>2</sup> , 100°C	IGBT	1.5	2.1	2.4	3.1
	HEXFET <sup>®</sup>	2.0	11.2	26.7	100

**Table 1:** Dependence of Voltage Drop From Voltage Rating

The voltage rating of the HEXFET<sup>®</sup> power MOSFETs used in this comparison are lower than the IGBTs to take into account their avalanche capability.

#### 4. SWITCHING CHARACTERISTICS

The biggest limitation to the turn-off speed of an IGBT is the lifetime of the minority carriers in the N-epi, i.e., the base of the PNP. Since this base is not accessible, external drive circuitry cannot be used to improve the switching time. It should be remembered, though, that since the PNP is in a pseudo-Darlington connection, it has no storage time and its turn-off time is much faster than the same PNP in heavy saturation. Even so, it may still be inadequate for many high frequency applications.

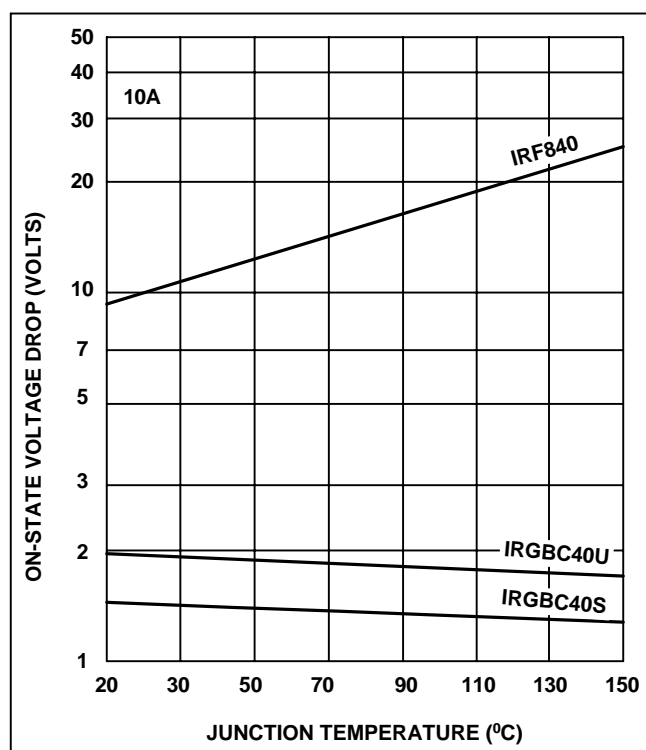

**Figure 2.** On-state voltage drop as temperature of two IGBTs of different switching characteristics compared to those of a HEXFET of the same die size (IRGBC40S and IRGBC40U vs IRF840). Conductivity modulation causes a dramatic improvement in the on-state voltage drop. To take the avalanche capability of the HEXFET into account, a 500V device is compared with 600V IGBTs.

The charges stored in the base cause the characteristic "tail" in the current waveform of an IGBT at turn-off (Figure 3). As the MOSFET channel stops conducting, electron current ceases and the IGBT current drops rapidly to the level of the hole recombination current at the inception of the tail.

This tail increases turn-off losses and requires an increase in the deadtime between the conduction of two devices in a half-bridge. Traditional lifetime killing techniques and/or an N+ buffer layer to collect the minority charges at turn-off are commonly used to speed-up recombination time.

Insofar as they reduce the gain of the PNP, these techniques increase the voltage drop. Pushed to the extreme, minority lifetime killing causes a quasi-saturation condition at turn-on, as shown in Figure 4, where the turn-on losses have become larger than the turn-off losses.

Thus, the gain of the PNP is constrained by conduction and turn-on losses on one hand, and by latching considerations on the other, as explained in the next section. Like all minority carrier devices, the switching performance of an IGBT degrades with temperature.

IGBTs operated in zero current switching may exhibit quasi-saturation losses at turn-on that are somewhat higher than in switchmode circuits.

The low  $di/dt$  that is characteristic of this mode of operation emphasizes the "switchback" phenomenon described in the previous section. Similarly, with zero-voltage turn-off, the IGBT may experience a short burst of current if the complementary device is turned on soon after the current has ceased in the one that was conducting.

This is due to the fact that the turn-on of the complementary device causes the supply voltage to appear across the first IGBT, thereby depleting its base region and causing a final sweep-out of the minority carriers that were still left there. There is, however, a component of current that is due to the charging of the device capacitances and is totally unrelated to minority carriers.

## 5. LATCHING

As shown in the cross-section of Figure 1, the IGBT is made of four alternate P-N-P-N layers. Given the necessary conditions ( $\alpha_{NPN} + \alpha_{PNP} > 1$ ) the IGBT could latch-up like a thyristor. The N+ buffer layer and the wide epi base reduce the gain of the PNP, while the gain of the NPN, which is the parasitic bipolar of the MOSFET, can be reduced with the same techniques [1] that are commonly employed to give HEXFET<sup>®</sup>s their avalanche and  $dv/dt$  capability, mainly a drastic reduction of the  $r'_b$ . If this  $r'_b$  is not adequately reduced, "dynamic latching" could occur at turn-off when a high density of hole current flows in  $r'_b$ , taking the gain of the parasitic NPN to much higher values.

## 6. SAFE OPERATING AREA

The safe operating area (SOA) describes the capability of a transistor to withstand significant levels of voltage and current at the same time. The three main conditions that would subject an IGBT to this combined stress are the following:

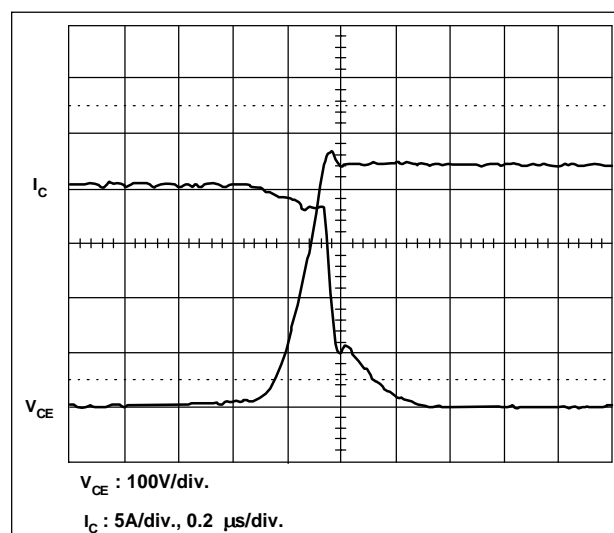

**Figure 3.** Turn-off waveform of a commercial IGBT at 250C, rated current. Notice the clean break at the inception of the "tail". Switching circuit as in Figure 16.

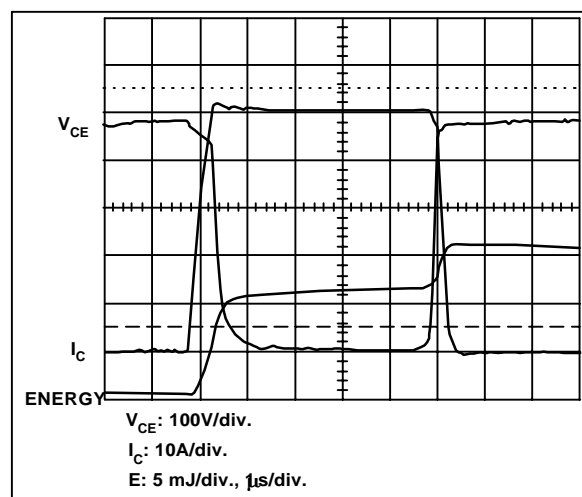
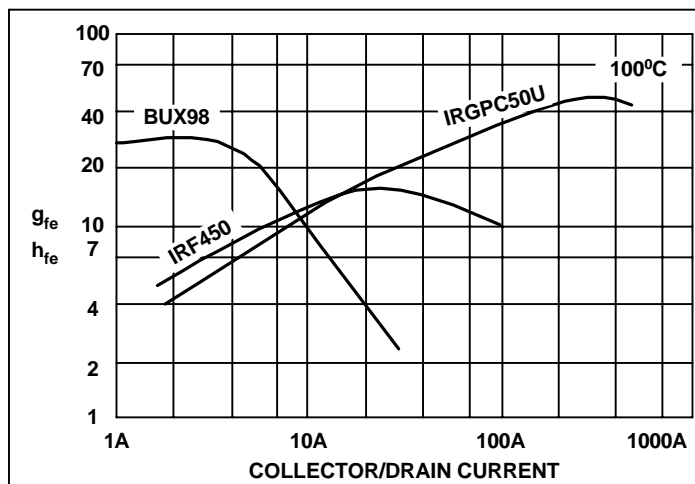

**Figure 4.** Switching waveforms of a commercially available IGBT with heavy lifetime killing. It takes approximately 0.5ms for the voltage to drop the last 50V. The energy plot shows that the losses at turn-on are twice as high as those at turn-off. Switching circuit as in Figure 16.

1. Operation in short circuit. The current in the IGBT is limited by its gate voltage and transconductance and can reach values well in excess of 10 times its continuous rating. The level of hole current that flows underneath the N+ source contact can cause a drop across  $r'_b$ , large enough to turn on the NPN parasitic bipolar with possible latching. This is normally prevented by a reduction in  $r'_b$ , as mentioned in the previous section or by a reduction of the total device transconductance. Since this second technique increases conduction losses and reduces switching speed, two families of IGBTs have been made available by IR, one optimized for low conduction losses, the other for short circuit operation, as indicated in Section 9.
2. Inductive turn-off, sometimes referred to as "clamped  $I_L$ ." In an inductive turn-off the voltage swings from a few volts to the supply voltage with constant current and with no channel current. These conditions are different from those described in the previous section in so far as the load current is totally made up of holes flowing through  $r'_b$ . For this reason some manufacturers suggest the use of gate drive resistors to slow down the turn-off  $dv/dt$  and maintain some level of electron current, thereby avoiding a potential "dynamic latching" condition. IGBTs from International Rectifier can be operated at their maximum switching speed without any problem. Reasons to limit the switching speed should be external to the device (e.g., overshoots due to stray inductance), rather than internal.
3. Operation as a linear amplifier. Linear operation exercises the SOA of the IGBT in a combination of the two modes described above. No detailed characterization of IGBTs as linear amplifiers has been carried out by IR, given the limited use of IGBTs in this type of application.

## 7. TRANSCONDUCTANCE

The current handling capability of a semiconductor can be limited by thermal constraints or by gain / transconductance constraints. While the "headline current rating" of power semiconductors is based solely on thermal considerations, it is entirely possible, as is frequently the case with bipolar transistors, that the device cannot operate at the current level it is thermally capable of, because its gain has fallen to very low values. As shown in Figure 5, the transconductance of an IGBT tops out at current levels that are well beyond its thermal capability, while the gain of a bipolar of similar die size is on a steep downslope within its current operating range. The flattening out of transconductance occurs when the saturation effects in the MOSFET channel, that reduce the base current of the PNP, combine with the flattening of the gain of the PNP. Since temperature reduces the MOSFET channel current more than it increases the gain of the PNP, the saturation in transconductance occurs at lower current as the temperature increases.

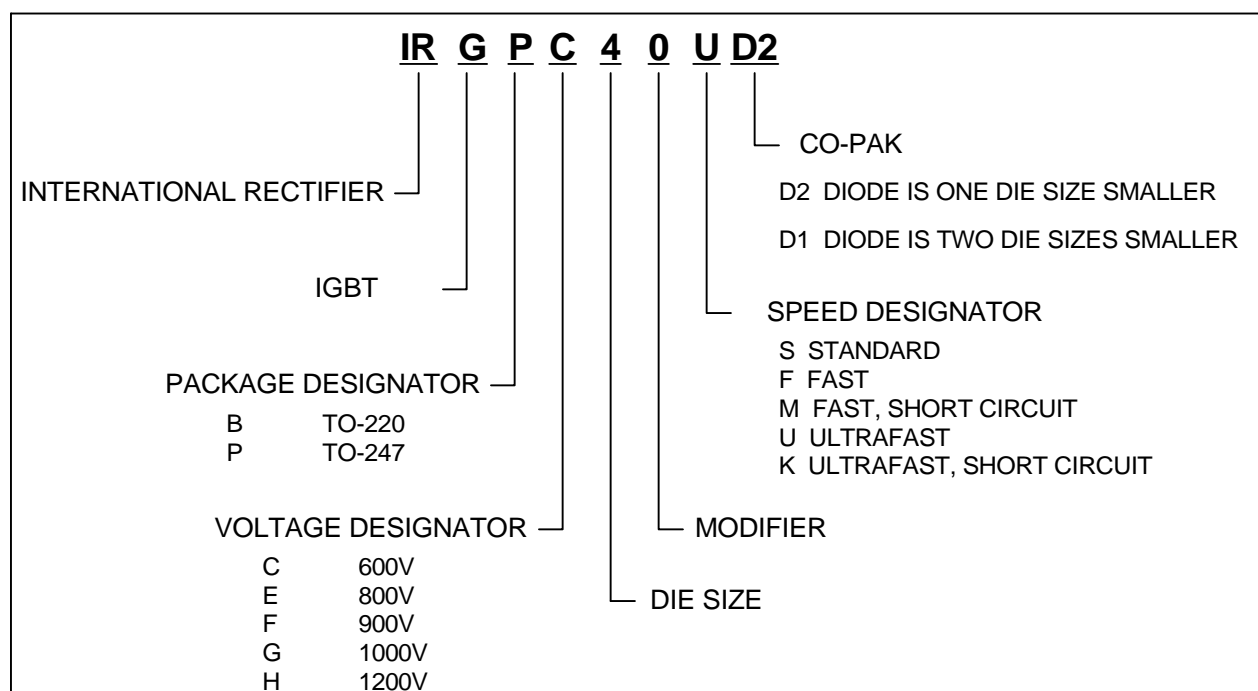

**Figure 5.** Current dependence of the transconductance of an IGBT compared to that of a HEXFET and to the gain of a bipolar of approximately the same die size. The IGBT, like the power MOSFET, is not "gain limited."

Since lifetime killing reduces the gain of the PNP, the transconductance of fast IGBTs peaks at a lower level than those without lifetime killing. This, however, is a second order effect because the gain of the PNP is determined mainly by the N+ buffer layer. The decrease in transconductance at very high current and its additional decrease with temperature helps protect the IGBT under short circuit conditions. With a gate voltage of 15V, the current density of a standard IGBT from International Rectifier reaches values of 10-20A/mm<sup>2</sup> in short circuit. This high transconductance is partly responsible for their superior switching and conduction characteristics.

## 8. HOW TO READ THE DATA SHEET

International Rectifier prides itself on having one of the most comprehensive IGBT data sheets in the industry, with all the information required to operate the IGBT reliably. However, like all technical documents it requires a good understanding by the user of the different terms and conditions. These are briefly explained in the following sections.



**Figure 6.** Simplified nomenclature code for commercial IGBTs from International Rectifier

## 8.1. The Headline Information

In addition to the mechanical layout, the front page gives the voltage drop at the 100°C current ratings. The part number itself contains in coded form the key features of the IGBT, as explained in Figure 6.

## 8.2. The Absolute Maximum Ratings

This table sets up a number of constraints on device operation that apply under any circumstance.

**Continuous Collector Current** @  $T_C = 25^\circ\text{C}$  and  $100^\circ\text{C}$  ( $I_C$ ). This represents the dc current level that will take the junction to its rated temperature from the stipulated case temperature. It is calculated with the following formula:

$$I_C = \frac{\Delta T}{\theta_{j-c} \cdot V_{CE(on)} @ I_C}$$

where  $\Delta T$  is the temperature rise from the stipulated case temperature to the maximum junction temperature ( $150^\circ\text{C}$ ). Notice that  $V_{CE(on)} @ I_C$  is not known because  $I_C$  is not known. It can be found with few iterations.

It is clear, from this formula, that a current rating has no meaning without a corresponding junction and case temperature. Since in normal applications the case temperature is much higher than  $25^\circ\text{C}$ , the associated rating is of no practical value and is only reported because transistors have been traditionally rated in this way. Figure 7 shows how this rating changes with case temperature, with a junction temperature of  $150^\circ\text{C}$ , for a specific device.

**Pulsed Collector Current ( $I_{CM}$ ).** Within its thermal limits, the IGBT can be used to a peak current well above the rated continuous DC current. The temperature rise during a high current transient can be calculated as indicated in Section Y. The test circuit is shown in Figure 8.

**Collector-to-Emitter Voltage ( $V_{CE}$ ).** Voltage across the IGBT should never exceed this rating, to prevent breakdown of the collector-emitter junction. The breakdown itself is guaranteed in the Table of Electrical Characteristics.

**Maximum Gate-to-Emitter Voltage ( $V_{GE}$ ).** The gate voltage is limited by the thickness and characteristics of the gate oxide layer. Though the gate dielectric rupture is typically around 80 volts, the user is limited to 20V to limit current under fault conditions and to ensure long term reliability.

**Clamped Inductive Load Current ( $I_{LM}$ ).** This rating guarantees that the device is able to repetitively turn off the specified current with a clamped inductive load, as encountered in most applications. In fact, the test circuit (Figure 9) exposes the IGBT to the peak recovery current of the free-wheeling diode, which adds a significant component to the turn-on losses (Figure 10). This rating guarantees a square switching SOA, i.e., that the device can sustain high voltage and high current simultaneously. The  $I_{LM}$  rating is specified at 150°C, 80% of the rated voltage. This complements the information supplied by the RBSOA.

**Reverse Avalanche Energy ( $E_{ARV}$ ).** This subject is covered in detail in the  $BV_{ECS}$  section of the electrical characteristics.

**Maximum Power Dissipation @ 25°C and 100°C ( $P_D$ ).** It is calculated with the following formula:

$$P_D = \frac{\Delta T}{\theta_{j-c}}$$

The same comments that were made on the Continuous Collector Current apply to Power Dissipation.

**Junction Temperature ( $T_j$ ):** the device can be operated in the industry standard range of -55°C to 150°C.

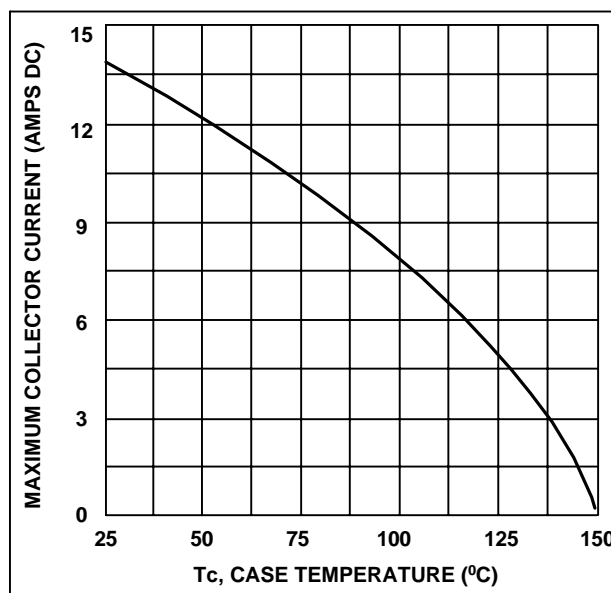

Figure 7. Maximum Collector Current vs. Case Temperature

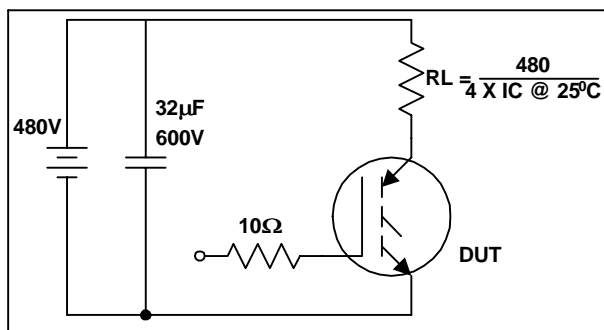

Figure 8. Pulsed Collector Current Test Circuit

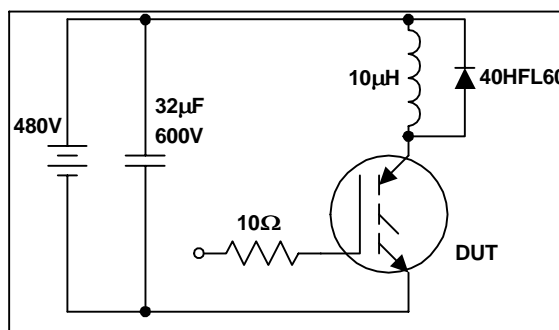

Figure 9. Clamped Inductive Load Test Circuit

### 8.3. Thermal Resistance

$R_{thjc}$ ,  $R_{thcs}$ ,  $R_{thja}$  are needed for the thermal design, as explained in INT-949

### 8.4. Electrical Characteristics

The purpose of this section is to provide a detailed characterization of the device so that the designer can predict with accuracy its behavior in a specific application.

**Collector-to-Emitter Breakdown Voltage ( $BV_{CES}$ ).** This parameter guarantees the lower limit of the distribution in breakdown voltage. Breakdown is defined in terms of a specific leakage current and has a positive temperature coefficient (listed in the table as  $BV_{CES}/\Delta T$ ) of about 0.63V/°C. This implies that a device with 600V breakdown at 25°C would have a breakdown voltage of 550V at -55°C.



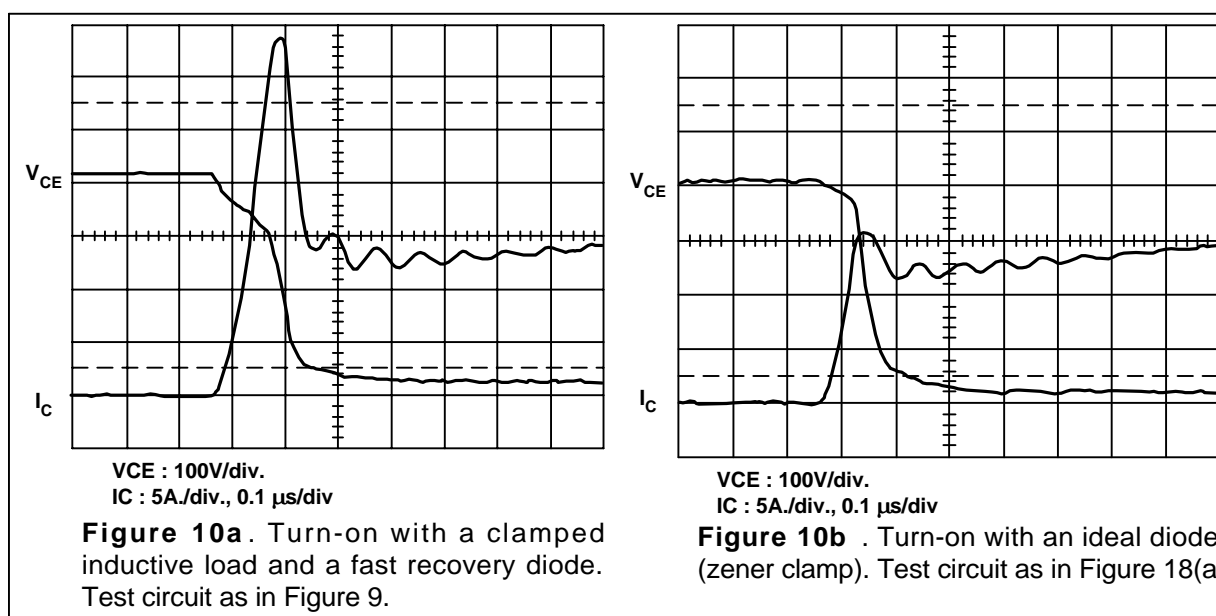

The reverse recovery is a significant contributor to turn-on losses. To discriminate between the losses that are intrinsic to the IGBT and those due to the diode reverse recovery, the test circuit shown in Figure 16 has been used to generate the data sheet values.

**Emitter-to-Collector Breakdown Voltage ( $BV_{ECS}$ ).** This rating characterizes the reverse breakdown of the unterminated collector-base junction of the PNP. The relevance of this specification and its associated reverse avalanche energy can be better understood with reference to Figure 11. When an IGBT turns off and current is transferred to the diode across the complementary device, the turn-off  $di/dt$  in the stray inductance that is in series with the diode generates a reverse voltage spike across the IGBT (i.e., the collector voltage goes negative with respect to the emitter). This reverse voltage is typically less than 10V, though higher voltages can result from very high  $di/dt$  or poor layout. Since this reverse voltage can cause avalanche in the junction, International Rectifier IGBTs have an energy rating, given in the Absolute Maximum Ratings table, that is more useful to the designer than a traditional diode characterization. This rating is typically an order of magnitude more than what would be required by the user.

**Collector-to-Emitter Saturation Voltage ( $V_{CE(on)}$ ).** Being the key rating to calculate conduction losses, this value is supported by three figures that provide a detailed characterization in temperature, current and gate voltage (Figures 14, 15, and 16 for the IRGBC20U). These replace the older format shown in Figure 12 and 13.

**Gate Threshold Voltage ( $V_{GE(th)}$ ).** This is the range of voltage on the gate at which collector current starts to flow. The variation in gate threshold with temperature is also specified ( $\Delta V_{GE(th)} / \Delta T_j$ ). Typically the coefficient is -11 mV/ $^{\circ}$ C, leading to a reduction of about 1.4V in the threshold voltage at high temperature.

**Forward Transconductance ( $g_{FE}$ ).** This parameter is measured by superimposing a small variation on a gate bias that takes the IGBT to its 100 $^{\circ}$ C rated current in "linear" mode. As mentioned in Section 7, transconductance increases significantly with current so that the "current throughput" of an IGBT is not limited by gain, as a bipolar, but by thermal considerations.

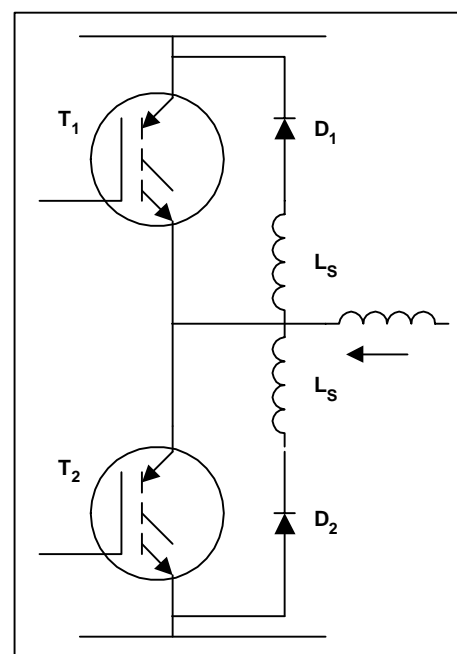

**Figure 11.** When T2 goes off, load current flows into the diode in parallel with T1. The reverse turn-off  $di/dt$  of T2 develops a voltage across the stray inductance in series with D1 which reverse biases T1. IR's IGBTs have a specified reverse blocking capability ( $BV_{CES}$ ) and an avalanche rating ( $E_{RV}$ )

**Zero-Gate-Voltage Collector Current ( $I_{CES}$ ).** This parameter guarantees the upper limit of the leakage distribution at the rated voltage and two temperatures. It complements the  $BV_{CES}$  rating seen above.

## 8.5. Switching Characteristics

**GateChargeParameters ( $Q_g, Q_{ge}, Q_{gc}$ ).** Gate charge values of an IGBT are useful to size the gate drive circuit and estimating gate drive losses. Unfortunately they cannot be used to predict switching times, as for a power MOSFET, because of the minority carrier nature of this device. The test method and the characteristics described in the application note INT-944. Figure 17 gives the typical value of the total gate charge as a function of the voltage applied to the gate. The shape of the curve is explained in detail in INT-944.

**Switching Times ( $t_d, t_r, t_f$ ).** The switching times for a simple IGBT are defined with reference to the Switching Loss Test Circuit of Figure 18. Those for co-paks are defined with reference to the Clamped Inductive Load of Figure 19.

For a simple device, they are defined as follows:

- Turn-on delay time: 10% of gate voltage to 10% of collector current
- Rise time: 10 to 90% of collector current
- Turn-off delay time: 90% of gate voltage to 90% of collector current
- Fall time: 90 to 10% of collector current.

For a copak, they are defined as follows:

- Turn-on delay time: 10% of gate voltage to 10% of collector current
- Rise time: 10 to 90% of collector current
- Turn-off delay time: 90% of gate voltage to 10% of collector voltage
- Fall time: 90 to 10% of collector current.

Switching times provide a useful guideline to establish the appropriate deadtime between the turn-off and subsequent turn-on of complementary devices in a half bridge configuration and the minimum and maximum pulse widths. They provide a very unreliable indication of switching losses. Because of the current tail mentioned in Section 8.2, a significant part of the turn-off energy may be dissipated as the current is below 10%. The voltage fall time, on the other hand, is not characterized in any way. Thus, two significant contributors to losses are not properly accounted for by the switching times. Switching losses are fully characterized as such in the data sheet, as explained in the next paragraph.

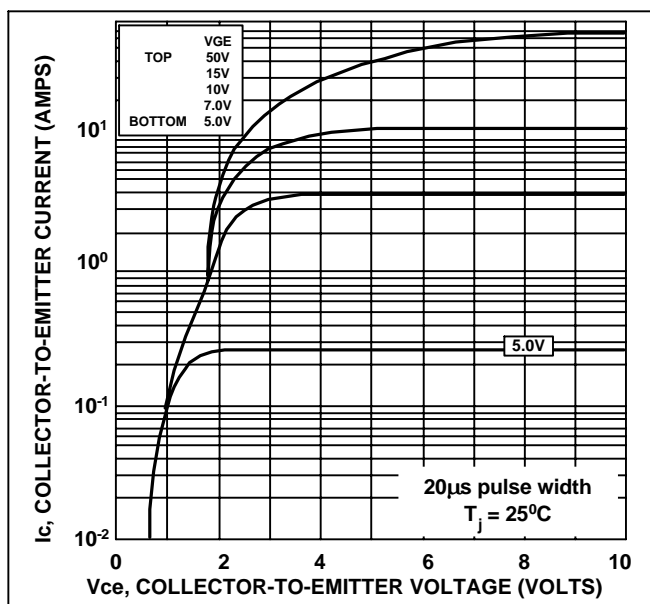

Figure 12. Typical Output Characteristics.  $T_c = 25^\circ\text{C}$

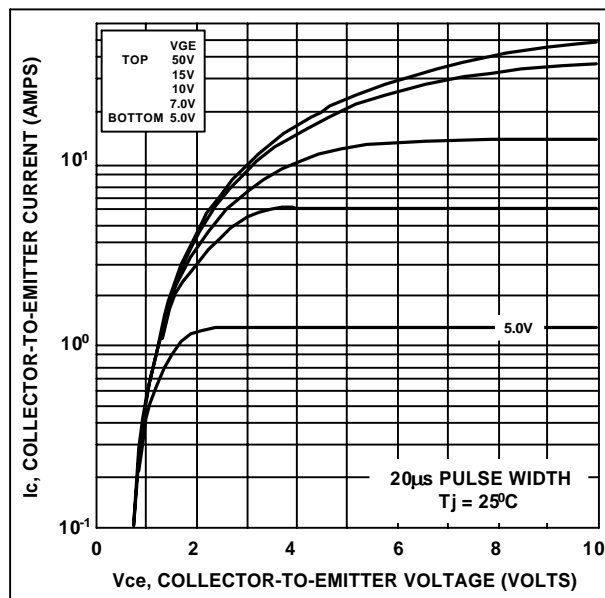

Figure 13. Typical Output Characteristics,  $T_c = 150^\circ\text{C}$

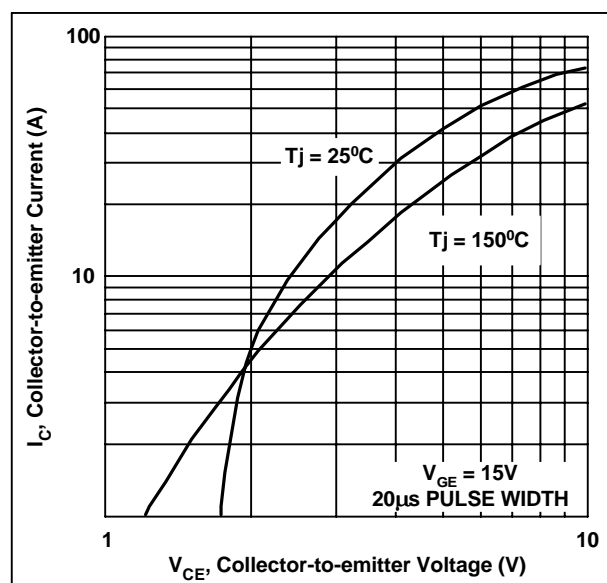

Figure 14.

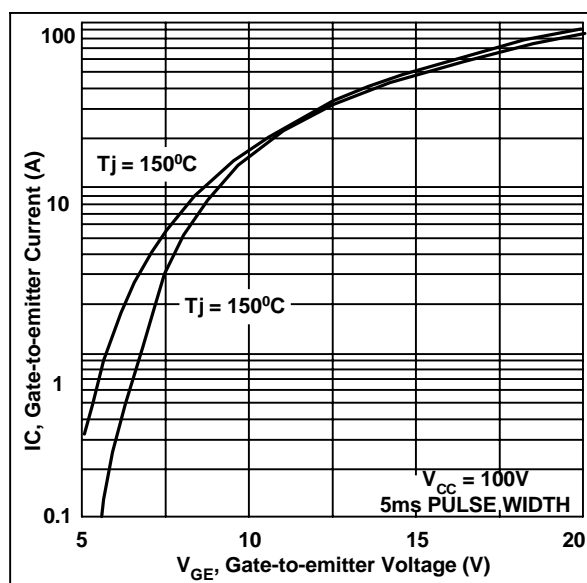

Figure 15.

It should be remembered that IGBTs, like power MOSFETs, do not have a storage time. The turn-off delay is due to the Miller effect, as explained in Section I.A of INT-990.

**Switching Energy ( $E_{on}$ ,  $E_{off}$ ,  $E_{ts}$ ).** IGBTs from International Rectifier have a guaranteed switching energy providing a full characterization in terms of temperature, collector current and gate resistance (Figures 20, 21 and 22 for the IRGBC20U). This allows the designer to calculate the switching losses, without worrying about the actual current and voltage waveshapes, the tail and the quasi-saturation.

Any test circuit for measuring switching losses has to satisfy two fundamental requirements:

1. It must simulate the switching conditions as they are encountered in a practical application, i.e., a clamped inductive load with continuous current flow.
2. It must reflect the losses that are attributable to the IGBT, and must be independent from those due to other circuit components, like the reverse recovery of the freewheeling diode.

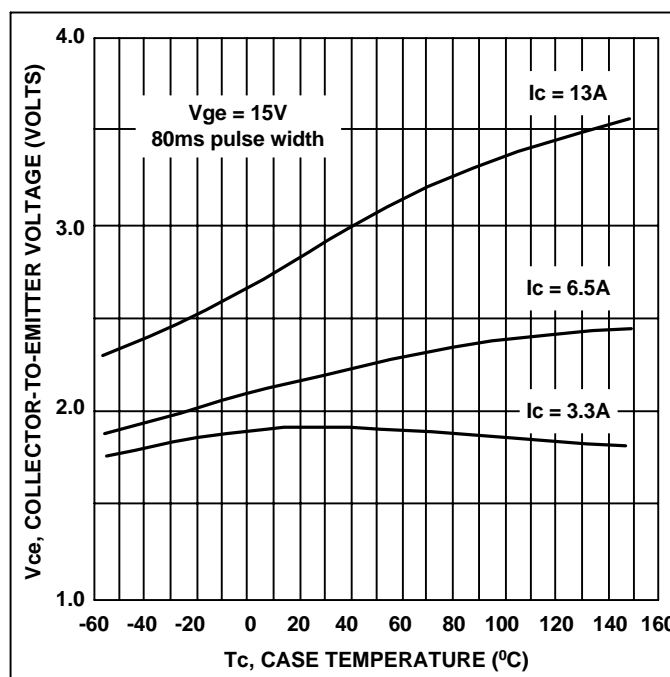

Figure 16. Collector-to-emitter Saturation Voltage vs. Case Temperature

The test *circuit* that meets these requirements for a simple IGBT is shown in Figure 18. Its operation is as follows: The driver IGBT builds the test current in the inductor. When it is turned off, current flows in the zener. At this point the switching time and switching energy test begins, by turning on and off the device under test (DUT). The DUT will see the test current that was flowing into the inductor and the voltage across the zener, *without* any reverse recovery component from a freewheeling diode. This test can exercise the IGBT to its full voltage and current without any spurious effect due to diode reverse recovery.

The test *method*, on the other hand, must account for all losses that occur because of the switching operation, including the quasi-saturation at turn-on and the tail at turn-off. To fulfill this requirement, the energy figures reported in the data sheet are defined as follows:

**$E_{on}$ :** From 5% of test current to 5% of test voltage. We feel that 5% is a reasonable compromise between the resolution of the instrumentation and the need to account for the quasi-saturation that could occur in some devices.

**$E_{off}$ :** This energy is measured over a period of time that starts with 5% of test voltage and goes on for 5  $\mu$ sec. While the current tail of most IGBTs would be finished well before that time, it was felt that the contribution of the leakage losses to the total energy is minimal.

**$E_{ts}$ :** This is the sum of the turn-on and turn-off losses. As shown in Figure 22, switching energy for International Rectifier IGBTs is closely proportional to current. This is not necessarily true for IGBTs from other manufacturers. The test circuit for a co-pack, on the other hand, should include the losses due to the diode, assuming a clamped inductive load with an identical device in a complementary position (Figure 19). The definitions are as follows:

**$E_{on}$ :** From 10% of test current to 5% of test voltage.

**$E_{off}$ :** This energy is measured over a period of time that starts with 10% of test voltage and goes on for 5  $\mu$ sec.

**Internal Emitter Inductance ( $L_E$ )**

This is the package inductance between the bonding pad on the die and the electrical connection at the lead. This inductance slows down the turn-on of the IGBT by an amount that is proportional to the di/dt of the collector current, just like the Miller effect slows it down by an amount that is proportional to the collector dv/dt. With a di/dt of 1000 A/ $\mu$ sec, the voltage developed across this inductance is in excess of 7V.

**Device Capacitances ( $C_{iee}$ ,  $C_{oee}$ ,  $C_{ree}$ ).**

The test circuit and a brief explanation of the test method can be found in Figure 20. The output capacitance has the typical voltage dependence of a P-N junction. The reverse transfer (Miller) capacitance is also strongly dependent on voltage (inversely proportional), but in a more complex way than the output capacitance. The input capacitance, which is the sum of the gate-to-emitter and of the Miller capacitance, shows the same voltage dependence of the Miller capacitance but in a very attenuated form since the gate-to-emitter capacitance is much larger and voltage independent.

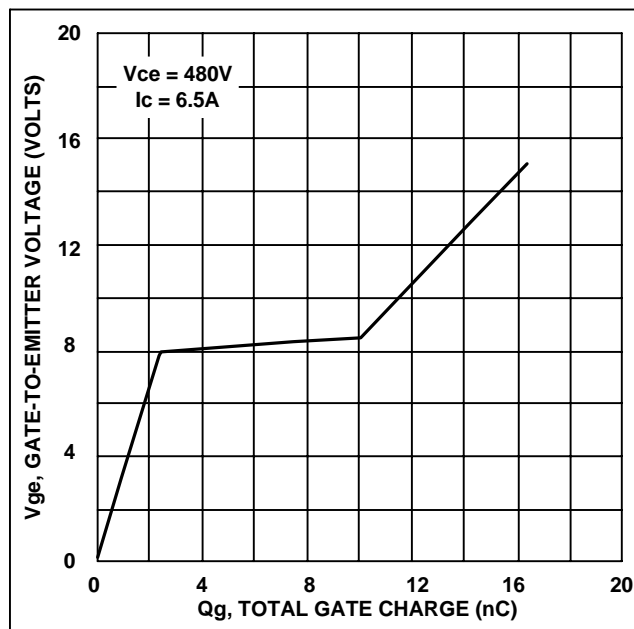
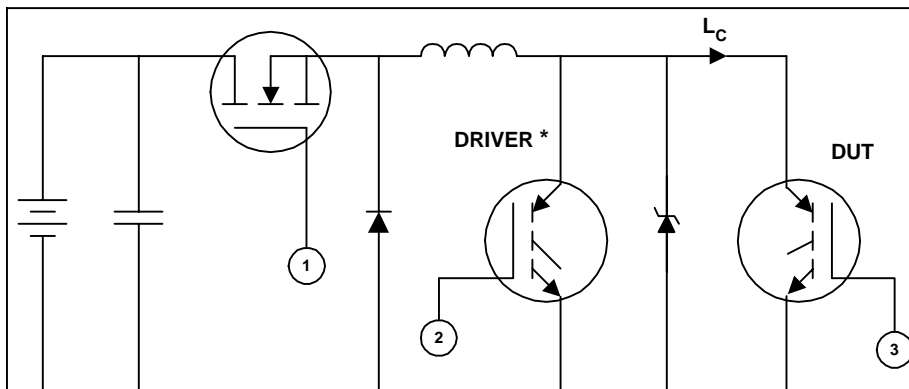

Figure 17. Typical Gate Charge vs. Gate - to - Emmitter Voltage



\* DRIVER SAME TYPE AS DUT  
VC = 80% OF BVCES

Figure 18a

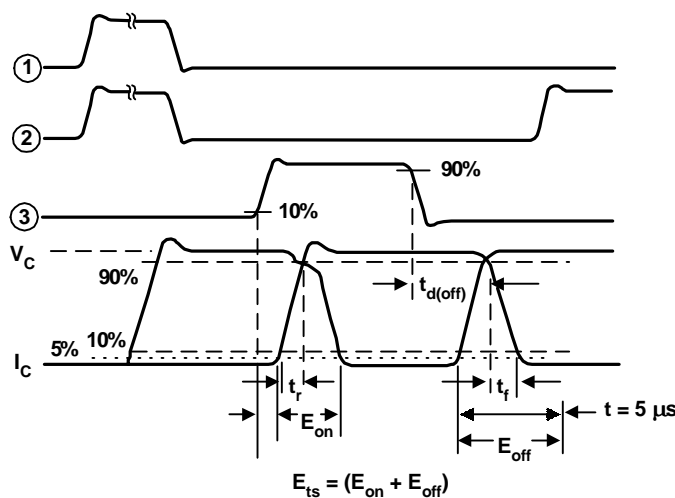

Figure 18b.

Figure 18. Switching Loss Test Circuit and Waveforms

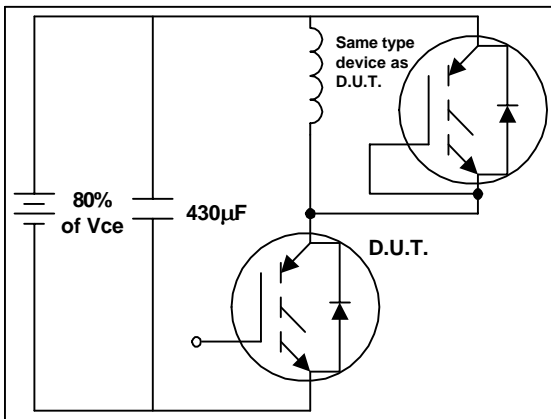

Figure 19a.

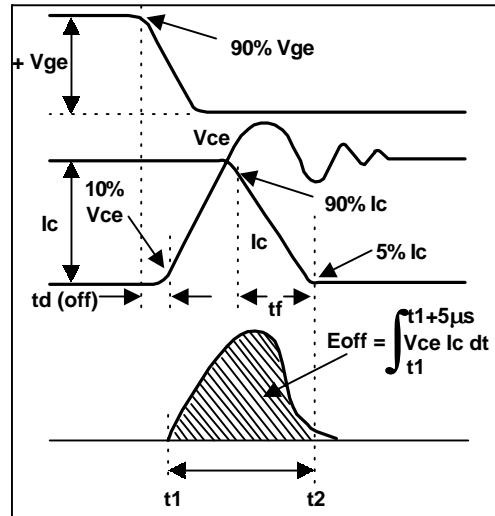

Figure 19b.

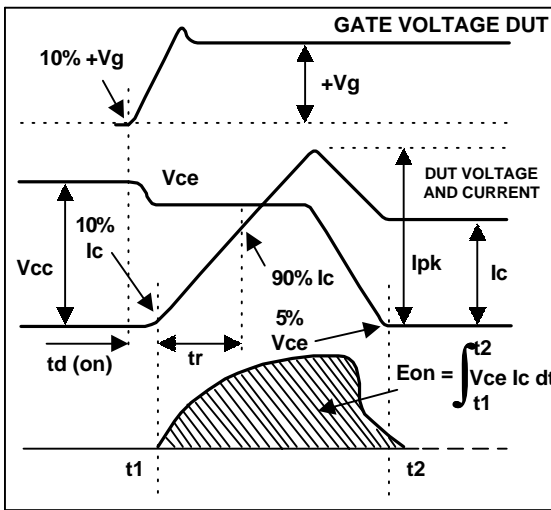

Figure 19c.

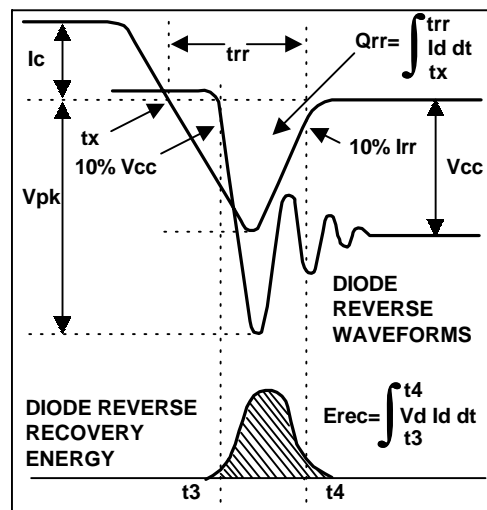

Figure 19d.

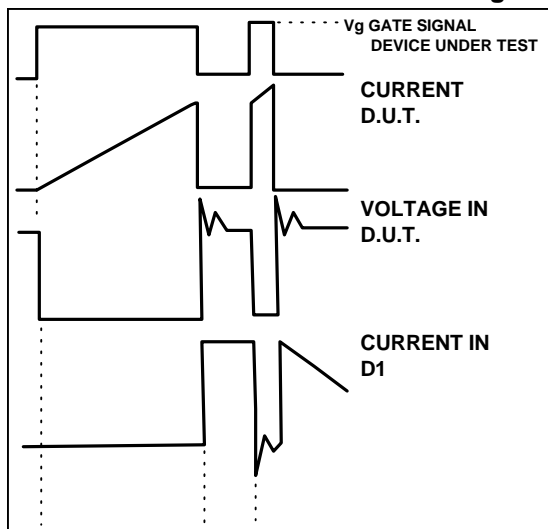

Figure 19e.

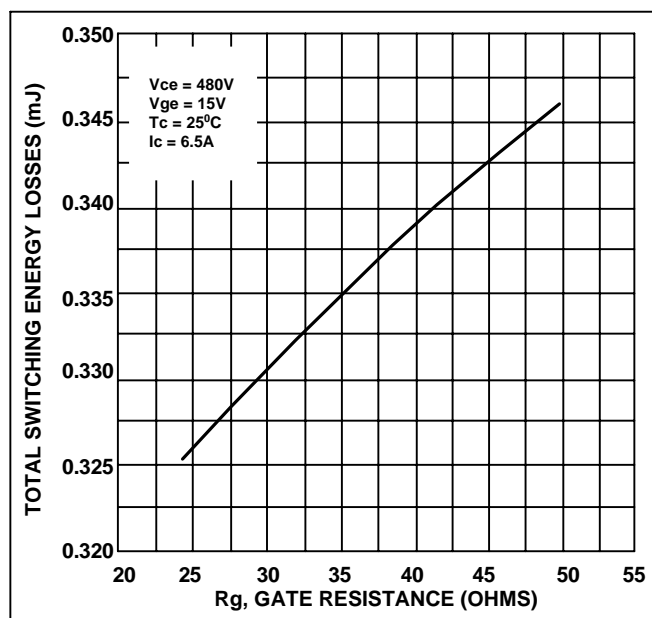

Figure 20. Typical Switching Losses vs. Gate Resistance

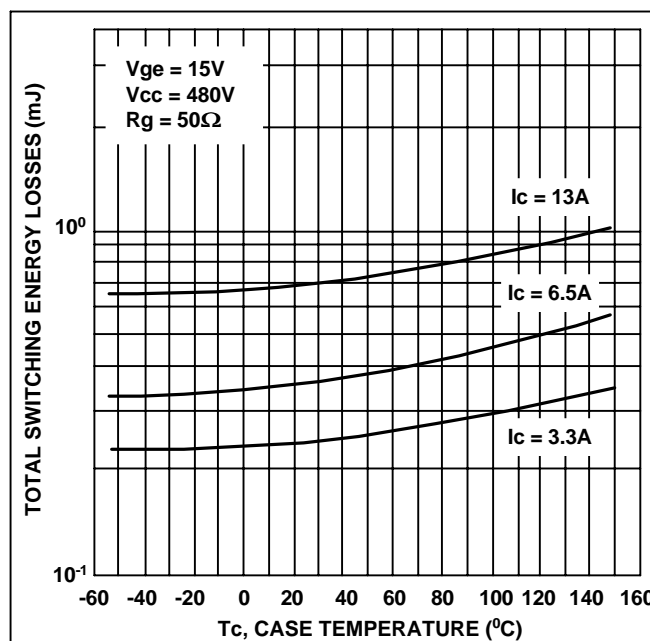

Figure 21. Typical Switching Losses vs. Case Temperature

**The Transfer Characteristic** (Figure 15 for the IRGBC20U). This curve deviates from the traditional definition of transfer characteristic in one detail: the drain is not connected to the gate but to a fixed (100V) supply. When gate and drain are tied together, the curve is the boundary separating operation in full enhancement from operation in linear mode (sometimes referred to as "sat mode"). Figure 15 provides an indication of current when operated in short circuit. In the normal range of operation this curve shows a slight negative dependence on temperature and is largely independent from applied voltage.

**The Short-Circuit Withstand Time** (for short-circuit rated IGBTs) defines the guaranteed minimum time the IGBT can be in short circuit in the specified conditions. Notice that the gate resistor cannot be any lower than specified and the overvoltage at turn-off has to be maintained to the indicated value by an appropriate clamp.

If a diode is copackaged with the IGBT, its characteristics are included in this table, together with their associated graphs. The parameters included in the table are defined in application note AN-989.

## 9: The IGBT Families from IR

Table II may be useful in placing different power transistors in the proper perspective. In general, the IGBT offers clear advantages in high voltage (>300V), high current (1-3 A/mm<sup>2</sup> of active area), and medium speed (to 5-50 kHz). International Rectifier's technology is characterized by very low voltage drop per unit of current density. This allows higher levels of minority lifetime killing and, consequently, much lower switching losses.

To maximize the value to the user of its technological breakthrough, International Rectifier has introduced three different families of devices with different crossover frequency: *Standard*, *Fast* and *UltraFast*.

IR's *Standard* IGBTs have been optimized for voltage drop and conduction losses and have the lowest voltage drop per unit of current density that is presently available in the market.

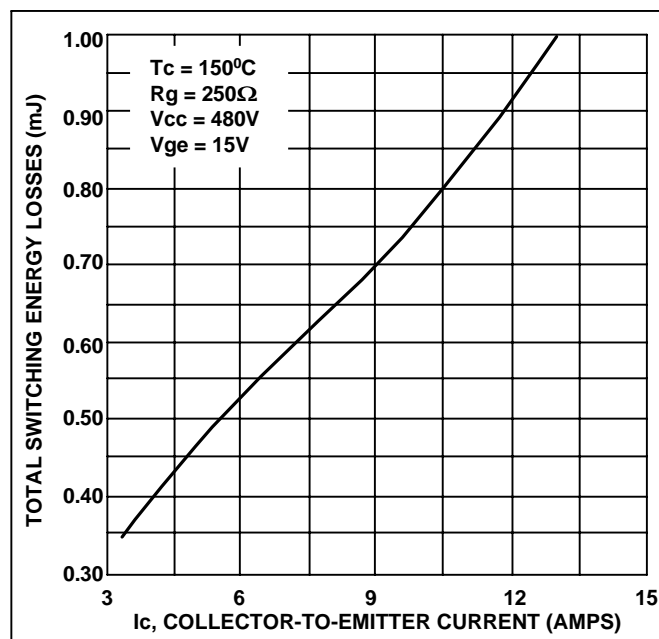
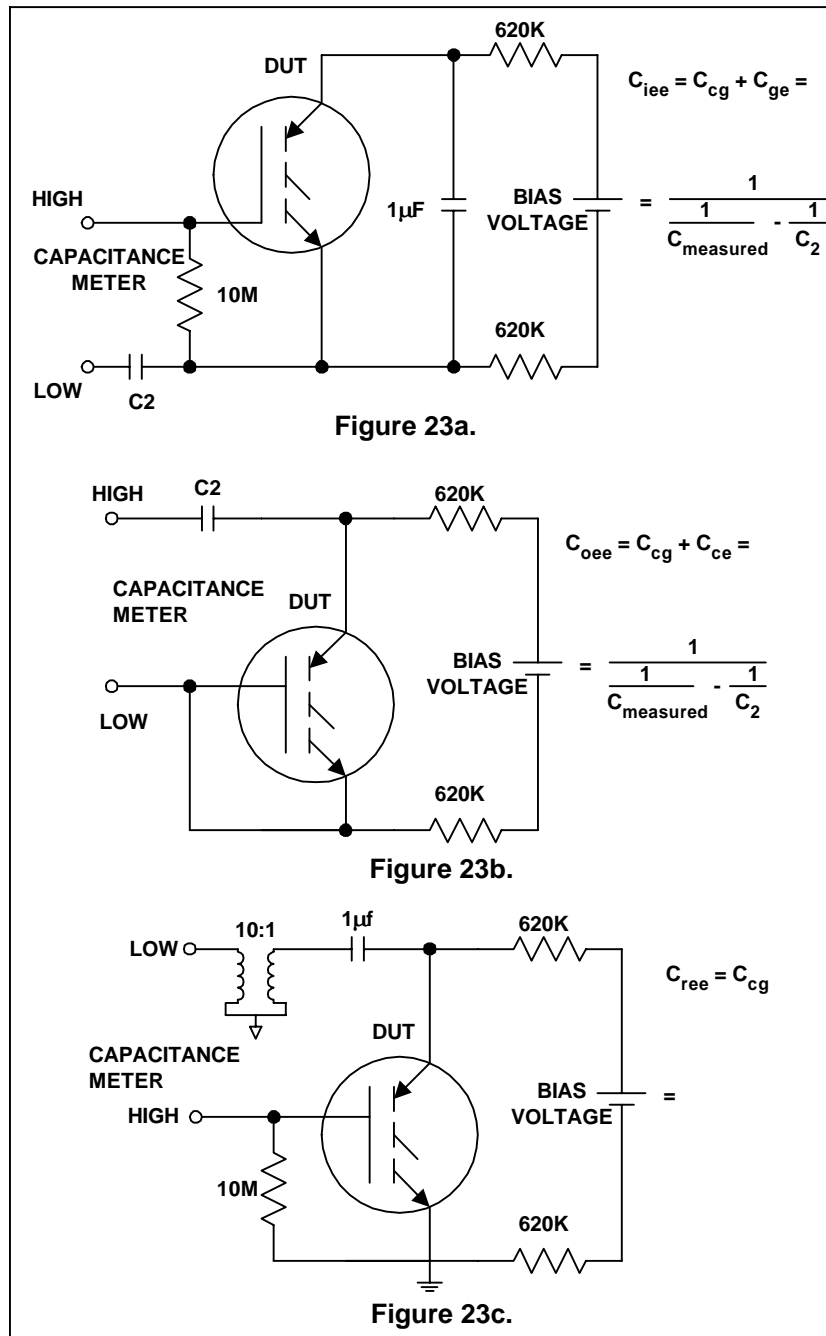

Figure 22. Typical Switching Losses vs. Collector Current

IR's *UltraFast* IGBTs have been optimized for switching losses and have the lowest switching losses per unit of current density presently available in the market.

As it is apparent from Figure 24, these devices have switching speeds that are comparable to those of power MOSFETs in practical applications. They can operate comfortably at 50 kHz in PWM and well over 100 kHz in resonant or ZVS/ZCS circuits.



**Figure 23.** Capacitance test circuits

The IGBT is biased with 25V between collector and emitter. Two of its terminals are ac shorted with a large value capacitor. Capacitance is measured between these two terminals and the third.

IR's *Fast* devices offer a combination of low switching and low conduction losses that closely matches the switching characteristics of many popular bipolar transistors. Table III shows the key features of the three families. The *Fast* and *Ultrafast* IGBTs are also available in short-circuit rated versions for those applications, like motor drives, that require it. The short circuit capability comes at the expenses of a slight increase in conduction losses.

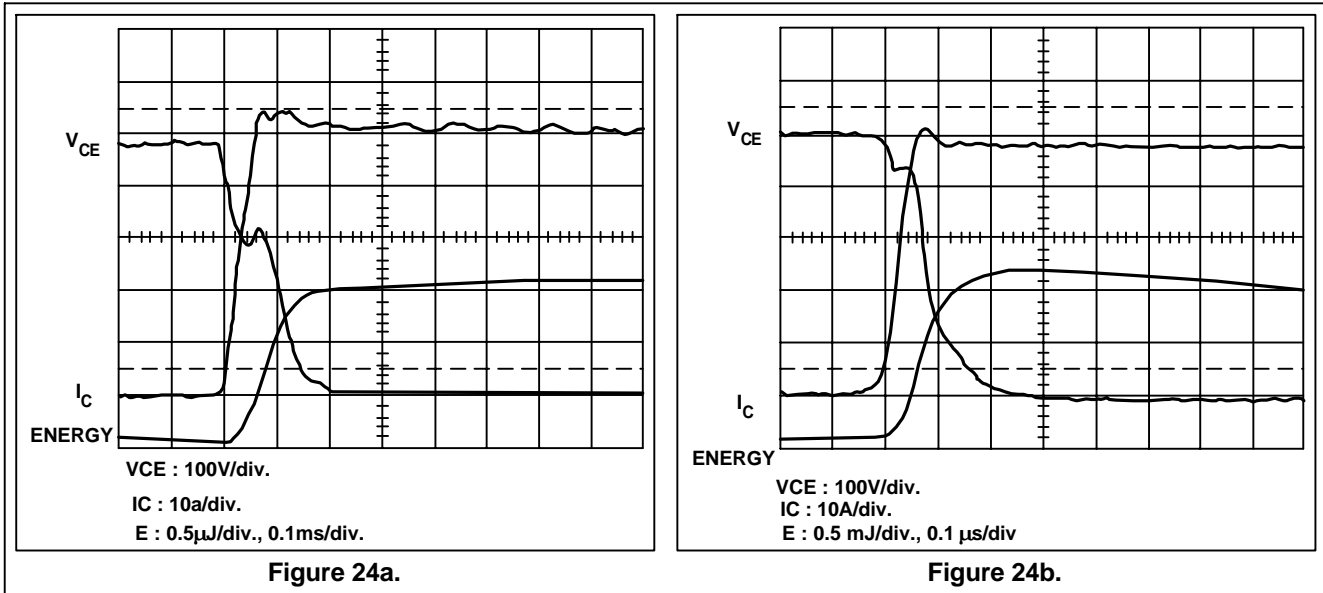

Figure 24. IRGPC50U switching 50A at 480V, 1250C. Test circuit is as shown in Figure 16.

	<b>POWER MOSFETs</b>	<b>IGBTs</b>	<b>Bipolars</b>	<b>Darlingtons</b>
<b>Type of Drive</b>	Voltage	Voltage	Current	Current
<b>Drive Power</b>	Minimal	Minimal	Large	Medium
<b>Drive Complexity</b>	Simple	Simple	High Large positive and negative currents are required	Medium
<b>Current Density For Give Voltage Drop</b>	High at low voltages Low at high voltages	Very High Small trade-off with switching speed	Medium Severe trade-off with switching speed	Low
<b>Switching Losses</b>	Very Low	Low to Medium depending on trade-off with conduction losses	Medium to High depending on trade-off with conduction losses	High

Table II: Comparative Table of Power Transistor Characteristics

*References:*

1. U.S. Patents No. 4,376,286 and 4,642,666

<b>Characteristic</b>	<b>Standard</b>	<b>Fast</b>	<b>Ultrafast</b>
V <sub>CE</sub>	1.3V	1.5V	1.9V
Switching Energy	0.54 mJ/A mm <sup>2</sup>	0.16 mJ/A mm <sup>2</sup>	0.055mJ/A mm <sup>2</sup>
Conduction Losses (50% dc)	0.625W	0.75W	0.95W

Table III. International Rectifier IGBT Families

1A/mm<sup>2</sup>, 100<sup>0</sup>C, Typical Values



International  
**IOR** Rectifier

**WORLD HEADQUARTERS:** 233 Kansas St., El Segundo California 90245, Tel: (310) 322 3331

**EUROPEAN HEADQUARTERS:** Hurst Green, Oxted, Surrey RH8 9BB, UK Tel: ++ 44 1883 732020

**IR CANADA:** 7321 Victoria Park Ave., Suite 201, Markham, Ontario L3R 2Z8, Tel: (905) 475 1897

**IR GERMANY:** Saalburgstrasse 157, 61350 Bad Homburg Tel: ++ 49 6172 96590

**IR ITALY:** Via Liguria 49, 10071 Borgaro, Torino Tel: ++39 11 451 0111

**IR FAR EAST:** K&H Bldg., 2F, 3-30-4 Nishi-Ikeburo 3-Chrome, Toshima-Ki, Tokyo Japan 171 Tel: 81 3 3983 0086

**IR SOUTHEAST ASIA:** 315 Outram Road, #10-02 Tan Boon Liat Building, Singapore 0316 Tel: 65 221 8371

Data and specification subject to change without notice.