



# 6-Pin DIP Zero-Cross Optoisolators Triac Driver Output (400 Volts Peak)

The MOC3041, MOC3042 and MOC3043 devices consist of gallium arsenide infrared emitting diodes optically coupled to a monolithic silicon detector performing the function of a Zero Voltage Crossing bilateral triac driver.

They are designed for use with a triac in the interface of logic systems to equipment powered from 115 Vac lines, such as solid-state relays, industrial controls, motors, solenoids and consumer appliances, etc.

- Simplifies Logic Control of 115 Vac Power
- Zero Voltage Crossing
- dv/dt of 2000 V/μs Typical, 1000 V/μs Guaranteed
- **To order devices that are tested and marked per VDE 0884 requirements, the suffix "V" must be included at end of part number. VDE 0884 is a test option.**

### Recommended for 115/240 Vac(rms) Applications:

- Solenoid/Valve Controls
- Lighting Controls
- Static Power Switches
- AC Motor Drives
- Temperature Controls
- E.M. Contactors
- AC Motor Starters
- Solid State Relays

### MAXIMUM RATINGS (T<sub>A</sub> = 25°C unless otherwise noted)

Rating	Symbol	Value	Unit
--------	--------	-------	------

#### INFRARED EMITTING DIODE

Reverse Voltage	V <sub>R</sub>	6	Volts
Forward Current — Continuous	I <sub>F</sub>	60	mA
Total Power Dissipation @ T <sub>A</sub> = 25°C Negligible Power in Output Driver Derate above 25°C	P <sub>D</sub>	120 1.41	mW mW/°C

#### OUTPUT DRIVER

Off-State Output Terminal Voltage	V <sub>DRM</sub>	400	Volts
Peak Repetitive Surge Current (PW = 100 μs, 120 pps)	I <sub>TSM</sub>	1	A
Total Power Dissipation @ T <sub>A</sub> = 25°C Derate above 25°C	P <sub>D</sub>	150 1.76	mW mW/°C

#### TOTAL DEVICE

Isolation Surge Voltage <sup>(1)</sup> (Peak ac Voltage, 60 Hz, 1 Second Duration)	V <sub>ISO</sub>	7500	Vac(pk)
Total Power Dissipation @ T <sub>A</sub> = 25°C Derate above 25°C	P <sub>D</sub>	250 2.94	mW mW/°C
Junction Temperature Range	T <sub>J</sub>	-40 to +100	°C
Ambient Operating Temperature Range <sup>(2)</sup>	T <sub>A</sub>	-40 to +85	°C
Storage Temperature Range <sup>(2)</sup>	T <sub>stg</sub>	-40 to +150	°C
Soldering Temperature (10 s)	T <sub>L</sub>	260	°C

1. Isolation surge voltage, V<sub>ISO</sub>, is an internal device dielectric breakdown rating.

For this test, Pins 1 and 2 are common, and Pins 4, 5 and 6 are common.

2. Refer to Quality and Reliability Section in Opto Data Book for information on test conditions.

Preferred devices are Motorola recommended choices for future use and best overall value.

GlobalOptoisolator is a trademark of Motorola, Inc.

**(Replaces MOC3040/D)**

**MOC3041**

[IFT = 15 mA Max]

**MOC3042**

[IFT = 10 mA Max]

**MOC3043\***

[IFT = 5 mA Max]

\*Motorola Preferred Device

### STYLE 6 PLASTIC

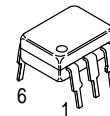

STANDARD THRU HOLE  
CASE 730A-04

### COUPLER SCHEMATIC

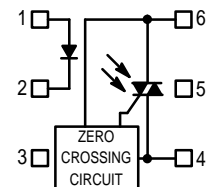

1. ANODE
2. CATHODE
3. NC
4. MAIN TERMINAL
5. SUBSTRATE  
DO NOT CONNECT
6. MAIN TERMINAL

# MOC3041 MOC3042 MOC3043

ELECTRICAL CHARACTERISTICS ( $T_A = 25^\circ\text{C}$  unless otherwise noted)

Characteristic	Symbol	Min	Typ	Max	Unit
----------------	--------	-----	-----	-----	------

## INPUT LED

Reverse Leakage Current ( $V_R = 6\text{ V}$ )	$I_R$	—	0.05	100	$\mu\text{A}$
Forward Voltage ( $I_F = 30\text{ mA}$ )	$V_F$	—	1.3	1.5	Volts

## OUTPUT DETECTOR ( $I_F = 0$ unless otherwise noted)

Leakage with LED Off, Either Direction (Rated $V_{DRM}^{(1)}$ )	$I_{DRM1}$	—	2	100	nA
Peak On-State Voltage, Either Direction ( $I_{TM} = 100\text{ mA Peak}$ )	$V_{TM}$	—	1.8	3	Volts
Critical Rate of Rise of Off-State Voltage <sup>(3)</sup>	dv/dt	1000	2000	—	V/ $\mu\text{s}$

## COUPLED

LED Trigger Current, Current Required to Latch Output (Main Terminal Voltage = 3 V <sup>(2)</sup> )	$I_{FT}$				mA
		MOC3041	—	—	15
		MOC3042	—	—	10
		MOC3043	—	—	5
Holding Current, Either Direction	$I_H$	—	250	—	$\mu\text{A}$
Isolation Voltage ( $f = 60\text{ Hz}$ , $t = 1\text{ sec}$ )	$V_{ISO}$	7500	—	—	Vac(pk)

## ZERO CROSSING

Inhibit Voltage ( $I_F = \text{Rated } I_{FT}$ , MT1–MT2 Voltage above which device will not trigger.)	$V_{IH}$	—	5	20	Volts
Leakage in Inhibited State ( $I_F = \text{Rated } I_{FT}$ , Rated $V_{DRM}$ , Off State)	$I_{DRM2}$	—	—	500	$\mu\text{A}$

1. Test voltage must be applied with dv/dt rating.
2. All devices are guaranteed to trigger at an  $I_F$  value less than or equal to max  $I_{FT}$ . Therefore, recommended operating  $I_F$  lies between  $I_{FT}$  (15 mA for MOC3041, 10 mA for MOC3042, 5 mA for MOC3043) and absolute max  $I_F$  (60 mA).
3. This is static dv/dt. See Figure 7 for test circuit. Commutating dv/dt is a function of the load-driving thyristor(s) only.

## TYPICAL ELECTRICAL CHARACTERISTICS

$T_A = 25^\circ\text{C}$

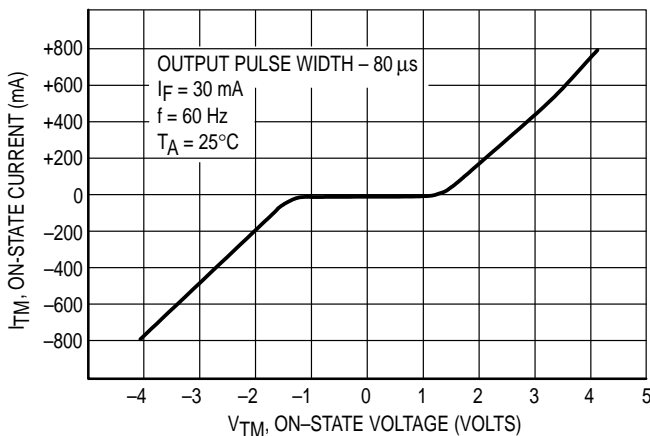

Figure 1. On-State Characteristics

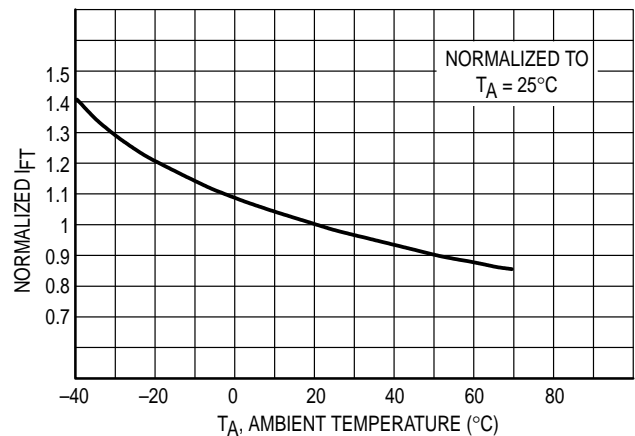

Figure 2. Trigger Current versus Temperature

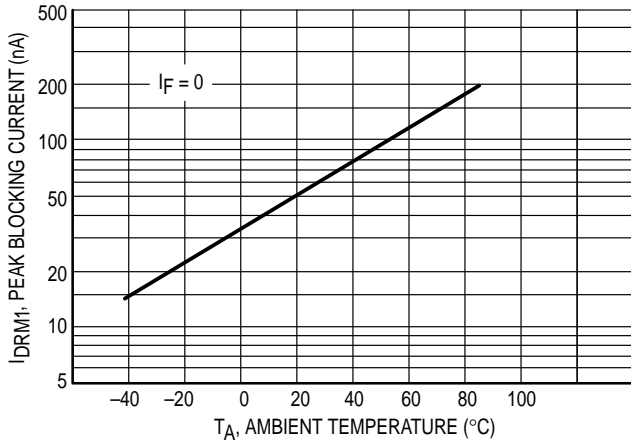

Figure 3.  $I_{DRM1}$ , Peak Blocking Current versus Temperature

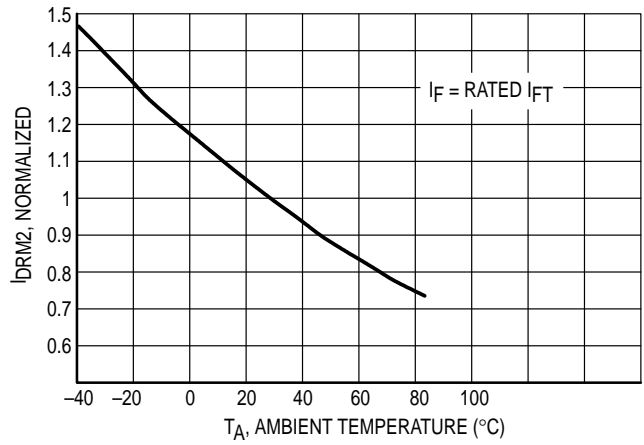

Figure 4.  $I_{DRM2}$ , Leakage in Inhibit State versus Temperature

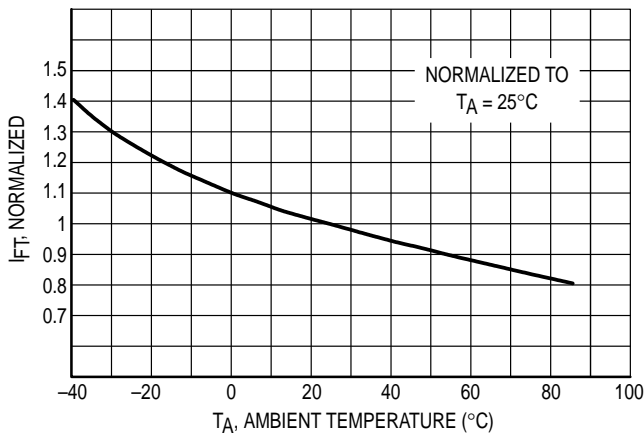

Figure 5. Trigger Current versus Temperature

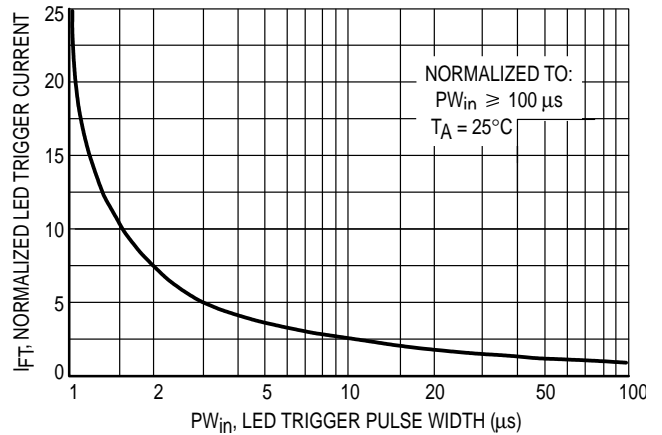
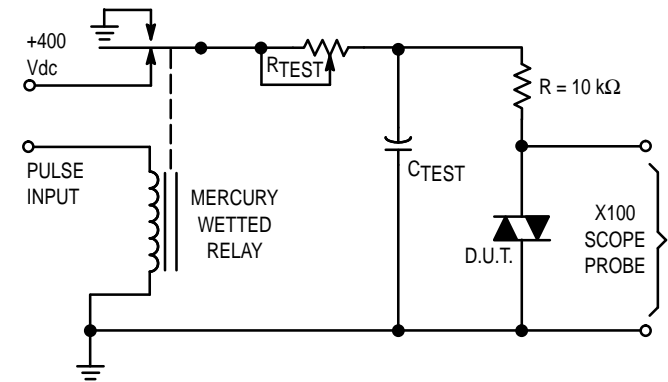

Figure 6. LED Current Required to Trigger versus LED Pulse Width



1. The mercury wetted relay provides a high speed repeated pulse to the D.U.T.
2. 100x scope probes are used, to allow high speeds and voltages.
3. The worst-case condition for static dv/dt is established by triggering the D.U.T. with a normal LED input current, then removing the current. The variable  $R_{TEST}$  allows the dv/dt to be gradually increased until the D.U.T. continues to trigger in response to the applied voltage pulse, even after the LED current has been removed. The dv/dt is then decreased until the D.U.T. stops triggering.  $\tau_{RC}$  is measured at this point and recorded.

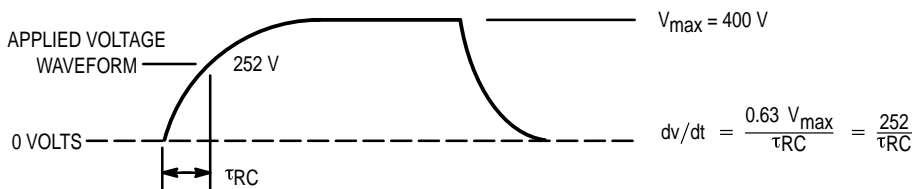
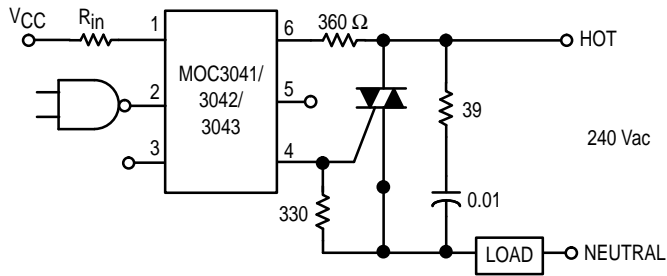

Figure 7. Static dv/dt Test Circuit

## MOC3041 MOC3042 MOC3043



Typical circuit for use when hot line switching is required. In this circuit the "hot" side of the line is switched and the load connected to the cold or neutral side. The load may be connected to either the neutral or hot line.

$R_{in}$  is calculated so that  $I_F$  is equal to the rated  $I_{FT}$  of the part, 5 mA for the MOC3043, 10 mA for the MOC3042, or 15 mA for the MOC3041. The 39 ohm resistor and 0.01  $\mu$ F capacitor are for snubbing of the triac and may or may not be necessary depending upon the particular triac and load used.

\* For highly inductive loads (power factor < 0.5), change this value to 360 ohms.

**Figure 8. Hot-Line Switching Application Circuit**

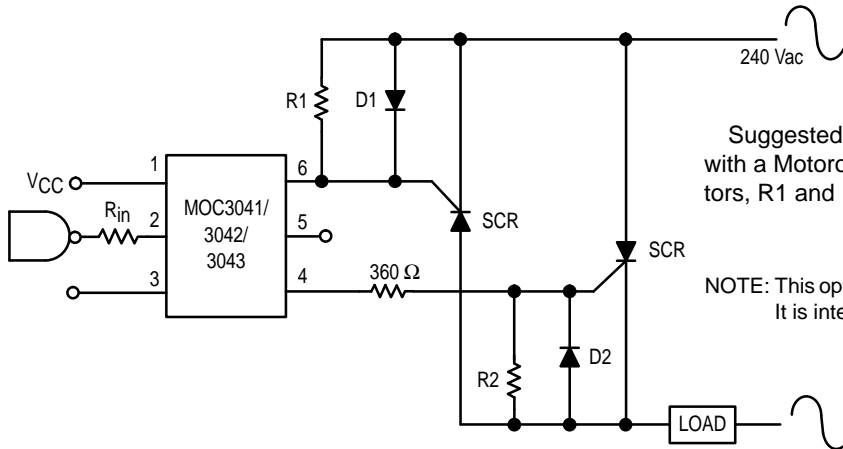

Suggested method of firing two, back-to-back SCR's, with a Motorola triac driver. Diodes can be 1N4001; resistors, R1 and R2, are optional 330 ohms.

NOTE: This optoisolator should not be used to drive a load directly. It is intended to be a trigger device only.

**Figure 9. Inverse-Parallel SCR Driver Circuit**

# MOC3041 MOC3042 MOC3043

## PACKAGE DIMENSIONS

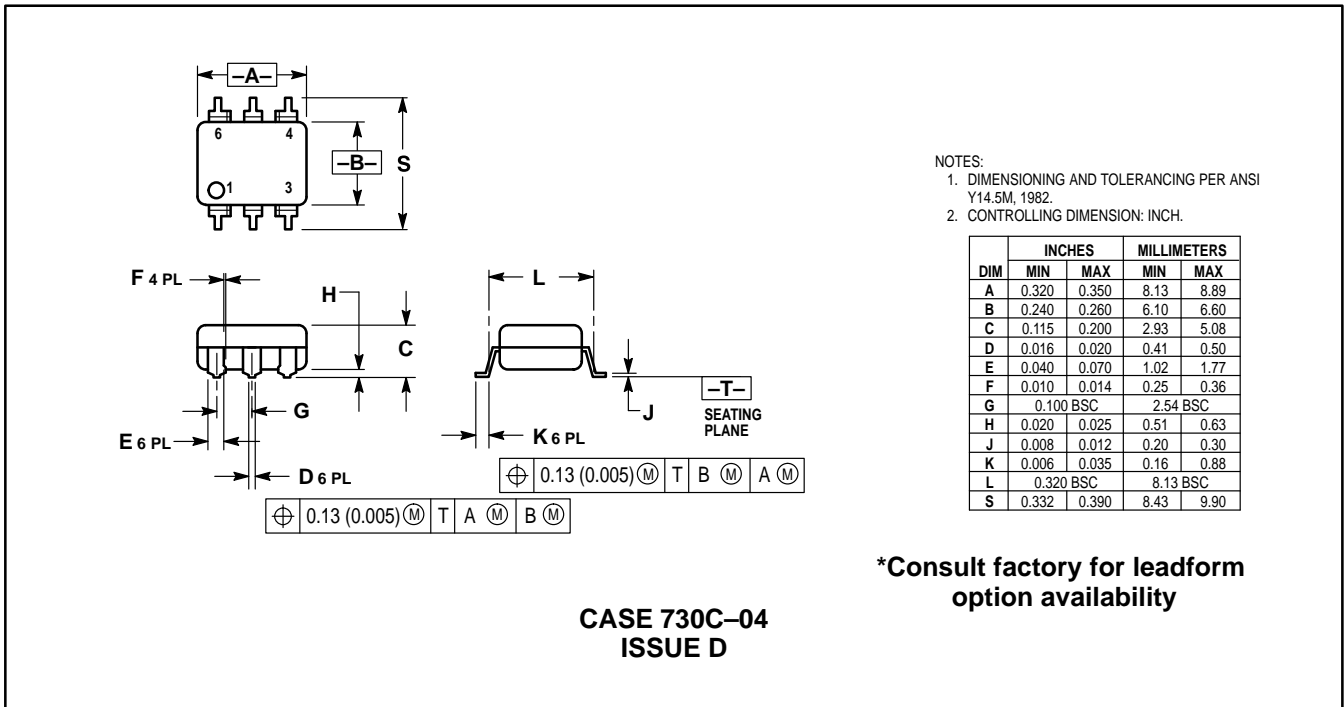
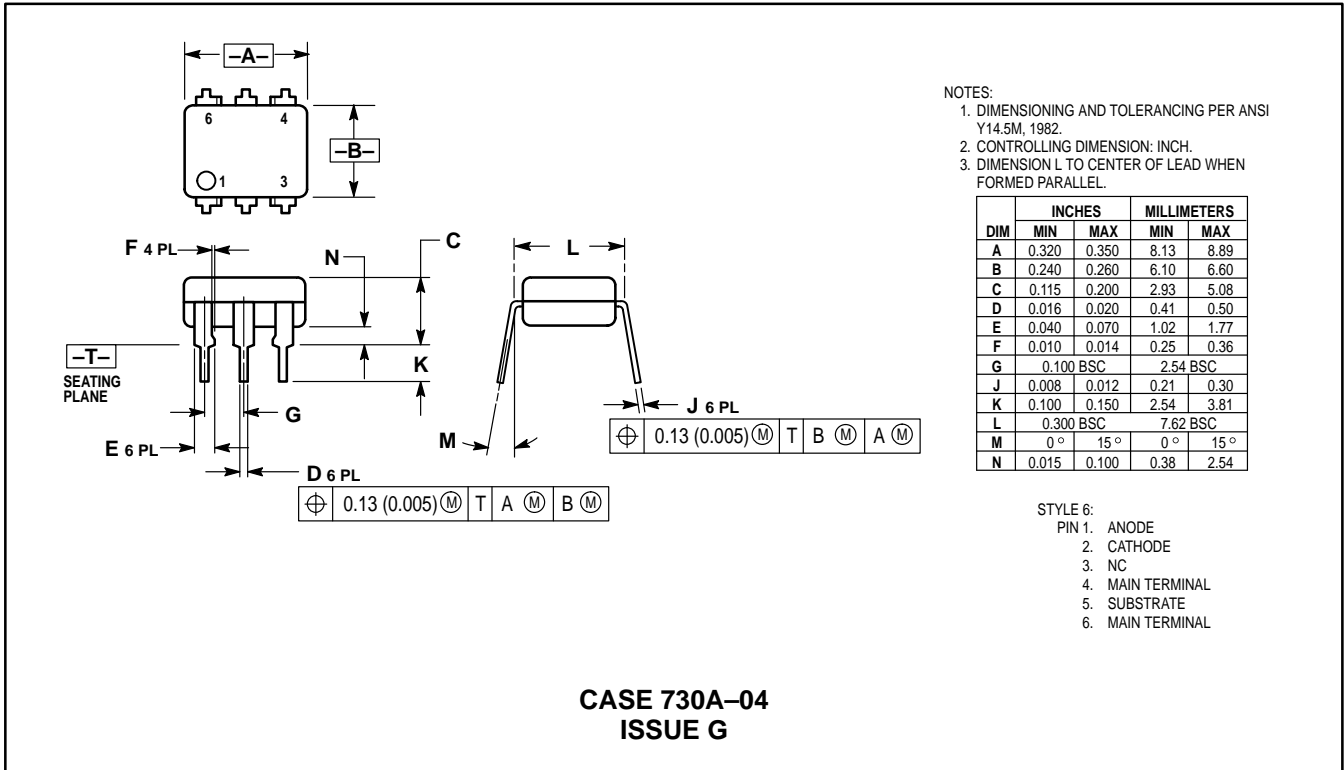

# MOC3041 MOC3042 MOC3043



- NOTES:
1. DIMENSIONING AND TOLERANCING PER ANSI Y14.5M, 1982.
  2. CONTROLLING DIMENSION: INCH.
  3. DIMENSION L TO CENTER OF LEAD WHEN FORMED PARALLEL.

DIM	INCHES		MILLIMETERS	
	MIN	MAX	MIN	MAX
A	0.320	0.350	8.13	8.89
B	0.240	0.260	6.10	6.60
C	0.115	0.200	2.93	5.08
D	0.016	0.020	0.41	0.50
E	0.040	0.070	1.02	1.77
F	0.010	0.014	0.25	0.36
G	0.100 BSC		2.54 BSC	
J	0.008	0.012	0.21	0.30
K	0.100	0.150	2.54	3.81
L	0.400	0.425	10.16	10.80
N	0.015	0.040	0.38	1.02

**\*Consult factory for leadform option availability**

**CASE 730D-05  
ISSUE D**

$\oplus$	0.13 (0.005)	M	T	A	M	B	M
----------	--------------	---	---	---	---	---	---

Motorola reserves the right to make changes without further notice to any products herein. Motorola makes no warranty, representation or guarantee regarding the suitability of its products for any particular purpose, nor does Motorola assume any liability arising out of the application or use of any product or circuit, and specifically disclaims any and all liability, including without limitation consequential or incidental damages. "Typical" parameters can and do vary in different applications. All operating parameters, including "Typicals" must be validated for each customer application by customer's technical experts. Motorola does not convey any license under its patent rights nor the rights of others. Motorola products are not designed, intended, or authorized for use as components in systems intended for surgical implant into the body, or other applications intended to support or sustain life, or for any other application in which the failure of the Motorola product could create a situation where personal injury or death may occur. Should Buyer purchase or use Motorola products for any such unintended or unauthorized application, Buyer shall indemnify and hold Motorola and its officers, employees, subsidiaries, affiliates, and distributors harmless against all claims, costs, damages, and expenses, and reasonable attorney fees arising out of, directly or indirectly, any claim of personal injury or death associated with such unintended or unauthorized use, even if such claim alleges that Motorola was negligent regarding the design or manufacture of the part. Motorola and are registered trademarks of Motorola, Inc. Motorola, Inc. is an Equal Opportunity/Affirmative Action Employer.

**How to reach us:**

**USA / EUROPE:** Motorola Literature Distribution;  
P.O. Box 20912; Phoenix, Arizona 85036. 1-800-441-2447

**JAPAN:** Nippon Motorola Ltd.; Tatsumi-SPD-JLDC, Toshikatsu Otsuki,  
6F Seibu-Butsuryu-Center, 3-14-2 Tatsumi Koto-Ku, Tokyo 135, Japan. 03-3521-8315

**MFAX:** RMFAX0@email.sps.mot.com - TOUCHTONE (602) 244-6609  
**INTERNET:** http://Design-NET.com

**HONG KONG:** Motorola Semiconductors H.K. Ltd.; 8B Tai Ping Industrial Park,  
51 Ting Kok Road, Tai Po, N.T., Hong Kong. 852-26629298

