

Electromagnetic compatibility (EMC) —

Part 3: Limits —

Section 3: Limitation of voltage changes, voltage fluctuations and flicker in public low-voltage supply systems, for equipment with rated current ≤ 16 A per phase and not subject to conditional connection

The European Standard EN 61000-3-3:1995, with the incorporation of amendment A1:2001, has the status of a British Standard

ICS 33.100

NO COPYING WITHOUT BSI PERMISSION EXCEPT AS PERMITTED BY COPYRIGHT LAW



Committees responsible for this British Standard

The preparation of this British Standard was entrusted by Technical Committee GEL/110, Electromagnetic compatibility, to Subcommittee GEL/110/8, Electromagnetic compatibility — Low frequency disturbances, upon which the following bodies were represented:

Association of Control Manufacturers — TACMA (BEAMA Ltd.)
 Association of Manufacturers of Domestic Electrical Appliances
 BEAMA Ltd.
 British Lighting Association for the Preparation of Standards (BRITLAPS)
 British Radio and Electronic Equipment Manufacturers' Association
 British Telecommunications plc
 Building Automation and Mains Signalling Association (BAMSA)
 (BEAMA Ltd.)
 Electrical Contractors' Association
 Electrical Installation Equipment Manufacturers' Association (BEAMA Ltd.)
 Electricity Association
 ERA Technology Ltd.
 Federation of the Electronics Industry
 GAMBICA (BEAMA Ltd.)
 Heating, Ventilating and Air Conditioning Association
 Institution of Electrical Engineers
 Lighting Industry Federation Ltd.
 Power Supply Manufacturers' Association — PSMA (BEAMA Ltd.)
 Professional Lighting and Sound Association
 Sound and Communications Industries Federation
 Radiocommunications Agency

This British Standard, having been prepared under the direction of the Electrotechnical Sector Board, was published under the authority of the Standards Board and comes into effect on 15 August 1995

© BSI 2 April 2002

The following BSI references relate to the work on this standard:
 Committee reference GEL/110/8
 Draft for comment 90/28296 DC

ISBN 0 580 24181 5

Amendments issued since publication

Amd. No.	Date	Comments
9789	January 1998	Addition to National foreword regarding the EN foreword.
13568	2 April 2002	See National foreword, and change to title of standard.

Contents

	Page
Committees responsible	Inside front cover
National foreword	ii
Foreword	2
Text of EN 61000-3-3	5

National foreword

This part of BS EN 61000 has been prepared by Subcommittee GEL/110/8 and is the English language version of EN 61000-3-3:1995, *Electromagnetic compatibility (EMC) — Part 3: Limits — Section 3: Limitation of voltage changes, voltage fluctuations and flicker in public low-voltage supply systems, for equipment with rated current ≤ 16 A per phase and not subject to conditional connection*, including amendment A1:2001, published by the European Committee for Electrotechnical Standardization (CENELEC). It is identical with IEC 61000-3-3:1994, including amendment 1:2001, published by the International Electrotechnical Commission (IEC).

IEC 61000 has been designated a Basic EMC publication for use in the preparation of dedicated product, product family and generic EMC standards.

The foreword of the EN makes reference to the “date of withdrawal”, (dow) of the relevant national standard. In this case the relevant national standard is BS 5406-3:1988 as amended by amendment No 1:1992 which will be withdrawn on 2001-01-01.

The start and finish of text introduced or altered by amendment is indicated in the text by tags **A1** **A1**. Tags indicating changes to IEC text carry the number of the IEC amendment. For example, text altered by IEC amendment 1 is indicated by **A1** **A1**.

Cross-references

The British Standards which implement international or European publications referred to in this document may be found in the BSI Standards Catalogue under the section entitled “International Standards Correspondence Index”, or by using the “Find” facility of the BSI Standards Electronic Catalogue.

A British Standard does not purport to include all the necessary provisions of a contract. Users of British Standards are responsible for their correct application.

Compliance with a British Standard does not of itself confer immunity from legal obligations.

Summary of pages

This document comprises a front cover, an inside front cover, pages i and ii, the EN title page, pages 2 to 25 and a back cover.

The BSI copyright notice displayed in this document indicates when the document was last issued.

English version

**Electromagnetic compatibility (EMC) —
Part 3: Limits —
Section 3: Limitation of voltage changes, voltage
fluctuations and flicker in public low-voltage supply
systems, for equipment with rated current ≤ 16 A per phase
and not subject to conditional connection**

(includes amendment A1:2001)

(IEC 61000-3-3:1994)

Compatibilité électromagnétique (CEM) —
Partie 3: Limites —
Section 3: Limitation des variations de tension,
des fluctuations de tension et du papillotement
dans les réseaux publics d'alimentation basse
tension ayant un courant assigné ≤ 16 A par
phase et non soumis à un raccordement
conditionnel
(inclut l'amendement A1:2001)
(CEI 61000-3-3:1994)

Elektromagnetische Verträglichkeit (EMV) —
Teil 3: Grenzwerte —
Hauptabschnitt 3: Begrenzung von
Spannungsänderungen
Spannungsschwankungen und Flicker in
öffentlichen Niederspannungs-
Versorgungsnetzen für Geräte mit einem
Bemessungsstrom ≤ 16 A je Leiter, die keiner
Sonderanschlussbedingung unterliegen
(enthält Änderung A1:2001)
(IEC 61000-3-3:1994)

This European Standard was approved by CENELEC on 1994-03-08. CENELEC members are bound to comply with the CEN/CENELEC Internal Regulations which stipulate the conditions for giving this European Standard the status of a national standard without any alteration.

Up-to-date lists and bibliographical references concerning such national standards may be obtained on application to the Central Secretariat or to any CENELEC member.

This European Standard exists in three official versions (English, French, German). A version in any other language made by translation under the responsibility of a CENELEC member into its own language and notified to the Central Secretariat has the same status as the official versions.

CENELEC members are the national electrotechnical committees of Austria, Belgium, Denmark, Finland, France, Germany, Greece, Iceland, Ireland, Italy, Luxembourg, Netherlands, Norway, Portugal, Spain, Sweden, Switzerland and United Kingdom.

CENELEC

European Committee for Electrotechnical Standardization
Comité Européen de Normalisation Electrotechnique
Europäisches Komitee für Elektrotechnische Normung

Central Secretariat: rue de Stassart 35, B-1050 Brussels

Foreword

The text of document 77A(CO)38, future edition 1 of IEC 61000-3-3:1994, prepared by SC 77A, Low-frequency phenomena, of IEC TC 77, Electromagnetic compatibility, was submitted to the IEC-CENELEC parallel vote and was approved by CENELEC as EN 61000-3-3 on 1994-03-08.

This European Standard supersedes EN 60555-3:1987 + A1:1991.

The following dates were fixed:

- latest date by which the EN has to be implemented at national level by publication of an identical national standard or by endorsement (dop) 1995-07-01
- latest date by which the national standards conflicting with the EN have to be withdrawn (dow) 2001-01-01

Annexes designated “normative” are part of the body of the standard. In this standard, Annex A and Annex ZA are normative. Annex ZA has been added by CENELEC.

Foreword to amendment A1

The text of document 77A/326/FDIS, future amendment 1 to IEC 61000-3-3:1994, prepared by SC 77A, Low-frequency phenomena, of IEC TC 77, Electromagnetic compatibility, was submitted to the IEC-CENELEC parallel vote and was approved by CENELEC as amendment A1 to EN 61000-3-3:1995 on 2001-05-01.

The following dates were fixed:

- latest date by which the amendment has to be implemented at national level by publication of an identical national standard or by endorsement (dop) 2002-02-01
- latest date by which the national standards conflicting with the amendment have to be withdrawn (dow) 2004-05-01

Annexes designated “normative” are part of the body of the standard. In this standard, Annex A, Annex B and Annex ZA are normative. Annex ZA has been added by CENELEC.

Contents

	Page
Foreword	2
Introduction	5
1 Scope	5
2 Normative references	6
3 Definitions	6
3.1 R.M.S. voltage shape, $U(t)$	6
3.2 voltage change characteristic, $\Delta U(t)$	6
3.3 maximum voltage change, ΔU_{max}	6
3.4 steady-state voltage change, ΔU_c	7
3.5 voltage fluctuation	7
3.6 flicker	7
3.7 short-term flicker indicator, P_{st}	7
3.8 long-term flicker indicator, P_{lt}	7
3.9 flickermeter	7
3.10 flicker impression time, t_f	7
4 Assessment of voltage changes, voltage fluctuations and flicker	8
4.1 Assessment of relative voltage change, “ d ”	8
4.2 Assessment of the short-term flicker value, P_{st}	8
4.2.1 Flickermeter	8
4.2.2 Simulation method	8
4.2.3 Analytical method	9
4.2.3.1 Description of the analytical method	9
4.2.3.2 Shape factor	9
4.2.4 Use of $P_{st} = 1$ curve	9
4.3 Assessment of long-term flicker value, P_{lt}	9
5 Limits	10
6 Test conditions	10
6.1 General	10
6.2 Measurement accuracy	11
6.3 Test supply voltage	11
6.4 Reference impedance	11
6.5 Observation period	11
6.6 General test conditions	12
Annex A (normative) Application of limits and type test conditions for specific equipment	19
Annex B (normative) Test conditions and procedures for measuring d_{max} voltage changes caused by manual switching	24
Annex ZA (normative) Other international publications quoted in this standard with the references of the relevant European publications	25

	Page
Figure 1 — Reference network for single-phase and three-phase supplies derived from a three-phase, four-wire supply	13
Figure 2 — Histogram evaluation of $U(t)$	14
Figure 3 — Relative voltage change characteristic	14
Figure 4 — Curve for $P_{st} = 1$ for rectangular equidistant voltage changes	15
Figure 5 — Shape factors F for double-step and ramp-voltage characteristics	16
Figure 6 — Shape factors F for rectangular and triangular voltage characteristics	17
Figure 7 — Shape factors F for motor-start voltage characteristics having various front times	18
Table 1 — Assessment method	8
Table A.1 — Electrode parameters	22
Table A.2 — Frequency factor R related to repetition rate $\langle a \rangle$	23

Introduction

IEC 61000 is published in separate parts according to the following structure:

- *Part 1: General — General considerations (introduction, fundamental principles) — Definitions, terminology;*
- *Part 2: Environment — Description of the environment — Classification of the environment — Compatibility levels;*
- *Part 3: Limits — Emission limits — Immunity limits (in so far as they do not fall under the responsibility of product committees);*
- *Part 4: Testing and measurement techniques — Measurement techniques — Testing techniques;*
- *Part 5: Installation and mitigation guidelines — Installation guidelines — Mitigation methods and devices;*
- *Part 9: Miscellaneous.*

Each part is further subdivided into sections which are to be published either as International Standards or as Technical Reports.

These standards and reports will be published in chronological order and numbered accordingly.

This **A1** part **A1** is a Product Family Standard.

A1 The limits in this standard relate to the voltage changes experienced by consumers connected at the interface between the public supply low-voltage network and the equipment user's installation. Consequently, if the actual impedance of the supply at the supply terminals of equipment connected within the equipment user's installation exceeds the test impedance, it is possible that supply disturbance exceeding the limits may occur. **A1**

1 Scope

This **A1** part of IEC 61000 **A1** is concerned with the limitation of voltage fluctuations and flicker impressed on the public low-voltage system.

It specifies limits of voltage changes which may be produced by an equipment tested under specified conditions and gives guidance on methods of assessment.

A1 This part of IEC 61000 is applicable to electrical and electronic equipment having an input current equal to or less than 16 A per phase, intended to be connected to public low-voltage distribution systems of between 220 V and 250 V line to neutral at 50 Hz, and not subject to conditional connection.

Equipment which does not comply with the limits of this part of IEC 61000 when tested with the reference impedance Z_{ref} of 6.4, and which therefore cannot be declared compliant with this part, may be retested or evaluated to show conformity with IEC 61000-3-11. Part 3-11 is applicable to equipment with rated input current ≤ 75 A per phase and subject to conditional connection. **A1**

The tests according to this **A1** part **A1** are type tests. Particular test conditions are given in Annex A and the test circuit is shown in Figure 1.

A1 NOTE The limits in this part of IEC 61000 are based mainly on the subjective severity of flicker imposed on the light from 230 V/60 W coiled-coil filament lamps by fluctuations of the supply voltage. For systems with nominal voltage less than 220 V line to neutral and/or frequency of 60 Hz, the limits and reference circuit values are under consideration. **A1**

2 Normative references

The following normative documents contain provisions which, through reference in this text, constitute provisions of this International Standard. At the time of publication, the editions indicated were valid. All normative documents are subject to revision, and parties to agreements based on this International Standard are encouraged to investigate the possibility of applying the most recent editions of the normative documents indicated below. Members of the IEC and the ISO maintain registers of currently valid International Standards.

IEC 60050(161):1990, *International Electrotechnical Vocabulary (IEV) — Chapter 161: Electromagnetic compatibility*.

Ⓐ¹⁾

Ⓐ¹⁾

IEC 60335-2-11:1993, *Safety of household and similar electrical appliances — Part 2: Particular requirements for tumbler dryers*.

IEC 60725:1981, *Considerations on reference impedances for use in determining the disturbance characteristics of household appliances and similar electrical equipment*.

IEC 60868:1986, *Flickermeter — Functional and design specifications*. Amendment No. 1 (1990)¹⁾.

Ⓐ¹⁾ IEC 60974-1, *Arc welding equipment — Part 1: Welding power sources*. Ⓐ¹⁾

Ⓐ¹⁾ IEC 61000-3-2, *Electromagnetic compatibility (EMC) — Part 3-2: Limits — Limits for harmonic current emissions (equipment input current ≤ 16 A per phase)*. Ⓐ¹⁾

IEC 61000-3-5:1994, *Electromagnetic compatibility (EMC) — Part 3: Limits — Section 5: Limitation of voltage changes, voltage fluctuations and flicker in public low-voltage supply systems, for equipment with rated current greater than 16 A per phase and not subject to conditional connection*.

Ⓐ¹⁾ IEC 61000-3-11, *Electromagnetic compatibility (EMC) — Part 3-11: Limits — Limitation of voltage changes, voltage fluctuations and flicker in public low-voltage supply systems — Equipment with rated current ≤ 75 A and subject to conditional connection*. Ⓐ¹⁾

3 Definitions

For the purpose of this Ⓐ¹⁾ part Ⓐ¹⁾ of IEC 61000-3, the following definitions apply.

3.1

r.m.s. voltage shape, $U(t)$

Ⓐ¹⁾ the time function of the r.m.s. voltage, evaluated as a single value for each successive half period between zero-crossings or the source voltage (see Figure 2) Ⓐ¹⁾

3.2

voltage change characteristic, $\Delta U(t)$

Ⓐ¹⁾ the time function of the r.m.s. voltage change evaluated as a single value for each successive half period between zero-crossings of the source voltage between time intervals in which the voltage is in a steady-state condition for at least 1 s (see Figure 2)

NOTE Since this characteristic is only used for assessments using calculations, the voltage in the steady-state condition is assumed to be constant within the measurement accuracy (see 6.2). Ⓐ¹⁾

3.3

maximum voltage change characteristic, ΔU_{\max}

Ⓐ¹⁾ the difference between maximum and minimum r.m.s. values of a voltage change characteristic (see Figure 2) Ⓐ¹⁾

¹⁾ Ⓐ¹⁾ IEC 60868 will be withdrawn and replaced by IEC 61000-4-15 in 2003. Flickermeter complying with IEC 61000-4-15 may also be used for flicker measurements associated with this part of IEC 61000-3. Ⓐ¹⁾

3.4

steady-state voltage change, ΔU_c

the difference between two adjacent steady-state voltages separated by at least one voltage change characteristic (see Figure 2)

NOTE Definitions 3.2, 3.3 and 3.4 relate to absolute phase-to-neutral voltages. The ratios of these magnitudes to the phase-to-neutral value of the nominal voltage (U_n) of the reference network in Figure 1 are called:

- relative voltage change characteristic: $d(l)$ (definition 3.2);
- maximum relative voltage change: d_{\max} (definition 3.3);
- relative steady-state voltage change: d_c (definition 3.4).

These definitions are explained by the example in Figure 3.

3.5

voltage fluctuation

A1 series of changes of r.m.s voltage evaluated as a single value for each successive half-period between zero-crossings of the source voltage **A1**

3.6

flicker

impression of unsteadiness of visual sensation induced by a light stimulus whose luminance or spectral distribution fluctuates with time [IEV 161-08-13]

3.7

short-term flicker indicator, P_{st}

the flicker severity evaluated over a short period (in minutes); $P_{st} = 1$ is the conventional threshold of irritability

3.8

long-term flicker indicator, P_{lt}

the flicker severity evaluated over a long period (a few hours) using successive P_{st} values

3.9

flickermeter

an instrument designed to measure any quantity representative of flicker

NOTE Measurements are normally P_{st} and P_{lt} . [IEV 161-08-14]

3.10

flicker impression time, t_f

A1 value with a time dimension which describes the flicker impression of a voltage change characteristic

3.11

conditional connection

connection of equipment requiring the user's supply at the interface point to have an impedance lower than the reference impedance Z_{ref} in order that the equipment emissions comply with the limits in this part

NOTE Meeting the voltage change limits may not be the only condition for connection; emission limits for other phenomena such as harmonics, may also have to be satisfied.

3.12

interface point

interface between a public supply network and a user's installation **A1**

4 Assessment of \overline{U} voltage changes, \overline{U}_f voltage fluctuations and flicker

4.1 Assessment of \overline{U} voltage fluctuations and flicker \overline{U}_f

The basis for flicker evaluation is the voltage change waveform at the terminals of the equipment under test, that is the difference ΔU of any two successive values of the phase-to-neutral voltages $U(t_1)$ and $U(t_2)$:

$$\Delta U = U(t_1) - U(t_2) \tag{1}$$

The r.m.s. values $U(t_1)$, $U(t_2)$ of the voltage shall be measured or calculated. When deducing r.m.s. values from oscillographic \overline{U} characteristic \overline{U}_f , account should be taken of any waveform distortion that may be present. The voltage change ΔU is due to the change of the voltage drop across the complex reference impedance Z , caused by the complex fundamental input current change, ΔI , of the equipment under test. ΔI_p and ΔI_q are the active and reactive parts respectively of the current change, ΔI .

$$\Delta I = \Delta I_p - j \cdot \Delta I_q = I(t_1) - I(t_2) \tag{2}$$

NOTE 1 I_q is positive for lagging currents and negative for leading currents.

NOTE 2 If the harmonic distortion of the currents $I(t_1)$ and $I(t_2)$ is less than 10 %, the total r.m.s. value may be applied instead of the r.m.s. values of their fundamental currents.

NOTE 3 \overline{U} For single-phase and symmetrical three-phase equipment the voltage change can, provided X is positive (inductive), be approximated to: \overline{U}_f

$$\Delta U = |\Delta I_p \cdot R + \Delta I_q \cdot X| \tag{3}$$

where

ΔI_p and ΔI_q are the active and reactive parts respectively of the current change ΔI ;

R and X are the elements of the complex reference impedance Z (see Figure 1).

The relative voltage change is given by:

$$\sigma = \Delta U / U_n \tag{4}$$

4.2 Assessment of the short-term flicker value, P_{st}

The short-term flicker value P_{st} is defined in amendment 1 to IEC 60868.

Table 1 shows alternative methods for evaluating P_{st} , due to voltage fluctuations of different types.

Table 1 — Assessment method

Types of voltage fluctuations	Methods of evaluating P_{st}
All voltage fluctuations (on-line evaluation)	Direct measurement
All voltage fluctuations where $U(t)$ is defined	Simulation Direct measurement
Voltage change \overline{U} characteristics \overline{U}_f according to Figure 5, Figure 6 and Figure 7 with an occurrence rate less than 1 per second	Analytical method Simulation Direct measurement
Rectangular voltage changes at equal intervals	Use of the $P_{st} = 1$ curve of Figure 4

4.2.1 Flickermeter

All types of voltage fluctuations may be assessed by direct measurement using a flickermeter which complies with the specification given in IEC 60868, and is connected as described in clause 6 of this section. This is the reference method for application of the limits.

4.2.2 Simulation method

In the case where the relative voltage change \overline{U} characteristic $\overline{U}_f d(t)$ is known, P_{st} can be evaluated using a computer simulation.

4.2.3 Analytical method

For voltage change $\square A_1$ characteristics $\square A_1$ of the types shown in Figure 5, Figure 6 and Figure 7, the P_{st} value can be evaluated by an analytical method using equations (5) and (6).

NOTE 1 The value of P_{st} obtained using this method is expected to be within $\pm 10\%$ of the result which would be obtained by direct measurement (reference method).

NOTE 2 This method is not recommended if the time duration between the end of one voltage change and the start of the next is less than 1 s.

4.2.3.1 Description of the analytical method

Each relative voltage change $\square A_1$ characteristic $\square A_1$ shall be expressed by a flicker impression time, t_f , in seconds:

$$t_f = 2,3 (F \cdot d_{\max})^{3,2} \quad (5)$$

— the maximum relative voltage change d_{\max} is expressed as a percentage of the nominal voltage;

— the shape factor, F , is associated with the shape of the voltage change $\square A_1$ characteristic $\square A_1$ (see 4.2.3.2).

The sum of the flicker impression times, Σt_f , of all evaluation periods within a total interval of the length T_p , in seconds, is the basis for the P_{st} evaluation. If the total time interval T_p is chosen according to 6.5, it is an “observation period”, and:

$$P_{st} = (\Sigma t_f / T_p)^{1/3,2} \quad (6)$$

4.2.3.2 Shape factor

The shape factor, F , converts a relative voltage change $\square A_1$ characteristic $\square A_1 d(t)$ into a flicker equivalent relative step voltage change ($F \cdot d_{\max}$).

NOTE 1 The shape factor, F , is equal to 1,0 for step voltage changes.

NOTE 2 The relative voltage change $\square A_1$ characteristic $\square A_1$ may be measured directly (see Figure 1) or calculated from the r.m.s. current of the equipment under test [see equations (1) to (4)].

$\square A_1$ The relative voltage change characteristic shall be obtained from a histogram of $U(t)$ (see Figure 3). $\square A_1$

The shape factor may be deduced from Figure 5, Figure 6 and Figure 7, provided that the relative voltage change $\square A_1$ characteristic $\square A_1$ matches a characteristic shown in the figures. If the $\square A_1$ characteristics $\square A_1$ match, proceed as follows:

— find the maximum relative voltage change d_{\max} (according to Figure 3); and

— find the time T (ms) appropriate to the voltage change $\square A_1$ characteristic $\square A_1$ as shown in Figure 5, Figure 6 and Figure 7 and, using this value, obtain the required shape factor, F .

NOTE 3 Extrapolation outside the range of the figures may lead to unacceptable errors.

4.2.4 Use of $P_{st} = 1$ curve

In the case of rectangular voltage changes of the same amplitude “ d ” separated by equal time intervals, the curve of Figure 4 may be used to deduce the amplitude corresponding to $P_{st} = 1$ for a particular rate of repetition; this amplitude is called d_{lim} . The P_{st} value corresponding to the voltage change “ d ” is then given by $P_{st} = d/d_{lim}$.

4.3 Assessment of long-term flicker value, P_{lt}

The long-term flicker value P_{lt} is defined in IEC 60868, Appendix A.2, and shall be applied with the value of $N = 12$ (see 6.5).

It is generally necessary to assess the value of P_{lt} for equipment which is normally operated for more than 30 min at a time.

5 Limits

A1) The limits shall be applicable to voltage fluctuations and flicker at the supply terminals of the equipment under test, measured or calculated according to clause 4 under test conditions described in clause 6 and Annex A. Tests made to prove the compliance with the limits are considered to be type tests.

The following limits apply:

- the value of P_{st} shall not be greater than 1,0;
- the value of P_{1t} shall not be greater than 0,65;
- the value of $d(t)$ during a voltage change shall not exceed 3,3 % for more than 500 ms;
- the relative steady-state voltage change, d_{cs} , shall not exceed 3,3 %;
- the maximum relative voltage change, d_{max} , shall not exceed;
 - a) 4 % without additional conditions;
 - b) 6 % for equipment which is:
 - switched manually, or
 - switched automatically more frequently than twice per day, and also has either a delayed restart (the delay being not less than a few tens of seconds), or manual restart, after a power supply interruption.

NOTE The cycling frequency will be further limited by the P_{st} and P_{1t} limit. For example: a d_{max} of 6 % producing a rectangular voltage change characteristic twice per hour will give a P_{1t} of about 0,65.

- c) 7 % for equipment which is:
 - attended whilst in use (for example: hair dryers, vacuum cleaners, kitchen equipment such as mixers, garden equipment such as lawn mowers, portable tools such as electric drills), or
 - switched on automatically, or is intended to be switched on manually, no more than twice per day, and also has either a delayed restart (the delay being not less than a few tens of seconds) or manual restart, after a power supply interruption.

In the case of equipment having several separately controlled circuits in accordance with 6.6, limits b) and c) shall apply only if there is delayed or manual restart after a power supply interruption; or all equipment with automatic switching which is energized immediately on restoration of supply after a power supply interruption, limits a) shall apply; for all equipment with manual switching, limits b) or c) shall apply depending on the rate of switching.

P_{st} and P_{1t} requirements shall not be applied to voltage changes caused by manual switching.

The limits shall not be applied to voltage changes associated with emergency switching or emergency interruptions. **A1)**

6 Test conditions

6.1 General

Tests **A1)** need **A1)** not be made on equipment which is unlikely to produce significant voltage fluctuations or flicker.

A1) It may be necessary to determine, by examination of the circuit diagram and specification of the equipment and by a short functional test, whether significant voltage fluctuations are likely to be produced.

For voltage changes caused by manual switching, equipment is deemed to comply without further testing if the maximum r.m.s. input current (including inrush current) evaluated over each 10 ms half-period between zero-crossings does not exceed 20 A, and the supply current after inrush is within a variation band of 1,5 A.

If measurement methods are used, the maximum relative voltage change d_{max} caused by manual switching shall be measured in accordance with Annex B. **A1)**

Tests to prove the compliance of the equipment with the limits shall be made using the test circuit in Figure 1.

The test circuit consists of:

- the test supply voltage (see 6.3);
- the reference impedance (see 6.4);
- the equipment under test (see Annex A);
- if necessary, a flickermeter (see IEC 60868).

The relative voltage change $d(t)$ may be measured directly or derived from the r.m.s. current as described in 4.1. To determine the P_{st} value of the equipment under test, one of the methods described in 4.2 shall be used. In case of doubt, the P_{st} shall be measured using the reference method with a flickermeter.

NOTE If balanced multiphase equipment is tested, it is acceptable to measure only one of the three line-to-neutral voltages.

6.2 Measurement accuracy

The magnitude of the current shall be measured with an accuracy of $\pm 1\%$ or better. If instead of active and reactive current the phase angle is used, its error shall not exceed $\pm 2^\circ$.

The relative voltage change “ d ” shall be determined with a total accuracy better than $\pm 8\%$ with reference to the maximum value d_{max} . The total impedance of the circuit, excluding the appliance under test, but including the internal impedance of the supply source, shall be equal to the reference impedance. The stability and tolerance of this total impedance shall be adequate to ensure that the overall accuracy of $\pm 8\%$ is achieved during the whole assessment procedure.

NOTE The following method is not recommended where the measured values are close to the limits.

When the source impedance is not well defined, for example where the source impedance is subject to unredictable variations, an impedance having resistance and inductance equal to the reference impedance may be connected between the supply and the terminals of the equipment under test. Measurements can then be made of the voltages at the source side of the reference impedance and at the equipment terminals. In that case, the maximum relative voltage change, d_{max} , measured at the supply terminals shall be less than 20 % of the maximum value d_{max} measured at the equipment terminals.

6.3 Test supply voltage

The test supply voltage (open-circuit voltage) shall be the rated voltage of the equipment. If a voltage range is stipulated for the equipment, the test voltage shall be 230 V single-phase or 400 V three-phase. The test voltage shall be maintained within $\pm 2\%$ of the nominal value. The frequency shall be 50 Hz $\pm 0,5\%$.

The percentage total harmonic distortion of the supply voltage shall be less than 3 %.

Fluctuations of the test supply voltage during a test may be neglected if the P_{st} value is less than 0,4. This condition shall be verified before and after each test.

6.4 Reference impedance

For equipment under test the reference impedance, Z_{ref} , according to IEC 60725, is a conventional impedance used in the calculation and measurement of the relative voltage change “ d ”, and the P_{st} and P_{lt} values.

The impedance values of the various elements are given in Figure 1.

6.5 Observation period

The observation period, T_p , for the assessment of flicker values by flicker measurement, flicker simulation, or analytical method shall be:

- for P_{st} , $T_p = 10$ min;
- for P_{lt} , $T_p = 2$ h.

The observation period shall include that part of the whole operation cycle in which the equipment under test produces the most unfavourable sequence of voltage changes.

For the assessment of P_{st} , the cycle of operation shall be repeated continuously, unless stated otherwise in Annex A. The minimum time to restart the equipment shall be included in this observation period when testing equipment that stops automatically at the end of a cycle of operation which lasts for less than the observation period.

For P_{It} assessment, the cycle of operation shall not be repeated, unless stated otherwise in Annex A, when testing equipment with a cycle of operation of less than 2 h and which is not normally used continuously.

NOTE For example, in the case of equipment with a cycle of operation lasting 45 min, five consecutive P_{st} values will be measured during a total period of 50 min, and the remaining seven P_{st} values in the 2 h observation period will be deemed to be zero.

6.6 General test conditions

The test conditions for the measurement of voltage fluctuations and flicker are given below. For equipment not mentioned in Annex A, controls or automatic program shall be set to produce the most unfavourable sequence of voltage changes, using only those combinations of controls and programmes which are mentioned by the manufacturer in the instruction manual, or are otherwise likely to be used. Particular test conditions for equipment not included in Annex A are under consideration.

The equipment shall be tested in the condition in which it is supplied by the manufacturer. Preliminary operation of motor drives may be needed before the tests to ensure that results corresponding to those of normal use are obtained.

(A) NOTE Operating conditions include mechanical and/or electrical loading conditions. **(A)**

For motors, locked-rotor measurements may be used to determine the largest r.m.s. voltage change, d_{max} , occurring during motor starting.

For equipment having several separately controlled circuits, the following conditions apply:

- each circuit shall be considered as a single item of equipment if it is intended to be used independently, provided that the controls are not designed to switch at the same instant;
- if the control of separate circuits are designed to switch simultaneously, the group of circuits so controlled are considered as a single item of equipment.

For control systems regulating part of a load only, the voltage fluctuations produced by each variable part of the load alone shall be considered.

Detailed type test conditions for some equipment are given in Annex A.

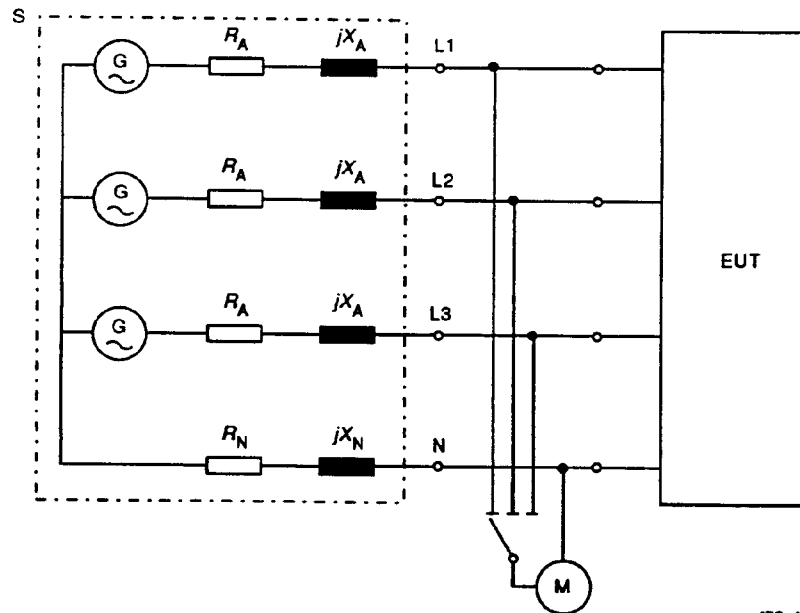

IEC 103594

EUT equipment under test

M measuring equipment

S supply source consisting of the supply voltage generator **G** and reference impedance **Z** with the elements:

$$R_A = 0,24 \Omega; \quad jX_A = 0,15 \Omega \text{ at } 50 \text{ Hz};$$

$$R_N = 0,16 \Omega; \quad jX_N = 0,10 \Omega \text{ at } 50 \text{ Hz}.$$

The elements include the actual generator impedance.

When the source impedance is not well defined, see 6.2.

G voltage source in accordance with 6.3.

NOTE In general, three-phase loads are balanced, and R_N and X_N can be neglected, as there is no current in the neutral wire.

Figure 1 — Reference network for single-phase and three-phase supplies derived from a three-phase, four-wire supply

A1)

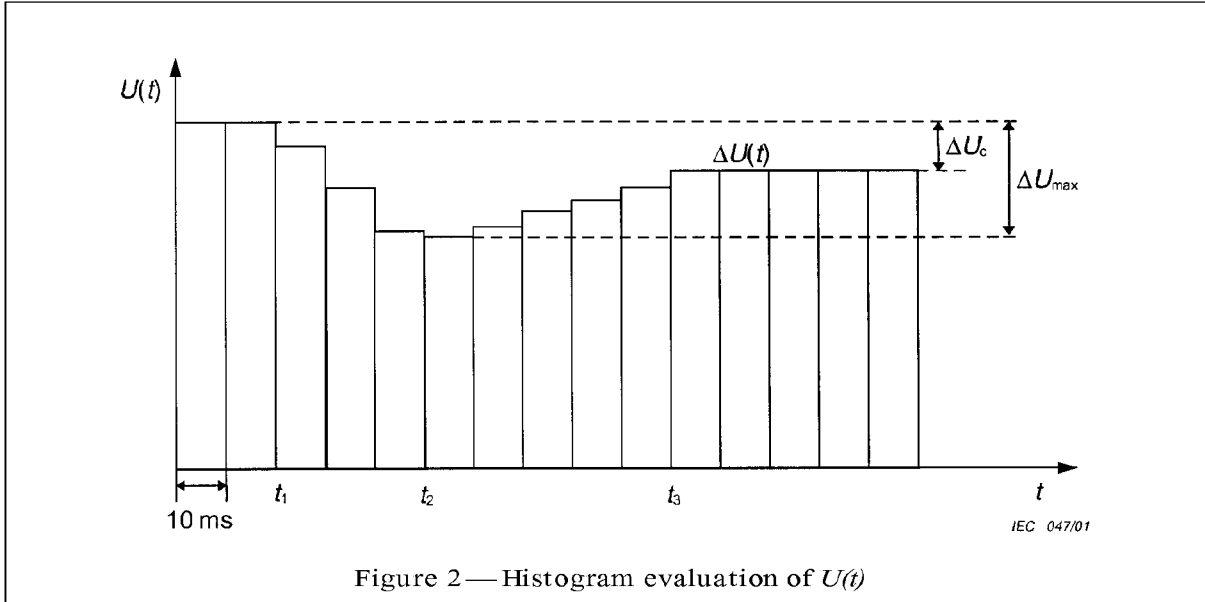

Figure 2—Histogram evaluation of $U(t)$

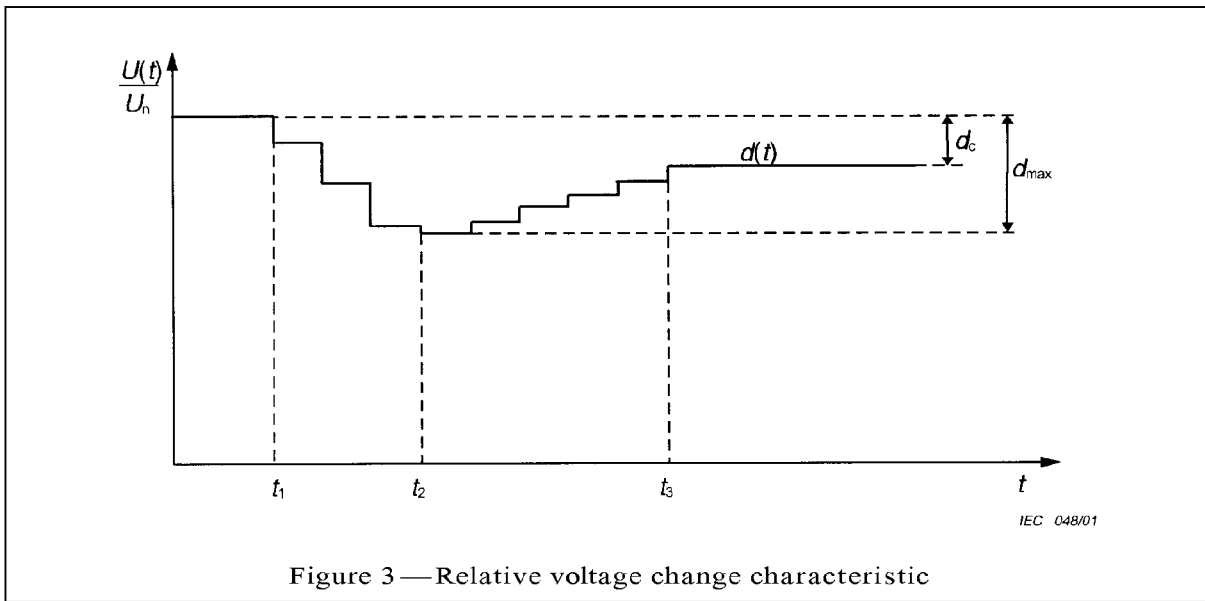
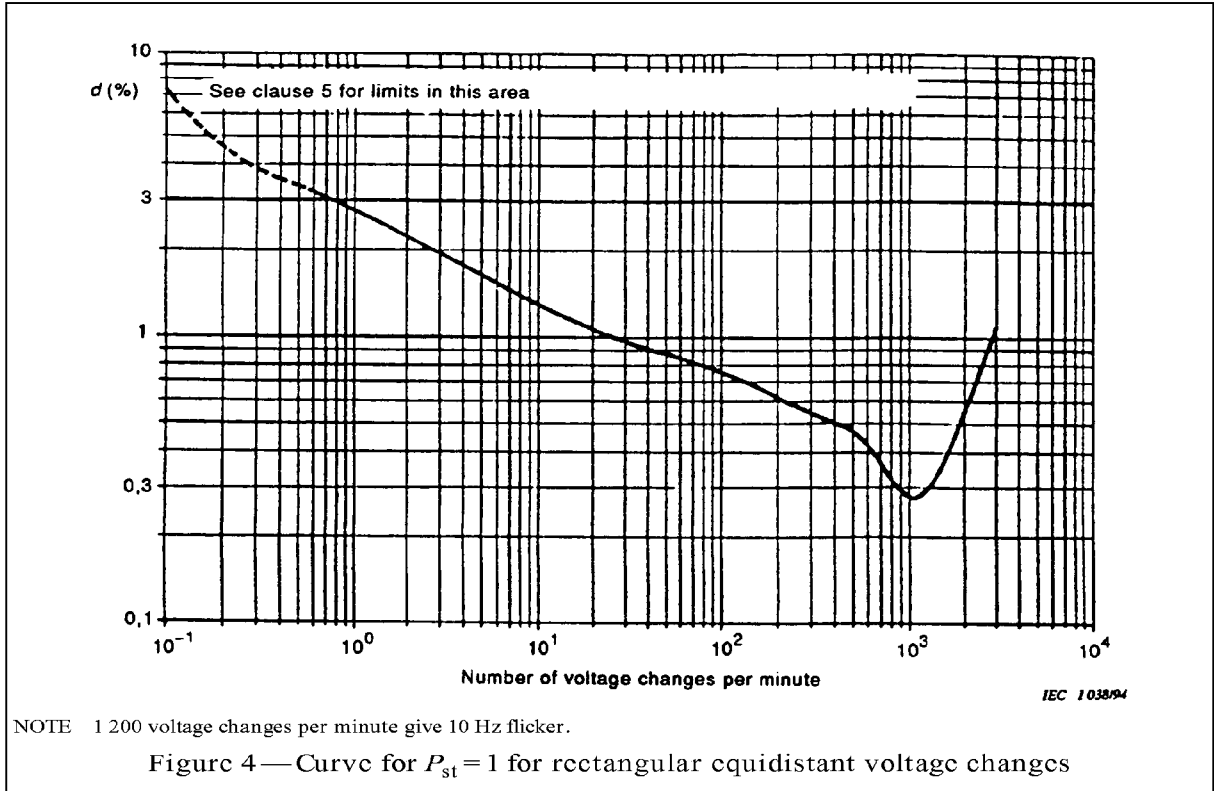

Figure 3—Relative voltage change characteristic

A1)



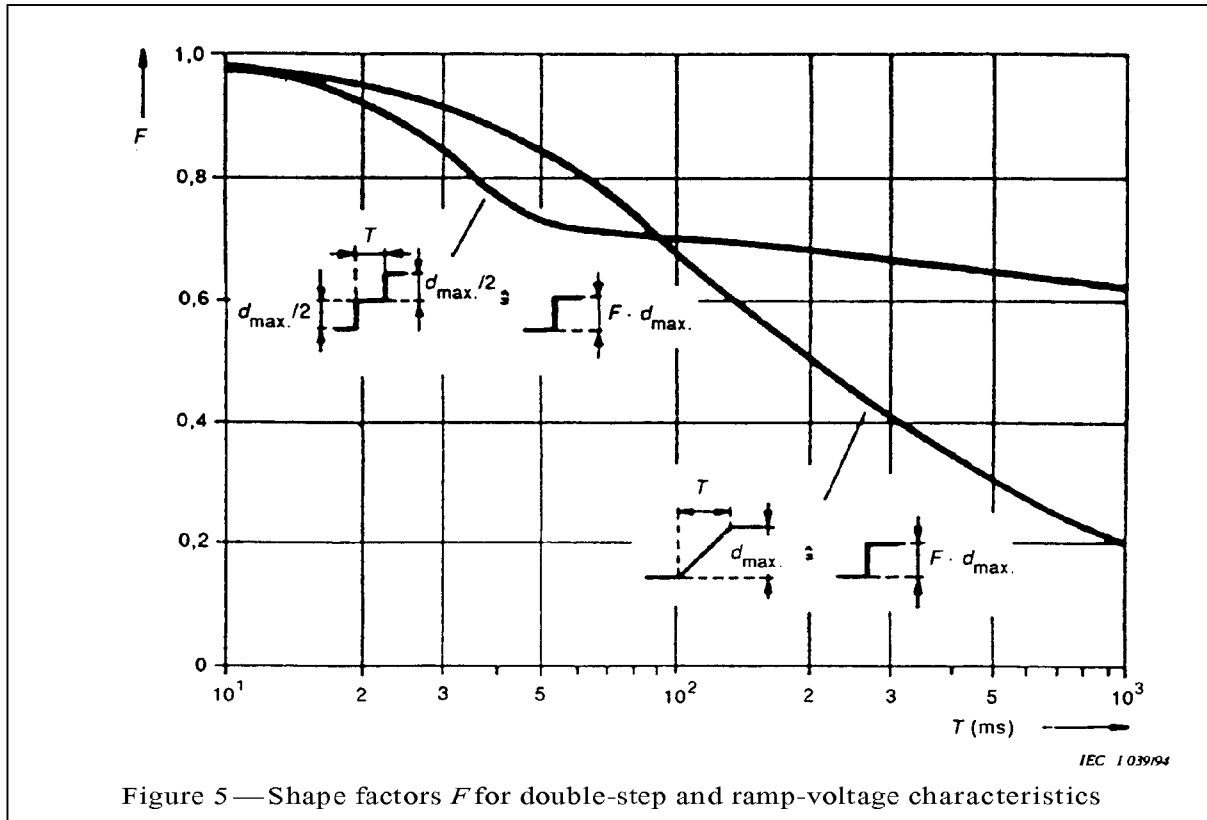

Figure 5 — Shape factors F for double-step and ramp-voltage characteristics

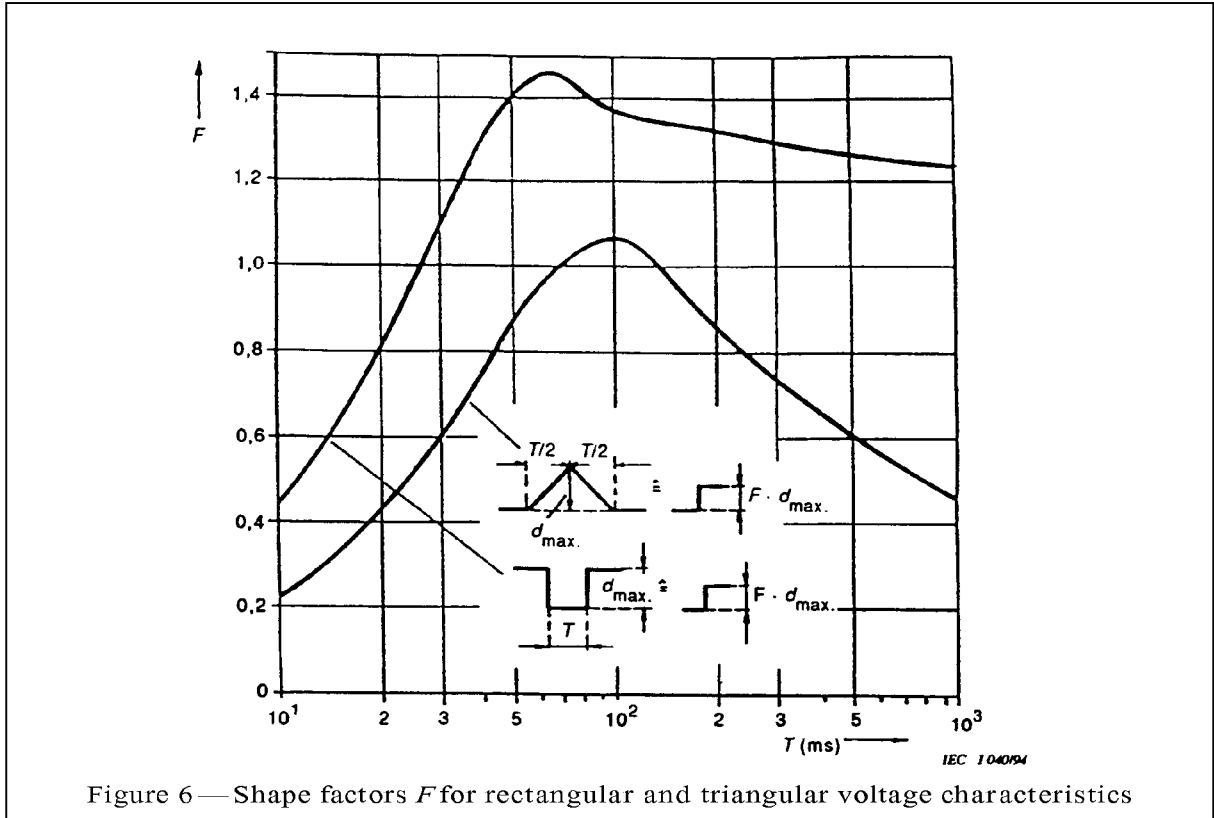
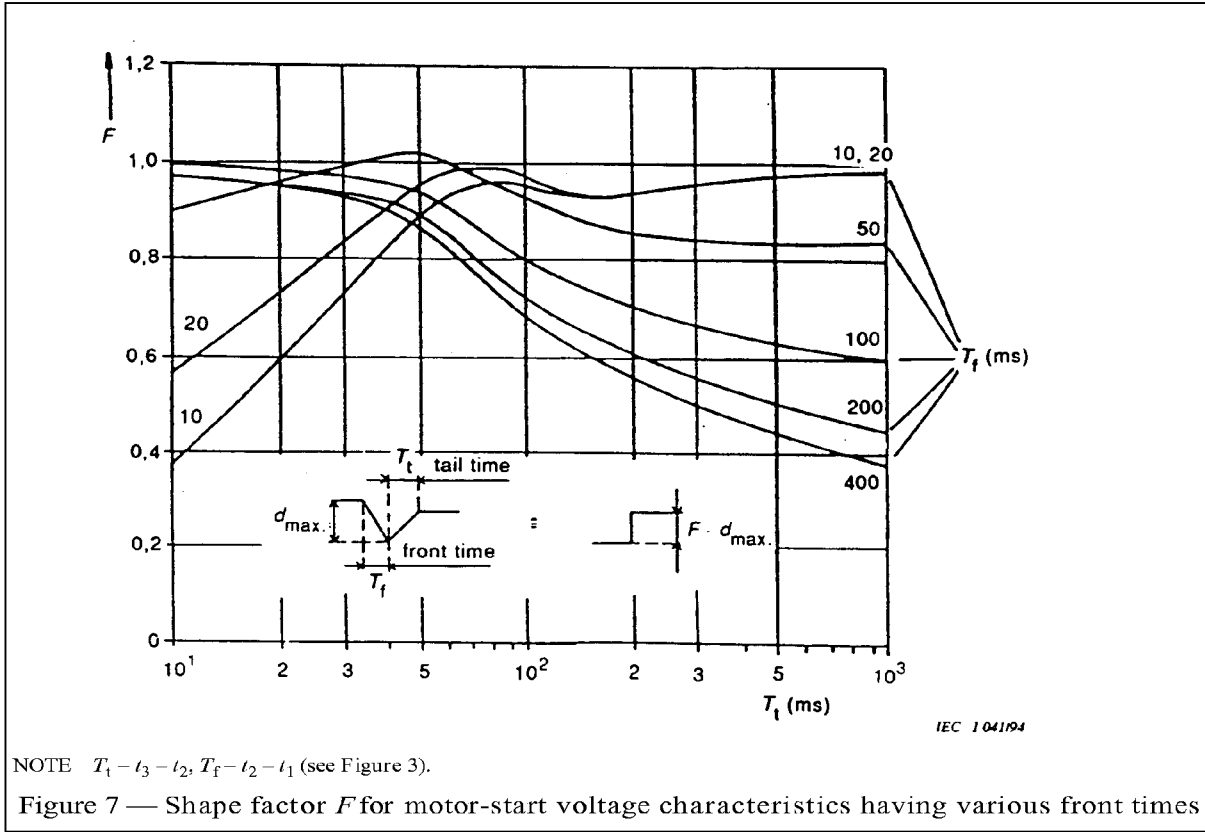

Figure 6—Shape factors F for rectangular and triangular voltage characteristics



Annex A (normative)

Application of limits and type test conditions for specific equipment

A.1 Test conditions for cookers

For cookers designed for use in domestic premises, the evaluation of P_{1t} shall not be required.

The tests of P_{st} shall be performed at steady-state temperature conditions, unless stated otherwise.

Each heater shall be tested separately as follows.

A.1.1 Hotplates

Hotplates shall be tested using standard saucepans with diameter, height and water quantity as follows:

Diameter of the hotplate (mm)	Height of the pot (mm)	Quantity of water (g)
145	about 140	1 000 ± 50
180	about 140	1 500 ± 50
220	about 120	2 000 ± 50

Possible losses by evaporation have to be compensated for during the time of measurement.

In all of the following tests the hotplate shall comply with the limits given in clause 5.

- Boiling temperature range: set the control to the position where the water just boils. The test is made five times and the mean value of the test results calculated.
- Frying temperature range: fill the pot, without a lid, with silicone oil to 1,5 times the quantity of water shown in the table. Set the control to a temperature of 180 °C measured by a thermocouple in the geometric centre of the oil.
- Total range of power settings: the total power range shall be checked continuously during a 10 min observation period. If control switches have discrete stages, test all stages up to a maximum of 20 stages. If there are no discrete stages, divide the total range into 10 equally spaced steps. The measurements shall then be made starting at the highest power stage.

A.1.2 Baking ovens

The oven shall be tested empty with the door closed. Adjust the control so that a thermocouple fixed in the geometric centre measures a mean temperature of 220 °C for conventional ovens and 200 °C for hot air oven.

A.1.3 Grills

The grill shall be tested empty with the door closed, if not otherwise stated by the manufacturer. If a control is available it shall be set to the lowest, the medium and the highest setting for grilling operation; and the worst result recorded.

A.1.4 Baking oven/grill combinations

The oven/grill combination shall be tested empty with the door closed. Adjust the control so that a thermocouple fixed in the geometric centre measures a mean temperature of 250 °C, or that available temperature closest to this value.

A.1.5 Microwave ovens

The microwave oven or the microwave function of a combination oven shall be tested at the lowest, the medium and a third stage which is the highest adjustable power less than or equal to 90 % of the maximum power. Load the oven with a glass bowl containing 1 000 ± 50 g of water.

A1)

A.2 Test conditions for lighting and similar equipment

The following test conditions shall apply to equipment with a primary function of generating and/or regulating and/or distributing optical radiation by means of incandescent or discharge lamps or LEDs.

Such equipment shall be tested with a lamp of that power for which the equipment is rated. If lighting equipment includes more than one lamp, all lamps shall be in use.

P_{st} and P_{lt} evaluations are required only for lighting equipment which is likely to produce flicker; for example: disco lighting and automatically regulated equipment.

No limits shall apply to lamps.

Incandescent lamp luminaires with ratings less than or equal to 1 000 W and discharge lamp luminaires with ratings less than or equal to 600 W, are deemed to comply with the d_{max} limits in this standard are not required to be tested. Luminaires with higher ratings, which cannot comply with the part of IEC 61000, shall be subject to conditional connection in accordance with IEC 61000-3-11.

Ballasts are deemed to be part of luminaires and are not required to be tested. A1)

A.3 Test conditions for washing machines

A1) The washing machine shall be tested during a complete laundry programme incorporating the normal wash-cycle filled with the rated load of double hemmed, pre-washed cotton cloths, size approximately:

70 cm × 70 cm, dry weight from 140 g/m² to 175 g/m².

The temperature of the fill water shall be:

- 65 °C ± 5 °C for washing machines without heater elements;
- 15 °C ± 5 °C for other washing machines.

For washing machines with a programmer, the 60 °C cotton programme without pre-wash shall be used.

If the washing machines does not incorporate a programmer, the water is heated to 90 °C ± 5 °C or lower if steady conditions are established, before starting the first wash period. A1)

Neglect simultaneous switching of heater and motor in the evaluation of d_c , d_{max} and $d(t)$.

P_{st} and P_{lt} shall be evaluated.

A.4 Test conditions for tumbler dryers

The tumbler dryer shall be filled with 50 % of the load as specified for normal operation in IEC 60335-2-11.

If a control of the drying degree is available, the test shall be performed at the maximum and minimum settings.

P_{st} and P_{lt} shall be evaluated.

A.5 Test conditions for refrigerators

Refrigerators shall operate continuously with the door closed. Adjust the thermostat to the mid-value of the adjusting range. The cabinet shall be empty and not heated. The measurement shall be made after a steady state has been reached. P_{st} and P_{lt} shall not be evaluated.

A.6 Test conditions for copying machines, laser printers and similar appliances

The appliance shall be tested for P_{st} at the maximum rate of copying. The original to be copied/printed is white blank paper and the copy paper shall have a weight of 80 g/m² if not otherwise stated by the manufacturer.

Obtain the P_{lt} value in the stand-by mode.

A.7 Test conditions for vacuum cleaners

For vacuum cleaners, P_{st} and P_{lt} shall not be evaluated.

A.8 Test conditions for food mixers

For food mixers, P_{st} and P_{lt} shall not be evaluated.

A.9 Test conditions for portable tools

For portable tools, P_{lt} shall not be evaluated. For portable tools without heating elements, P_{st} shall not be evaluated. For portable tools with heating elements, P_{st} shall be evaluated as follows.

Switch on the tool and allow to operate continuously for 10 min, or until it switches off automatically, in which case 6.5 applies.

A.10 Test conditions for hairdryers

For hand-held hairdryers, P_{lt} shall not be evaluated. To evaluate P_{st} , switch on the hairdryer and allow to operate continuously for 10 min or until it switches off automatically, in which case 6.5 applies.

For hairdryers incorporating a power range, check the total power range continuously during a 10 min observation period. If control switches have discrete stages all stages shall be tested up to a maximum of 20 stages. If there are no discrete stages, divide the total range into 10 equally spaced steps. The measurements shall then be made, starting with the highest power stage.

A.11 Test conditions for consumer electronics products

For consumer electronics products, only the measurement of d_{max} is made.

A.12 Test conditions for direct water heaters

For direct water heaters without electronic controls, evaluate d_c only by switching the heater on and off (sequence 0 – P_{max} – 0).

For direct water heaters with electronic controls, the output temperature of the water has to be chosen so that by means of the variation of water flow-rate all electric power consumption rates between P_{min} and P_{max} may be produced. P_{max} is defined as the maximum power which can be chosen, and $P_{min} > 0$ is defined as the minimum power which can be chosen.

NOTE For some appliances, the maximum power P_{max} which can be chosen may be less than the rated power.

The set temperature value shall be kept unchanged during the total test.

Starting from the water flow-rate demand for maximum power consumption, P_{max} , reduce the rate of flow in 20 approximately equal steps to minimum power consumption, P_{min} .

Then, in another 20 approximately equal steps, increase the water flow-rate again to power consumption P_{max} . For each of these 40 stages the $P_{st,i}$ value shall be evaluated; the measurements start when the steady state is reached, that is about 30 s after changing the water flow-rate.

NOTE It may be sufficient to calculate $P_{st,i}$ value on the base of a measurement period of only 1 min.

Additionally, the flicker $P_{st,z}$ caused by switching the heater on and off has to be measured within a 10 min interval. In this interval, the power consumption has to be changed twice in the quickest possible way between the stages $P = 0$ and $P = P_{max}$ (sequence 0 – P_{max} – 0 – P_{max} – 0).

The duty cycle of the heater shall be 50 % that is P_{max} during 5 min.

Evaluate the resultant P_{st} values by:

$$P_{st} = \left(P_{st,z}^3 + \frac{1}{40} \sum_{i=1}^{i=40} (P_{st,i})^3 \right)^{\frac{1}{3}}$$

and compare against the limit value in clause 5.

P_{lt} shall not be evaluated.

A)

A.13 Test conditions for audio-frequency amplifiers

Audio amplifiers shall be tested under the same operating conditions as are specified in clause C.3 of IEC 61000-3-2.

A.14 Test conditions for air conditioners, dehumidifiers, heat pumps, and commercial refrigerating equipment

Operate the equipment until a steady-state condition has been established or for a minimum compressor run time of 30 min.

The ambient temperature for testing shall be 15 °C ± 5 °C for heating and 30 °C ± 5 °C for cooling or dehumidification.

Reverse cycle heat pumps shall be tested only in cooling mode.

d_{\max} shall be evaluated in one of the following ways:

a) by direct measurement:

- turn the motor of the compressor off using the thermostat;
- turn the motor of the compressor on again using the thermostat after the minimum off-time prescribed in the user manual or allowed by the automatic control;
- repeat the off/on sequence 24 times and evaluate the results in accordance with Annex B. However, if the first test result is not within +/- 10 % of the limit, the equipment may be assessed for compliance on the basis of this single result and the test may be terminated;

b) by the analytical method:

- using as starting current, the locked rotor current and power factor of the motor of the compressor and of any other loads (such as a fan motor) which are turned on less than 2 s before or after the motor of the compressor starts; this procedure separates the voltage changes.

P_{st} and P_{lt} shall be analytically evaluated using the number of cycles per hour declared by the manufacturer.

A.15 Test conditions for arc welding equipment and allied processes

For arc-welding equipment, attended whilst in use, and allied processes, d_{\max} shall be evaluated against the 7 % limit in c) of clause 5, using the test method given in Annex B.

Additionally, equipment designed to be used for the Manual Metal Arc (MMA) process, P_{st} and d_c values shall be evaluated according to the procedures given in A.15.1 and A.15.2.

For all tests, the voltage drop caused by the equipment under normal operating conditions at rated maximum output power shall be within 3 % to 5 % of the supply voltage.

Although the scope of this standard is limited to equipment with input current equal to or less than 16 A, these test conditions shall also be valid for equipment with input current greater than 16 A.

The following test conditions shall be applicable to welding equipment designed according to IEC 60974-1. Test conditions for other types of equipment are under consideration.

A.15.1 Evaluation of P_{st}

Tests to evaluate P_{st} value for MMA welding equipment should be made using a test setup simulating welding with 3,25 mm basic electrodes. If the EUT is not suitable for these electrodes ($I_{2\max} < 130$ A), parameters representing a 2,5 mm electrode shall be used.

Table A.1 — Electrode parameters

Diameter mm	Basic data				
	I_{nom} A	U_{nom} V	Drops l/min	t_{drop} ms	$R_{\text{short-circuit}}$ mΩ
2,5	90	23,6	920	5,6	18
3,25	130	25,2	350	7,5	13

The value of the voltage change at the input terminals of the EUT, ΔU , which is crucial to the determination of P_{st} , shall be measured or calculated from input current measurements at the supply input terminals of the EUT using one of the following test procedures.

In all cases the arc-force dial, if existing, shall be set to the medium position, the connection to the dummy load should be made with two 3 m welding cables of 50 mm² Cu.

A.15.1.1 Test procedure A

The simple test procedure can give pessimistically high test results and may therefore also be used for preliminary testing.

The r.m.s input current is measured firstly with the EUT loaded with a resistive load equivalent to the nominal output current and voltage and secondly loaded with the specified short-circuit resistance, $R_{\text{short-circuit}}$ given in Table A.1. The difference of the measured r.m.s. input current values, ΔI_{input} , is used to derive ΔU values in the evaluation process.

A.15.1.2 Test procedure B

This test procedure is more complicated than Test A but it gives more realistic results.

The parameters given in Table A.1 shall be simulated by an electronically switched resistive load capable of changing from "nominal load" values to "short-circuit" values with the specified resistance for the specified droplet time at defined phase angles with respect to the input voltage.

The input current changes (10 ms r.m.s. samples) caused by these load-changes on the output shall be measured with dropstarts at zero-crossing and delays of 2 ms, 4 ms, 6 ms and 8 ms. The average arithmetical value of the resulting current changes shall be used in the evaluation process.

A.15.1.3 P_{st} evaluation process

The P_{st} of the EUT shall be calculated by use of the following equation:

$$P_{st} = 0,365 \times \Delta U \times F \times r^{0,31} \times R$$

where

$$\Delta U = \Delta I_{\text{input}} \times Z_{\text{ref}} \times 100 / U_n \%$$

F is an equivalence factor, depending on the shape of the voltage change characteristic; for MMA welding $F = 1,0$;

r is the frequency of the voltage changes per minute;

R is a coefficient depending on the repetition frequency, values of which are presented in Table A.1

Table A.2— Frequency factor R related to repetition rate « r »

r in voltage changes per minute	R	r in voltage changes per minute	R
0,2	0,98	2	0,99
0,3	1,03	3	1,00
0,4	1,02	4	1,00
0,5	1,00	5	1,03
0,6	1,00	6	1,02
0,7	1,02	7	1,02
0,8	1,00	8	1,03
0,9	1,00	9	1,03
1,0	1,00	10	1,08

NOTE In practice the MMA welding process is composed of workpiece preparation, welding time, time to work on the seam and time to change electrodes. Therefore, the estimated time of use during which voltage changes are produced is only 2,5 min in every 10 min period represented by a duty cycle of 0,25; the value of r for this typical operation is 0,2 changes/minute as only the voltage changes at the start and finish of a period of continuous welding are significant.

The result shall comply with the limit in clause 5. If the limit is exceeded, the equipment cannot be declared compliant with this part of IEC 61000 and the procedure according to IEC 61000-3-11 shall be applied.

A.15.2 Test procedure for d_c

The r.m.s. input current shall be measured firstly with the EUT loaded with a resistive load equivalent to the rated maximum output current and voltage and secondly with load equivalent to idling conditions. The difference between the r.m.s. input current values shall be used in the evaluation process.

A.15.2.1 Evaluation of d_c

d_c shall be determined by application of the following equation:

$$d_c = \Delta I_{\text{input}} \times Z_{\text{ref}} \times 100 / U_N$$

The result shall comply with the limit in clause 5. If the limit is exceeded, the equipment cannot be declared compliant with this part of IEC 61000 and the procedure according to IEC 61000-3-11 shall be applied.

Annex B (normative)

Test conditions and procedures for measuring d_{max} voltage changes caused by manual switching

B.1 Introduction

The considerable variations in the designs and characteristics of manually operated switches cause wide variations in the results of voltage change measurements. A test procedure dependent on the actual operation of the EUT's manually operated switch is essential.

Therefore a statistical method shall be applied to the measurement of d_{max} in order to achieve repeatability of test results.

B.2 Procedure

a) 24 measurements of inrush current data shall be carried out in the following order:

- start a measurement;
- switch on the EUT (to create a voltage change);
- let the EUT operate as long as possible under normal operating conditions during a measuring time interval of 1 min;
- switch off the EUT before the end of the 1 min measuring time interval and make sure that all moving parts inside the EUT come to standstill and that any d_{max} mitigation devices have had time to cool to the ambient temperature before the next measuring interval is started;
- start the next measurement.

NOTE The method of cooling may be natural or forced, and the cooling period should be specified by the equipment manufacturer if desired.

b) The final test result shall be calculated by deleting the highest and lowest results and take the arithmetical average of the remaining 22 values. \overline{A}

Annex ZA (normative)

Other international publications quoted in this standard with the references of the relevant European publications

This European Standard incorporates by dated or undated reference, provisions from other publications. These normative references are cited at the appropriate places in the text and the publications are listed hereafter. For dated references, subsequent amendments to or revisions of any of these publications apply to this European Standard only when incorporated in it by amendment or revision. For undated references the latest edition of the publication referred to applies.

NOTE When the international publication has been modified by CENELEC common modifications, indicated by (mod), the relevant EN/HD applies.

IEC publication	Date	Title	EN/HD	Date
60050(161)	1990	<i>International Electrotechnical Vocabulary (IEV) — Chapter 161: Electromagnetic compatibility</i>	—	—
A1				A1
60335-2-11	1993 ²⁾	<i>Safety of household and similar electrical appliances — Part 2-11: Particular requirements for tumbler dryers</i>	—	—
60725	1981	<i>Considerations on reference impedances for use in determining the disturbance characteristics of household appliances and similar electrical equipment</i>	—	—
60868 A1	1986 1990	<i>Flickermeter — Functional and design specifications</i>	EN 60868	1993 ³⁾
A1 IEC 60974-1	^{4), 5)}	<i>Arc welding equipment — Part 1: Welding power sources</i>	EN 60974-1	1998 A1
A1 IEC 61000-3-2 (mod)	^{4), 5)}	<i>Electromagnetic compatibility (EMC) — Part 3-2: Limits — Limits for harmonic current emissions (equipment input current up to and including 16 A per phase)</i>	EN 61000-3-2	2000 A1
61000-3-5	1994	<i>Electromagnetic compatibility (EMC) — Part 3: Limits — Section 5: Limitation of voltage changes, voltage fluctuations and flicker in public low-voltage supply systems, for equipment with rated current greater than 16 A per phase and not subject to conditional connection</i>	—	—
A1 IEC 61000-3-11 ^{4), 5)}		<i>Electromagnetic compatibility (EMC) — Part 3-11: Limits — Limitation of voltage changes, voltage fluctuations and flicker in public low-voltage supply systems — Equipment with rated current ≤ 75 A and subject to conditional connection</i>	EN 60974-1	1998 A1

²⁾ IEC 60335-2-11:1984, mod., is harmonized as EN 60335-2-11:1989.

³⁾ **A1** EN 60868 will be withdrawn and replaced by EN 61000-4-15. Flickermeters complying with EN 61000-4-15 may also be used for flicker measurements associated with this part of EN 61000-3.

⁴⁾ Undated reference.

⁵⁾ Valid edition at date of issue. **A1**

BS EN
61000-3-3:1995
IEC
61000-3-3:1994

BSI — British Standards Institution

BSI is the independent national body responsible for preparing British Standards. It presents the UK view on standards in Europe and at the international level. It is incorporated by Royal Charter.

Revisions

British Standards are updated by amendment or revision. Users of British Standards should make sure that they possess the latest amendments or editions.

It is the constant aim of BSI to improve the quality of our products and services. We would be grateful if anyone finding an inaccuracy or ambiguity while using this British Standard would inform the Secretary of the technical committee responsible, the identity of which can be found on the inside front cover. Tel: +44 (0)20 8996 9000. Fax: +44 (0)20 8996 7400.

BSI offers members an individual updating service called PLUS which ensures that subscribers automatically receive the latest editions of standards.

Buying standards

Orders for all BSI, international and foreign standards publications should be addressed to Customer Services. Tel: +44 (0)20 8996 9001. Fax: +44 (0)20 8996 7001. Email: orders@bsi-global.com. Standards are also available from the BSI website at <http://www.bsi-global.com>.

In response to orders for international standards, it is BSI policy to supply the BSI implementation of those that have been published as British Standards, unless otherwise requested.

Information on standards

BSI provides a wide range of information on national, European and international standards through its Library and its Technical Help to Exporters Service. Various BSI electronic information services are also available which give details on all its products and services. Contact the Information Centre. Tel: +44 (0)20 8996 7111. Fax: +44 (0)20 8996 7048. Email: info@bsi-global.com.

Subscribing members of BSI are kept up to date with standards developments and receive substantial discounts on the purchase price of standards. For details of these and other benefits contact Membership Administration. Tel: +44 (0)20 8996 7002. Fax: +44 (0)20 8996 7001. Email: membership@bsi-global.com.

Information regarding online access to British Standards via British Standards Online can be found at <http://www.bsi-global.com/bsonline>.

Further information about BSI is available on the BSI website at <http://www.bsi-global.com>.

Copyright

Copyright subsists in all BSI publications. BSI also holds the copyright, in the UK, of the publications of the international standardization bodies. Except as permitted under the Copyright, Designs and Patents Act 1988 no extract may be reproduced, stored in a retrieval system or transmitted in any form or by any means – electronic, photocopying, recording or otherwise – without prior written permission from BSI.

This does not preclude the free use, in the course of implementing the standard, of necessary details such as symbols, and size, type or grade designations. If these details are to be used for any other purpose than implementation then the prior written permission of BSI must be obtained.

Details and advice can be obtained from the Copyright & Licensing Manager. Tel: +44 (0)20 8996 7070. Fax: +44 (0)20 8996 7553. Email: copyright@bsi-global.com.

BSI
389 Chiswick High Road
London
W4 4AL