

INTERNATIONAL STANDARD

IEC 60335-2-9

Edition 5.1

2004-03

Edition 5:2002 consolidated with amendment 1:2004

Household and similar electrical appliances – Safety –

Part 2-9: Particular requirements for grills, toasters and similar portable cooking appliances



Reference number
IEC 60335-2-9:2002+A1:2004(E)

Publication numbering

As from 1 January 1997 all IEC publications are issued with a designation in the 60000 series. For example, IEC 34-1 is now referred to as IEC 60034-1.

Consolidated editions

The IEC is now publishing consolidated versions of its publications. For example, edition numbers 1.0, 1.1 and 1.2 refer, respectively, to the base publication, the base publication incorporating amendment 1 and the base publication incorporating amendments 1 and 2.

Further information on IEC publications

The technical content of IEC publications is kept under constant review by the IEC, thus ensuring that the content reflects current technology. Information relating to this publication, including its validity, is available in the IEC Catalogue of publications (see below) in addition to new editions, amendments and corrigenda. Information on the subjects under consideration and work in progress undertaken by the technical committee which has prepared this publication, as well as the list of publications issued, is also available from the following:

- **IEC Web Site** (www.iec.ch)

- **Catalogue of IEC publications**

The on-line catalogue on the IEC web site (www.iec.ch/searchpub) enables you to search by a variety of criteria including text searches, technical committees and date of publication. On-line information is also available on recently issued publications, withdrawn and replaced publications, as well as corrigenda.

- **IEC Just Published**

This summary of recently issued publications (www.iec.ch/online_news/justpub) is also available by email. Please contact the Customer Service Centre (see below) for further information.

- **Customer Service Centre**

If you have any questions regarding this publication or need further assistance, please contact the Customer Service Centre:

Email: custserv@iec.ch
Tel: +41 22 919 02 11
Fax: +41 22 919 03 00

INTERNATIONAL STANDARD

IEC 60335-2-9

Edition 5.1

2004-03

Edition 5:2002 consolidated with amendment 1:2004

Household and similar electrical appliances – Safety –

Part 2-9: Particular requirements for grills, toasters and similar portable cooking appliances

© IEC 2004 — Copyright - all rights reserved

No part of this publication may be reproduced or utilized in any form or by any means, electronic or mechanical, including photocopying and microfilm, without permission in writing from the publisher.

International Electrotechnical Commission, 3, rue de Varembé, PO Box 131, CH-1211 Geneva 20, Switzerland
Telephone: +41 22 919 02 11 Telefax: +41 22 919 03 00 E-mail: inmail@iec.ch Web: www.iec.ch



Commission Electrotechnique Internationale
International Electrotechnical Commission
Международная Электротехническая Комиссия

PRICE CODE

U

For price, see current catalogue

CONTENTS

FOREWORD	4
INTRODUCTION	6
1 Scope	7
2 Normative references	8
3 Definitions	8
4 General requirement	11
5 General conditions for the tests	12
6 Classification	12
7 Marking and instructions	12
8 Protection against access to live parts	13
9 Starting of motor-operated appliances	13
10 Power input and current	14
11 Heating	14
12 Void	15
13 Leakage current and electric strength at operating temperature	15
14 Transient overvoltages	16
15 Moisture resistance	16
16 Leakage current and electric strength	17
17 Overload protection of transformers and associated circuits	18
18 Endurance	18
19 Abnormal operation	18
20 Stability and mechanical hazards	20
21 Mechanical strength	20
22 Construction	21
23 Internal wiring	23
24 Components	23
25 Supply connection and external flexible cords	24
26 Terminals for external conductors	24
27 Provision for earthing	25
28 Screws and connections	25
29 Clearances, creepage distances and solid insulation	25
30 Resistance to heat and fire	25
31 Resistance to rusting	26
32 Radiation, toxicity and similar hazards	26
Annexes	30
Bibliography	30

Figure 101 – Examples of appliances	27
Figure 102 – Load for testing rotating spits	28
Figure 103 – Vessel for testing hotplates	29
Figure 104 – Vessel for testing induction hotplates	29
Table 101 – Quantity of liquid in the vessel	9

INTERNATIONAL ELECTROTECHNICAL COMMISSION

HOUSEHOLD AND SIMILAR ELECTRICAL APPLIANCES – SAFETY –

Part 2-9: Particular requirements for grills, toasters and similar portable cooking appliances

FOREWORD

- 1) The International Electrotechnical Commission (IEC) is a worldwide organization for standardization comprising all national electrotechnical committees (IEC National Committees). The object of IEC is to promote international co-operation on all questions concerning standardization in the electrical and electronic fields. To this end and in addition to other activities, IEC publishes International Standards, Technical Specifications, Technical Reports, Publicly Available Specifications (PAS) and Guides (hereafter referred to as “IEC Publication(s)”). Their preparation is entrusted to technical committees; any IEC National Committee interested in the subject dealt with may participate in this preparatory work. International, governmental and non-governmental organizations liaising with the IEC also participate in this preparation. IEC collaborates closely with the International Organization for Standardization (ISO) in accordance with conditions determined by agreement between the two organizations.
- 2) The formal decisions or agreements of IEC on technical matters express, as nearly as possible, an international consensus of opinion on the relevant subjects since each technical committee has representation from all interested IEC National Committees.
- 3) IEC Publications have the form of recommendations for international use and are accepted by IEC National Committees in that sense. While all reasonable efforts are made to ensure that the technical content of IEC Publications is accurate, IEC cannot be held responsible for the way in which they are used or for any misinterpretation by any end user.
- 4) In order to promote international uniformity, IEC National Committees undertake to apply IEC Publications transparently to the maximum extent possible in their national and regional publications. Any divergence between any IEC Publication and the corresponding national or regional publication shall be clearly indicated in the latter.
- 5) IEC provides no marking procedure to indicate its approval and cannot be rendered responsible for any equipment declared to be in conformity with an IEC Publication.
- 6) All users should ensure that they have the latest edition of this publication.
- 7) No liability shall attach to IEC or its directors, employees, servants or agents including individual experts and members of its technical committees and IEC National Committees for any personal injury, property damage or other damage of any nature whatsoever, whether direct or indirect, or for costs (including legal fees) and expenses arising out of the publication, use of, or reliance upon, this IEC Publication or any other IEC Publications.
- 8) Attention is drawn to the Normative references cited in this publication. Use of the referenced publications is indispensable for the correct application of this publication.
- 9) Attention is drawn to the possibility that some of the elements of this IEC Publication may be the subject of patent rights. IEC shall not be held responsible for identifying any or all such patent rights.

This part of International Standard IEC 60335 has been prepared by IEC technical committee 61: Safety of household and similar electrical appliances.

This consolidated version of IEC 60335-2-9 is based on the fifth edition (2002) [documents 61/2100/FDIS and 61/2131/RVD] and its amendment 1 (2004) [documents 61/2535/FDIS and 61/2579/RVD].

It bears the edition number 5.1.

A vertical line in the margin shows where the base publication has been modified by amendment 1.

This part 2 is to be used in conjunction with the latest edition of IEC 60335-1 and its amendments. It was established on the basis of the fourth edition (2001) of that standard.

NOTE 1 When “Part 1” is mentioned in this standard, it refers to IEC 60335-1.

This part 2 supplements or modifies the corresponding clauses in IEC 60335-1, so as to convert that publication into the IEC standard: Safety requirements for grills, toasters and similar portable cooking appliances.

When a particular subclause of Part 1 is not mentioned in this part 2, that subclause applies as far as is reasonable. When this standard states “addition”, “modification” or “replacement”, the relevant text in Part 1 is to be adapted accordingly.

NOTE 2 The following numbering system is used:

- subclauses, tables and figures that are numbered starting from 101 are additional to those in Part 1;
- unless notes are in a new subclause or involve notes in Part 1, they are numbered starting from 101, including those in a replaced clause or subclause;
- additional annexes are lettered AA, BB, etc.

NOTE 3 The following print types are used:

- requirements: in roman type;
- *test specification: in italic type;*
- notes: in small roman type.

Words in **bold** in the text are defined in Clause 3. When a definition concerns an adjective, the adjective and the associated noun are also in bold.

The committee has decided that the contents of the base publication and its amendment 1 will remain unchanged until 2005. At this date, the publication will be

- reconfirmed;
- withdrawn;
- replaced by a revised edition, or
- amended.

The following differences exist in the countries indicated below.

- 3.1.9: Different loads and test methods are used (Canada and USA).
- 5.101: If the appliance incorporates a motor, the motor is tested at rated voltage (USA).
- 7.12: Identification of the connector is to be marked on the appliance (Canada and USA).
- 11.2: 9,5 mm thick plywood is used for the test corner (USA).
- 11.7: The test duration is based on the quantity of food (USA).
- 11.8: The modification does not apply (Norway).
- 11.8: A temperature rise of 100 K is allowed for the wall of the test corner (USA).
- 15.2: A different solution is used and the test is not carried out on ovens, hotplates or cookers (USA).
- 15.101: Appliances are immersed to the marked level only (USA).
- 19.2: A 300 mm deep simulated cabinet is located 400 mm above the countertop (Canada and USA).
- 19.2: The test is different. Additional tests are carried out on hotplates and cookers (USA):
- 19.101: A combustible cloth is placed above the toaster and the residual bread is left in place (Canada and USA).
- 19.102: Disks having different sizes are used (USA).
- 20.101: The test is not carried out (USA).
- 21.101: The test is different (USA).
- 22.106: The requirement is not applicable (USA).
- 22.107: Different test methods and numbers of cycles are used (Canada and USA).
- 22.110: The test is not carried out (USA).
- 22.111: The test is not carried out (USA).
- 22.112: The test is not carried out (USA).
- 24.1.3: The test is not carried out (USA).
- 24.101: The test is not carried out (USA).
- 25.7: The free length of the supply cord is specified; in some cases, it is 1,8 m to 2,1 m for appliances intended to be connected to fixed socket-outlets, while in others it is 0,6 m to 2,1 m for appliances normally used on a table or similar surface (Canada and USA).

INTRODUCTION

It has been assumed in the drafting of this International Standard that the execution of its provisions is entrusted to appropriately qualified and experienced persons.

This standard recognizes the internationally accepted level of protection against hazards such as electrical, mechanical, thermal, fire and radiation of appliances when operated as in normal use taking into account the manufacturer's instructions. It also covers abnormal situations that can be expected in practice and takes into account the way in which electromagnetic phenomena can affect the safe operation of appliances.

This standard takes into account the requirements of IEC 60364 as far as possible so that there is compatibility with the wiring rules when the appliance is connected to the supply mains. However, national wiring rules may differ.

If an appliance within the scope of this standard also incorporates functions that are covered by another part 2 of IEC 60335, the relevant part 2 is applied to each function separately, as far as is reasonable. If applicable, the influence of one function on the other is taken into account.

This standard is a product family standard dealing with the safety of appliances and takes precedence over horizontal and generic standards covering the same subject.

An appliance that complies with the text of this standard will not necessarily be considered to comply with the safety principles of the standard if, when examined and tested, it is found to have other features which impair the level of safety covered by these requirements.

An appliance employing materials or having forms of construction differing from those detailed in the requirements of this standard may be examined and tested according to the intent of the requirements and, if found to be substantially equivalent, may be considered to comply with the standard.

.....

HOUSEHOLD AND SIMILAR ELECTRICAL APPLIANCES – SAFETY –

Part 2-9: Particular requirements for grills, toasters and similar portable cooking appliances

1 Scope

This clause of Part 1 is replaced by the following.

This International Standard deals with the safety of electric **portable appliances** for household purposes that have a cooking function such as baking, roasting and grilling, their **rated voltage** being not more than 250 V.

NOTE 101 Examples of appliances that are within the scope of this standard are

- **barbecues** for indoor use;
- **breadmakers**;
- **contact grills** (griddles);
- **cookers**;
- **food dehydrators**;
- **hotplates**;
- **portable ovens**;
- **raclette grills**;
- **radiant grills**;
- **roasters**;
- **rotary grills**;
- rotisseries;
- **toasters**;
- **waffle irons**;

Examples are illustrated in Figure 101.

As far as is practicable, this standard deals with the common hazards presented by appliances that are encountered by all persons in and around the home. However, in general, it does not take into account

- the use of appliances by young children or infirm persons without supervision;
- playing with the appliance by young children.

NOTE 102 Attention is drawn to the fact that

- for appliances intended to be used in vehicles or on board ships or aircraft, additional requirements may be necessary;
- in many countries additional requirements are specified by the national health authorities, the national authorities responsible for the protection of labour and similar authorities.

NOTE 103 This standard does not apply to

- **stationary ovens** and **stationary grills** (IEC 60335-2-6);
- warming plates (IEC 60335-2-12);
- frying pans and deep fat fryers (IEC 60335-2-13);
- microwave ovens (IEC 60335-2-25);
- barbecues for outdoor use (IEC 60335-2-78);
- appliances intended for commercial catering;
- appliances intended to be used in locations where special conditions prevail, such as the presence of a corrosive or explosive atmosphere (dust, vapour or gas).

2 Normative references

This clause of part 1 is applicable except as follows.

Addition:

IEC 60068-2-52, *Environmental testing – Part 2: Tests – Test Kb: Salt mist, cyclic (sodium chloride solution)*

3 Definitions

This clause of Part 1 is applicable except as follows.

3.1.9 Replacement:

normal operation

operation of the appliance as specified in the following subclauses

NOTE 101 Appliances not mentioned but which nevertheless perform one of the functions are operated as specified for this function as far as possible.

3.1.9.101 Toasters are loaded with the maximum number of slices of white bread specified in the instructions and operated in cycles, each cycle consisting of an operating period and a rest period. The bread is approximately 24 h old and the dimensions of the slices are approximately 100 mm × 100 mm × 10 mm. The rest periods have a duration of 30 s or the minimum period needed for the resetting of a control, whichever is longer. The slices of bread are replaced during each rest period. The operating period is established by adjusting controls to give the bread a golden-brown colour. For toasters without a control, each operating period is terminated as soon as the colour of the bread turns golden-brown.

Toasters incorporating a device for heating rolls are loaded with the maximum number of rolls specified in the instructions. The **toaster** is operated in cycles, each cycle consisting of an operating period followed by a rest period of 30 s when the rolls are turned or replaced. The control is adjusted in accordance with the instructions. If instructions are not given, the control is adjusted for the toasting operation.

Sandwich-toasting attachments are loaded with one or more sandwiches that are positioned in accordance with the instructions to produce the most unfavourable result. Each sandwich comprises two slices of white bread filled with a single slice of suitable cheese having an area equal to a slice of bread and a thickness of approximately 5 mm. The toaster is then operated in accordance with the instructions in cycles, each cycle consisting of a toasting operation followed by a rest period of 30 s, or the minimum period needed for the resetting of a control, whichever is longer.

NOTE Processed cheese and other cheeses that readily melt when heated are suitable.

3.1.9.102 Rotary grills are operated with the load on the rotating spit shown in Figure 102.

3.1.9.103 Waffle irons having a **thermostat** are operated with the **thermostat** adjusted to the highest setting. Other **waffle irons** are operated so that the temperature at the centre of the heated surface is maintained at 210 °C ± 15 °C by switching the supply on and off.

3.1.9.104 Ovens are operated with the door closed. **Ovens** having a **thermostat** are operated so that the mean temperature in the centre of the cavity is maintained at 240 °C ± 4 °C or at the value obtained with the **thermostat** adjusted to its highest setting, if this results in a lower temperature. Other **ovens** are operated so that the temperature in the centre of the cavity is maintained at 240 °C ± 15 °C by switching the supply on and off.

3.1.9.105 Roasters are operated with the lid closed. The mean temperature in the centre of the container is maintained at $240\text{ °C} \pm 4\text{ °C}$, if necessary by switching the supply on and off.

3.1.9.106 Radiant grills, rotary grills and raclette appliances are operated with the controls adjusted in accordance with the instructions, or if instructions are not provided with the controls adjusted to the highest setting. Doors or lids are open unless otherwise specified in the instructions.

Contact grills having a **thermostat** are operated with the **thermostat** adjusted to the highest setting. Other **contact grills** are operated so that the temperature at the centre of the heated surface is maintained at $275\text{ °C} \pm 15\text{ °C}$ by switching the supply on and off.

Raclette grills are operated with doors or lids open, unless otherwise specified in the instructions. Controls are adjusted in accordance with the instructions, pans being in position or removed, whichever is more unfavourable.

3.1.9.107 Barbecues are operated with food supports in the lowest position. Controls are adjusted to the highest setting, any covers or shields being positioned in accordance with the instructions.

NOTE **Barbecues** are operated without water even if the use of water is recommended.

3.1.9.108 Hotplates, other than **induction hotplates**, are operated with vessels containing water. The vessels are made of unpolished commercial quality aluminium, have a flat bottom and are covered with a lid. A suitable vessel is specified in Figure 103. Controls are adjusted to their highest setting until the water boils and then adjusted so that the water simmers. Water is added to maintain the level during boiling.

NOTE 1 The lid is positioned so that steam does not affect the test.

Induction hotplates are operated with vessels, as specified in Figure 104, containing cooking oil. Controls are adjusted to their highest setting until the oil temperature reaches $180\text{ °C} \pm 4\text{ °C}$ and are then adjusted so that this temperature is maintained. The oil temperature is measured 1 cm above the centre of the bottom of the vessel.

For all **hotplates**, the diameter of the bottom of the vessel is approximately equal to the diameter of the **cooking zone** and the quantity of liquid is specified in Table 101. The vessel is positioned centrally on the **cooking zone**.

Table 101 – Quantity of liquid in the vessel

Diameter of cooking zone mm	Quantity of water or oil l
≤110	0,6
>110 and ≤145	1,0
>145 and ≤180	1,5
>180 and ≤220	2,0
>220 and ≤300	3,0

NOTE 2 If several **cooking zones** are marked for one **hotplate**, the most unfavourable zone is used for the test.

NOTE 3 For non-circular **cooking zones**, the smallest non-circular vessel is used that will cover the **cooking zone** as far as possible, taking into account the **hob** rim and other vessels. The quantity of liquid is determined on the basis of the minor diameter of the **cooking zone**.

3.1.9.109 Raclette appliances are operated with the controls adjusted in accordance with the instructions, or if instructions are not provided, with the controls adjusted to the highest setting.

3.1.9.110 Food dehydrators are operated empty.

3.1.9.111 Breadmakers are operated using the most unfavourable cycle and ingredients specified in the instructions.

NOTE The most unfavourable cycle may be for a function such as jam-making that allows the heating element and the kneading motor to operate simultaneously.

**3.101
toaster**

appliance intended for toasting slices of bread by radiant heat

**3.102
waffle iron**

appliance having two heated hinged plates that are shaped to contain batter

**3.103
oven**

appliance having a heated cavity with a door and constructed so that food that may be in a container can be placed on a shelf

**3.104
roaster**

appliance having a heated container with a lid and constructed so that food can be placed in it

**3.105
rotary grill**

appliance having a **visible glowing heating element** and a rotating spit to support the food

NOTE A **rotary grill** is also known as a rotisserie.

**3.106
radiant grill**

appliance having a **visible glowing heating element** and a support on which food can be placed

NOTE A **radiant grill** may be placed in a compartment with or without a door.

**3.107
contact grill**

appliance having a heated surface on which food is placed. It may have a second heated surface to cover the food

NOTE A **contact grill** with only one heated surface is known as a griddle.

**3.108
sandwich-toasting attachment**

accessory for use with a **toaster** for toasting sandwiches

**3.109
raclette grill**

appliance for melting slices of cheese placed in small pans positioned under the heating element

NOTE **Raclette grills** may have a surface that is used as a griddle.

3.110**raclette appliance**

radiant grill for melting the surface of a large piece of cheese

3.111**barbecue**

radiant grill having a heating element located under the food support

3.112**hotplate**

appliance having one or more **heating units** on which vessels can be placed for cooking purposes

NOTE **Hotplates** do not incorporate an **oven** or grill.

3.113**induction hotplate**

hotplate that can heat at least one metallic vessel by means of eddy currents

NOTE The eddy currents are induced in the bottom of the vessel by the electromagnetic field of a coil.

3.114**cooker**

appliance incorporating a **hotplate** and an **oven**

NOTE **Cookers** may incorporate a grill.

3.115**food dehydrator**

appliance for dehydrating food by means of heated air

NOTE The appliance may incorporate a fan.

3.116**heating unit**

part of the appliance that fulfils an independent cooking or warming function

3.117**cooking zone**

area marked on a **hotplate** where the vessel is placed for heating food

3.118**touch control**

control actuated by contact or proximity of a finger, with little or no movement of the contact surface

3.119**breadmaker**

appliance intended for making bread comprising a heated compartment incorporating dough kneading facilities

4 General requirement

This clause of Part 1 is applicable.

5 General conditions for the tests

This clause of Part 1 is applicable except as follows.

5.2 Addition:

NOTE 101 If the test of 15.101 has to be carried out, three additional samples are required.

5.3 Addition:

If it is evident from the construction of the appliance that the test of one function will produce more favourable results than another, this function is not tested.

5.6 Addition:

If two or more cooking functions can be performed simultaneously, they are tested at the same time.

5.101 Induction hotplates are operated as specified for **motor-operated appliances**. Other appliances are tested as specified for **heating appliances**, even if they incorporate motors.

6 Classification

This clause of Part 1 is applicable except as follows.

6.2 Addition:

Appliances intended for outdoor use shall be at least IPX4.

7 Marking and instructions

This clause of Part 1 is applicable except as follows.

7.1 Addition:

The **rated power input** or **rated current** of **induction hotplates** shall also be marked.

Appliances intended to be partially immersed in water for cleaning shall be marked with the maximum level of immersion and the substance of the following:

Do not immerse beyond this level.

7.12 Addition:

The instructions for appliances incorporating an appliance inlet, and intended to be partially or fully immersed in water for cleaning, shall state that the connector must be removed before the appliance is cleaned and that the appliance inlet must be dried before the appliance is used again.

The instructions for appliances intended to be used with a connector incorporating a **thermostat** shall state that only the appropriate connector must be used.

The instructions for appliances intended for outdoor use shall include the substance of the following:

- the appliance is suitable for outdoor use;
- the supply cord should be regularly examined for signs of damage, and if the cord is damaged, the appliance must not be used;
- the appliance must be supplied through a residual current device (RCD) having a rated residual operating current not exceeding 30 mA;
- the appliance is to be connected to a socket-outlet having an earthing contact (for **class I appliances**).

The instructions for **ovens** shall include the substance of the following:

The door or the outer surface may get hot when the appliance is operating.

The instructions for **toasters** shall include the substance of the following:

The bread may burn, therefore do not use the **toaster** near or below combustible material, such as curtains.

The instructions for **barbecues** shall include the substance of the following:

WARNING: Charcoal or similar combustible fuels must not be used with this appliance.

The instructions for **barbecues** intended to be used with water shall state the maximum quantity of water to be poured into the appliance.

The instructions for **hotplates** having surfaces of glass-ceramic or similar material protecting **live parts** shall include the substance of the following:

WARNING: If the surface is cracked, switch off the appliance to avoid the possibility of electric shock.

The instructions for **induction hotplates** shall include the substance of the following:

Metallic objects such as knives, forks, spoons and lids should not be placed on the hotplate since they can get hot.

The instructions for **breadmakers** shall state the maximum quantities of flour and raising agent that may be used.

8 Protection against access to live parts

This clause of Part 1 is applicable except as follows.

8.1.1 Addition:

*For **toasters** having a crumb tray, the test finger is not applied through the crumb-tray opening to **live parts** that are disconnected by the operation of a double pole switch. However, it shall not be possible to touch these parts with test probe 41 of IEC 61032.*

9 Starting of motor-operated appliances

This clause of Part 1 is not applicable.

10 Power input and current

This clause of Part 1 is applicable except as follows.

10.1 Addition:

*The power input of **induction hotplates** is measured separately.*

10.2 Addition:

*The current of **induction hotplates** is measured separately.*

11 Heating

This clause of Part 1 is applicable except as follows.

11.2 Addition:

***Radiant grills** and **raclette grills** that are loaded from the front, **rotary grills**, **ovens**, **breadmakers**, **cookers** and **hotplates** are placed with their backs as near as possible to one of the walls of the test corner and away from the other wall. Other appliances are placed away from the walls.*

11.3 Addition:

NOTE 101 If the magnetic field of an **induction hotplate** unduly influences the results, the temperature rises can be determined using platinum resistances with twisted connecting wires or any equivalent means.

11.4 Addition:

*If the temperature rise limits are exceeded in appliances incorporating motors, transformers or **electronic circuits**, and the power input is lower than the **rated power input**, the test is repeated with the appliance supplied at 1,06 times **rated voltage**.*

11.7 Replacement:

***Breadmakers** are operated for one cycle.*

***Toasters** are operated for 15 min. Unless they are constructed to toast only one slice of bread, they are tested for a further 5 min with one slice of bread inserted in the most unfavourable position.*

***Toasters** incorporating a device for heating rolls are operated for five cycles.*

***Toasters** having **sandwich-toasting attachments** are also tested for five cycles of operation. They are also tested for one cycle of operation with the sandwich in the most unfavourable position.*

***Radiant grills** are operated for a period of 30 min, for the maximum period indicated in the instructions or for the maximum period allowed by a timer, whichever is the longer.*

***Ovens**, **roasters** and **rotary grills** are operated until steady conditions are established but for not longer than 60 min. However, if a **rotary grill** has a timer, the timer is reset as many times as necessary to establish steady conditions.*

Contact grills having thermostats are operated until steady conditions are established. Other **contact grills** are operated for 30 min after the centre of the heating surface attains a temperature of 275 °C.

Waffle irons are operated until steady conditions are established but for not longer than 30 min after the centre of the heating surface attains a temperature of 210 °C.

Raclette grills, barbecues and food dehydrators are operated until steady conditions are established.

Induction hotplates are operated for 30 min. Other **hotplates** are operated for 60 min.

For **cookers**, combinations of **heating units** that can be energised simultaneously are tested together, the **heating units** being switched on for the duration specified.

NOTE 101 If the appliance is subjected to more than one test, it is cooled to room temperature before each test.

11.8 Modification:

For **radiant grills, rotary grills, raclette grills, hotplates and cookers**, instead of 65 K, the temperature rise of the wall of the test corner shall not exceed 75 K.

Addition:

When an appliance connector incorporates a **thermostat**, the temperature rise limit for the pins of the appliance inlet does not apply.

The temperature rise limits of motors, transformers and components of **electronic circuits**, including parts directly influenced by them, may be exceeded when the appliance is operated at 1,15 times **rated power input**.

Cheese used in **sandwich toasting attachments** shall not flow into places where it could give rise to a hazard, such as reducing **clearances** or **creepage distances** below the values specified in Clause 29.

12 Void

13 Leakage current and electric strength at operating temperature

This clause of Part 1 is applicable except as follows.

13.1 Addition:

If a grill is incorporated in an **oven**, either the **oven** or the grill is operated, whichever is more unfavourable.

13.2 Addition:

If there is earthed metal between **live parts** and the surface of glass-ceramic or similar material of **hotplates**, the leakage current is measured between **live parts** and each vessel in turn connected to the earthed metal. It shall not exceed 0,75 mA. If there is no earthed metal, the leakage current, measured between **live parts** and each of the vessels in turn, shall not exceed 0,25 mA.

13.3 Addition:

If there is earthed metal between **live parts** and the surface of glass-ceramic or similar material of **hotplates**, a test voltage of 1 000 V is applied between **live parts** and all the vessels connected to the earthed metal. If there is no earthed metal, a test voltage of 3 000 V is applied between **live parts** and the vessels.

14 Transient overvoltages

This clause of Part 1 is applicable.

15 Moisture resistance

This clause of Part 1 is applicable except as follows.

15.2 Addition:

For **ovens**, 0,5 l of water containing approximately 1 % NaCl is poured uniformly over the bottom surface of the **oven**.

Hotplates and **cookers** are positioned so that the top surface is horizontal. A vessel having the largest diameter shown in Figure 103, which does not exceed the diameter of the **cooking zone**, is completely filled with water containing approximately 1 % NaCl and positioned centrally over the **cooking zone**. A further quantity of approximately 0,5 l of the solution is poured steadily into the vessel over a period of 15 s. The test is carried out on each **cooking zone** in turn, after removing any residual solution from the appliance.

If the heating element of a **hotplate** incorporates a thermal control, 0,02 l of the saline solution is poured over the **cooking zone** so that it flows over the control. A vessel is then placed on the **cooking zone** to depress any movable part.

For **hotplates** having ventilating openings in the heated surface, 0,2 l of the saline solution is poured steadily through the funnel onto the ventilating openings. The funnel has an outlet diameter of 8 mm and is positioned vertically with the outlet 200 mm above the heated surface. The funnel is positioned above the ventilating openings so that the solution enters the appliance in the most unfavourable way.

NOTE 101 If the opening is protected, the funnel is positioned so that the solution falls onto the heated surface as close as possible to the opening.

For other appliances with heating elements that are covered by vessels in normal use, the spillage test is carried out by steadily pouring saline solution onto the heating surface over a period of 1 min, 0,1 l of solution being used for every 100 cm² of the heating surface.

The spillage test is not carried out on **roasters**.

15.101 Appliances intended to be partially or completely immersed in water for cleaning shall have adequate protection against the effects of immersion.

Compliance is checked by the following tests, which are carried out on three additional appliances.

The appliances are operated under **normal operation** at 1,15 times **rated power input**, until the **thermostat** operates for the first time. Appliances without a **thermostat** are operated until steady conditions are established. The appliances are disconnected from the supply, any appliance connector being withdrawn. They are then completely immersed in water containing approximately 1 % NaCl and having a temperature between 10 °C and 25 °C, unless they are marked with the maximum level of immersion, in which case they are immersed 5 cm deeper than this level.

After 1 h, the appliances are removed from the saline solution, dried and subjected to the leakage current test of 16.2.

NOTE Care is to be taken to ensure that all moisture is removed from the insulation around the pins of appliance inlets.

This test is carried out four more times, after which the appliances shall withstand the electric strength test of 16.3, the voltage being as specified in Table 4.

The appliance having the highest leakage current after the fifth immersion is dismantled and inspection shall show that there is no trace of liquid on insulation that could result in a reduction of **clearances** and **creepage distances** below the values specified in Clause 29.

The remaining two appliances are operated under **normal operation** for 240 h at 1,15 times **rated power input**. After this period, the appliances are disconnected from the supply and immersed again for 1 h. They are then dried and subjected to the electric strength test of 16.3, the voltage being as specified in Table 4.

Inspection shall show that there is no trace of liquid on insulation that could result in a reduction of **clearances** and **creepage distances** below the values specified in Clause 29.

16 Leakage current and electric strength

This clause of Part 1 is applicable except as follows.

16.1 Addition:

For **hotplates**, the tests are carried out with a vessel as specified for **normal operation** placed on each **cooking zone**.

16.2 Addition:

If there is earthed metal between **live parts** and the surface of glass-ceramic or similar material of **hotplates**, the leakage current is measured between **live parts** and each vessel in turn connected to the earthed metal. It shall not exceed 0,75 mA. If there is no earthed metal, the leakage current, measured between **live parts** and each of the vessels in turn, shall not exceed 0,25 mA.

16.3 Addition:

If there is earthed metal between **live parts** and the surface of glass-ceramic or similar material of **hotplates**, a test voltage of 1 250 V is applied between **live parts** and all the vessels connected to the earthed metal. If there is no earthed metal, a test voltage of 3 000 V is applied between **live parts** and the vessels.

17 Overload protection of transformers and associated circuits

This clause of Part 1 is applicable.

18 Endurance

This clause of Part 1 is not applicable.

19 Abnormal operation

This clause of Part 1 is applicable except as follows.

19.1 Addition:

The tests of 19.4 and 19.5 are only applicable to

- **breadmakers;**
- **contact grills;**
- **food dehydrators;**
- *the following appliances, if they incorporate a timer or if their instructions indicate a cooking operation longer than 1 h:*
 - **ovens;**
 - **roasters;**
 - **hotplates;**
 - **cookers;**
 - **rotary grills.**

Toasters are also subjected to the tests of 19.101 and 19.102.

Induction hotplates are also subjected to the tests of 19.103 and 19.104.

19.2 Addition:

***Radiant grills** and **raclette grills** that are loaded from the front, **rotary grills**, **ovens**, **hotplates** and **cookers** are placed as near to the walls of the test corner as possible.*

*Appliances are tested empty. Lids and doors are open or closed, whichever is more unfavourable. **Detachable parts** are in position or removed, whichever is more unfavourable.*

***Hotplates** are operated without a vessel and with the controls adjusted to the highest setting.*

***Induction hotplates** are operated under the conditions of Clause 11 but with empty vessels, controls being adjusted to the highest setting.*

***Cookers** are only tested with the **heating unit** that results in the most unfavourable conditions, their controls being adjusted to the highest setting. However **ovens** are operated if they do not have an indicating lamp to show when they are switched on, controls being adjusted to the highest setting.*

NOTE 101 A lamp used for illuminating the **oven**, which is visible through the door and is automatically switched on and off with the **oven**, is considered to be an indicating lamp.

19.4 Addition:

*Air-circulating fans of **food dehydrators** are disconnected.*

19.8 Not applicable.

19.10 Not applicable.

19.13 Addition:

During the test of 19.102 any flames or smoke from the bread are ignored.

*The temperature rise of the windings of **induction hotplates** shall not exceed the values specified in 19.7.*

*The electric strength test of **induction hotplates** is carried out immediately after switching off the appliance.*

19.101 Toasters are operated at **rated power input** and under **normal operation**, but without bread, for six cycles of operation. The appliance is then allowed to cool to approximately room temperature.

This test is carried out 500 times.

The mechanism shall operate satisfactorily and no sustained arcing shall occur. Electrical connections shall not work loose and the appliance shall withstand the electric strength test of 16.3.

NOTE 1 Forced cooling may be used.

NOTE 2 A simulated load may be necessary to operate the mechanism.

NOTE 3 Subclause 19.13 does not apply.

19.102 Toasters, loaded with the bread specified for **normal operation**, are operated at **rated power input**. The ejector mechanism is prevented from releasing and the supply is maintained to the heating elements after the timer has completed its cycle. The test is terminated after any fire has extinguished, after which any residual bread is removed from the **toaster**.

19.103 Induction hotplates are supplied at **rated voltage** and operated with a steel disk placed on the centre of the **cooking zone**. The disk has a thickness of 6 mm and the smallest diameter, rounded up to the nearest centimetre, which allows the appliance to operate.

19.104 Induction hotplates are supplied at **rated voltage** and operated under **normal operation** but with any control that limits the temperature during the test of Clause 11 short-circuited.

NOTE If the appliance incorporates more than one control, they are short circuited in turn.

The temperature rise of the oil shall not exceed 270 K.

20 Stability and mechanical hazards

This clause of Part 1 is applicable except as follows.

20.101 Ovens having doors with a horizontal hinge at their lower edge and on which a load is likely to be placed shall have adequate stability.

Compliance is checked by the following test.

The oven is placed on a horizontal surface with the door open and a mass of 3,5 kg is gently placed on the geometric centre of the door.

NOTE A sandbag may be used for the load.

The oven shall not tilt.

This test is not carried out on ovens with doors having a dimension less than 225 mm from the hinge to the opposite edge or on ovens with doors which cannot support dishes in the fully open position.

21 Mechanical strength

This clause of Part 1 is applicable except as follows.

21.1 Addition:

For appliances intended for outdoor use, the impact energy is increased to 0,7 J.

*If the appliance incorporates **visibly glowing heating elements** enclosed in glass tubes, the blows are applied to the tubes as mounted in the appliance if they are*

- located at the top of the oven and accessible to test probe 41 of IEC 61032;*
- located elsewhere in the oven and accessible to test probe B of IEC 61032.*

*For **hotplates** having surfaces of glass-ceramic or similar material, three blows are applied to parts of the surface that are not exposed to impacts during the test of 21.101, the impact energy being $0,70 \text{ J} \pm 0,05 \text{ J}$. The blows are not applied to surfaces within 20 mm of knobs.*

NOTE 101 If the surface comprises a single piece of material, except for the outer frame, this test is not carried out.

21.101 Surfaces of **hotplates** of glass-ceramic or similar material shall withstand the stresses liable to occur in normal use.

Compliance is checked by the following test.

*The hotplate is operated at **rated power input** with its control adjusted to the highest setting. **Induction hotplates** are operated as specified in Clause 11. When steady conditions are established, the hotplate is switched off and a vessel with its base horizontal is dropped from a height of 150 mm onto the **cooking zone**. The vessel has a copper or aluminium base that is flat over a diameter of $120 \text{ mm} \pm 10 \text{ mm}$, its edges being rounded with a radius of at least 10 mm. It is uniformly filled with at least 1,3 kg of sand or shot so that the total mass is $1,80 \text{ kg} \pm 0,01 \text{ kg}$.*

*The vessel is dropped 10 times onto each **cooking zone**. It is removed and the appliance is operated at **rated power input** until steady conditions are established.*

A quantity of $1_0^{+0,1}$ l of water containing approximately 1 % NaCl is poured steadily over the **hotplate**.

The appliance is then disconnected from the supply. After 15 min all excess liquid is removed and the appliance is allowed to cool to approximately room temperature. The same quantity of the saline solution is poured over the **hotplate** after which excess liquid is removed again.

The surface of the **hotplate** shall not be broken and the appliance shall withstand the electric strength test of 16.3.

22 Construction

This clause of Part 1 is applicable except as follows.

22.24 Addition:

Heating elements shall be constructed or supported so they are unlikely to become displaced in normal use.

Compliance is checked by inspection.

22.101 Radiant grills shall not incorporate a timer that is intended to delay the operation of a heating element, unless they have a **thermostat** and are incorporated in an **oven** or other compartment.

Compliance is checked by inspection.

22.102 Barbecues shall not have bare heating elements.

Bare heating elements for **ovens** shall only be located at the top of the heated compartment.

Compliance is checked by inspection.

22.103 Oven vents shall be constructed so that they do not discharge moisture or grease in such a way that **clearances** and **creepage distances** are affected.

Compliance is checked by inspection.

22.104 Ovens shall be constructed so that shelves can easily slide in the supports and do not fall out of position when the sides are displaced as much as possible.

Compliance is checked by inspection and by manual test.

22.105 Appliances shall not have openings on the underside that would allow small items to penetrate and touch **live parts**.

*Compliance is checked by inspection and by measuring the distance between the supporting surface and **live parts** through openings. This distance shall be at least 6 mm. However, if the appliance is fitted with legs, this distance is increased to 10 mm if the appliance is intended to stand on a table and to 20 mm if it is intended to stand on the floor.*

22.106 Grills and **barbecues** shall be constructed so that their heating elements are fixed in position or prevented from operating when they are not in their normal position of use.

Compliance is checked by inspection.

22.107 Hotplates shall be constructed so that heating elements are prevented from rotating about a vertical axis and are adequately supported in all positions of adjustment of their supports.

NOTE If a heating element is clamped by a nut on a central stud, an additional means is required to prevent its rotation.

Compliance is checked by inspection.

22.108 Hotplates shall be constructed so that inadvertent operation of **touch controls** is unlikely if this could give rise to a hazardous situation due to

- spillage of liquids, including that caused by a vessel boiling over;
- a damp cloth placed on the control panel.

*Compliance is checked by the following test, the appliance being supplied at **rated voltage**.*

Sufficient water to completely cover the control panel to a depth not exceeding 2 mm, with a minimum of 140 ml, is poured steadily over the control panel so that bridging occurs between combinations of touch pads.

The test is carried out with each heating element energised in turn and then without energising any heating element.

A cloth having a mass between 140 g/m² and 170 g/m² and dimensions of 400 mm × 400 mm is folded four times into a square pad and saturated with water. It is placed over the control panel in any position.

There shall be no inadvertent operation of any heating element for longer than 10 s.

22.109 Hotplates incorporating **touch controls** shall require at least two manual operations to switch on a heating element but only one to switch it off.

NOTE Touching the contact surface at the same point twice is not considered to be two operations.

Compliance is checked by manual test.

22.110 Induction hotplates shall be constructed so that they can only be operated with a suitable vessel placed on the **cooking zone**.

*Compliance is checked by the following test, the appliance being supplied at **rated voltage**.*

*An iron bar 2 mm thick having dimensions 100 mm × 20 mm is placed in the most unfavourable position on the **cooking zone**. The controls are adjusted to their maximum setting.*

The temperature rise of the bar shall not exceed 35 K.

22.111 Heating elements in **breadmakers** shall be located so that they are not exposed to dough that may rise over the edge of the dough container during normal use of the appliance.

Compliance is checked by inspection.

22.112 Reconnection of the power supply to a **breadmaker** after an interruption shall not result in a fire due to an extended heating period.

Compliance is checked by the following test.

*All batteries are removed and the **breadmaker** is supplied at **rated voltage** and operated in its heating mode without a load.*

After 1 min, the power supply is interrupted for a period of 5 min and then restored. The appliance shall continue to operate in its heating mode from the same point in the cycle, or a manual operation shall be required to restart it.

If the appliance continues to operate automatically, the test is repeated but with a 5 min longer period of interruption. If the appliance still continues to operate automatically, the test is repeated but with the periods of interruption increased by at least 5 min each time.

The appliance shall eventually require a manual operation to restart it.

23 Internal wiring

This clause of Part 1 is applicable except as follows.

23.3 Addition:

For appliances which can be opened to two positions, 1 000 flexings are made with the part moved to the fully open position and the remaining flexings to the other position.

24 Components

This clause of Part 1 is applicable except as follows.

24.1.3 Addition:

*Switches controlling heating elements of **hotplates** are subjected to 50 000 cycles of operation.*

24.1.4 Modification

The following numbers of cycles of operation apply:

- *energy regulators*
 - *for automatic action* 100 000
 - *for manual action* 10 000
- ***self-resetting thermal cut-outs** for heating elements of glass-ceramic **hotplates*** 100 000

24.1.5 Addition:

For appliance couplers incorporating **thermostats**, **thermal cut-outs** or **fuses** in the connectors, IEC 60320-1 is applicable except that

- the earthing contact of the connector is allowed to be accessible, provided that this contact is not likely to be gripped during insertion or withdrawal of the connector;
- the temperature required for the test of Clause 18 is that measured on the pins of the appliance inlet during the test of Clause 11 of this standard;
- the breaking-capacity test of Clause 19 is carried out using the inlet of the appliance;
- the temperature rise of current-carrying parts specified in Clause 21 is not determined.

NOTE 101 Thermal controls are not allowed in connectors complying with the standard sheets of IEC 60320-1.

24.101 Thermostats and energy regulators incorporating an **off position** shall not switch on as a result of variations in ambient temperature.

Compliance is checked by the following test that is carried out on three devices.

The device, set at the **off position**, is placed for 2 h in an ambient temperature of $-20 \frac{0}{5}^{\circ}\text{C}$ and then at

- $t^{\circ}\text{C}$, where t is the temperature according to the T -marking;
- 55°C , for devices without a T -marking.

During the test the **off position** shall be maintained.

A test voltage of 500 V is applied across the contacts for 1 min. No breakdown shall occur.

24.102 Thermal cut-outs incorporated in **food dehydrators** for compliance with 19.4 shall not be self-resetting.

Compliance is checked by inspection.

25 Supply connection and external flexible cords

This clause of Part 1 is applicable except as follows.

25.1 Addition:

Appliances incorporating an appliance inlet that does not comply with the standard sheets of IEC 60320-1 shall be supplied with a cord set.

25.7 Addition:

The **supply cord** of appliances intended for outdoor use shall be polychloroprene sheathed.

26 Terminals for external conductors

This clause of Part 1 is applicable.

27 Provision for earthing

This clause of Part 1 is applicable except as follows.

27.1 Addition:

Earthing continuity shall not depend upon flexible metallic tubes, coiled springs or cord anchorages.

28 Screws and connections

This clause of Part 1 is applicable.

29 Clearances, creepage distances and solid insulation

This clause of Part 1 is applicable except as follows.

29.2 Addition:

The microenvironment is pollution degree 3 unless the insulation is enclosed or located so that it is unlikely to be exposed to pollution during normal use of the appliance.

29.3 Addition:

This requirement does not apply to the sheath of a **visibly glowing heating element** that is inaccessible to test probe 41 of IEC 61032.

30 Resistance to heat and fire

This clause of Part 1 is applicable except as follows.

30.1 Addition:

Temperature rises occurring during the test of 19.101 are not taken into account.

30.2 Addition:

The tests of 30.2.3 are applicable to

- **breadmakers;**
- **food dehydrators**
- *the following appliances if they incorporate a timer or if their instructions indicate a cooking operation longer than 1 h:*
 - **cookers;**
 - **ovens;**
 - **roasters;**
 - **rotary grills.**

For other appliances, the tests of 30.2.2 are applicable.

31 Resistance to rusting

This clause of Part 1 is applicable except as follows.

Addition:

For appliances intended for outdoor use, compliance is checked by the salt mist test, Kb of IEC 60068-2-52, severity 2 being applicable.

Before the test, enclosures having a coating are scratched by means of a hardened steel pin, the end of which has the form of a cone with a top angle of 40°. Its tip is rounded with a radius of 0,25 mm ± 0,02 mm. The pin is loaded so that the force exerted along its axis is 10 N ± 0,5 N. The pin is held at an angle of 80°– 85° to the horizontal and scratches are made by drawing the pin along the surface of the coating at a speed of approximately 20 mm/s. Five scratches are made at least 5 mm apart and at least 5 mm from the edges.

After the test, the appliance shall not have deteriorated to such an extent that compliance with this standard, in particular with Clauses 8 and 27, is impaired. The coating shall not be broken and shall not have loosened from the surface.

32 Radiation, toxicity and similar hazards

This clause of Part 1 is applicable.

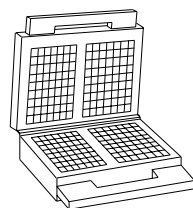

A

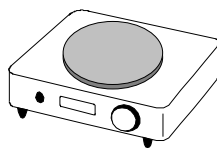

B

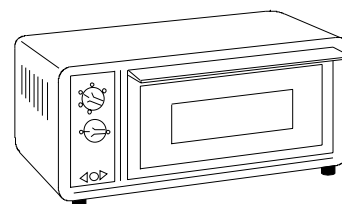

C

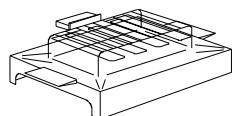

D

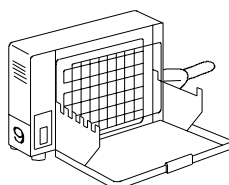

E

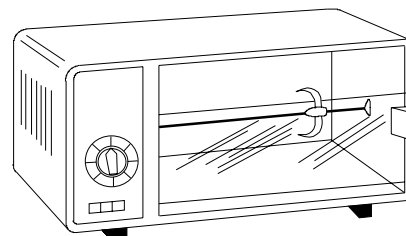

F

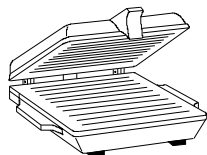

G



H

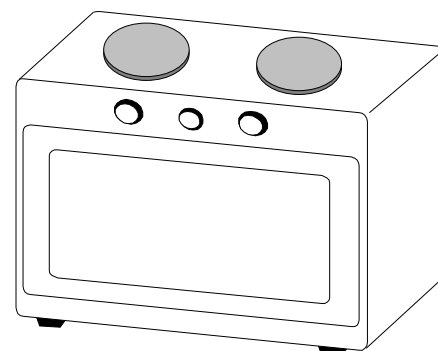

I

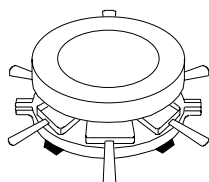

J

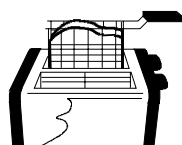

K

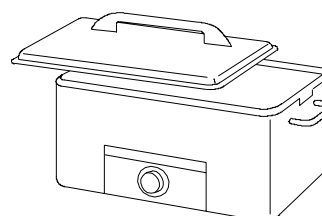

L

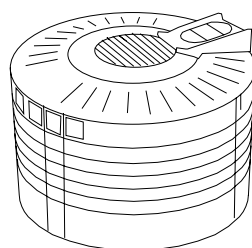

M

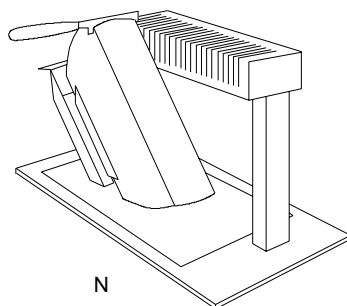

N

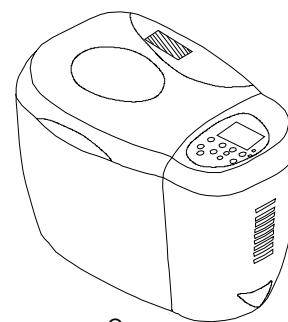

O

Key

A Waffle iron
 B Hotplate
 C Oven
 D Barbecue
 E Radiant grill
 F Rotary grill
 G Contact grill

H Griddle
 I Cooker
 J Raclette grill
 K Toaster and sandwich-toasting attachment
 L Roaster
 M Food dehydrator
 N Raclette appliance
 O Breadmaker

IEC 161/04

Figure 101 – Examples of appliances

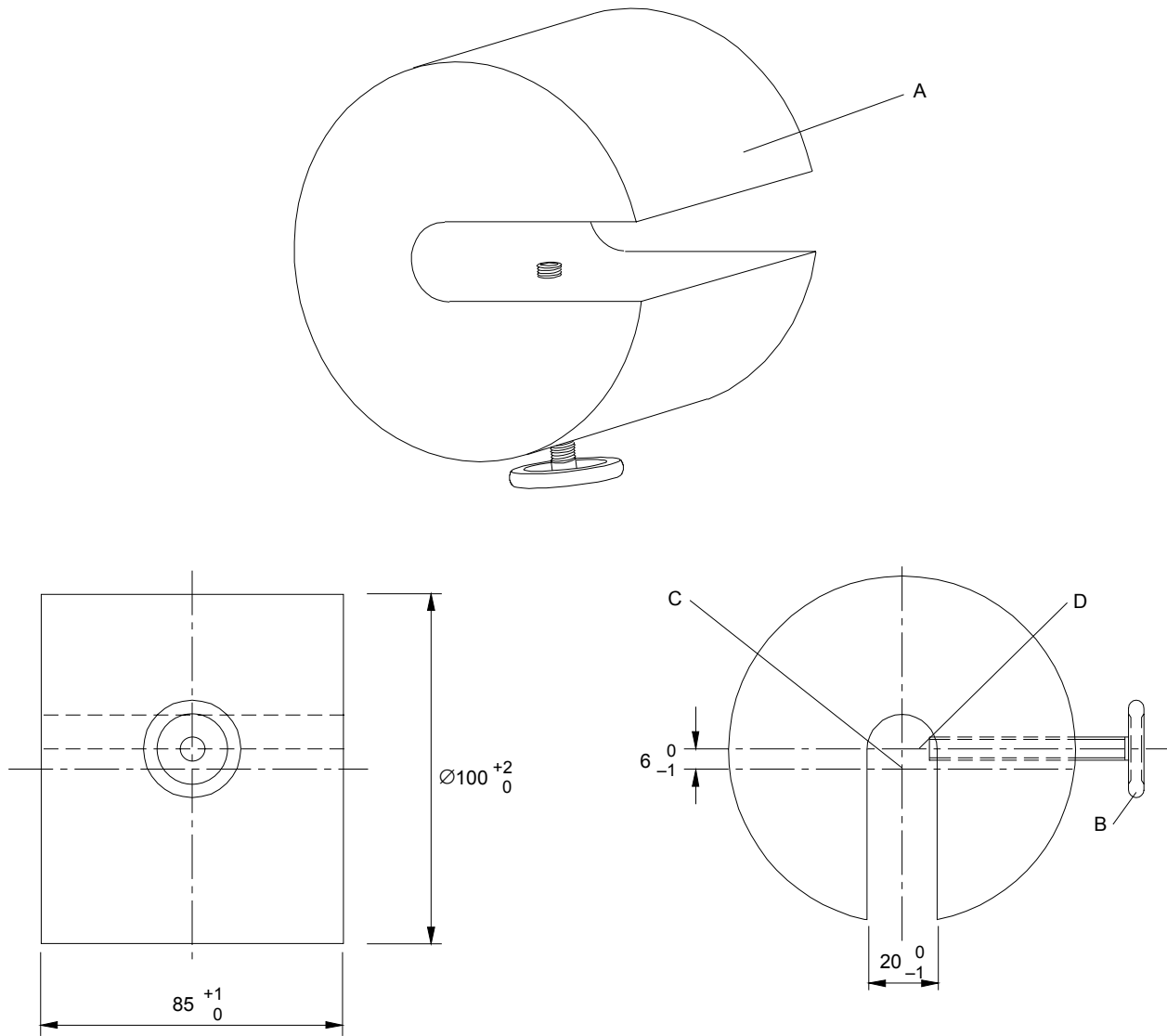

IEC 804/02

Dimensions in millimetres

Key

- A Load, mass approximately 4,5 kg
- B Fixing screw
- C Axis of load
- D Axis of fixing screw

NOTE The load is positioned on the rotary spit so that the fixing screw contacts the diameter of the spit.

Figure 102 – Load for testing rotating spits

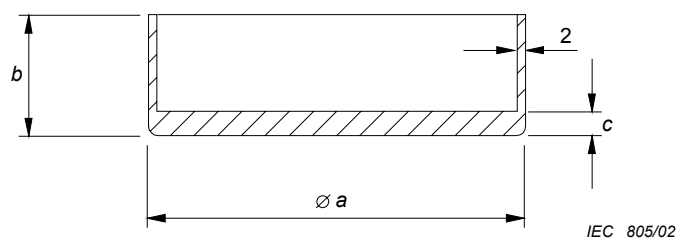

Dimensions in millimetres

Diameter of cooking zone mm	Approximate dimension		
	a mm	b mm	c mm
≤ 110	110	140	8
$>110 \leq 145$	145	140	8
$>145 \leq 180$	180	140	9
$>180 \leq 220$	220	120	10
$>220 \leq 300$	300	100	10

NOTE The maximum concavity of the vessel is to be not more than 0,05 mm. The base of the vessel is not to be convex.

Figure 103 – Vessel for testing hotplates

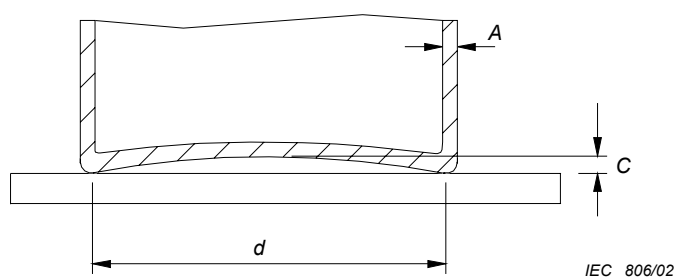

Key

- A Base and wall thickness, 2 mm \pm 0,5 mm
- C Maximum concavity
- d Diameter of the flat area of the base

NOTE The vessel is made of low carbon steel having a maximum carbon content of 0,08 %. It is cylindrical without metallic handles or protrusions. The diameter of the flat area of the base of the vessel is to be at least the diameter of the **cooking zone**. The maximum concavity of the base of the vessel is 0,006 d. The base of the vessel is not to be convex.

Figure 104 – Vessel for testing induction hotplates

Annexes

The annexes of Part 1 are applicable except as follows.

Annex C (normative)

Ageing test on motors

Modification:

The value of p in Table C.1 is 2 000.

Bibliography

The bibliography of Part 1 is applicable except as follows.

Addition:

IEC 60335-2-6, *Household and similar electrical appliances – Safety – Part 2-6: Particular requirements for stationary cooking ranges, hobs, ovens and similar appliances*

IEC 60335-2-12, *Household and similar electrical appliances – Safety – Part 2-12: Particular requirements for warming plates and similar appliances*

IEC 60335-2-13, *Household and similar electrical appliances – Safety – Part 2-13: Particular requirements for deep fat fryers, frying pans and similar appliances*

IEC 60335-2-25, *Household and similar electrical appliances – Safety – Part 2-25: Particular requirements for microwave ovens*

IEC 60335-2-78, *Household and similar electrical appliances – Safety – Part 2-78: Particular requirements for outdoor barbecues*



Standards Survey

The IEC would like to offer you the best quality standards possible. To make sure that we continue to meet your needs, your feedback is essential. Would you please take a minute to answer the questions overleaf and fax them to us at +41 22 919 03 00 or mail them to the address below. Thank you!

Customer Service Centre (CSC)

International Electrotechnical Commission

3, rue de Varembé
1211 Genève 20
Switzerland

or

Fax to: **IEC/CSC** at +41 22 919 03 00

Thank you for your contribution to the standards-making process.

A Prioritaire

Nicht frankieren
Ne pas affranchir



Non affrancare
No stamp required

RÉPONSE PAYÉE

SUISSE

Customer Service Centre (CSC)
International Electrotechnical Commission
3, rue de Varembé
1211 GENEVA 20
Switzerland



Q1 Please report on **ONE STANDARD** and **ONE STANDARD ONLY**. Enter the exact number of the standard: (e.g. 60601-1-1)

.....

Q2 Please tell us in what capacity(ies) you bought the standard (tick all that apply). I am the/a:

- purchasing agent
- librarian
- researcher
- design engineer
- safety engineer
- testing engineer
- marketing specialist
- other.....

Q3 I work for/in/as a: (tick all that apply)

- manufacturing
- consultant
- government
- test/certification facility
- public utility
- education
- military
- other.....

Q4 This standard will be used for: (tick all that apply)

- general reference
- product research
- product design/development
- specifications
- tenders
- quality assessment
- certification
- technical documentation
- thesis
- manufacturing
- other.....

Q5 This standard meets my needs: (tick one)

- not at all
- nearly
- fairly well
- exactly

Q6 If you ticked NOT AT ALL in Question 5 the reason is: (tick all that apply)

- standard is out of date
- standard is incomplete
- standard is too academic
- standard is too superficial
- title is misleading
- I made the wrong choice
- other

Q7 Please assess the standard in the following categories, using the numbers:

- (1) unacceptable,
- (2) below average,
- (3) average,
- (4) above average,
- (5) exceptional,
- (6) not applicable

- timeliness.....
- quality of writing.....
- technical contents.....
- logic of arrangement of contents
- tables, charts, graphs, figures.....
- other

Q8 I read/use the: (tick one)

- French text only
- English text only
- both English and French texts

Q9 Please share any comment on any aspect of the IEC that you would like us to know:

.....

.....

.....

.....

.....

.....

.....

.....

.....

.....



.....

.....

ISBN 2-8318-7406-8



9 782831 874067

ICS 97.040.50; 13.120

Typeset and printed by the IEC Central Office
GENEVA, SWITZERLAND