



ASSOCIATION CONNECTING  
ELECTRONICS INDUSTRIES

---

# IPC-6012A with Amendment 1

Qualification and Performance  
Specification for Rigid  
Printed Boards

**IPC-6012A  
with Amendment 1**

July 2000

A standard developed by IPC

---

Supersedes IPC-6012A  
October 1999

2215 Sanders Road, Northbrook, IL 60062-6135  
Tel. 847.509.9700 Fax 847.509.9798  
[www.ipc.org](http://www.ipc.org)

---

## The Principles of Standardization

In May 1995 the IPC's Technical Activities Executive Committee adopted Principles of Standardization as a guiding principle of IPC's standardization efforts.

### Standards Should:

- Show relationship to Design for Manufacturability (DFM) and Design for the Environment (DFE)
- Minimize time to market
- Contain simple (simplified) language
- Just include spec information
- Focus on end product performance
- Include a feedback system on use and problems for future improvement

### Standards Should Not:

- Inhibit innovation
- Increase time-to-market
- Keep people out
- Increase cycle time
- Tell you how to make something
- Contain anything that cannot be defended with data

## Notice

IPC Standards and Publications are designed to serve the public interest through eliminating misunderstandings between manufacturers and purchasers, facilitating interchangeability and improvement of products, and assisting the purchaser in selecting and obtaining with minimum delay the proper product for his particular need. Existence of such Standards and Publications shall not in any respect preclude any member or nonmember of IPC from manufacturing or selling products not conforming to such Standards and Publication, nor shall the existence of such Standards and Publications preclude their voluntary use by those other than IPC members, whether the standard is to be used either domestically or internationally.

Recommended Standards and Publications are adopted by IPC without regard to whether their adoption may involve patents on articles, materials, or processes. By such action, IPC does not assume any liability to any patent owner, nor do they assume any obligation whatever to parties adopting the Recommended Standard or Publication. Users are also wholly responsible for protecting themselves against all claims of liabilities for patent infringement.

## IPC Position Statement on Specification Revision Change

It is the position of IPC's Technical Activities Executive Committee (TAEC) that the use and implementation of IPC publications is voluntary and is part of a relationship entered into by customer and supplier. When an IPC standard/guideline is updated and a new revision is published, it is the opinion of the TAEC that the use of the new revision as part of an existing relationship is not automatic unless required by the contract. The TAEC recommends the use of the latest revision.  
Adopted October 6, 1998

## Why is there a charge for this standard?

Your purchase of this document contributes to the ongoing development of new and updated industry standards. Standards allow manufacturers, customers, and suppliers to understand one another better. Standards allow manufacturers greater efficiencies when they can set up their processes to meet industry standards, allowing them to offer their customers lower costs.

IPC spends hundreds of thousands of dollars annually to support IPC's volunteers in the standards development process. There are many rounds of drafts sent out for review and the committees spend hundreds of hours in review and development. IPC's staff attends and participates in committee activities, typesets and circulates document drafts, and follows all necessary procedures to qualify for ANSI approval.

IPC's membership dues have been kept low in order to allow as many companies as possible to participate. Therefore, the standards revenue is necessary to complement dues revenue. The price schedule offers a 50% discount to IPC members. If your company buys IPC standards, why not take advantage of this and the many other benefits of IPC membership as well? For more information on membership in IPC, please visit [www.ipc.org](http://www.ipc.org) or call 847/790-5372.

Thank you for your continued support.



ASSOCIATION CONNECTING  
ELECTRONICS INDUSTRIES

**IPC-6012A with Amendment 1**

# **Qualification and Performance Specification for Rigid Printed Boards**

Developed by the Rigid Board Performance Specifications Task Group  
(D-33a) of the Rigid Printed Board Committee (D-30) of IPC

Users of this standard are encouraged to participate in the  
development of future revisions.

Contact:

IPC  
2215 Sanders Road  
Northbrook, Illinois  
60062-6135  
Tel 847 509.9700  
Fax 847 509.9798

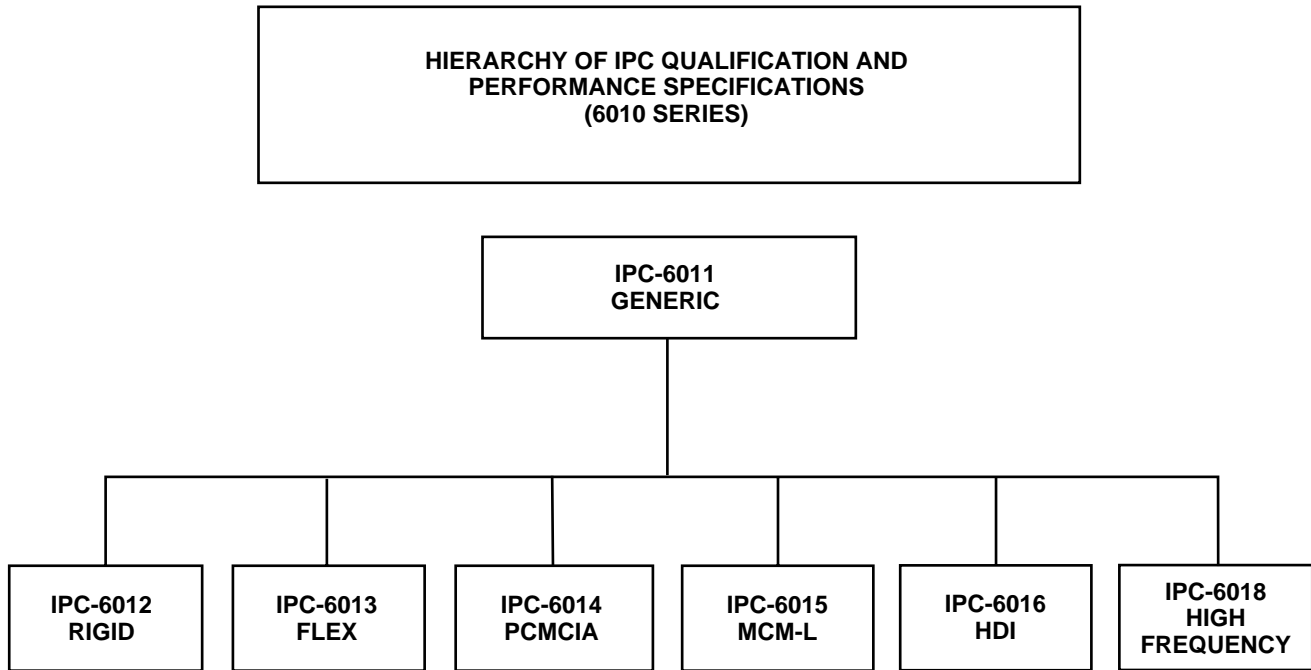

#### **FOREWORD**

This specification is intended to provide information on the detailed performance criteria of rigid printed boards. It supersedes IPC-RB-276 and IPC-6012 and was developed as a revision to those documents. The information contained herein is also intended to supplement the generic requirements identified in IPC-6011. When used together, these documents should lead both manufacturer and customer to consistent terms of acceptability.

IPC's documentation strategy is to provide distinct documents that focus on specific aspects of electronic packaging issues. In this regard, document sets are used to provide the total information related to a particular electronic packaging topic. A document set is identified by a four digit number that ends in zero (0) (i.e., IPC-6010).

Included in the set is the generic information, which is contained in the first document of the set. The generic specification is supplemented by one or multiple performance documents, each of which provide a specific focus on one aspect of the topic or the technology selected.

Failure to have all information available prior to building a board may result in a conflict in terms of acceptability.

As technology changes, a performance specification will be updated, or new focus specifications will be added to the document set. The IPC invites input on the effectiveness of the documentation and encourages user response through completion of "Suggestions for Improvement" forms located at the end of each document.

## Acknowledgment

Any Standard involving a complex technology draws material from a vast number of sources. While the principal members of the Rigid Board Performance Specifications Task Group (D-33a) of the Rigid Printed Board Committee (D-30) are shown below, it is not possible to include all of those who assisted in the evolution of this standard. To each of them, the members of the IPC extend their gratitude.

<b>Rigid Printed Board Committee</b>	<b>Rigid Board Performance Specifications Task Group</b>	<b>Technical Liaison of the IPC Board of Directors</b>
Chair C. Don Dupriest Lockheed Martin Missiles and Space	Chair Lisa Greenleaf Teradyne Connection System	Stan Plzak     Peter Bigelow Pensar Corp.     Beaver Brook Circuits

### **Rigid Board Performance Specifications Task Group**

Robyn L. Aagesen, Hadco Corp.	Christopher Conklin, Lockheed Martin Corp.	George S. Gerberick, Velie Circuits Inc.
Dale E. Aldrich, Rockwell Collins	David J. Corbett, Defense Supply Center Columbus	Becky A. Gillmouth, Merix Corporation
Masamitsu Aoki, Toshiba Chemical Corp.	Edward C. Couble, Shipley Co. L.L.C.	Robert J. Gordon, Ford Motor Co.
Ivan E. Araktingi, AlliedSignal Laminate Systems	Frank D. Cox, Trace Laboratories - East	Lisa A. Greenleaf, Teradyne Connection System
Jerry Arreola, PairGain Technologies	Charles Dal Currier, Ambitech Inc.	Russell S. Griffith, Tyco PCG/Engineered Systems
Lance A. Auer, Raytheon Missile Systems Company	Mukesh Dave, Lucent Technologies Inc.	Grover Guerra, DSC Communications Corporation
Richard A. Barnett, Compaq Computer Corporation	Michele J. DiFranza, The Mitre Corp.	Andrew J. Heidelberg, Micron Technology Inc.
Martin W. Bayes, Shipley Co. L.L.C.	Joe Dhirkop, Defense Supply Center Columbus	Adam E. Hen, Celestica Inc.
Mary E. Bellon, Hughes Space & Communications Co.	Fern Dove, Basic Electronics Incorporated	Aram Henesian, Basic Electronics Incorporated
Erik J. Bergum, Polyclad Laminates Inc.	C. Don Dupriest, Lockheed Martin Missiles and Space	Steven A. Herrberg, Raytheon Systems Company
John-Paul Besong, Rockwell Collins	Frank Durso, MacDermid Inc.	Ralph J. Hersey, Ralph Hersey & Associates
Robert J. Black, Northrop Grumman ES&SD	Theodore Edwards, Honeywell Inc. Air Transport Sys	Phillip E. Hinton, Hinton -PWB-Engineering
Paul Boudreau, Raytheon Systems Company	Philip J. Elias, Honeywell Inc. Air Transport Sys	Kazuo Hirasaka, Eastern Company Ltd.
Vern Bradshaw, Microtek Laboratories	Werner Engelmaier, Engelmaier Associates	Robert R. Holmes, Interconnection Technology Resea
Mark Buechner, Teradyne Connection Systems	Donna R. Fawcett, Hadco Santa Clara Inc.	Lorraine Hook, Dynamic Details Inc.
Lewis Burnett, Honeywell Inc. BCAS	Terry M. Fischer, Hitachi Chemical Co. America	Les Hymes, Les Hymes Associates
Dennis J. Cantwell, Printed Circuits Inc.	Martin G. Freedman, Molex Inc.	Octavian Iordache, Viasystems Canada Inc.
Thomas A. Carroll, Hughes Space & Communications Co	Mahendra S. Gandhi, Raytheon Systems Company	William I. Jacobi, Sheldahl Inc.
Pei-Liang Chen, Shanghai Printronics Circuit	Floyd L. Gentry, Sandia National Labs Albuquerque	Ted J. Jones, NSWC - Crane
Kevin Y. Chen, 3M Company		Roy M. Keen, Rockwell Collins
Steve Collins, ANTEC International Corporation		Cindy A. Kemp, Evenflo Company Inc.

---

Thomas E. Kemp, Rockwell Collins	Kelly J. Miller, CAE Electronics Ltd.	Karl A. Sauter, Sun Microsystems Inc.
Young J. Kim, Yamamoto Manufacturing (USA) Inc	Joseph L. Mulcahy, Methode Electronics Inc. East	Roddy L. Scherff, Tyco Printed Circuits
Edward Knowles, Lockheed Martin Astronautics	Suzanne F. Nachbor, Honeywell Inc.	Kenneth C. Selk, TRW
George T. Kotecki, Northrop Grumman Corporation	Bob Neves, Microtek Laboratories	Lowell Sherman, Defense Supply Center Columbus
Richard L. Williams, Boeing Phantom Works	William A. Ortloff, B/C Engineering	John L. Stephens, Ambitech Inc.
Leo P. Lambert, EPTAC Corporation	Nitin B. Parekh, Unisys Corporation	David D. Sullivan, Rockwell Collins
Clifford H. Lamson, Harris Corporation	Ron Payne, Primex Aerospace Company	Joseph T. Slanina, Honeywell, Inc.
Roger H. Landolt, Enthone-OMI Inc.	Nat Perkinson, BroadBand Technologies Inc.	Avtar S. Takhar, Xerox Corporation
Douglas M. Laws, Viasystems Technologies Corp.	Richard Peyton, Lockheed Martin Astronautics	Daniel R. Tetter, Hughes Network Systems
Billy Lung, Lucent Technologies Inc/Bell Lab	Paul J. Quinn, Lockheed Martin	Ronald E. Thompson, NSWC - Crane
James F. Maguire, Intel Corporation	Michael R Green, Lockheed Martin Missiles & Space	George C. Toman, Circuit Center Inc.
Chris Mahanna, Robisan Laboratory Inc.	Allan Read, Celistica International Inc.	Ken Trude, Hadco Santa Clara Inc.
Wesley R. Malewicz, Siemens Medical Systems Inc.	Randy R. Reed, Merix Corporation	Robert Vanech
Susan S. Mansilla, Robisan Laboratory Inc.	Johnie Roberts, Rockwell Collins	Eric L. Vollmar, Graphic Research LLC
William Dean, May, NSWC - Crane	David Rooke, Viasystems Canada Inc.	William W. Ward, Raytheon Systems Company
Brian C. McCrory, Delsen Testing Labs	Mona L. Rudolph, Dynamic Circuits Inc.	Clark F. Webster, Precision Diversified Industries
Renee J. Michalkiewicz, Trace Laboratories - East	Jerry Ruiz, Velie Circuits Inc.	Thomas B. Woodward, Raytheon Systems Company
	David J. Russell, IBM Corp./Endicott Elect. Pkgng.	Wally Younger, Nelco Technology Inc.
	Earl S. Sauer, Viasystems Technologies Corp.	

# Table of Contents

<b>1</b>	<b>SCOPE</b>	1	3.3.8	Edge Board Contact, Junction of Gold Plate to Solder Finish	7
1.1	Scope	1	3.3.9	Workmanship	7
1.2	Purpose	1	3.4	Board Dimensional Requirements	7
1.3	Performance Classification and Type	1	3.4.1	Hole Size and Hole Pattern Accuracy	7
1.3.1	Classification	1	3.4.2	Annular Ring and Breakout (Internal)	7
1.3.2	Board Type	1	3.4.3	Annular Ring (External)	7
1.3.3	Selection for Procurement	1	3.4.4	Bow and Twist	8
1.3.4	Material, Plating Process and Final Finish	1	3.5	Conductor Definition	8
<b>2</b>	<b>APPLICABLE DOCUMENTS</b>	2	3.5.1	Conductor Width and Thickness	9
2.1	IPC	2	3.5.2	Conductor Spacing	9
2.2	Joint Industry Standards	3	3.5.3	Conductor Imperfections	9
2.3	Federal	3	3.5.4	Conductive Surfaces	10
2.4	Other Publications	3	3.6	Structural Integrity	11
2.4.1	American Society for Testing and Materials	3	3.6.1	Thermal Stress Testing	11
2.4.2	Underwriters Lab	3	3.6.2	Requirements for Microsectioned Coupons or Production Boards	11
2.4.3	National Electrical Manufacturers Association	3	3.7	Other Tests	14
2.4.4	American Society for Quality Control	3	3.7.1	Metal Core (Horizontal Microsection)	14
<b>3</b>	<b>REQUIREMENTS</b>	3	3.7.2	Rework Simulation	14
3.1	General	3	3.7.3	Bond Strength, Unsupported Component Hole Land	15
3.2	Materials Used in this Specification	3	3.8	Solder Resist (Solder Mask) Requirements	15
3.2.1	Laminates and Bonding Material for Multilayer Boards	3	3.8.1	Solder Resist Coverage	15
3.2.2	External Bonding Materials	4	3.8.2	Solder Resist Cure and Adhesion	15
3.2.3	Other Dielectric Materials	4	3.8.3	Solder Resist Thickness	15
3.2.4	Metal Foils	4	3.9	Electrical Requirements	16
3.2.5	Metal Core	4	3.9.1	Dielectric Withstanding Voltage	16
3.2.6	Metallic Platings and Coatings	4	3.9.2	Electrical Continuity and Insulation Resistance	16
3.2.7	Organic Solderability Preservative (OSP)	4	3.9.3	Circuit/Plated-Through Shorts to Metal Substrate	16
3.2.8	Polymer Coating (Solder Resist)	5	3.9.4	Moisture and Insulation Resistance (MIR)	16
3.2.9	Fusing Fluids and Fluxes	5	3.10	Cleanliness	17
3.2.10	Marking Inks	5	3.10.1	Cleanliness Prior to Solder Resist Application	17
3.2.11	Hole Fill Insulation Material	5	3.10.2	Cleanliness After Solder Resist, Solder, or Alternative Surface Coating Application	17
3.2.12	Heatsink Planes, External	5	3.10.3	Cleanliness of Inner Layers After Oxide Treatment Prior to Lamination	17
3.3	Visual Examination	5	3.11	Special Requirements	17
3.3.1	Edges	6	3.11.1	Outgassing	17
3.3.2	Laminate Imperfections	6	3.11.2	Organic Contamination	17
3.3.3	Plating and Coating Voids in the Hole	6	3.11.3	Fungus Resistance	17
3.3.4	Lifted Lands	6	3.11.4	Vibration	17
3.3.5	Marking	6			
3.3.6	Solderability	6			
3.3.7	Plating Adhesion	7			

3.11.5 Mechanical Shock ..... 17  
 3.11.6 Impedance Testing ..... 17  
 3.11.7 Coefficient of Thermal Expansion (CTE) ..... 18  
 3.11.8 Thermal Shock ..... 18  
 3.11.9 Surface Insulation Resistance  
 (As Received) ..... 18  
 3.12 Repair ..... 18  
 3.12.1 Circuit Repairs ..... 18  
 3.13 Rework ..... 18

**4 QUALITY ASSURANCE PROVISIONS ..... 18**

4.1 General ..... 18  
 4.1.1 Qualification ..... 18  
 4.1.2 Sample Test Coupons ..... 18  
 4.2 Acceptance Tests ..... 18  
 4.2.1 C=0 Sampling Plan ..... 18  
 4.2.2 Referee Tests ..... 23  
 4.3 Quality Conformance Testing ..... 23  
 4.3.1 Coupon Selection ..... 23

**5 NOTES ..... 23**

5.1 Ordering Data ..... 23  
 5.2 Superseded Specifications ..... 23

**APPENDIX A ..... 24**

**Figures**

Figure 3-1 Annular Ring Measurement ..... 8  
 Figure 3-2A Breakout of 90° and 180° ..... 8

Figure 3-2B Conductor Width Reduction ..... 8  
 Figure 3-3 Separations at External Foil ..... 10  
 Figure 3-4 Crack Definition ..... 10  
 Figure 3-5 Typical Microsection Evaluation Specimen  
 (Three Plated-Through Holes) ..... 13  
 Figure 3-6 Negative Etchback ..... 13  
 Figure 3-7 Metal Core to Plated-Through Hole  
 Spacing ..... 14

**Tables**

Table 1-1 Default Requirements ..... 1  
 Table 3-1 Metal Core Substrate ..... 4  
 Table 3-2 Final Finish, Surface Plating Coating  
 Requirements ..... 5  
 Table 3-3 Plating and Coating Voids Visual Examination ... 6  
 Table 3-4 Edge Board Contact Gap ..... 7  
 Table 3-5 Minimum Internal and External Annular Ring .... 8  
 Table 3-6 Plated-Through Hole Integrity After Stress ..... 9  
 Table 3-7 Internal Layer Foil Thickness After  
 Processing ..... 14  
 Table 3-8 External Conductor Thickness After Plating ..... 14  
 Table 3-9 Solder Resist Adhesion ..... 16  
 Table 3-10 Dielectric Withstanding Voltages ..... 16  
 Table 3-11 Insulation Resistance ..... 16  
 Table 4-1 Qualification Test Coupons ..... 19  
 Table 4-2 C=0 Sampling Plan (Sample Size for  
 Specific Index Value) ..... 19  
 Table 4-3 Acceptance Testing and Frequency ..... 20  
 Table 4-4 Quality Conformance Testing ..... 23



# Qualification and Performance Specification for Rigid Printed Boards

## 1 SCOPE

**1.1 Scope** This specification covers qualification and performance of rigid printed boards. The printed board may be single-sided, double-sided, with or without plated-through holes, multilayer with plated-through holes, multilayer with or without buried/blind vias, and metal core boards.

**1.2 Purpose** The purpose of this specification is to provide requirements for qualification and performance of rigid printed boards.

### 1.3 Performance Classification and Type

**1.3.1 Classification** This specification recognizes that rigid printed boards will be subject to variations in performance requirements based on end-use. The printed boards are classified by a Performance Class of 1, 2 or 3. Performance classes are defined in IPC-6011, Generic Performance Specification for Printed Boards.

**1.3.2 Board Type** Printed boards without plated-through holes (Type 1) and with plated-through holes (Types 2-6) are classified as follows:

*Type 1*—Single-Sided Board

*Type 2*—Double-Sided Board

*Type 3*—Multilayer board without blind or buried vias

*Type 4*—Multilayer board with blind and/or buried vias

*Type 5*—Multilayer metal core board without blind or buried vias

*Type 6*—Multilayer metal core board with blind and/or buried vias

**1.3.3 Selection for Procurement** For procurement purposes, performance class **shall** be specified in the procurement documentation.

The documentation **shall** provide sufficient information to the supplier so that he can fabricate the printed board and ensure that the user receives the desired product. Information that should be included in the procurement documentation is shown in IPC-D-325.

**1.3.3.1 Selection (Default)** The procurement documentation should specify the requirements that can be selected within this specification; however, in the event selections are not made in the documentation, Table 1-1 **shall** apply.

### 1.3.4 Material, Plating Process and Final Finish

**1.3.4.1 Laminate Material** Laminate material is identified by numbers and/or letters, classes, types as specified by the appropriate specification listed in the procurement documentation.

Table 1-1 Default Requirements

Category	Default Selection
Performance Class	Class 2
Material	Epoxy-Glass Laminate
Final Finish	Finish X (Electrodeposited tin-lead, fused or solder coated)
Minimum Starting Foil	1/2 oz. for all internal and external layers except Type 1 which <b>shall</b> start with 1 oz.
Copper Foil Type	Electrodeposited
Hole Diameter Tolerance Plated, components Plated, via only  Unplated	(±) 100 µm [0.0040 in] (+) 80 µm [0.0031 in], (-) no requirement, (may be totally or partially plugged) (±) 80 µm [0.0031 in]
Conductor Width tol.	Class 2 requirements per para. 3.5.1
Conductor Spacing tol.	Class 2 requirements per para. 3.5.2
Dielectric Separation	90 µm [0.0035 in] minimum
Lateral Conductor Spacing	100 µm [0.0040 in] minimum
Marking Ink	Contrasting color, nonconductive
Solder Resist	Not applied, if not specified
Solder Resist, specified	Class T of IPC-SM-840 if class not specified
Solderability Test	Category 2 of J-STD-003
Test Voltage, Insulation Resistance	40 Volts
Qualification not specified	See IPC-6011

**1.3.4.2 Plating Process** The copper plating process which is used to provide the main conductor in the holes is identified by one number as follows:

- 1 Acid copper electroplating only
- 2 Pyrophosphate copper electroplating only
- 3 Acid and/or pyrophosphate copper electroplating
- 4 Additive/electroless copper

**1.3.4.3 Final Finish** The final finish can be but is not limited to one of the finishes specified below or a combination of several platings and is dependent on assembly processes and end-use. Thickness, where required, **shall** be specified in the procurement documentation unless listed in Table 3-2. Coating thickness may be exempted in Table 3-2 (i.e., tin-lead plate or solder coating). Designators for final finish are as follows:

S	Solder Coating	(Table 3-2)
T	Electrodeposited Tin-Lead, (fused)	(Table 3-2)
X	Either Type S or T	(Table 3-2)
TLU	Electrodeposit Tin-Lead (unfused)	(Table 3-2)
G	Gold Electroplate for Edge Board Connectors	(Table 3-2)
GS	Gold Electroplate for Areas to be Soldered	(Table 3-2)
N	Nickel for Edge Board Connectors	(Table 3-2)
NB	Nickel as a Barrier to Copper-Tin Diffusion	(Table 3-2)
OSP	Organic Solderability Protector (tarnish and sol- derability protection during storage and assem- bly processes)	(Table 3-2)
C	Bare Copper	(Table 3-2)
SMOBC	Solder Mask over Bare Copper	
EN	Electroless Nickel	
EG	Electroless Gold	
IG	Immersion Gold	
IS	Immersion Silver	
IT	Immersion Tin	
TN	Tin-Nickel	
R	Rhodium	
P	Palladium	
TP	Tin Plating	
Y	Other	

## 2 APPLICABLE DOCUMENTS

The following specifications of the revision in effect at the time of order form a part of this document to the extent specified herein. If a conflict of requirements exists between IPC-6012 and the listed applicable documents, IPC-6012 **shall** take precedence.

### 2.1 IPC<sup>1</sup>

**IPC-T-50** Terms and Definitions for Interconnecting and Packaging Electronic Circuits

**IPC-DD-135** Qualification for Deposited Organic Inter-layer Dielectric Materials for Multichip Modules

**IPC-CF-148** Resin Coated Metal for Printed Boards

**IPC-CF-152** Composite Material Specifications for Printed Wiring Boards

**IPC-FC-232** Adhesive Coated Dielectric Films for Use as Cover Sheets for Flexible Printed Wiring and Flexible Bonding Films

**IPC-D-325** Documentation Requirements for Printed Boards, Assemblies, and Support Drawings

**IPC-A-600** Acceptability of Printed Boards

**IPC-AI-642** User Guideline for Automated Inspection of Artwork, Innerlayer and Unpopulated PWBs

**IPC-TM-650** Test Methods Manual<sup>2</sup>

2.1.1D 03/98 Microsectioning

2.1.1.2 07/93 Microsectioning, Semi or Automatic Technique Microsection Equipment (Alternate)

2.3.15C 08/92 Purity, Copper Foil or Plating

2.3.25B 08/97 Detection and Measurement of Ionizable Surface Contaminants

2.3.38B 08/97 Surface Organic Contaminant Detection Test

2.3.39B 08/97 Surface Organic Contaminant Identification Test (Infrared Analytical Method)

2.4.1D 08/97 Adhesion, Tape Testing

2.4.18.1 08/97 Tensile Strength and Elongation, In-House Plating

2.4.21D 08/97 Land Bond Strength, Unsupported Component Hole

2.4.22C 06/99 Bow and Twist

2.4.28.1C 03/98 Adhesion, Solder Resist (Mask), Tape Test Method

2.4.36B 08/97 Rework Simulation, Plated-Through Holes for Leaded Components

2.4.41.2 08/97 Coefficient of Thermal Expansion, Strain Gage Method

2.5.5.7 11/92 Characteristic Impedance and Time Delay of Lines on Printed Boards by TDR

2.5.7C 08/97 Dielectric Withstand Voltage, PWB

2.6.1E 08/97 Fungus Resistance, Printed Wiring Materials

2.6.3E 08/97 Moisture and Insulation Resistance, Rigid Boards

2.6.4A 08/97 Outgassing, Printed Boards

2.6.5C 08/97 Physical Shock, Multilayer Printed Wiring

1. IPC, 2215 Sanders Road, Northbrook, IL 60062-6135.

2. Current and revised IPC Test Methods are available through IPC-TM-650 subscription and on the IPC Web site ([www.ipc.org/html/testmethods.htm](http://www.ipc.org/html/testmethods.htm)).

- 2.6.7.2A 08/97 Thermal Shock, Continuity and Micro-section, Printed Boards
- 2.6.8D 03/98 Thermal Stress, Plated-Through Holes
- 2.6.9A 08/97 Vibration, Rigid Printed Wiring

**IPC-ET-652** Guidelines and Requirements for Electrical Testing of Unpopulated Printed Boards

**IPC-QL-653** Certification of Facilities that Inspect/Test Printed Wiring Boards, Components and Materials

**IPC-CC-830** Qualification and Performance of Electrical Insulating Compound for Printed Board Assemblies

**IPC-SM-840** Qualification and Performance of Permanent Solder Mask

**IPC-2221** Generic Standard on Printed Board Design

**IPC-4101** Specification for Base Materials for Rigid and Multilayer Printed Boards

**IPC-4562** Metal Foil for Printed Wiring Applications

**IPC-6011** Generic Performance Specification for Printed Boards

**IPC-6015** Qualification and Performance Specification for Organic Multichip Module (MCM-L) Mounting and Interconnecting Structures

**IPC-7721** Repair and Modification of Printed Boards and Electronic Assemblies

**IPC-100002** Universal Drilling and Profile Master Drawing

**IPC-100047** Composite Test Pattern Basic Dimension Drawing-Ten Layer

**IPC-100101** Master Drawing, Capability Test Board (Single Sided)

**IPC-100102** Master Drawing, Capability Test Board (Double Sided)

**IPC-100103** Master Drawing, Capability Test Board (Ten Layer Multilayer Board without Blind or Buried Vias)

## 2.2 Joint Industry Standards<sup>1</sup>

**J-STD-003** Solderability Tests for Printed Boards

**J-STD-006** Requirements for Electronic Grade Solder Alloys and Fluxed and Non-Fluxed Solid Solders for Electronic Soldering Applications

## 2.3 Federal<sup>3</sup>

**QQ-A-250** Aluminum Alloy, Plate and Sheet

**QQ-N-290** Nickel Plating

**QQ-S-635** Steel

## 2.4 Other Publications

### 2.4.1 American Society for Testing and Materials<sup>4</sup>

**ASTM B-152** Standard Specification for Copper Sheet, Strip, Plate and Rolled Bar

**ASTM B-488** Standard Specification for Electrodeposited Coatings of Gold for Engineering Uses

**ASTM B-579** Standard Specification for Electrodeposited Coating of Tin-Lead Alloy (Solder Plate)

### 2.4.2 Underwriters Lab<sup>5</sup>

**UL 94** Tests for Flammability of Plastic Materials for Parts in Devices and Appliances

### 2.4.3 National Electrical Manufacturers Association<sup>6</sup>

**NEMA LI-1** Industrial Laminate Thermosetting Product

### 2.4.4 American Society for Quality Control<sup>7</sup>

**H0862** Zero Acceptance Number Sampling Plans

## 3 REQUIREMENTS

**3.1 General** Printed boards furnished under this specification **shall** meet or exceed the requirements of IPC-6011 and the specific performance class as required by the procurement documentation. Descriptions and purposes of test coupons are documented in IPC-2221.

### 3.2 Materials Used in this Specification

**3.2.1 Laminates and Bonding Material for Multilayer Boards** Rigid metal clad laminates, rigid unclad laminates and bonding material (prepreg) should be selected from IPC-4101, IPC-FC-232, or NEMA LI-1. The specification sheet number, metal cladding type and metal clad thickness (weight) **shall** be as specified in the procurement

3. Standardization Documents Order Desk, Building 4D, 700 Robbins Avenue, Philadelphia, PA 19111-5094.

4. ASTM, 100 Barr Harbor Drive, West Conshohocken, PA 19428.

5. Underwriters Lab, 333 Pfingsten Road, Northbrook, IL 60062.

6. NEMA, 1300 North 17th Street, Suite 1847, Rosslyn, VA 22209.

7. ASQC, 230 West Wells Street, Milwaukee, WI 53203.

documentation. When specific requirements such as the flammability requirements shown in UL 94 for laminate and bonding materials are required, it is necessary to specify those requirements in material procurement documents.

**3.2.2 External Bonding Materials** The material used to adhere external heat sinks or stiffeners to the printed board **shall** be selected from IPC-4101, IPC-FC-232 or as specified in the procurement documentation.

**3.2.3 Other Dielectric Materials** Photoimageable dielectrics should be selected from IPC-DD-135 and specified in the procurement documentation. Other dielectric materials may be specified in the procurement documentation.

**3.2.4 Metal Foils** Copper foil **shall** be in accordance with IPC-4562. Foil type, foil grade, foil thickness, bond enhancement treatment and foil profile should be specified on the master drawing if critical to the function of the printed board. Resin coated copper foil **shall** be in accordance with IPC-CF-148. Resistive metal foil **shall** be in accordance with the applicable specification and the procurement documents.

**3.2.5 Metal Core** The metal core substrate **shall** be specified on the master drawing as shown in Table 3-1.

**Table 3-1 Metal Core Substrate**

Material	Specification	Alloy
Aluminum	QQ-A-250	As specified
Steel	QQ-S-635	As specified
Copper	ASTM-B-152 or IPC-4562	As specified
Copper-Invar-Copper	IPC-CF-152	As specified
Copper-Moly-Copper	IPC-CF-152	As specified
Other	As specified	

**3.2.6 Metallic Platings and Coatings** Thickness of the plating/coating **shall** be in accordance with Table 3-2. The copper plating thickness on the surface, in plated-through holes, via holes and in blind and buried vias **shall** be as specified in Table 3-2. Thickness of platings for a specific use is shown in Table 3-2. Final finishes selected from those listed in 1.3.4.3 or combinations required **shall** specify plating thickness except for fused tin-lead plating or solder coating which requires visual coverage and acceptable solderability testing per J-STD-003. Coverage of platings and metallic coatings does not apply to vertical conductor edges; conductor surfaces may have exposed copper in areas not to be soldered within the limits of 3.5.4.6.

**Note:** The Category of solderability testing **shall** be specified by the user per J-STD-003; however, in the event it is not specified the supplier **shall** test to Category 2 (steam aging is not required).

**3.2.6.1 Electroless Depositions and Conductive Coatings** Electroless depositions and conductive coatings **shall** be sufficient for subsequent plating process and may be either electroless metal, vacuum deposited metal, or metallic or nonmetallic conductive coatings.

**3.2.6.2 Additive Copper Depositions** Additive/electroless copper platings applied as the main conductor metal **shall** meet the requirements of this specification.

**3.2.6.3 Tin-Lead** Tin-lead plating **shall** meet the composition (50-70% tin) requirements of ASTM B-579. Fusing is required unless the unfused option is selected wherein the thickness specified in Table 3-2 applies.

**3.2.6.4 Solder Coating** The solder used for solder coating **shall** be Sn60A, Sn60C, Pb40A, Pb36A, Pb36B, Pb36C, Sn63A, Sn63C or Pb37A per J-STD-006.

**3.2.6.5 Nickel** Nickel plating **shall** be in accordance with QQ-N-290 Class 2, except the thickness **shall** be in accordance with Table 3-2.

**3.2.6.6 Gold Plating** Electrodeposited gold plating **shall** be in accordance with ASTM-B-488. Class and Type **shall** be specified in the procurement documentation. For Class 3 boards, gold plating **shall** be Type 1 or 3, Class 1.25.

Gold plating thickness on areas to be wire bonded **shall** be as specified in the procurement documentation (see IPC-6015, for example).

**3.2.6.7 Other** Other depositions such as bare copper, electroless nickel, immersion gold, immersion silver, palladium, rhodium, tin, 95Sn/5Pb etc. may be used provided they are specified in the procurement documentation.

**3.2.6.8 Electrodeposited Copper** When specified, electrodeposited copper platings **shall** meet the following criteria. Frequency of testing shall be determined by the manufacturer to ensure compliance.

- When tested as specified in IPC-TM-650, Method 2.3.15, the purity of copper **shall** be no less than 99.50% for either pyrophosphate or acid copper.
- When tested as specified in IPC-TM-650, Method 2.4.18.1, at ambient temperature using 50 - 100  $\mu\text{m}$  [0.0020 in - 0.003937 in] thick samples, the tensile strength **shall** be no less than 36,000 PSI [248 MPa] and the elongation **shall** be no less than 12%.

**3.2.7 Organic Solderability Preservative (OSP)** OSPs are anti-tarnish and solderability protectors applied to bare copper to withstand storage and assembly processes in order to maintain solderability of surfaces. The coating

**Table 3-2 Final Finish, Surface<sup>1</sup> Plating Coating Requirements**

Finish	Class 1	Class 2	Class 3
Gold (min) for edge-board connectors and areas not to be soldered	0.8 µm [0.00003 in]	0.8 µm [0.00003 in]	1.25 µm [0.00004921 in]
Gold (max) on areas to be soldered	0.8 µm [0.00003 in]	0.8 µm [0.00003 in]	0.8 µm [0.00003 in]
Nickel (min) for edgeboard connectors	2.0 µm [0.00008 in]	2.5 µm [0.00010 in]	2.5 µm [0.00010 in]
Nickel (min) <sup>2</sup> barrier to prevent formation of copper-tin compounds	1.0 µm [0.00004 in]	1.3 µm [0.00005 in]	1.3 µm [0.00005 in]
Unfused tin-lead (min)	8.0 µm [0.0003 in]	8.0 µm [0.0003 in]	8.0 µm [0.0003 in]
Fused tin-lead or Solder Coat	Coverage and Solderable	Coverage and Solderable	Coverage and Solderable
Solder Coat over Bare Copper	Coverage and Solderable	Coverage and Solderable	Coverage and Solderable
Organic Solderability Preservative	Solderable	Solderable	Solderable
Bare Copper	None	None	None
Surface and Holes			
Copper <sup>1</sup> (min. avg.)	20 µm [0.00079 in]	20 µm [0.00079 in]	25 µm [0.00098 in]
Min. thin areas <sup>3</sup>	18 µm [0.00071 in]	18 µm [0.00071 in]	20 µm [0.00079 in]
Blind Vias			
Copper (min. avg.)	20 µm [0.00079 in]	20 µm [0.00079 in]	25 µm [0.00098 in]
Min. thin area	18 µm [0.00071 in]	18 µm [0.00071 in]	20 µm [0.00079 in]
Low Aspect Ratio Blind Vias <sup>4</sup>			
Copper (min. avg.)	12 µm [0.00047 in]	12 µm [0.00047 in]	12 µm [0.00047 in]
Min. thin area	10 µm [0.00040 in]	10 µm [0.00040 in]	10 µm [0.00040 in]
Buried Vias			
Copper (min. avg.)	13 µm [0.00051 in]	15 µm [0.00060 in]	15 µm [0.00060 in]
Min. thin area	11 µm [0.00043 in]	13 µm [0.00051 in]	13 µm [0.00051 in]

<sup>1</sup> Copper plating thickness applies to surfaces and hole walls.

<sup>2</sup> Nickel platings used under the tin-lead or solder coating for high temperature operating environments act as a barrier to prevent the formation of copper-tin compounds.

<sup>3</sup> For Class 3 boards having a drilled hole diameter < 0.35 mm [0.0138 in] and having an aspect ratio > 3.5:1, the minimum thin area copper plating in the hole **shall** be 25 µm [0.00098 in].

<sup>4</sup> Low Aspect Ratio Blind Vias refer to blind vias produced using a controlled depth mechanism (e.g., laser, mechanical, plasma or photo defined). All performance characteristics for plated holes, as defined in this document, **shall** be met.

storage, pre-assembly baking and sequential soldering processes impact solderability. Specific solderability retention requirement, if applicable, **shall** be specified in the procurement documentation.

**3.2.8 Polymer Coating (Solder Resist)** When permanent solder resist coating is specified, it **shall** be a polymer coating conforming to IPC-SM-840. (See requirements section on solder resist, 3.8.)

**3.2.9 Fusing Fluids and Fluxes** The composition of the fusing fluids and fluxes used in solder coating applications **shall** be capable of cleaning the tin-lead plating and bare copper to allow for a smooth adherent coating. The fusing fluid **shall** act as a heat transfer and distribution media to prevent damage to the bare laminate of the board.

Note: Fusing fluid compatibility should be confirmed with end users' cleanliness requirements due to the diverse interactions experienced at assembly soldering.

**3.2.10 Marking Inks** Marking inks **shall** be permanent, nonnutrient polymer inks, and **shall** be specified in the procurement documentation. Marking inks **shall** be applied

to the board, or to a label applied to the board. Marking inks and labels must be capable of withstanding fluxes, cleaning solvents, soldering, cleaning and coating processes encountered in later manufacturing processes. If a conductive marking ink is used, the marking **shall** be treated as a conductive element on the board.

**3.2.11 Hole Fill Insulation Material** Electrical insulation material used for hole-fill for metal core printed boards **shall** be as specified in the procurement documentation.

**3.2.12 Heatsink Planes, External** Thickness and materials for construction of heatsink planes and insulation material **shall** be as specified in the procurement documentation.

**3.3 Visual Examination** Finished printed boards **shall** be examined in accordance with the following test method. They **shall** be of uniform quality and **shall** conform to 3.3.1 through 3.3.9.

Visual examination for applicable attributes **shall** be conducted at 1.75X (approx. 3 diopters); if the condition of a suspected defect is not apparent, it should be verified at

progressively higher magnifications (up to 40X) to confirm that it is a defect. Dimensional requirements such as spacing or conductor width measurements require other magnifications and devices with reticles or scales in the instrument that allow accurate measurements of the specified dimensions. Other magnifications may be required by contract or specification.

**3.3.1 Edges** Nicks or haloing along the edge of the board, edge of cutouts and edges of nonplated-through holes are acceptable provided the penetration does not exceed 50% of the distance from the edge to the nearest conductor or 2.5 mm [0.0984 in], whichever is less. Edges **shall** be clean cut and without metallic burrs. Nonmetallic burrs are acceptable as long as they are not loose and/or do not affect fit and function. Panels which are scored or routed with a breakaway tab **shall** meet the depanelization requirements of the assembled board.

**3.3.2 Laminate Imperfections** Measling, crazing, blistering, delamination, and haloing **shall** be in accordance with IPC-A-600.

**3.3.2.1 Foreign Inclusions** Foreign inclusions **shall** be in accordance with IPC-A-600 with the exception that the inclusion has no maximum dimension.

**3.3.2.2 Weave Exposure** Weave exposure or exposed/disrupted fibers are acceptable for all Classes provided the imperfection does not reduce conductor spacing below the minimum. Refer to IPC-A-600 for more information.

**3.3.2.3 Scratches, Dents, and Tool Marks** Scratches, dents, and tool marks are acceptable provided they do not bridge conductors or expose/disrupt fibers greater than allowed in the paragraphs above and do not reduce the dielectric spacing below the minimum specified.

**3.3.2.4 Surface Voids** Surface voids are acceptable provided they do not: exceed 0.8 mm [0.0031 in] in the longest dimension; bridge conductors; or exceed 5% of the total board area.

**3.3.2.5 Color Variations in Bond Enhancement Treatment** Mottled appearance or color variation in bond enhancement treatment is acceptable. Random missing areas of treatment **shall not** exceed 10% of the total conductor surface area of the affected layer.

**3.3.2.6 Pink Ring** No evidence exists that pink ring affects functionality. The presence of pink ring may be considered an indicator of process or design variation but is not a cause for rejection. The focus of concern should be the quality of the lamination bond.

**3.3.3 Plating and Coating Voids in the Hole** Plating and coating voids **shall not** exceed that allowed by Table 3-3.

**Table 3-3 Plating and Coating Voids Visual Examination**

Material	Class 1	Class 2	Class 3
Copper	Three voids allowed per hole in not more than 10% of the holes	One void allowed per hole in not more than 5% of the holes	None
Finish Coating	Five voids allowed per hole in not more than 15% of the holes	Three voids allowed per hole in not more than 5% of the holes	One void allowed per hole in not more than 5% of the holes

**Note 1:** For class 2 product, copper voids **shall not** exceed 5% of the hole length. For class 1 product, copper voids **shall not** exceed 10% of the hole length. Voids **shall not** extend beyond 90° of the circumference.

**Note 2:** For class 2 and 3 product, finished coating voids **shall not** exceed 5% of the hole length. For class 1, finished coating voids **shall not** exceed 10% of the hole length. Voids **shall not** extend beyond 90° for class 1, 2 or 3.

**3.3.4 Lifted Lands** When visually examined in accordance with 3.3, the finished board **shall not** exhibit any lifted lands.

**3.3.5 Marking** Each individual board, each qualification board, and quality conformance test circuitry (as opposed to each individual test coupon) **shall** be marked in order to insure traceability between the boards/quality conformance test circuitry and the manufacturing history and to identify the supplier (logo, etc.). The marking **shall** be produced by the same process as used in producing the conductive pattern, or by use of a permanent fungistatic ink or paint (see 3.2.11), LASER marker or by vibrating pencil marking on a metallic area provided for marking purposes or a permanently attached label. Conductive markings, either etched copper or conductive ink (see 3.2.10) **shall** be considered as electrical elements of the circuit and **shall not** reduce the electrical spacing requirements. All markings **shall** be compatible with materials and parts, legible for all tests, and in no case affect board performance. Marking **shall not** cover areas of lands that are to be soldered. Refer to IPC-A-600 for legibility requirements. In addition to this marking, the use of bar code marking is permissible. When used, date code **shall** be formatted per the suppliers discretion in order to establish traceability as to when the manufacturing operations were performed.

**3.3.6 Solderability** Only those printed boards that require soldering in a subsequent assembly operation require solderability testing. Boards that do not require soldering do not require solderability testing and this **shall** be specified on the master drawing, as in the case where press-fit components are used. Boards to be used only for surface mount do not require hole solderability testing.

When required by the procurement documentation, accelerated aging for coating durability **shall** be in accordance with J-STD-003. The Category of durability **shall** be specified on the master drawing; however, if not specified, Category 2 **shall** be used. Test coupons or production boards to be tested **shall** be conditioned, if required, and evaluated for surface and hole solderability using J-STD-003.

When solderability testing is required, consideration should be given to board thickness and copper thickness. As both increase, the amount of time to properly wet the sides of the holes and the tops of the lands increases proportionately.

**Note:** Accelerated aging (steam aging) is intended for use on coatings of tin/lead, tin/lead solder or tin, but not other final finishes.

**3.3.7 Plating Adhesion** Printed boards **shall** be tested in accordance with the following procedure. The adhesion of the plating **shall** be tested in accordance with IPC-TM-650, Method 2.4.1, using a strip of pressure sensitive tape applied to the surface and removed by manual force applied perpendicular to the circuit pattern.

There **shall** be no evidence of any portion of the protective plating or the conductor pattern foil being removed, as shown by particles of the plating or pattern foil adhering to the tape. If overhanging metal (slivers) breaks off and adheres to the tape, it is evidence of overhang or slivers, but not of plating adhesion failure.

**3.3.8 Edge Board Contact, Junction of Gold Plate to Solder Finish** Exposed copper/plating overlap between the solder finish and gold plate **shall** meet the requirements of Table 3-4. The exposed copper/plating or gold overlap may exhibit a discolored or gray-black area which is acceptable. (See 3.5.4.3).

**Table 3-4 Edge Board Contact Gap**

	<b>Max. Exposed Copper Gap</b>	<b>Max. Gold Overlap</b>
Class 1	2.5 mm [0.0984 in]	2.5 mm [0.0984 in]
Class 2	1.25 mm [0.04921 in]	1.25 mm [0.04291 in]
Class 3	1.0 mm [0.031 in]	1.0 mm [0.031 in]

**3.3.9 Workmanship** Printed boards **shall** be processed in such a manner as to be uniform in quality and show no visual evidence of dirt, foreign matter, oil, fingerprints, tin/lead or solder smear transfer to the dielectric surface, flux residue and other contaminants that affect life, ability to assemble and serviceability. Visually dark appearances in nonplated holes, which are seen when a metallic or nonmetallic semiconductive coating is used, are not foreign material and do not affect life or function. Printed boards **shall** be free of defects in excess of those allowed in this speci-

fication. There **shall** be no evidence of any lifting or separation of platings from the surface of the conductive pattern, or of the conductor from the base laminate in excess of that allowed. There **shall** be no loose plating slivers on the surface of the printed board.

**3.4 Board Dimensional Requirements** The board **shall** meet the dimensional requirements specified in the procurement documents. All dimensional characteristics such as board periphery, thickness, cutouts, slots, notches, and edge board contacts to connector key area **shall** be as specified in the procurement documentation.

Automated inspection technology is allowed (see IPC-AI-642).

**3.4.1 Hole Size and Hole Pattern Accuracy** The hole size tolerance and hole pattern accuracy **shall** be as specified in the procurement documentation. Nodules or rough plating in plated-through holes **shall not** reduce the hole diameter below the minimum limits defined in the procurement document.

**3.4.2 Annular Ring and Breakout (Internal)** The F coupon may be used to assess annular ring and breakout of internal lands by external visual inspection or radiographic (x-ray) techniques. If internal annular ring breakout is detected but the degree of breakout can not be determined, it **shall** be measured by horizontal microsection. The test coupon or production board used for the horizontal microsection **shall** be taken from the affected area and analyzed on the suspect layer(s). Requirements are shown in Table 3-5. Measurement for annular ring is from the inside of the drilled hole to the edge of the internal land as shown in Figure 3-1. Negative etchback is evaluated per 3.6.2.7. Buried vias are considered to be an external layer and are evaluated in process before multilayer lamination.

Internal registration may be assessed by nondestructive techniques such as patterns, probes and software which are configured to provide information on annular ring remaining and pattern skew. Prior to acceptance of the technique, microsectioning **shall** be used to verify correlation, and a calibration standard made for the probe technique which **shall** be used to periodically verify acceptability.

**3.4.3 Annular Ring (External)** The minimum external annular ring **shall** meet the requirements of Table 3-5. The measurement of the annular ring on external layers is from the inside surface (within the hole) of the plated hole, or unsupported hole, to the outer edge of the annular ring on the surface of the board. Plated-through holes identified as vias can have up to 90° breakout of the annular ring if it does not occur at the conductor and land intersection. (See Figure 3-2A and 3-2B).

**Table 3-5 Minimum Internal and External Annular Ring**

Characteristic	Class 1	Class 2	Class 3
Plated-through holes (see Figure 3-2A and 3-2B for land breakout and conductor width reduction at land)	180° breakout of hole from land is allowed when visually assessed <sup>1</sup> . For the external lands, the land/conductor junction is not reduced more than 30% of the minimum conductor width specified on the master drawing or the production master nominal.	90° breakout of hole from land is allowed when visually assessed <sup>1</sup> . For the external lands, the land/conductor junction <b>shall not</b> be reduced below the allowable width reduction in 3.5.3.1. The conductor junction should never be less than 50 μm [0.0020 in] or the minimum line width, whichever is smaller.	The minimum external annular ring <b>shall not</b> be less than 50 μm [0.0020 in]. The minimum functional internal annular ring <b>shall not</b> be less than 25 μm [0.00098 in]. The minimum external annular ring may have 20% reduction of the minimum annular ring in isolated areas due to defects such as pits, dents, nicks, pinholes, or splay in the annular ring of isolated areas.
Unsupported holes	No breakout at conductor junction.	No breakout allowed.	The minimum annular ring <b>shall not</b> be less than 150 μm [0.00591 in]. The minimum external annular ring may have a 20% reduction of the minimum annular ring in isolated areas due to defects such as pits, dents, nicks, pinholes or splay in the annular ring of isolated areas.

<sup>1</sup>Minimum lateral spacing **shall** be maintained.

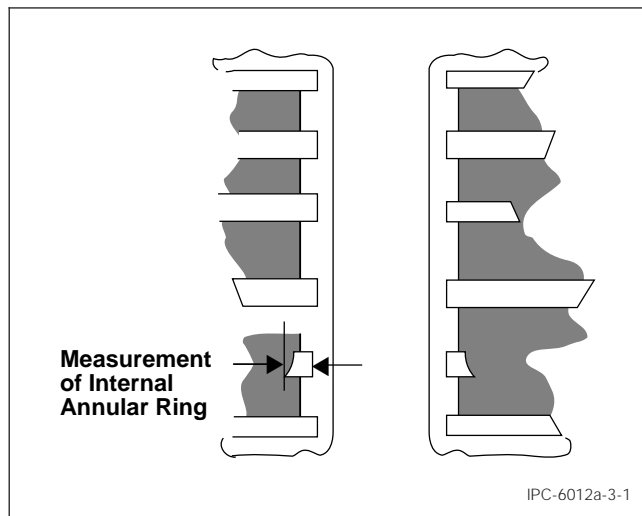

**Figure 3-1 Annular Ring Measurement**

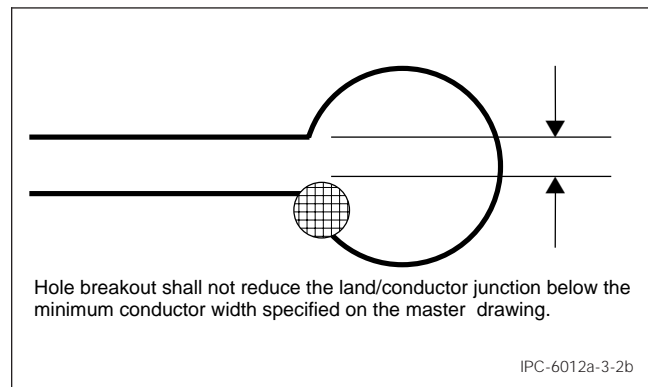

**Figure 3-2B Conductor Width Reduction**

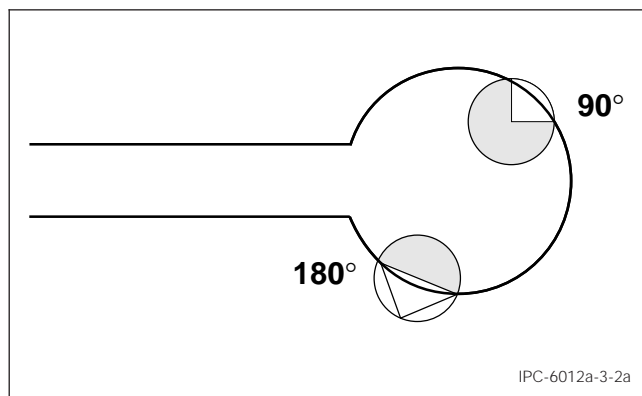

**Figure 3-2A Breakout of 90° and 180°**

**3.4.4 Bow and Twist** Unless otherwise specified in the procurement documentation, when designed in accordance with 5.2.4 of IPC-2221, the printed board **shall** have a maximum bow and twist of 0.75% for boards that use surface mount components and 1.5% for all other boards. Panels which contain multiple printed boards which are assembled on the panel and later separated **shall** be assessed in panel form.

Bow, twist, or any combination thereof, **shall** be determined by physical measurement and percentage calculation in accordance with IPC-TM-650, Method 2.4.22.

**3.5 Conductor Definition** All conductive areas on printed boards including conductors, lands and planes **shall** meet the visual and dimensional requirements of the following sections. The conductor pattern **shall** be as specified in the procurement documentation. Verification of dimensional attributes **shall** be performed in accordance with 3.3 and IPC-A-600. AOI inspection methods are allowed (see



**Table 3-6 Plated-Through Hole Integrity After Stress**

Property	Class 1	Class 2	Class 3
Copper voids	Three voids allowed per hole. Voids in the same plane are not allowed. No void <b>shall</b> be longer than 5% of board thickness. No circumferential voids allowed.	One void allowed per specimen provided the additional microsection criteria of 3.6.2.2 are met.	One void allowed per specimen provided the additional microsection criteria of 3.6.2.2 are met.
Plating folds/inclusions <sup>2</sup>	Must be enclosed	Must be enclosed	Must be enclosed
Burrs <sup>2</sup> and nodules <sup>2</sup>	Allowed if minimum hole diameter is met	Allowed if minimum hole diameter met	Allowed if minimum hole diameter met
Glass fiber protrusion	Allowed. See 3.6.2.10	Allowed. See 3.6.2.10	Allowed. See 3.6.2.10
Wicking	125 µm [0.00492 in] maximum	100 µm [0.00393 in] maximum	80 µm [0.00315 in] maximum
Innerlayer inclusions (inclusions at the interface between internal lands and through-hole plating)	Allowed on only one side of hole wall at each land location on 20% of available lands	None allowed	None allowed
Internal foil cracks <sup>1</sup>	“C” cracks allowed on only one side of hole provided it does not extend through foil thickness	None allowed	None allowed
External foil cracks <sup>1</sup> (type “A,” “B” and “D” cracks)	“D” cracks not allowed. “A” and “B” cracks allowed.	“D” and “B” cracks not allowed. “A” cracks allowed.	“D” and “B” cracks not allowed. “A” cracks allowed.
Barrel/Corner cracks <sup>1</sup> (type “E” and “F” cracks)	None allowed	None allowed	None allowed
Innerlayer separation (separation at the interface between internal lands and through-hole plating)	Allowed on only one side of hole wall at each land location on 20% of available lands	None allowed	None allowed
Separations along the vertical edge of the external land(s)	Allowed (see Figure 3-3) provided it does not extend beyond the vertical edge of the external copper foil		
Plating separation	Allowed at knee, maximum length 130 µm [0.00512 in]	None allowed	None allowed
Hole wall dielectric/ plated barrel separation	Acceptable provided dimensional and plating requirements are met	Acceptable provided dimensional and plating requirements are met	Acceptable provided dimensional and plating requirements are met
Lifted lands after thermal stress or rework simulation	Allowed provided the finished boards meet the visual criteria of 3.3.4		

<sup>1</sup>Copper crack definition: See Figure 3-4

- “A” crack = A crack in the external foil
- “B” crack = A crack that does not completely break plating (minimum plating remains)
- “C” crack = A crack in the internal foil
- “D” crack = A crack in the external foil and plating - complete break in foil and plating
- “E” crack = A barrel crack in plating only
- “F” crack = A corner crack in the plating only

<sup>2</sup>The minimum copper thickness in Table 3-2 must be met.

IPC-AI-642). Internal conductors are examined during internal layer processing prior to multilayer lamination.

**3.5.1 Conductor Width and Thickness** When not specified on the master drawing the minimum conductor width **shall** be 80% of the conductor pattern supplied in the procurement documentation. When not specified on the master drawing, the minimum conductor thickness **shall** be in accordance with 3.6.2.11 and 3.6.2.12.

**3.5.2 Conductor Spacing** The conductor spacing **shall** be within the tolerance specified on the master drawing. Minimum spacing between the conductor and the edge of the board **shall** be as specified on the master drawing.

If minimum spacing is not specified, the allowed reduction in the nominal conductor spacings shown in the engineering documentation due to processing **shall** be 20% for Class 3 and 30% for Class 1 and 2 (minimum product spacing requirements as previously stated apply).

**3.5.3 Conductor Imperfections** The conductive pattern **shall** contain no cracks, splits or tears. The physical geometry of a conductor is defined by its width x thickness x length. Any combination of defects specified in 3.5.3.1 and 3.5.3.2 **shall not** reduce the equivalent cross sectional area (width x thickness) of the conductor by more than 20% of the minimum value (minimum thickness x minimum width) for Class 2 and 3, and 30% of the minimum value

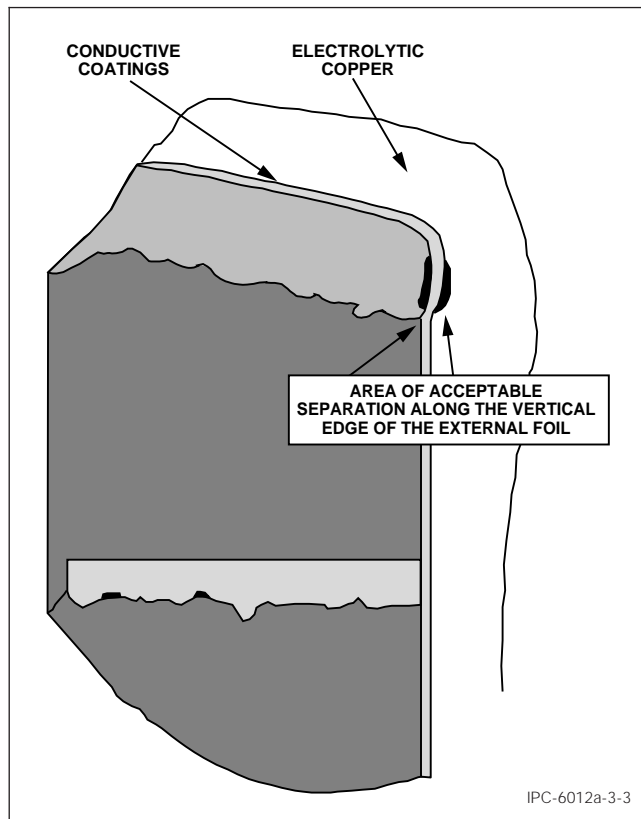

Figure 3-3 Separations at External Foil

for Class 1. The total combination of defect area lengths on a conductor **shall not** be greater than 10% of the conductor length or 25 mm [0.984 in] (for Class 1) or 13 mm [0.512 in] (for Class 2 or 3), whichever is less.

**3.5.3.1 Conductor Width Reduction** Allowable reduction of the minimum conductor width (specified or derived) due to isolated defects (i.e., edge roughness, nicks, pinholes and scratches) which exposes base material **shall not** exceed 20% of the minimum conductor width for Class 2 and 3, and 30% of the minimum conductor width for Class 1.

**3.5.3.2 Conductor Thickness Reduction** Allowable reduction of the minimum conductor thickness due to isolated defects (i.e., edge roughness, nicks, pinholes, depressions and scratches) **shall not** exceed 20% of the minimum conductor thickness for Class 2 and 3, and 30% of the minimum conductor thickness for Class 1.

**3.5.4 Conductive Surfaces**

**3.5.4.1 Nicks and Pinholes in Ground or Voltage Planes** Nicks and pinholes are acceptable in ground or voltage planes for Class 2 and 3 if they do not exceed 1.0 mm [0.0394 in] in their longest dimension and there are no more than four per side per 625 cm<sup>2</sup>. For Class 1, the longest dimension **shall** be 1.5 mm [0.0591 in] with no more than six per side, per 625 cm<sup>2</sup>.

**3.5.4.2 Surface Mount Lands** Defects such as nicks, dents, and pin holes along the edge of the land **shall not** exceed 20% of either the length or width of the land for Class 2 or Class 3 boards, or 30% for Class 1. Defects internal to the land **shall not** exceed 10% of the length or width of the land for Class 2 or Class 3 boards, or 20% for Class 1.

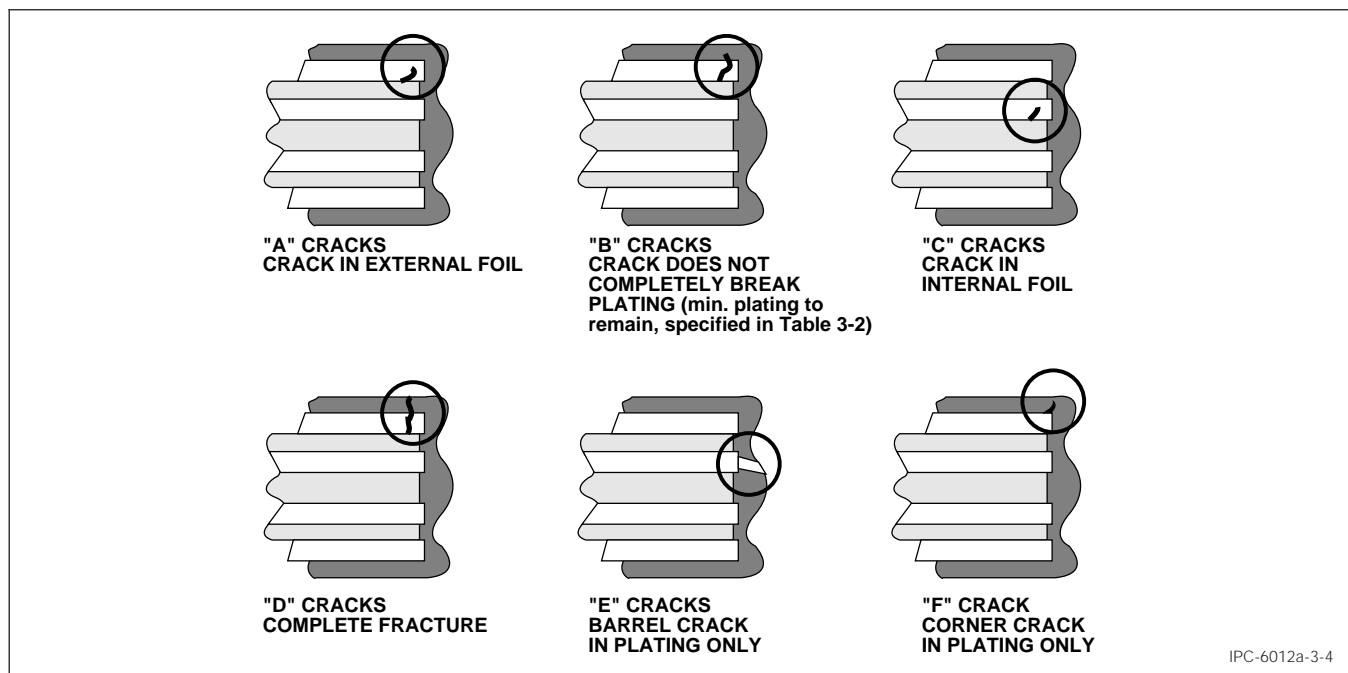

Figure 3-4 Crack Definition

**3.5.4.3 Edge Board Connector Lands** On gold or other noble metal plated edge board connector lands, except as noted below, the insertion or contact area **shall** be free of cuts or scratches that expose nickel or copper, solder splashes or tin-lead plating, and nodules or metal bumps that protrude above the surface. Pits, dents or depressions are acceptable if they do not exceed 0.15 mm [0.00591 in] in their longest dimension and there are not more than 3 per land and do not appear on more than 30% of the lands. The imperfection limits do not apply to a band 0.15 mm [0.00591 in] wide around the perimeter of the land including the insertion area.

**3.5.4.4 Dewetting** For tin, tin/lead reflowed, or solder coated surfaces, dewetting on conductors, areas of solder connection, and ground or voltage planes is allowed to the extent listed below:

- a. Conductors and planes—permitted for all classes.
- b. Individual areas of solder connection—Class 1–15%; Class 2–5%; Class 3–5%.

**3.5.4.5 Nonwetting** For tin, tin/lead reflowed or solder coated surfaces, nonwetting is not permitted on any conductive surface where a solder connection will be required.

**3.5.4.6 Final Finish Coverage** Final finish **shall** meet the solderability requirements of J-STD-003. Exposed copper on areas not to be soldered is permitted on 1% of the conductor surfaces for Class 3 and 5% of the surfaces for Class 1 and Class 2. Coverage does not apply to vertical conductor edges.

**3.6 Structural Integrity** Printed boards **shall** meet structural integrity requirements for thermally stressed (after solder float) evaluation test coupons specified in 3.6.2. Although the A and B coupons are assigned for this test, production boards may be used in lieu of the A/B coupons and are preferred for product that contains surface mount and vias or surface mount mixed with through-hole technology. Holes selected **shall** be equivalent to those specified for test coupons. The production boards and all other test coupons in the quality conformance test circuitry which contain plated-through holes **shall** be capable of meeting the requirements of this section. Structural integrity **shall** be used to evaluate test coupons or production boards from Type 2 through Type 6 boards by microsectioning techniques. Characteristics not applicable to Type 2 boards (i.e., requirements for innerlayer separations, innerlayer inclusions, and inner foil cracks) are not evaluated. Dimensional measurements that are only possible through the use of microsectioning techniques are also defined in this section. Blind and buried vias **shall** meet the requirements of plated-through holes.

The evaluation of all properties and requirements **shall** be performed on the thermally stressed test coupon and all requirements must be met; however, per supplier election,

certain properties and conditions as defined in the following paragraph(s), which are not affected by thermal stressing, may be evaluated in a test coupon(s) that has not been thermally stressed.

- a) When a supplier elects to evaluate the unstressed test coupon for the properties listed in (b), he may do so at any operation following the copper plating operation. If the board undergoes additional thermal excursions above the  $T_g$  (glass transition temperature) after copper plating, the unstressed test coupon being evaluated **shall** also be subjected to these thermal excursions.
- b) The properties which are not affected by thermal stress are: copper voids, plating folds/inclusions, burrs and nodules, glass fiber protrusion, wicking, final coating plating voids, etchback, negative etchback, plating/coating thickness, internal and surface copper layer or foil thickness.

**3.6.1 Thermal Stress Testing** Test coupons or production boards **shall** be thermally stressed in accordance with IPC-TM-650, Method 2.6.8.

Following stress, test coupons or production boards **shall** be microsectioned. Microsectioning **shall** be accomplished per IPC-TM-650, Method 2.1.1, or 2.1.1.2 on test coupons or production boards. A minimum of three holes or vias **shall** be inspected in the vertical cross section. The grinding and polishing accuracy of the microsection **shall** be such that the viewing area of each of the three holes is within 10% of the drilled diameter of the hole.

Plated-through holes **shall** be examined for foil and plating integrity at a magnification of  $100X \pm 5\%$ . Referee examinations **shall** be accomplished at a magnification of  $200X \pm 5\%$ . Each side of the hole **shall** be examined independently. Examination for laminate thickness, foil thickness, plating thickness, lay-up orientation, lamination and plating voids, and so forth, **shall** be accomplished at magnifications specified above. Plating thicknesses below  $1 \mu\text{m}$  [0.00004 in] **shall not** be measured using metallographic techniques.

**Note:** When agreed by user and supplier, alternate techniques may be used to supplement microsection evaluation.

**3.6.2 Requirements for Microsectioned Coupons or Production Boards** When examined in microsection, the test coupons or production boards **shall** meet the requirements of Table 3-6 and paragraph 3.6.2.1 through 3.6.2.16.

**3.6.2.1 Plating Integrity** Plating integrity in the plated-through holes **shall** meet the requirements detailed in Table 3-6. For Class 2 and 3 product, there **shall** be no separation of plating layers (except as noted in Table 3-6), no plating cracks, and internal interconnections **shall** exhibit no separation or contamination between plated hole wall and internal layers.

Metal core or thermal planes, when used as electrically functional circuitry, **shall** meet the above requirements when made from copper; but those made from dissimilar metals may have small spots or pits at their junction with the hole wall plating. Those areas of contamination or inclusions **shall** neither exceed 50% of each side of the interconnection, nor occur in the interface of the copper cladding on the core and the copper plating in the hole wall when viewed in the microsection evaluation.

**3.6.2.2 Plating Voids** Class 1 product **shall** meet the requirements for plating voids established in Table 3-6. For Class 2 and 3 product, there **shall** be no more than one void per test coupon or production board, and the following criteria must be met:

- a. There **shall** be no more than one plating void per test coupon or production board, regardless of length or size.
- b. There **shall** be no plating void in excess of 5 percent of the total printed wiring board thickness.
- c. There **shall** be no plating voids evident at the interface of an internal conductive layer and plated hole wall.
- d. Circumferential plating voids are not allowed.

If a void is detected during evaluation of a microsection which meets the above criteria, resample in accordance with Table 4-2 using samples from the same lot to determine if the defect is random. If the additional test coupons or production boards have no plating voids, the product which the test coupon or production boards represent are considered acceptable; however, if a plating void is present in the microsections, the product **shall** be considered non-conforming.

**3.6.2.3 Laminate Integrity** For Class 2 and 3 products, there **shall** be no laminate voids in Zone B (Figure 3-5) in excess of 80  $\mu\text{m}$  [0.00315 in]. For Class 1 products, voids allowed in Zone B (Figure 3-5) **shall not** exceed 150  $\mu\text{m}$  [0.00591 in]. Multiple voids between two adjacent plated-through holes in the same plane **shall not** have a combined length which exceeds these limits. Cracks between two uncommon conductors in either the horizontal or vertical direction **shall not** decrease the minimum dielectric spacing.

**3.6.2.4 Laminate Cracks** Laminate cracks in Zone A (Figure 3-5) are acceptable. Cracks which originate in Zone A and extend into Zone B or are entirely in Zone B **shall not** be in excess of 80  $\mu\text{m}$  [0.00315 in] for Class 2 or 3 products, and 150  $\mu\text{m}$  [0.00591 in] for Class 1 products. Multiple cracks between two adjacent plated-through holes in the same plane **shall not** have a combined length which exceeds these limits.

**3.6.2.5 Etchback** When specified on the master drawing, printed boards **shall** be etched back for the lateral removal of resin and/or glass fibers from the drilled hole walls prior to plating. The etchback **shall** be between 5  $\mu\text{m}$  [0.00020 in] and 80  $\mu\text{m}$  [0.00315 in] with a preferred depth of 13  $\mu\text{m}$  [0.00051 in]. Shadowing is permitted on one side of each land. When no etchback is specified and the board manufacturer elects to use etchback, the manufacturer **shall** be qualified to perform etchback in his qualification test coupons or boards.

**Caution:** Etchback greater than 50  $\mu\text{m}$  [0.00197 in] may cause folds or voids in the plating, which then may not meet the required copper thickness.

**3.6.2.6 Smear Removal** Smear removal is removal of resin debris which results from the formation of the hole. Smear removal **shall** be sufficient to meet the acceptability criteria for plating separation (see Table 3-6). Smear removal **shall not** be etched back greater than 25  $\mu\text{m}$  [0.00098 in]; random tears or drill gouges which produce small areas where the 25  $\mu\text{m}$  [0.00098 in] depth is exceeded **shall not** be evaluated as smear removal. Smear removal is not required of Type 1 or Type 2 boards.

**3.6.2.7 Negative Etchback** Negative etchback **shall not** exceed the requirements shown in Figure 3-6.

**3.6.2.8 Annular Ring (Internal)** Internal annular ring, if not determined by the techniques in 3.4.2, **shall** be measured by microsection to verify conformance to Table 3-5 as shown in Figure 3-1. For Class 2 boards, if internal annular ring breakout is detected in the vertical cross section, but the degree of breakout can not be determined, it **shall** be measured by horizontal microsection. The test coupon or production board used for the horizontal microsection **shall** be taken from the affected area and analyzed on the suspect layer(s). Requirements are shown in Table 3-5. Measurement **shall** be as shown in Figures 3-2A and 3-2B.

**3.6.2.9 Lifted Lands** Lifted lands are allowed on the thermally stressed microsection.

**3.6.2.10 Plating/Coating Thickness** Based on microsection examination, or on the use of suitable electronic measuring equipment, plating/coating thicknesses **shall** meet the requirements of Table 3-2, or as specified in the procurement document. Measurements in the plated-through hole **shall** be reported as an average thickness per side of the hole. Isolated thick or thin sections **shall not** be used for averaging. Isolated areas of reduced copper thickness due to glass fiber protrusions **shall** meet the minimum thickness requirements of Table 3-2 as measured from the end of the protrusion to the hole wall.

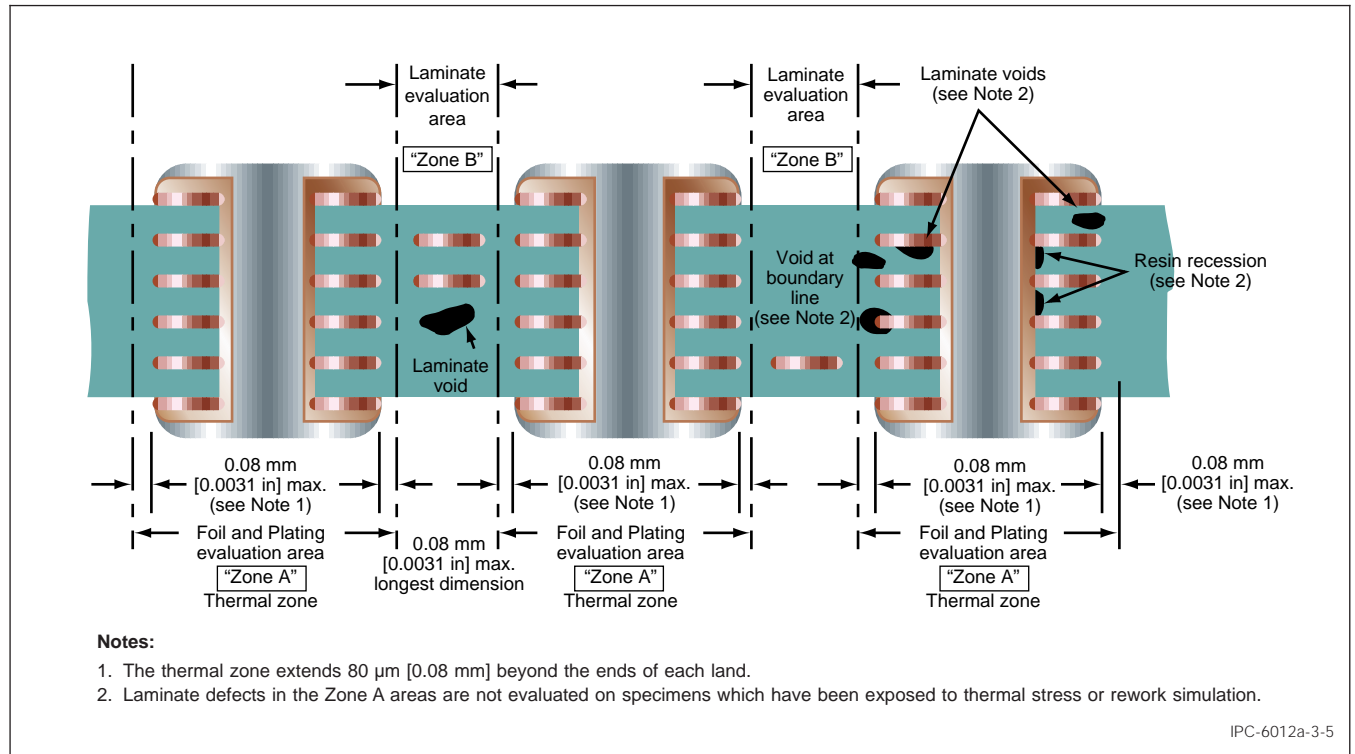

**Figure 3-5 Typical Microsection Evaluation Specimen (Three Plated-Through Holes)**

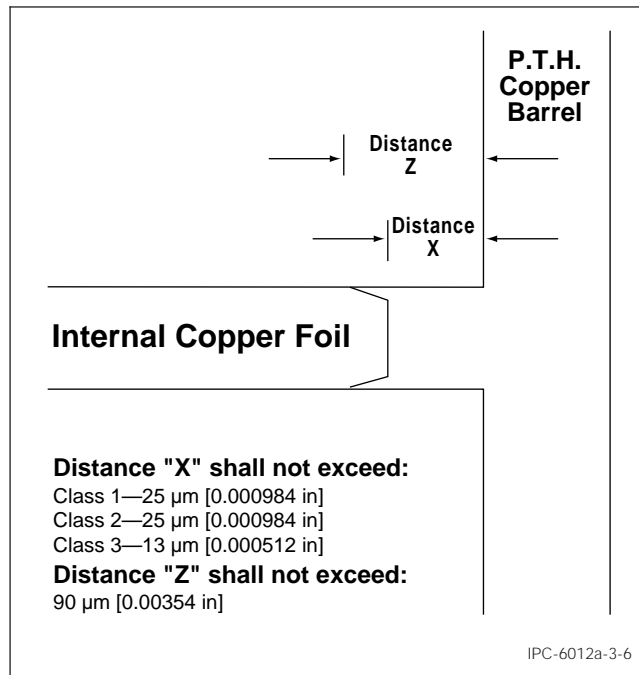

**Figure 3-6 Negative Etchback**

If copper thickness less than the minimum specified in Table 3-2 is detected in isolated areas, it should be considered a void and resample in accordance with Table 4-2 using samples from the same lot to determine if the defect is random. If the additional test coupons or production boards have no isolated areas of reduced copper thickness, the product which the test coupons or production boards represent are considered acceptable; however, if reduced

copper thickness is present in the microsections, the product **shall** be considered nonconforming.

**3.6.2.11 Minimum Internal Layer Copper Foil Thickness** If the internal conductor thickness is specified by a foil weight, the minimum internal copper thickness after processing **shall** be in accordance with Table 3-7 for all classes. When the procurement documentation specifies a minimum copper thickness for internal conductors, the conductor **shall** meet or exceed that minimum thickness.

**3.6.2.12 Minimum Surface Conductor Thickness** The minimum total (copper foil plus copper plating) conductor thickness after processing **shall** be in accordance with Table 3-8. When the procurement documentation specifies a minimum copper thickness for external conductors, the test coupon or production board **shall** meet or exceed that minimum thickness.

**3.6.2.13 Metal Cores** The minimum lateral spacing between adjacent conductive surfaces, nonfunctional lands and/or plated-through holes, and the metal plane **shall** be 100  $\mu\text{m}$  [0.00394 in] (see Figure 3-7).

**3.6.2.14 Dielectric Thickness** The minimum dielectric spacing **shall** be specified in the procurement documentation.

**Note:** Minimum dielectric spacing may be specified to be 30  $\mu\text{m}$  [0.00118 in]; however, low profile copper foils should be used and the voltages employed should be taken

**Table 3-7 Internal Layer Foil Thickness After Processing**

Copper Foil			Minimum
Designator	Weight	Starting Thickness	
E	1/8 oz	5 µm [0.00020 in]	3.5 µm [0.00014 in]
Q	1/4 oz	9 µm [0.00035 in]	6.0 µm [0.00024 in]
T	3/8 oz	12 µm [0.00047 in]	8.0 µm [0.00031 in]
H	1/2 oz	17 µm [0.00067 in]	12.0 µm [0.00047 in]
1	1 oz	35 µm [0.00138 in]	25.0 µm [0.00098 in]
2	2 oz	70 µm [0.00276 in]	56.0 µm [0.00220 in]
3	3 oz	105 µm [0.00413 in]	91.0 µm [0.00358 in]
4	4 oz	140 µm [0.00551 in]	122.0 µm [0.00480 in]
Above 4 oz			13 µm [0.00051 in] below minimum thickness listed for that foil thickness in IPC-4562

**Table 3-8 External Conductor Thickness After Plating**

Base Copper Foil			Minimum
Designator	Weight	Starting Thickness	
E	1/8 oz	5 µm [0.00020 in]	20.0 µm [0.00079 in]
Q	1/4 oz	9 µm [0.00035 in]	22.0 µm [0.00087 in]
T	3/8 oz	12 µm [0.00047 in]	25.0 µm [0.00098 in]
H	1/2 oz	17 µm [0.00067 in]	33.0 µm [0.00130 in]
1	1 oz	35 µm [0.00138 in]	46.0 µm [0.00181 in]
2	2 oz	70 µm [0.00276 in]	76.0 µm [0.00300 in]
3	3 oz	105 µm [0.00413 in]	107.0 µm [0.00421 in]
4	4 oz	140 µm [0.00551 in]	137.0 µm [0.00539 in]
For each succeeding ounce of copper foil, increase minimum conductor thickness by 30.0 µm [0.00118 in]			

into consideration so as not to cause breakdown between layers. If the minimum dielectric spacing and the number of reinforcing layers are not specified, the minimum dielectric spacing is 90 µm [0.00354 in] and the number of reinforcing layers may be selected by the supplier. When the

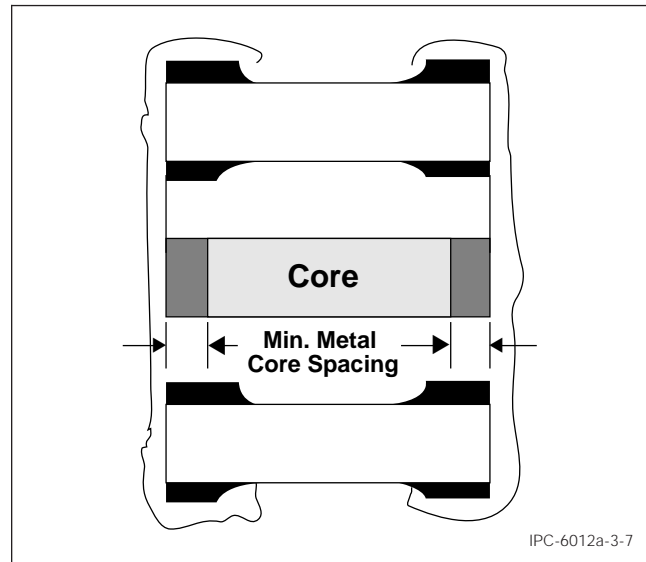
**Figure 3-7 Metal Core to Plated-Through Hole Spacing**

nominal dielectric thickness on the drawing is less than 90 µm [0.00354 in], the minimum dielectric spacing is 30 µm [0.00118 in] and the number of reinforcing layers may be selected by the supplier.

**3.6.2.15 Resin Fill of Blind and Buried Vias** There is no fill requirement for blind vias. Buried vias **shall** be at least 60% filled with the laminating resin for Class 2 and Class 3. They may be completely void of resin for Class 1.

**3.6.2.16 Nail Heading** No evidence exists that nail heading affects functionality. The presence of nail heading may be considered an indicator of process or design variation but is not a cause for rejection.

### 3.7 Other Tests

**3.7.1 Metal Core (Horizontal Microsection)** When specified, metal core printed boards which have clearance between the plated-through holes and the metal core **shall** require a horizontal microsection prepared to view the metal core/hole fill insulation. Test coupons or production boards **shall** have been subjected to thermal stress in accordance with 3.6.1 prior to microsectioning. Wicking, radial cracks, lateral spacing or voids in the hole-fill insulation material **shall not** reduce the electrical spacing between adjacent conductive surfaces to less than 100 µm [0.00394 in]. Wicking and/or radial cracks **shall not** exceed 75 µm [0.00295 in] from the plated-through hole edge into the hole-fill.

### 3.7.2 Rework Simulation

**3.7.2.1 Through Hole Components** When specified, printed boards or test coupons **shall** be tested in accordance with IPC-TM-650, Method 2.4.36 and then microsectioned and examined in accordance with 3.6. Lifted lands are allowed.

**3.7.2.2 Surface Mount Components** When specified, 100% surface mount boards **shall** be tested in accordance with the procurement documentation.

**3.7.3 Bond Strength, Unsupported Component Hole Land** The unsupported component hole lands **shall** be tested in accordance with IPC-TM-650, Method 2.4.21. The unsupported component hole land **shall** withstand 2 kg or 35 kg/cm<sup>2</sup>, whichever is less.

Calculations of land area of the unsupported hole do not include the area occupied by the hole.

**3.8 Solder Resist (Solder Mask) Requirements** When solder resist is required on printed boards, it **shall** meet the qualification/conformance requirements of IPC-SM-840. If a solder resist performance class is not specified for Class 1 or 2, IPC-SM-840 Class T **shall** be used. For Class 3 board performance, IPC-SM-840 Class H **shall** be used. The following other conformance requirements apply:

**3.8.1 Solder Resist Coverage** Solder resist coverage manufacturing variations resulting in skips, voids, and misregistration are subject to the following restrictions:

- a. Metal conductors **shall not** be exposed in areas where solder resist is required. Touch up, if required to cover these areas with solder resist, **shall** be of a material that is compatible to and of equal resistance to soldering and cleaning as the originally applied solder resist.
- b. In areas containing parallel conductors, solder resist variations **shall not** expose adjacent conductors unless the area between the conductors is purposely left blank as for a test point or for some surface mount devices.
- c. Conductors under components **shall not** be exposed or **shall** be otherwise electrically isolated. If the component pattern is not readily apparent, the area covered by a component **shall** be shown in the procurement document.
- d. Solder resist need not be flush with the surface of the land. Misregistration of a solder resist defined feature **shall not** expose adjacent isolated lands or conductors.
- e. Solder resist is allowed on lands for plated-through holes to which solder connections are to be made provided the external annular ring requirements for that Class of products are not violated; resist **shall not** encroach upon the barrel of this type of plated-through hole. Other surfaces such as edge board connector fingers and surface mount lands **shall** be free of solder resist except as specified. Solder resist is allowed in plated-through holes and via holes into which no component lead is soldered unless the procurement document requires that the holes be completely solder filled. Solder resist may tent or plug via holes and may be required for that purpose. Test points that are intended

for assembly testing must be free of solder resist unless coverage is specified.

- f. When a land contains no plated-through holes, as in the case of surface mount or ball grid array lands, misregistration **shall not** cause encroachment of the solder resist on the land or lack of solder-resist-definition in excess of the following:
  - 1) on surface mount lands misregistration **shall not** cause encroachment of the solder resist over the land area greater than 50 µm [0.00197 in] for a pitch of 1.25 mm [0.04921] or greater; and encroachment **shall not** exceed 25 µm [0.00098 in] for a pitch less than 1.25 mm [0.04921 in]; encroachment may occur on adjacent sides but not on opposite sides of a surface mount land.
  - 2) on ball grid array lands, if the land is solder-resist-defined, misregistration may allow a 90° breakout of the solder resist on the land; if clearance is specified, no encroachment of the solder resist on the land is allowed except at the conductor attachment.
- g. Pits and voids are allowed in nonconductor areas provided they have adherent edges and do not exhibit lifting or blistering in excess of allowance in 3.8.2.
- h. Coverage between closely spaced surface mount lands **shall** be as required by procurement documentation.
- i. When design requires coverage to the board edge, chipping or lifting of solder resist along the board edge after fabrication **shall not** penetrate more than 1.25 mm [0.04921 in] or 50% of the distance to the closest conductor, whichever is less.

**3.8.2 Solder Resist Cure and Adhesion** The cured solder resist coating **shall not** exhibit tackiness, delamination, or blistering to the following extent:

- Class 1 does not bridge between conductors.
- Class 2 and 3 two per side, maximum size 0.25 mm [0.00984 in] in longest dimension, does not reduce electrical spacing between conductors by more than 25%.

Rework and touch up, if required to cover these areas with solder resist, **shall** be of a material that is compatible to and of equal resistance to soldering and cleaning as the originally applied solder resist. When tested in accordance with IPC-TM-650, Method 2.4.28.1, the maximum percentage of cured solder resist lifting from the G coupon **shall** be in accordance with Table 3-9.

**3.8.3 Solder Resist Thickness** Solder resist thickness is not measured unless specified in the procurement documents. If a thickness measurement is required, instrumental methods may be used or assessment may be made using a microsection of the parallel conductors on the E coupon.

**Table 3-9 Solder Resist Adhesion**

Surface	Maximum percentage loss allowed		
	Class 1	Class 2	Class 3
Bare Copper	10	5	0
Gold or Nickel	25	10	5
Base Laminate	10	5	0
Melting Metals (Tin-lead plating, fused tin-lead, and bright acid-tin)	50	25	10

**3.9 Electrical Requirements** When tested as specified in Table 4-4, the printed boards **shall** meet the electrical requirements detailed in the following paragraphs.

**3.9.1 Dielectric Withstanding Voltage** Applicable test coupons or production boards **shall** meet the requirements of Table 3-10, without flashover, or breakdown between conductors, or conductors and lands. The dielectric withstanding voltage test **shall** be performed in accordance with IPC-TM-650, Method 2.5.7. The dielectric withstanding voltage **shall** be applied between all common portions of each conductor pattern and adjacent common portions of each conductor pattern. The voltage **shall** be applied between conductor patterns of each layer and the electrically isolated pattern of each adjacent layer.

**Table 3-10 Dielectric Withstanding Voltages**

	Class 1	Class 2 and 3
Voltage For spacing 80 $\mu\text{m}$ [0.00315 in] or greater	No requirement	500 Vdc +15, -0
Voltage For spacing less than 80 $\mu\text{m}$ [0.00315 in]	No requirement	250 Vdc +15, -0
Time	No requirement	30 sec +3, -0

**3.9.2 Electrical Continuity and Insulation Resistance** Boards **shall** be tested in accordance with IPC-ET-652.

**3.9.2.1 Continuity** Printed boards and qualification test boards **shall** be tested in accordance with the procedure outlined below. There **shall** be no circuits whose resistance exceeds the values established in IPC-ET-652. Specialized circuitry consisting of long runs of very narrow conductors, or short runs of very large conductors may increase or decrease these values. The acceptability criteria for these specialized conductors must be specified in the procurement documentation.

A current **shall** be passed through each conductor or group of interconnected conductors by applying electrodes on the terminals at each end of the conductor or group of conductors. The current passed through the conductors **shall not** exceed that specified in IPC-2221 for the smallest conductor in the circuit. For qualification, the test current **shall not** exceed one ampere. Boards with designed resistive pat-

terns **shall** meet the resistance requirements specified on the master drawing.

**3.9.2.2 Insulation Resistance** Printed Boards or qualification test boards **shall** be tested in accordance with the following procedure. The insulation resistance between conductors **shall** meet the values established in IPC-ET-652.

The voltage applied between networks must be high enough to provide sufficient current resolution for the measurement. At the same time, it must be low enough to prevent arc-over between adjacent networks, which could induce defects within the product. For manual testing, the voltage **shall** be 200 volts minimum and **shall** be applied for a minimum of five seconds. When automated test equipment is used, the minimum applied test voltage **shall** be twice the maximum rated voltage of the board. If the maximum is not specified, the test voltage **shall** be 40 volts minimum.

**3.9.3 Circuit/Plated-Through Shorts to Metal Substrate** Printed boards **shall** be tested in accordance with 3.9.1 except that polarizing voltage of 500 volts (DC) **shall** be applied between conductors and/or lands and the metallic heatsink in a manner such that each conductor/land area is tested (e.g., using a metallic brush or aluminum foil).

The board **shall** be capable of withstanding 500 volts (DC) between circuitry/plated-through holes and the metal core substrates. There **shall** be no flashover or dielectric breakdown.

**3.9.4 Moisture and Insulation Resistance (MIR)** Test coupons **shall** be tested in accordance with the procedure outlined below. The test coupon **shall not** exhibit subsurface imperfections in excess of that allowed in 3.3.2. Insulation resistance **shall** meet the minimum requirements shown in Table 3-11 (at 500 volts DC). Noncomponent flush boards **shall** have a minimum requirement of 50 M $\Omega$  for all classes. Insulation resistance requirements in the as-received condition are detailed in special requirement section (see 3.11.9).

**Table 3-11 Insulation Resistance**

	Class 1	Class 2	Class 3
As received	Maintain electrical function	500 M $\Omega$	500 M $\Omega$
After exposure to moisture	Maintain electrical function	100 M $\Omega$	500 M $\Omega$

The moisture and insulation resistance for printed boards **shall** be performed in accordance with IPC-TM-650, Method 2.6.3. Conformal coating in accordance with IPC-CC-830 **shall** be applied to the external conductors prior to chamber exposure. Final measurements **shall** be made at



room temperature within two hours after removal from the test chamber. All layers have a  $100 \pm 10$  volts DC polarizing voltage applied during chamber exposure. Mealing of the conformal coating **shall not** extend more than 3 mm [0.12 in] from the edge of the test coupon or production board.

**3.9.4.1 Dielectric Withstanding Voltage After MIR** A dielectric withstanding voltage test **shall** be performed after moisture and insulation resistance in accordance with 3.9.1.

**3.10 Cleanliness** Printed boards **shall** be tested in accordance with IPC-TM-650, Method 2.3.25 paragraph 4.0 Resistance of Solvent Extract Method. Equivalent methods may be used in lieu of the method specified; however it **shall** be demonstrated to have equal or better sensitivity and employ solvents with the ability to dissolve flux residue or other contaminants as does the solution presently specified.

**3.10.1 Cleanliness Prior to Solder Resist Application** When a printed board requires a permanent solder resist coating, the uncoated boards **shall** be within the allowable limits of ionic and other contaminants prior to the application of solder resist coating.

When noncoated printed boards are tested per 3.10, the contamination level **shall not** be greater than an equivalent of  $1.56 \mu\text{g}/\text{cm}^2$  of sodium chloride.

**3.10.2 Cleanliness After Solder Resist, Solder, or Alternative Surface Coating Application** When specified, printed boards **shall** be tested per 3.10 and meet the requirements in the procurement documentation.

**3.10.3 Cleanliness of Inner Layers After Oxide Treatment Prior to Lamination** When specified, inner layers **shall** be tested per 3.10 and meet the requirements of the procurement documentation.

**3.11 Special Requirements** When specified in the procurement documentation, some or all of the special requirements listed in this section (3.11) **shall** apply. A notation in the procurement documentation will designate which are required.

**3.11.1 Outgassing** Printed boards **shall** be tested in accordance with the procedure outlined below. The degree of outgassing **shall not** result in a total mass loss of more than 0.1%.

Mass loss **shall** be determined on test coupons or production boards of representative substrates when tested per IPC-TM-650, Method 2.6.4. Test substrates **shall** be approximately  $1 \text{ cm}^3$  in volume. The substrates **shall** be placed in a vacuum chamber capable of achieving  $7 \times 10^{-3}$  Pa [ $5 \times 10^{-5}$  mm Hg or torr] for 24 hours.

**3.11.2 Organic Contamination** Noncoated printed boards **shall** be tested in accordance with the procedure outlined below. Any positive identification of organic contamination **shall** constitute a failure.

The printed board **shall** be tested in accordance with IPC-TM-650, Methods 2.3.38 or 2.3.39. The first is a qualitative method in which very pure acetonitrile is dripped across the test coupon or production board and collected on a microscope slide. It is dried and compared with a slide having dried, uncontaminated acetonitrile on it for visual evidence of organic residue. If evidence of organic contamination is detected by this test, Method 2.3.39 is used to determine the nature of the contaminant by the use of infrared spectrophotometric analysis using the Multiple Internal Reflectance (MIR) method.

**3.11.3 Fungus Resistance** Completed boards or representative board sections from the lot **shall not** support fungus growth when tested as follows: The specimen(s) **shall** be tested in accordance with IPC-TM-650, Method 2.6.1.

**3.11.4 Vibration** The test coupon or production board **shall** pass the circuitry test in 3.9.2 following the vibration test procedure below and **shall not** exhibit bow or twist in excess of that allowed in 3.4.4 following testing.

The boards **shall** be subjected to both a cycling and resonance dwell test with the flat surface of the board mounted perpendicular to the axis of vibration in accordance with IPC-TM-650, Method 2.6.9.

*Cycling test*—The cycling test **shall** consist of one sweep from 20 to 2000 Hz performed in 16 minutes. Input acceleration over the 20 to 2000 Hz frequency range **shall** be maintained to 15 Gs.

*Resonance dwell*—Test coupons or production boards **shall** be subjected to a 30 minute resonance dwell with 25 Gs input or a maximum of 100 Gs output measured at the geometric center of the test coupon or production board. The test coupons or production boards **shall** be restrained from movement by fixturing on all four sides.

**3.11.5 Mechanical Shock** The test boards **shall** pass the circuitry test in 3.9.2 after being subjected to mechanical shock testing as follows.

The mechanical shock test **shall** be performed in accordance with IPC-TM-650, Method 2.6.5. The boards **shall** be subjected three times to a shock pulse of 100 Gs with a duration of 6.5 milliseconds in each of the three principal planes. The test coupons or production boards **shall** be restrained from movement by fixturing on all four edges.

**3.11.6 Impedance Testing** Requirements for impedance **shall** be specified on the master drawing. Impedance testing may be performed on a test coupon or a designated circuit in the production board. Time Domain Reflectometers

(TDR) are used for electrical testing, but for large impedance tolerances, mechanical measurements from a micro-section utilizing a special test coupon can be used to calculate and verify impedance values. (See IPC-2221 for the equations for calculating impedance from the test coupon and IPC-TM-650, Method 2.5.5.7 for the test method using the TDR technique.)

**3.11.7 Coefficient of Thermal Expansion (CTE)** When boards that have metal cores or reinforcements with a requirement to constrain the thermal expansion in the planar directions, the Coefficient of Thermal Expansion **shall** be within  $\pm 2$  ppm/ $^{\circ}$ C for the CTE and temperature range specified on the procurement documentation. Testing **shall** be by the strain gauge method in accordance with IPC-TM-650, Method 2.4.41.2. If agreed upon by user and supplier, other methods of determining the CTE may be used.

**3.11.8 Thermal Shock** When specified, printed boards or test coupons **shall** be tested in accordance with IPC-TM-650, Method 2.6.7.2. An increase in resistance of 10% or more **shall** be considered a reject. After microsectioning, the boards or test coupons **shall** meet the requirements of Table 3-6 and Figure 3-4.

For polytetrafluoroethylene (PTFE) material types, the board or test coupon **shall** meet the circuitry requirements of 3.9.2 at room temperature after the 100th cycle and no microsectioning is required.

**3.11.9 Surface Insulation Resistance (As Received)** Test coupons **shall** be tested in accordance with the procedure outlined below. The insulation resistance **shall** be no less than that shown in Table 3-11.

Test coupons or production boards should be conditioned at  $50 \pm 5^{\circ}$ C [ $122 \pm 9^{\circ}$ F] with no added humidity for a period of 24 hours. After cooling, the insulation resistance test **shall** be performed in accordance with the ambient temperature measurements specified in IPC-TM-650, Method 2.6.3.

**3.12 Repair** Repair of bare boards **shall** be as agreed upon between the user and supplier for each set of procurement documentation. (See IPC-7721.)

**3.12.1 Circuit Repairs** When agreed on between user and supplier, circuit repairs on Classes 1, 2, and 3 will be permitted. As a guideline, there should be no more than two circuit repairs for each  $0.09 \text{ m}^2$  or less of layer area per side. Circuit repairs on any impedance controlled circuits **shall not** violate the impedance requirement and **shall** have the agreement of the user. Circuit repairs **shall not** violate the minimum electrical spacing requirements.

**3.13 Rework** Rework is permitted for all Classes. The touch-up of surface imperfections in the base material or

removal of residual plating materials or extraneous copper will be permitted for all products when such action does not affect the functional integrity of the board.

## 4 QUALITY ASSURANCE PROVISIONS

**4.1 General** General Quality Assurance Provisions are specified in IPC-6011 and each sectional specification. The requirements specific to Rigid Boards are contained in this specification and include the Qualification Testing, Acceptance Testing and Frequency Quality Conformance Testing.

**4.1.1 Qualification** Qualification is agreed upon by the user and supplier (see IPC-6011). The qualification should consist of preproduction samples, production sample or test coupons (see IPC-6011) that are produced by the same equipment and procedures planned for the production boards. Qualification as agreed by the user may consist of documentation that supplier has furnished similar product to other users or to other similar specifications.

**4.1.2 Sample Test Coupons** Sample test coupons may be used for qualification or for on-going process control. Master drawings, databases, or phototools are available from IPC. For each type (see 1.3.2) the master drawing and phototool is listed as follows:

Type 1 Use surface layers of IPC-A-47

Type 2 Use surface layers of IPC-A-47

Type 3 Master Drawing IPC-100103,  
Phototool IPC-A-47

**Note:** IPC-100002 is the universal drilling and profile master drawing.

Table 4-1 specifies the test coupons on the sample used for qualification and process capability evaluations.

**4.2 Acceptance Tests** Use the C=0 Sampling Plan specified in Table 4-2 when "Sample" is indicated in Table 4-3. Acceptance testing **shall** be performed as specified in Table 4-3 to the requirements of this specification and IPC-6011 using either test coupons and/or production boards. The test coupons are described in IPC-2221 and indicate purpose of coupon and its frequency on a manufacturing panel.

**4.2.1 C=0 Sampling Plan** The C=0 Sampling Plan provides greater or equal protection for the Lot Tolerance Percent Defective (L.T.P.D.) protection at the 0.10 "consumer risk" level. The Index Values at the top of each sample size column associates to the A.Q.L. level. For a lot to be accepted, all samples (shown in Table 4-2) **shall** conform to the requirements. Disposition of rejected lots **shall** be fully documented. Contact the American Society for Quality Control for more information on sampling plans (H0862).

**Table 4-1 Qualification Test Coupons**

Test	Type 1	Types 2,3,5	Types 4,6	Board
Visual (5)	All	All	All	X
Solderability Surface (5) Hole (5)	M2,M5	S1,S6	S1,S6	
Dimensional (5)	All	All	All	X
Physical Plating Adhesion (5) Bond Strength	N1,N4,N5 A2,A3,A6	N1,N4,N5 A2,A3,A6	N1,N4,N5 A1,A3,A6	
Construction Integrity PTH Prior to Stress Additional Dimensions		A1,A4,A5 A1,A4,A5	Design Req. Design Req.	
PTH After Stress Thermal Stress Horizontal micro (Metal Core) Rework Simulation		B1,B4,B5 A1,B4,B5 B2,B3,B6	Design Req. A1,B4,B5 Design Req.	
Electrical Requirements DWV Continuity Insulation Resistance	E1,E4,E5 D1,D4,D5 E2,E3,E6	E1,E4,E5 D1,D4,D5 E2,E3,E6	E1,E4,E5 Design Req. E2,E3,E6	
Environmental Thermal Shock Cleanliness (5)	D2,D3,D6	D2,D3,D6	Design Req.	X
Special Requirements (6) Outgassing Organic Contamination Fungus Vibration Mechanical Shock Impedance Thermal Expansion		H1,H2,H3		X X X X

Note 5 - Not technology dependent.

Note 6 - Additional test coupons required, to be agreed upon between user and manufacturer.

**Table 4-2 C=0 Sampling Plan (Sample Size for Specific Index Value\*)**

Lot Size	Class 1			Class 2			Class 3			
	2.5*	4.0*	6.5*	1.5*	2.5*	4.0*	0.10*	1.0*	2.5*	4.0*
1-8	5	3	2	**	5	3	**	**	5	3
9-15	5	3	2	8	5	3	**	13	5	3
16-25	5	3	3	8	5	3	**	13	5	3
26-50	5	5	5	8	5	5	**	13	5	5
51-90	7	6	5	8	7	6	**	13	7	6
91-150	11	7	6	12	11	7	125	13	11	7
151-280	13	10	7	19	13	10	125	20	13	10
281-500	16	11	9	21	16	11	125	29	16	11
501-1200	19	15	11	27	19	15	125	34	19	15
1201-3200	23	18	13	35	23	18	125	42	23	18
3201-10,000	29	22	15	38	29	22	192	50	29	22
10,001-35,000	35	29	15	46	35	29	294	60	35	29

\*Index Value is associated to the A.Q.L. value. If a particular product is determined to be "critical" by the user and a smaller index value is required, the user shall designate the requirement in the procurement document and should state the "critical" requirement on the master drawing.

\*\*Denotes inspect entire lot.

**Table 4-3 Acceptance Testing and Frequency**

Inspection	Requirement and Method Section	Sample		Test Frequency			
		Production Board	Test Coupon by Board	Class 1 <sup>1</sup>	Class 2 <sup>1</sup>	Class 3 <sup>1</sup>	
Material	3.2.1-3.2.12			Manufacturer's Certification			Verifiable certificate of compliance or SPC program
Visual							
Edges of board	3.3.1	X		Sample (4.0)	Sample (2.5)	Sample (2.5)	Per board
Laminate imperfections	3.3.2	X		Sample (4.0)	Sample (2.5)	Sample (2.5)	Per board
Voids in plated hole	3.3.3	X		Sample (4.0)	Sample (2.5)	Sample (1.0)	Per panel
Lifted lands	3.3.4	X		Sample (6.5)	Sample (4.0)	Sample (4.0)	Per board
Marking and traceability	3.3.5	X	Coupons and board	Sample (6.5)	Sample (4.0)	Sample (4.0)	Per board
Workmanship	3.3.9	X		Sample (6.5)	Sample (4.0)	Sample (4.0)	Per board
Solderability							
Surface/Hole	3.3.6		C and A	Sample (4.0)	Sample (2.5)	Sample (2.5)	Per panel
Dimensional							
Board dimensional	3.4	X		Sample (6.5)	Sample (4.0)	Sample (4.0)	Per board
Hole pattern accuracy	3.4.1	X		Sample (6.5)	Sample (4.0)	Sample (4.0)	Minimum 10 evaluations per board
Annular ring and breakout (internal)	3.4.2		F	Not required	Sample (1.5) Type 3-6 only	Sample (1.0) Type 3-6 only	Per panel (4 coupons)
Annular ring (external)	3.4.3	X		Sample (6.5)	Sample (4.0)	Sample (4.0)	Per panel
Bow & twist	3.4.4	X		Sample (6.5)	Sample (4.0)	Sample (4.0)	Per board
Solder resist coverage	3.8-3.8.1	X		Sample (6.5)	Sample (4.0)	Sample (4.0)	Per board
Plating/coating thickness (electronic)	3.6.2.10	X	C	Sample (6.5)	Sample (4.0)	Sample (2.5)	Per panel
Conductor Width							
Internal	3.5.1	X		Sample (4.0)	Sample (2.5)	Sample (2.5)	Per internal panel layer
External	3.5.1	X		Sample (4.0)	Sample (2.5)	Sample (2.5)	Per panel
Conductor Spacing							
Internal	3.5.2	X		Sample (4.0)	Sample (2.5)	Sample (2.5)	Per internal panel layer (minimum 5 per layer set)
External	3.5.2	X		Sample (4.0)	Sample (2.5)	Sample (2.5)	Per board
Conductive Surfaces (Surface Only)							
Edge board contact, junction of gold plate to solder finish	3.3.8	X		Sample (6.5)	Sample (4.0)	Sample (2.5)	Per panel

Inspection	Requirement and Method Section	Sample		Test Frequency			
		Production Board	Test Coupon by Board	Class 1 <sup>1</sup>	Class 2 <sup>1</sup>	Class 3 <sup>1</sup>	
Nicks, dents, pinholes	3.5.4.1	X		Sample (6.5)	Sample (4.0)	Sample (2.5)	Per board
Dewetting/nonwetting	3.5.4.4 3.5.4.5 3.5.4.6	X		Sample (6.5)	Sample (4.0)	Sample (2.5)	Per board
Edge board connector	3.5.4.3	X		Sample (6.5)	Sample (4.0)	Sample (2.5)	Per board
Surface mount	3.5.4.2	X		Sample (6.5)	Sample (4.0)	Sample (2.5)	Minimum 10 evaluations per panel
Physical							
Plating adhesion	3.3.7	X	C	Sample (6.5)	Sample (4.0)	Sample (4.0)	Per panel (1 coupon)
Solder resist cure & adhesion	3.8 3.8.2		G	Sample (6.5)	Sample (4.0)	Sample (4.0)	Per panel (1 coupon)
Structural Integrity After Stress Types 3-6 (Microsection)							
Plating integrity	3.6.2.1		A or B	Sample (2.5)	Sample (1.5)	Sample (0.1)	Per panel (1 coupon)
Laminate integrity	3.6.2.3		A or B	Sample (2.5)	Sample (1.5)	Sample (0.1)	Per panel (1 coupon)
Etchback/negative etchback	3.6.2.5 3.6.2.7		A or B	Sample (2.5)	Sample (1.5)	Sample (0.1)	Per panel (1 coupon)
Annular ring (internal)	3.6.2.8		A or B	Sample (2.5)	Sample (1.5)	Sample (0.1)	Per panel (1 coupon)
Lifted lands	3.6.2.9		A or B	Sample (2.5)	Sample (1.5)	Sample (0.1)	Per panel (1 coupon)
Hole plating thickness	3.6.2.10		A or B	Sample (2.5)	Sample (1.5)	Sample (0.1)	Per panel (1 coupon)
Surface plating and conductor thickness	3.6.2.10 3.6.2.12		A,B,or C	Sample (2.5)	Sample (1.5)	Sample (0.1)	Per panel (1 coupon)
Conductor thickness (internal)	3.6.2.11		A or B	Sample (2.5)	Sample (1.5)	Sample (0.1)	Per panel (1 coupon)
Metal core spacing	3.6.2.13		A or B	Sample (2.5)	Sample (1.5)	Sample (0.1)	Per panel (1 coupon)
Dielectric thickness	3.6.2.14		A or B	Sample (2.5)	Sample (1.5)	Sample (0.1)	Per panel (1 coupon)
Resin fill of blind/buried vias	3.6.2.15		A or B	Sample (6.5)	Sample (4.0)	Sample (4.0)	Per panel
Structural Integrity After Stress Type 2 (Microsection)							
Plating integrity	3.6.2.1		A or B	Sample (6.5)	Sample (4.0)	Sample (2.5)	Per panel
Laminate integrity	3.6.2.3		A or B	Sample (6.5)	Sample (4.0)	Sample (2.5)	Per panel
Lifted lands	3.6.2.9		A or B	Sample (6.5)	Sample (4.0)	Sample (2.5)	Per panel
Hole Plating thickness	3.6.2.10		A or B	Sample (6.5)	Sample (4.0)	Sample (2.5)	Per panel

Inspection	Requirement and Method Section	Sample		Test Frequency						
		Production Board	Test Coupon by Board	Class 1 <sup>1</sup>		Class 2 <sup>1</sup>		Class 3 <sup>1</sup>		
Surface plating and conductor thickness	3.6.2.10 3.6.2.12		A or B	Sample (6.5)		Sample (4.0)		Sample (2.5)		Per panel
Electrical										
Circuit continuity	3.9.2.1	X		Type 1-2 <sup>2</sup>	Type 3-6 Sample (2.5)	Type 1-2 <sup>2</sup>	Type 3-6 100%	Type 1-2 <sup>2</sup>	Type 3-6 100%	Per board
Insulation resistance	3.9.2.2	X		Type 1-2 <sup>2</sup>	Type 3-6 Sample (2.5)	Type 1-2 <sup>2</sup>	Type 3-6 100%	Type 1-2 <sup>2</sup>	Type 3-6 100%	Per board
Cleanliness										
Cleanliness prior to solder resist application	3.10.1									
Special Requirements (when specified)										
Metal core (horizontal microsection)	3.7.1	As specified by contract or master drawing								
Solder resist thickness	3.8.3									
Dielectric withstanding voltage	3.9.1									
Circuit/plated-through shorts to metal substrate	3.9.3									
Cleanliness after surface coating application	3.10.2									
Cleanliness of inner layers after oxide treatment prior to lamination	3.10.3									
Outgassing	3.11.1									
Organic contamination	3.11.2									
Fungus resistance	3.11.3									
Vibration	3.11.4									
Mechanical shock	3.11.5									
Impedance testing	3.11.6									
Coefficient of thermal expansion	3.11.7									
Thermal shock	3.11.8									

Inspection	Requirement and Method Section	Sample		Test Frequency			
		Production Board	Test Coupon by Board	Class 1 <sup>1</sup>	Class 2 <sup>1</sup>	Class 3 <sup>1</sup>	
Surface insulation resistance (as received)	3.11.9	As specified by contract or master drawing					
Repair	3.12						
Circuit repair	3.12.1						

**Note**

1. Number in parentheses is the AQL level
2. For Type 1 and 2 boards, visual or AOI inspection may be used in lieu of electrical testing.

**4.2.2 Referee Tests** Two additional microsection sets from the same panel may be prepared and evaluated for microsection defects that are considered to be isolated or random in nature or caused by microsection preparation. For acceptance, both referee sets must be defect free.

**4.3 Quality Conformance Testing** Quality Conformance Testing **shall** consist of inspections specified in Table 4-4 in a laboratory which meets all requirements of IPC-QL-653, unless otherwise specified by the user. Class 3 testing may be extended to reliability test and evaluation for Class 2.

**4.3.1 Coupon Selection** Two sets of test coupons of the most complex pattern of each type of material processed during the inspection period **shall** be selected from lots that have passed acceptance testing.

**5 NOTES**

**5.1 Ordering Data** The procurement documentation should specify the following:

- A. Title, number, issue, revision letter, and date of current applicable master drawing.
- B. Specific exceptions, variations, additions or conditions to this specification that are required by the user.
- C. Part Identification and Marking instructions.
- D. Information for preparation for delivery, if applicable.
- E. Special tests required and frequency.

**5.2 Superseded Specifications** This specification supersedes and replaces IPC-RB-276 and IPC-6012 in the performance and requirements sections.

**Table 4-4 Quality Conformance Testing**

Inspection	Requirement and Method Section	Test Coupon		Test Frequency		
		Type 1	Types 2-6	Class 1	Class 2	Class 3
Rework simulation (when specified)	3.7.2	—	A <sup>1</sup>	NA	NA	Monthly
Bond strength	3.7.3	B	—	NA	Quarterly	Monthly
Dielectric withstanding voltage	3.9.1	E	E	NA	Quarterly	Monthly
Moisture and insulation resistance	3.9.4	E	E	NA	Quarterly	Monthly

<sup>1</sup>Test Coupon A contains the largest component hole and land associated with that hole that can be fitted to a 2.5 mm [0.0984 in] grid.

## APPENDIX A

Appendix A presents the performance requirements of this document in an abbreviated form and alphabetical order. Special conditions, lengthy requirements, and tutorial information may be shortened or partially omitted in this Appendix. See the referenced paragraph in this Appendix for the full specification requirements.

Characteristic	Requirements			Requirement
	Class 1	Class 2	Class 3	Paragraph
Annular ring external	180° breakout accept.	90° breakout accept.	50 µm [0.00197 in] min.	3.4.3 & Tab. 3-5
Annular ring internal	180° breakout accept.	90° breakout accept.	25 µm [0.00098 in] min.	3.4.2 & Tab. 3-5 or 3.6.2.8 & Tab. 3-5
Annular ring, unsupported hole	No breakout	No breakout	150 µm [0.00591 in] min.	3.4.3 & Tab. 3-5
Board dimensions				3.4
Bond enhancement treatment (visual)	Mottled acceptable, missing acceptable if not > 10% of cond. area			3.3.2.5
Bow and twist	Max. of 0.75% for surface mount boards and 1.5% for all others			3.4.4
Burrs and nodules	Accept if min. hole diameter is met and copper thick. Acceptable			3.6.2.1, Tab. 3-6
Cleanliness, ionic	Max. 1.56 µg/cm <sup>2</sup>			3.10.1
Coefficient of thermal expansion	± 2ppm/°C of specified value			3.11.7
Conductor definition				3.5
Conductor imperfections	30% of min. specified in 10% of length or 25 mm [0.984 in], whichever is less	20% of min. specified in 10% of length or 13 mm [0.512 in], whichever is less		3.5.3
Conductor spacing reduction	Minimum spacing <b>shall</b> be as specified on the drawing. If minimum spacing is not specified, the allowed reduction in the nominal conductor spacing may be 30%.		Minimum spacing <b>shall</b> be as specified on the drawing. If minimum spacing is not specified, nominal conductor spacing may be reduced by 20%.	3.5.2
Conductor thickness	If not specified, min. conductor thickness <b>shall</b> be in accordance with 3.6.2.11 and 3.6.2.12			3.5.1
Conductor thickness external copper	See Table 3-8			3.6.2.12
Conductor thickness internal copper foil	See Table 3-7			3.6.2.11
Conductor thickness reduction	Not exceed 30% of min. conductor thickness	Not exceed 20% of min. conductor thickness		3.5.3.2
Conductor width	If not specified, min. conductor width <b>shall</b> be 80% of conductor pattern furnished			3.5.1
Conductor width reduction	Not exceed 30% of min. conductor width	Not exceed 20% of min. conductor width		3.5.3.1
Continuity	Resistance ≤ 50Ω	Resistance ≤ 20Ω		3.9.2.1
Copper purity elongation and tensile strength	Purity <b>shall</b> be no less than 99.5% pure; tensile strength not less than 2500 kg/cm <sup>2</sup> ; elongation not less than 6%			3.2.6.2
Cracks, barrel/corner	None allowed	None allowed	None allowed	3.6.2.1, Tab. 3-6
Cracks, external foil	Allowed if not through plating	Allowed if does not extend into plating	Allowed if does not extend into plating	3.6.2.1, Tab. 3-6
Cracks, internal foil	One side of hole if not through foil thickness	None allowed	None allowed	3.6.2.1, Tab. 3-6



Characteristic	Requirements			Requirement
	Class 1	Class 2	Class 3	Paragraph
Cracks, laminate	Cracks in Zone B not > 150 $\mu\text{m}$ [0.00591 in]	Cracks in Zone B not > 80 $\mu\text{m}$ [0.00315 in]		3.6.2.4
Dewetting conductors and planes	Allowed in all areas without solder connections			3.5.4.4
Dewetting solder connection areas	15% max.	5% max.	5% max.	3.5.4.4
Die bond adhesion				3.11.11
Dielectric thickness	90 $\mu\text{m}$ [0.00354 in] min. if not specified, but may be specified thinner			3.6.2.14
Dielectric withstanding voltage	No requirement	Spacing 80 $\mu\text{m}$ [0.00315 in] or greater, 500Vdc Spacing less than 80 $\mu\text{m}$ [0.00315 in], 250Vdc		3.9.1 & Tab. 3-11
Dielectric withstanding voltage after MIR				3.9.4.1
Edge board connector lands	No defect that exposes copper or nickel, no solder splashes or bumps. Pits, dents or depressions not > 0.15 mm [0.00591 in] and not more than three per contact and not on more than 30% of lands			3.5.4.3
Edge board contacts (visual)				3.3.8 & Tab. 3-4
Exposed copper gap	2.5 mm [0.0984 in] max.	1.25 mm [0.04921 in] max.	0.75 mm [0.0295 in] max.	3.3.8 & Tab. 3-4
Gold overlap	2.5 mm [0.0984 in] max.	1.25 mm [0.04921 in] max.	0.75 mm [0.0295 in] max.	3.3.8 & Tab. 3-4
Edges (visual)	Nicks or haloing not to penetrate more than 50% of the distance from edge to nearest conductor or 2.5 mm [0.0984 in] whichever is less			3.3.1
Electrical requirements				3.9
Etchback (when specified)	5 to 80 $\mu\text{m}$ [0.00020 to 0.00315 in]. Preferred depth 13 $\mu\text{m}$ [0.00051 in]			3.6.2.5
Etchback, negative	25 $\mu\text{m}$ [0.00098 in] max.	25 $\mu\text{m}$ [0.00098 in] max.	13 $\mu\text{m}$ [0.00051 in] max.	3.6.2.7
Final finish coverage				3.5.4.6
Foreign inclusions (visual)	Per IPC-A-600 except no max. dimension			3.3.2.1
Fungus resistance	Board <b>shall not</b> support fungus growth			3.11.3
Glass fiber protrusion	Allowed. See 3.6.2.10			3.6.2.1, Tab 3-6
Hole pattern accuracy and size				3.4.1
Inclusions, innerlayer (inclusions between interface of internal land and through-hole plating)	Allowed on only one side of hole wall on 20% of lands	None allowed	None Allowed	3.6.2.1, Tab. 3-6
Impedance testing				3.11.6
Insulation resistance after exposure to moisture	Maintain elect. function	100 M $\Omega$	500 M $\Omega$	3.9.4, Tab. 3-11
Insulation resistance as rec. (SIR)	Maintain elect. function	500 M $\Omega$	500 M $\Omega$	3.11.9 & Tab. 3-11
Insulation resistance	Resistance > 0.5 M $\Omega$	Resistance > 2.0 M $\Omega$		3.9.2.2
Laminate imperfections (visual)	Blistering, delamination, measling, crazing and haloing to conform to visual acceptance standards in IPC-A-600			3.3.2
Laminate integrity	See voids, laminate			3.6.2.3
Lifted lands	Allowed during microsection evaluation if visual examination criteria is met (3.3.4)			3.6.2.9, Tab. 3-6
Lifted lands (visual)	Not acceptable, if observed during visual examination			3.3.4
Marking (visual)				3.3.5
Material				3.2
Mechanical shock	Board <b>shall</b> pass test requirements of 3.9.2 after mechanical shock			3.11.5
Metal core, horizontal microsection	Wicking, radial cracks lateral spacing or voids in hole-fill <b>shall not</b> reduce electrical spacing to less than 100 $\mu\text{m}$ [0.00394 in]. Penetration of wicking or radial cracks <b>shall not</b> exceed 75 $\mu\text{m}$ [0.00295 in] into hole fill.			3.7.1

Characteristic	Requirements			Requirement
	Class 1	Class 2	Class 3	Paragraph
Metal core, internal spacing	Min. between metal core, core wall, other conductors 100 µm [0.00394 in]			3.6.2.13
Nailheading	Acceptable	Acceptable	Acceptable	3.6.2.16
Negative etchback	25 µm [0.00098 in] max.	25 µm [0.00098 in] max.	13 µm [0.00051 in] max.	3.6.2.7
Nicks and pinholes, connective conductor to planes	Allowed reduction per 3.5.3.1 or 3.5.3.2			3.5.4.1
Nicks and pinholes, planes	Max. size is 1.5 mm [0.0591 in] with not > 6 per side, per 625 cm <sup>2</sup>	Max. size is 1.0 mm [0.03937 in] with not > 4 per side, per 625 cm <sup>2</sup>		3.5.4.1
Nonwetting	None allowed on surfaces where solder connection will be required			3.5.4.5
Organic contamination	No positive identification of organic contamination			3.11.2
Other tests (when specified)				3.7
Outgassing	Not result in weight loss exceeding 0.1%			3.11.1
Pink ring (visual)	Acceptable			3.3.2.6
Plating adhesion (visual)				3.3.7
Plating folds, inclusions	Must be enclosed and min. copper plating thickness is met			3.6.2.1, Tab. 3-6
Plating integrity, plated-through holes	Properties specified in Table 3-6			3.6.2.1
Plating separation	Allowed at the knee, max. length 130 µm [0.00512 in]	None allowed	None allowed	3.6.2.1, Tab. 3-6
Plating thickness, copper, blind vias	Avg. 20 µm [0.00079 in] Min. 18 µm [0.00071 in]	Avg. 20 µm [0.00079 in] Min. 18 µm [0.00071 in]	Avg. 25 µm [0.00098 in] Min. 20 µm [0.00079 in]	3.6.2.10, Tab. 3-2
Plating thickness, copper, buried vias	Avg. 13 µm [0.00051 in] Min. 11 µm [0.00043 in]	Avg. 15 µm [0.00059 in] Min. 13 µm [0.00051 in]	Avg. 15 µm [0.00059 in] Min. 13 µm [0.00051 in]	3.6.2.10, Tab. 3-2
Plating thickness, copper, surface and holes	Avg. 20 µm [0.00079 in] Min. 18 µm [0.00071 in]	Avg. 20 µm [0.00079 in] Min. 18 µm [0.00071 in]	Avg. 25 µm [0.00098 in] Min. 20 µm [0.00079 in]	3.6.2.10, Tab. 3-2
Plating, coating thickness (final finish)	See Table 3-2			3.6.2.10, Tab. 3-2
Repair	As agreed by user and supplier			3.12
Repairs, circuit	As agreed by user and supplier			3.12.1
Resin fill, blind and buried vias	No requirement for blind or buried	No requirement for blind, 60% min. for buried		3.6.2.15
Rework simulation	Not required	Not required	Meet requirement of 3.6 after testing	3.7.2
Scratches, dents, tool marks (visual)	Acceptable if do not bridge conductors or reduce spacing below min.			3.3.2.3
Separation along vertical edge of external land	Acceptable at electroless or direct-plating interface with electrolytic copper plating provided it does not extend into electrolytic plating or beyond the vertical edge of the external copper foil. (See Figure 3-3)			3.6.2.1, Tab. 3-6
Separation, innerlayer (separation between interface of internal land and through-hole plating)	Allowed on only one side of hole wall at 20% of lands	None allowed	None allowed	3.6.2.1, Tab. 3-6
Separation, plating	Allowed at the knee, max. length 130 µm [0.00512 in]	None allowed	None allowed	3.6.2.1, Tab. 3-6
Shorts to metal substrate	Capable of withstanding 500Vdc			3.9.3
Smear removal	Etchback during smear removal <b>shall not</b> exceed 25 µm [0.00098 in]			3.6.2.6
Solder resist (solder mask)				3.8
Solder resist coverage	Conductors not be exposed or bridged by blisters in solder resist areas. For exposed dielectric, encroachment on lands, blistering, pits and voids in dielectric areas, and board edge chipping (see 3.8.1)			3.8.1
Solder resist cure and adhesion	No tackiness; max. loss after tape test per Table 3-9			3.8.2

Characteristic	Requirements			Requirement
	Class 1	Class 2	Class 3	Paragraph
Solderability (visual)				3.3.6
Special requirements (when specified)				3.11
Structural integrity	Performed on microsections taken from test coupons or the production board, normally after thermal stress.			3.6
Surface mount lands	Edge defects not > 30% of length/width of land, internal not > 20% of length/width of land	Edge defects not > 20% of length/width of land, internal not > 10% of length/width of land		3.5.4.2
Thermal shock	<b>Shall</b> meet requirements of Table 3-6 after cycling			3.11.8
Thermal stress	Board <b>shall</b> pass test requirements of IPC-TM-650, Method 2.6.8			3.6.1
Vibration	Board <b>shall</b> pass test requirements of 3.9.2 after vibration cycling			3.11.4
Visual				3.3
Voids, laminate	Voids in Zone B not > 150 µm [0.00591 in]	Voids in Zone B not > 80 µm [0.00315 in]	Voids in Zone B not > 80 µm [0.00315 in]	3.6.2.3
Voids in hole, copper	Three voids	One void, but not on resamples	One void, but not on resamples	3.6.2.2, Tab. 3-6
Voids in hole, copper plating (visual)	Three per hole in not more than 10% of holes, not > 10% hole length.	One per hole in not more than 5% of holes, not > 5% hole length	None	3.3.3 & Tab. 3-3
Voids in hole, final finish plating (visual)	Five per hole in not more than 15% of holes	Three per hole in not more than 5% of holes	One per hole in not more than 5% of holes	3.3.3 & Tab. 3-3
Voids in surface	Acceptable if not > 0.8 mm [0.0315 in] in longest dim. or exceed 5% of area			3.3.2.4
Weave exposure (visual)	Acceptable if conductor spacing is not reduced below min.			3.3.2.2
Wicking	125 µm [0.00492 in] max.	100 µm [0.00393 in] max.	80 µm [0.00315 in] max.	3.6.2.1, Tab. 3-6
Wire bond adhesion				3.11.10
Workmanship (visual)				3.3.9



ASSOCIATION CONNECTING  
ELECTRONICS INDUSTRIES

# ANSI/IPC-T-50 Terms and Definitions for Interconnecting and Packaging Electronic Circuits Definition Submission/Approval Sheet

The purpose of this form is to keep current with terms routinely used in the industry and their definitions. Individuals or companies are invited to comment. Please complete this form and return to:

IPC  
2215 Sanders Road  
Northbrook, IL 60062-6135  
Fax: 847 509.9798

### SUBMITTOR INFORMATION:

Name: \_\_\_\_\_  
Company: \_\_\_\_\_  
City: \_\_\_\_\_  
State/Zip: \_\_\_\_\_  
Telephone: \_\_\_\_\_  
Date: \_\_\_\_\_

- This is a **NEW** term and definition being submitted.
- This is an **ADDITION** to an existing term and definition(s).
- This is a **CHANGE** to an existing definition.

Term	Definition

If space not adequate, use reverse side or attach additional sheet(s).

Artwork:  Not Applicable  Required  To be supplied

Included: Electronic File Name: \_\_\_\_\_

Document(s) to which this term applies: \_\_\_\_\_

Committees affected by this term: \_\_\_\_\_

Office Use	
IPC Office	Committee 2-30
Date Received: _____	Date of Initial Review: _____
Comments Collated: _____	Comment Resolution: _____
Returned for Action: _____	Committee Action: <input type="checkbox"/> Accepted <input type="checkbox"/> Rejected
Revision Inclusion: _____	<input type="checkbox"/> Accept Modify
IEC Classification	
Classification Code • Serial Number	
Terms and Definition Committee Final Approval Authorization:	
Committee 2-30 has approved the above term for release in the next revision.	
Name: _____ Committee: <u>IPC 2-30</u> Date: _____	

## Technical Questions

The IPC staff will research your technical question and attempt to find an appropriate specification interpretation or technical response. Please send your technical query to the technical department via:

tel 847/509-9700

fax 847/509-9798

www.ipc.org

e-mail: answers@ipc.org

## IPC World Wide Web Page [www.ipc.org](http://www.ipc.org)

Our home page provides access to information about upcoming events, publications and videos, membership, and industry activities and services. Visit soon and often.

## IPC Technical Forums

IPC technical forums are opportunities to network on the Internet. It's the best way to get the help you need today! Over 2,500 people are already taking advantage of the excellent peer networking available through e-mail forums provided by IPC. Members use them to get timely, relevant answers to their technical questions.

### TechNet@ipc.org

TechNet forum is for discussion of technical help, comments or questions on IPC specifications, or other technical inquiries. IPC also uses TechNet to announce meetings, important technical issues, surveys, etc.

### ChipNet@ipc.org

ChipNet forum is for discussion of flip chip and related chip scale semiconductor packaging technologies. It is cosponsored by the National Electronics Manufacturing Initiative (NEMI).

### ComplianceNet@ipc.org

ComplianceNet forum covers environmental, safety and related regulations or issues.

### DesignerCouncil@ipc.org

Designers Council forum covers information on upcoming IPC Designers Council activities as well as information, comment, and feedback on current design issues, local chapter meetings, new chapters forming, and other design topics.

### Roadmap@ipc.org

The IPC Roadmap forum is the communication vehicle used by members of the Technical Working Groups (TWGs) who develop the IPC National Technology Roadmap for Electronic Interconnections.

### LeadFree@ipc.org

This forum acts as a peer interaction resource for staying on top of lead elimination activities worldwide and within IPC.

## ADMINISTERING YOUR SUBSCRIPTION STATUS:

All commands (such as subscribe and signoff) must be sent to [listserv@ipc.org](mailto:listserv@ipc.org). Please DO NOT send any command to the mail list address, (i.e. <mail list> @ipc.org), as it would be distributed to all the subscribers.

Example for subscribing:

To: [LISTSERV@IPC.ORG](mailto:LISTSERV@IPC.ORG)

Subject:

Message: subscribe TechNet Joseph H. Smith

Example for signing off:

To: [LISTSERV@IPC.ORG](mailto:LISTSERV@IPC.ORG)

Subject:

Message: sign off DesignerCouncil

Please note you must send messages to the mail list address ONLY from the e-mail address to which you want to apply changes. In other words, if you want to sign off the mail list, you must send the signoff command from the address that you want removed from the mail list. Many participants find it helpful to signoff a list when travelling or on vacation and to resubscribe when back in the office.

## How to post to a forum:

To send a message to all the people currently subscribed to the list, just send to <mail list>@ipc.org. Please note, use the mail list address that you want to reach in place of the <mail list> string in the above instructions.

Example:

To: [TechNet@IPC.ORG](mailto:TechNet@IPC.ORG)

Subject: <your subject>

Message: <your message>

The associated e-mail message text will be distributed to everyone on the list, including the sender. Further information on how to access previous messages sent to the forums will be provided upon subscribing.

For more information, contact Hugo Scaramuzza

tel 847/790-5312

fax 847/509-9798

e-mail: [scarhu@ipc.org](mailto:scarhu@ipc.org)

[www.ipc.org/html/forum.htm](http://www.ipc.org/html/forum.htm)

## Education and Training

IPC conducts local educational workshops and national conferences to help you better understand emerging technologies. National conferences have covered Ball Grid Array and Flip Chip/Chip Scale Packaging. Some workshop topics include:

Printed Wiring Board Fundamentals	High Speed Design
Troubleshooting the PWB Manufacturing Process	Design for Manufacturability
Choosing the Right Base Material Laminate	Design for Assembly
Acceptability of Printed Boards	Designers Certification Preparation
New Design Standards	

### IPC-A-610 Training and Certification Program

“The Acceptability of Electronic Assemblies” (ANSI/IPC-A-610) is the most widely used specification for the PWB assembly industry. An industry consensus Training and Certification program based on the IPC-A-610 is available to your company.

For more information on programs, contact John Riley  
 tel 847/790-5308 fax 847/509-9798  
 e-mail: [rilejo@ipc.org](mailto:rilejo@ipc.org) [www.ipc.org](http://www.ipc.org)

### IPC Video Tapes and CD-ROMs

IPC video tapes and CD-ROMs can increase your industry know-how and on the job effectiveness.

For more information on IPC Video/CD Training, contact Mark Pritchard  
 tel 505/758-7937 ext. 202 fax 505/758-7938  
 e-mail: [markp@ipcvideo.com](mailto:markp@ipcvideo.com) [www.ipc.org](http://www.ipc.org)

### IPC Printed Circuits Expo<sup>SM</sup>

IPC Printed Circuits Expo is the largest trade exhibition in North America devoted to the PWB industry. Over 90 technical presentations make up this superior technical conference.



**April 4-6, 2000**  
 San Diego, California

**April 3-5, 2001**  
 Anaheim, California

**March 26-28, 2002**  
 Long Beach, California

Exhibitor information:  
 Contact: Jeff Naccarato  
 tel 630/434-7779

Registration information:  
 tel 847/790-5361  
 fax 847/509-9798  
 e-mail: [registration@ipc.org](mailto:registration@ipc.org)  
[www.ipcprintedcircuitexpo.org](http://www.ipcprintedcircuitexpo.org)

### APEX<sup>SM</sup> / IPC SMEMA Council Electronics Assembly Process Exhibition & Conference

APEX is the premier technical conference and exhibition dedicated entirely to the PWB assembly industry.



**March 14-16, 2000**  
 Long Beach, California

**January 16-18, 2001**  
 San Diego, California

**Spring 2002**  
 TBA

Exhibitor information:  
 Contact: Mary MacKinnon  
 tel 847/790-5386

Registration information:  
 APEX Hotline: tel 877/472-4724  
 fax 847/790-5361  
 e-mail: [apex2000@ipc.org](mailto:apex2000@ipc.org)  
[www.apex2000.org](http://www.apex2000.org)

### How to Get Involved

The first step is to join IPC. An application for membership can be found in the back of this publication. Once you become a member, the opportunities to enhance your competitiveness are vast. Join a technical committee and learn from our industry's best while you help develop the standards for our industry. Participate in market research programs which forecast the future of our industry. Participate in Capitol Hill Day and lobby your Congressmen and Senators for better industry support. Pick from a wide variety of educational opportunities: workshops, tutorials, and conferences. More up-to-date details on IPC opportunities can be found on our web page: [www.ipc.org](http://www.ipc.org).

For information on how to get involved, contact:  
 Jeanette Ferdman, Membership Manager  
 tel 847/790-5309 fax 847/509-9798  
 e-mail: [JeanetteFerdman@ipc.org](mailto:JeanetteFerdman@ipc.org) [www.ipc.org](http://www.ipc.org)



ASSOCIATION CONNECTING  
ELECTRONICS INDUSTRIES

# Application

# for Site Membership

Thank you for your decision to join IPC. IPC Membership is **site specific**, which means that IPC member benefits are available to all individuals employed at the site designated on the other side of this application.

PLEASE CHECK  
APPROPRIATE  
CATEGORY

To help IPC serve your member site in the most efficient manner possible, please tell us what your facility does by choosing the most appropriate member category.



**INDEPENDENT  
PRINTED  
BOARD  
MANUFACTURERS**

Our facility manufactures and sells to other companies, printed wiring boards or other electronic interconnection products on the merchant market.

WHAT PRODUCTS DO YOU  
MAKE FOR SALE?

- |   |  |  |
|---|--|--|
| <input type="checkbox"/> One-sided and two-sided rigid printed boards | <input type="checkbox"/> Flexible printed boards | <input type="checkbox"/> Discrete wiring devices |
| <input type="checkbox"/> Multilayer printed boards                    | <input type="checkbox"/> Flat cable              | <input type="checkbox"/> Other interconnections  |
|   | <input type="checkbox"/> Hybrid circuits         |  |

Name of Chief Executive Officer/President \_\_\_\_\_



**INDEPENDENT  
PRINTED BOARD  
ASSEMBLERS  
EMSI  
COMPANIES**

Our facility assembles printed wiring boards on a contract basis and/or offers other electronic interconnection products for sale.

- |  |   |                                      |
|--|---|--------------------------------------|
| <input type="checkbox"/> Turnkey               | <input type="checkbox"/> Through-hole     | <input type="checkbox"/> Consignment |
| <input type="checkbox"/> SMT                   | <input type="checkbox"/> Mixed Technology | <input type="checkbox"/> BGA         |
| <input type="checkbox"/> Chip Scale Technology |   |                                      |

Name of Chief Executive Officer/President \_\_\_\_\_



**OEM –  
MANUFACTURERS  
OF ANY END  
PRODUCT USING  
PCB/PCAs  
OR CAPTIVE  
MANUFACTURERS  
OF PCBs/PCAs**

Our facility purchases, uses and/or manufactures printed wiring boards or other electronic interconnection products for our own use in a final product. Also known as original equipment manufacturers (OEM).

IS YOUR INTEREST IN:

- purchasing/manufacture of printed circuit boards
- purchasing/manufacturing printed circuit assemblies

What is your company's main product line?  
\_\_\_\_\_



**INDUSTRY  
SUPPLIERS**

Our facility supplies raw materials, machinery, equipment or services used in the manufacture or assembly of electronic interconnection products.

What products do you supply?  
\_\_\_\_\_



**GOVERNMENT  
AGENCIES/  
ACADEMIC  
TECHNICAL  
LIAISONS**

We are representatives of a government agency, university, college, technical institute who are directly concerned with design, research, and utilization of electronic interconnection devices. (Must be a non-profit or not-for-profit organization.)

**Please be sure to complete both pages of application.**

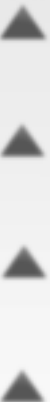

# Application for

# Site Membership



ASSOCIATION CONNECTING  
ELECTRONICS INDUSTRIES

Company Name \_\_\_\_\_

Street Address \_\_\_\_\_

City \_\_\_\_\_ State \_\_\_\_\_ Zip \_\_\_\_\_ Country \_\_\_\_\_

Main Phone No. \_\_\_\_\_ Fax \_\_\_\_\_

Primary Contact Name \_\_\_\_\_

Title \_\_\_\_\_ Mail Stop \_\_\_\_\_

Phone \_\_\_\_\_ Fax \_\_\_\_\_ e-mail \_\_\_\_\_

Senior Management Contact \_\_\_\_\_

Title \_\_\_\_\_ Mail Stop \_\_\_\_\_

Phone \_\_\_\_\_ Fax \_\_\_\_\_ e-mail \_\_\_\_\_

## Please check one:

- \$1,000.00 Annual dues for Primary Site Membership (Twelve months of IPC membership begins from the time the application and payment are received)
- \$800.00 Annual dues for Additional Facility Membership: Additional membership for a site within an organization where another site is considered to be the primary IPC member.
- \$600.00\*\* Annual dues for an independent PCB/PWA fabricator or independent EMSI provider with annual sales of less than \$1,000,000.00. \*\*Please provide proof of annual sales.
- \$250.00 Annual dues for Government Agency/University/not-for-profit organization

**TMRC Membership**  Please send me information on Membership in the Technology Marketing Research Council (TMRC)

**AMRC Membership**  Please send me information for Membership in the Assembly Marketing Research Council (AMRC)

## Payment Information

Enclosed is our check for \$ \_\_\_\_\_

Please bill my credit card: (circle one) MC AMEX VISA DINERS

Card No. \_\_\_\_\_ Exp date \_\_\_\_\_

Authorized Signature \_\_\_\_\_

**Mail application with  
check or money order to:**

IPC  
Dept. 851-0117W  
P.O. Box 94020  
Palatine, IL 60094-4020

**Fax/Mail application with  
credit card payment to:**

IPC  
2215 Sanders Road  
Northbrook, IL 60062-6135  
Tel: 847 509.9700  
Fax: 847 509.9798

PLEASE ATTACH BUSINESS CARD  
OF OFFICIAL REPRESENTATIVE HERE





ASSOCIATION CONNECTING  
ELECTRONICS INDUSTRIES

# Standard Improvement Form IPC-6012A with Amendment 1

The purpose of this form is to provide the Technical Committee of IPC with input from the industry regarding usage of the subject standard.

Individuals or companies are invited to submit comments to IPC. All comments will be collected and dispersed to the appropriate committee(s).

If you can provide input, please complete this form and return to:

IPC  
2215 Sanders Road  
Northbrook, IL 60062-6135  
Fax 847 509.9798

---

1. I recommend changes to the following:

- Requirement, paragraph number \_\_\_\_\_
- Test Method number \_\_\_\_\_, paragraph number \_\_\_\_\_

The referenced paragraph number has proven to be:

- Unclear    Too Rigid    In Error
- Other \_\_\_\_\_

---

2. Recommendations for correction:

---

---

---

---

---

---

3. Other suggestions for document improvement:

---

---

---

---

---

---

Submitted by:

Name \_\_\_\_\_ Telephone \_\_\_\_\_

Company \_\_\_\_\_ E-mail \_\_\_\_\_

Address \_\_\_\_\_

City/State/Zip \_\_\_\_\_ Date \_\_\_\_\_

---



ASSOCIATION CONNECTING  
ELECTRONICS INDUSTRIES

ISBN #1-580982-60-3

2215 Sanders Road, Northbrook, IL 60062-6135  
Tel. 847.509.9700 Fax 847.509.9798  
[www.ipc.org](http://www.ipc.org)