

Title	<i>Engineering Prototype Report - 70 W (19 V 3.66A) Universal Input Adapter (EP11)</i>
Target Applications	Laptop Adapters, LCD Monitors, Audio, High Power Adapters
Author	Power Integrations Applications Dept.
Doc Num	EPR-00011
Date	22-January-2001
Revision	1.4

Features

- Very compact design: (4.1" × 2.25" × 1.06")
- High power density - 7 W / inch³
- Full output power (70 W) in sealed enclosure at 40°C ambient
- High efficiency: 84% (85 V_{AC}), 89% (230 V_{AC})
- Low no-load consumption: 350 mW (115 V_{AC}), 500 mW (230 V_{AC})
- Low value input capacitor: 74% DC_{MAX} and line feed forward allows 2 μF/W
- Power limited during overload: overload output current less than 5 A at 19 V
- Primary side soft-start: minimizes component stresses during start-up
- Low EMI due to frequency jittering: meets CISPR22B with output cap. earthed
- Line under voltage sense: no output glitches on power up or power down
- Line over voltage shutdown: extended line surge protection
- Hysteretic thermal shutdown: supply automatically recovers when fault is removed
- Low component count: simple circuit and design
- Single sided PC board: no plated through holes
- No surface mount components required

Table of Contents

1	Introduction.....	4
2	Power Supply Specification	6
3	Schematic.....	7
3.1	Description.....	7
4	PCB Layout.....	10
5	Bill of Materials	11
6	Transformer Documentation	12
6.1	Transformer Sources	14
7	Transformer Spreadsheet.....	15
8	Performance Data.....	17
8.1	Efficiency.....	17
8.2	No-load input power.....	18
8.3	Regulation / Power Limiting	18
9	Thermal Performance	20
10	Waveform Scope Plots	24
10.1	Drain Voltage and Current During Normal Operation.....	24
10.2	Output Voltage During Power-up.....	25
10.3	Output Voltage During Power-down	26
10.4	Drain Voltage and Current during Power-Up (265 V _{AC}).....	26
10.5	DRAIN Current During Power-Up and Power-Down.....	27
10.6	Load Transient response (15 to 100% load change)	28
10.6.1	15 to 100% load change, 85 V _{AC}	28
10.7	Load Transient response (0 to 50% load change)	29
10.7.1	0 to 50% load change, 85 V _{AC}	29
10.7.2	0 to 50% load change, 130 V _{AC}	29
10.7.3	0 to 50% load change, 130 V _{AC}	30
10.8	Ripple Measurements.....	30
10.8.1	DC Ripple Measurement Technique.....	30
10.8.2	Ripple Measurement Results.....	31
11	Control Loop Characteristics	32
11.1	Gain Phase Results.....	33
12	Conducted EMI Scans	36

Important Note:

Although the EP11 is designed to satisfy safety isolation requirements, the engineering prototype has not been agency approved. Therefore all testing should be performed using an isolation transformer to provide the AC input to the prototype board



- 13 Appendix A - Thermal considerations: 37
 - 13.1 Efficiency: 38
 - 13.2 Heat Sinking: 38
 - 13.3 Heat Spreading and Enclosure Surface Temperature: 39
 - 13.4 Component Temperature: 39
 - 13.5 Conclusion: 40
- 14 Appendix B - Custom Component Documentation:..... 41
 - 14.1 Toroid Filter Inductor (L2): 41
 - 14.2 Output Inductor (L1)..... 42
 - 14.3 Heat sink #1 (TOPSwitch-GX and Input Bridge) 43
 - 14.4 Heat sink #2 (Output Diodes) 43
- 15 Revision History 44



1 Introduction

This document is an engineering report that describes a universal input power supply that utilises a TOP249Y. This supply is an off-line flyback converter that operates in continuous mode. Below is a list of notable features:

- Very compact design: (4.1"×2.25"×1.06" internal box dimensions)
- High power density - 7 W / inch³
- Full output power in sealed enclosure at 40°C ambient
- High efficiency: 84% (85 VAC), 89% (230 VAC)
- Low no-load consumption: 350mW (115 VAC), 500 mW (230 VAC)
- Low value input capacitor: extended maximum duty cycle allows 2μF/W
- Power limited during overload: overload output current < 5 A at 19 V
- Primary side soft-start: minimizes component stresses during start-up
- Low EMI due to frequency jittering: meets CISPR22 B / EN55022 B with output earthed
- Line under voltage sense: no output glitches on power up or power down
- Line over voltage shutdown: extended line surge protection
- Hysteretic thermal shutdown: supply automatically recovers when fault is removed
- Low component count: simple circuit and design
- Single sided PC board: no plated through holes
- No surface mount components required

This board demonstrates the basic performance features and the increased power capability of the new **TOPSwitch-GX** family. It was designed to allow testing within the enclosure of a commercial laptop power adapter. This enclosure was used for the thermal testing in section 9.

This document contains the power supply specification, schematic, bill of materials and transformer documentation. Typical operating characteristics are presented at the rear of the report and consist of performance curves and scope waveforms



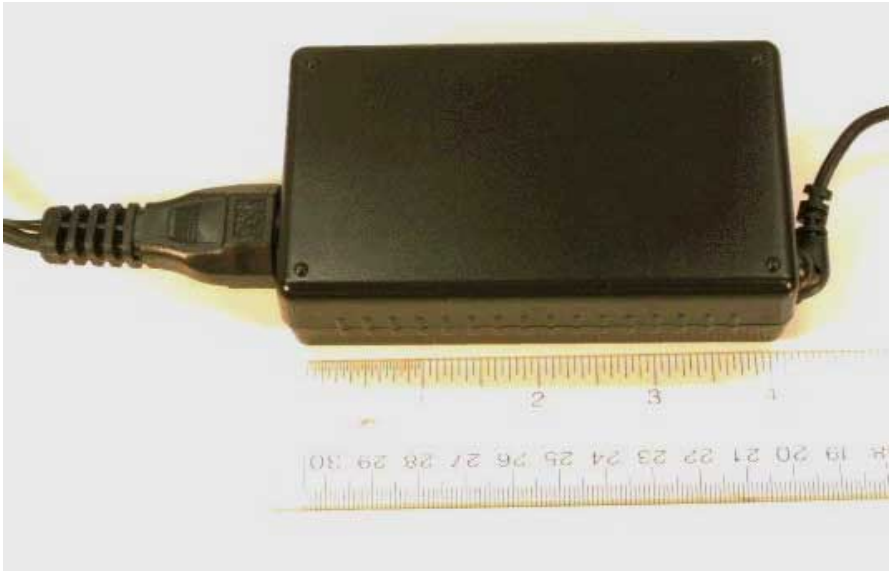

Figure 1 - EP11 Inside Commercial Laptop Enclosure
(4.25 x 2.5 x 1.2" / 108 x 64 x 30mm – external diemonsions)

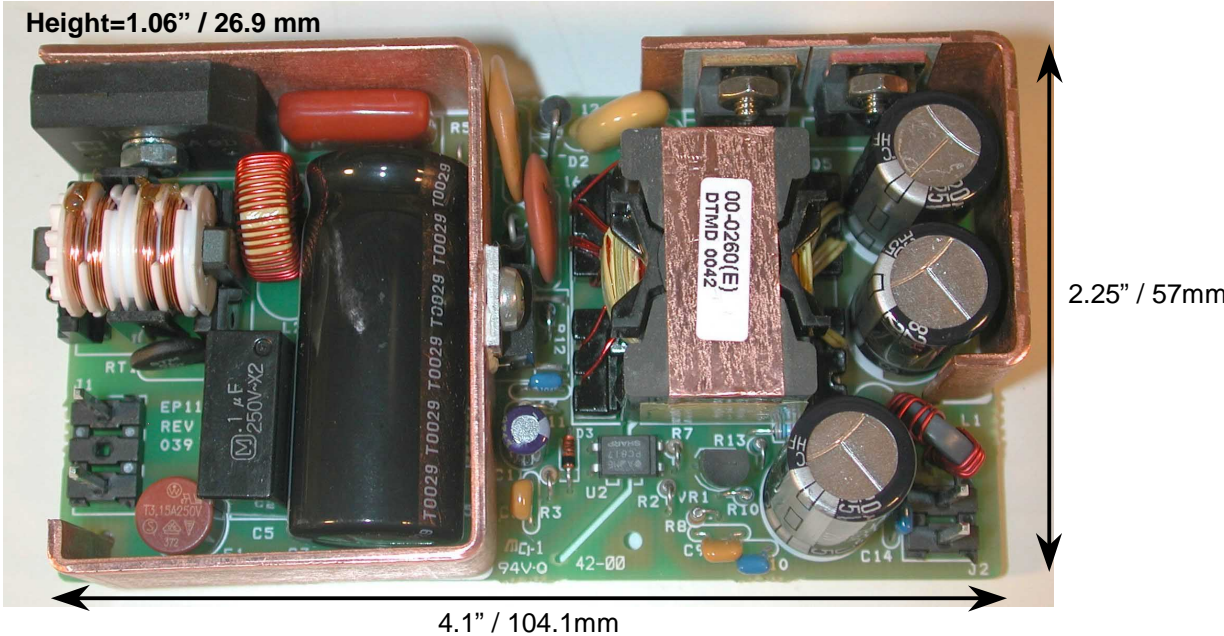

Figure 2 - EP11 Populated Circuit Board (dimensions include heat spreader not shown)



2 Power Supply Specification

Description	Symbol	Min	Typ	Max	Units	Comment
Input						
Input Voltage	V_{IN}	85	115/230	265	V_{AC}	
Input Frequency	f	47	50/60	64	Hz	
No-load Input Power (115 V_{AC})			370		mW	See fig 7
No-load Input Power (230 V_{AC})			520		mW	See fig 7
Output						
Output Voltage	V_{OUT}	18.7	19.2	19.7	V_{DC}^{\dagger}	At output terminals
Output Ripple Voltage	V_{RIPPLE}			120	mV _{p-p}	20 MHz BW
Output Current	I_{OUT}	0		3.66	A_{DC}	
Continuous Output Power	P_{OUT}	0		70	W	
Total Regulation \ddagger		-2		+2	%	0 – 100% load, 85 – 265 V_{AC}
Efficiency (85 V_{AC})		84			%	At full load
Efficiency (230 V_{AC})	η	89			%	
Environmental						
Conducted EMI						Meets CISPR22 B
Safety						Designed to meet IEC950
External Ambient Temperature	T_{AMB}	0	25	40	$^{\circ}C$	In enclosure with natural convection (see section 9)

\dagger Output voltage tolerance may be improved through choice of feedback components.

\ddagger Nominal output voltage for purposes of determining regulation limits is measured at 115 V_{AC} input and 3.66 A output current.

Table 1 - Power supply specification



3 Schematic

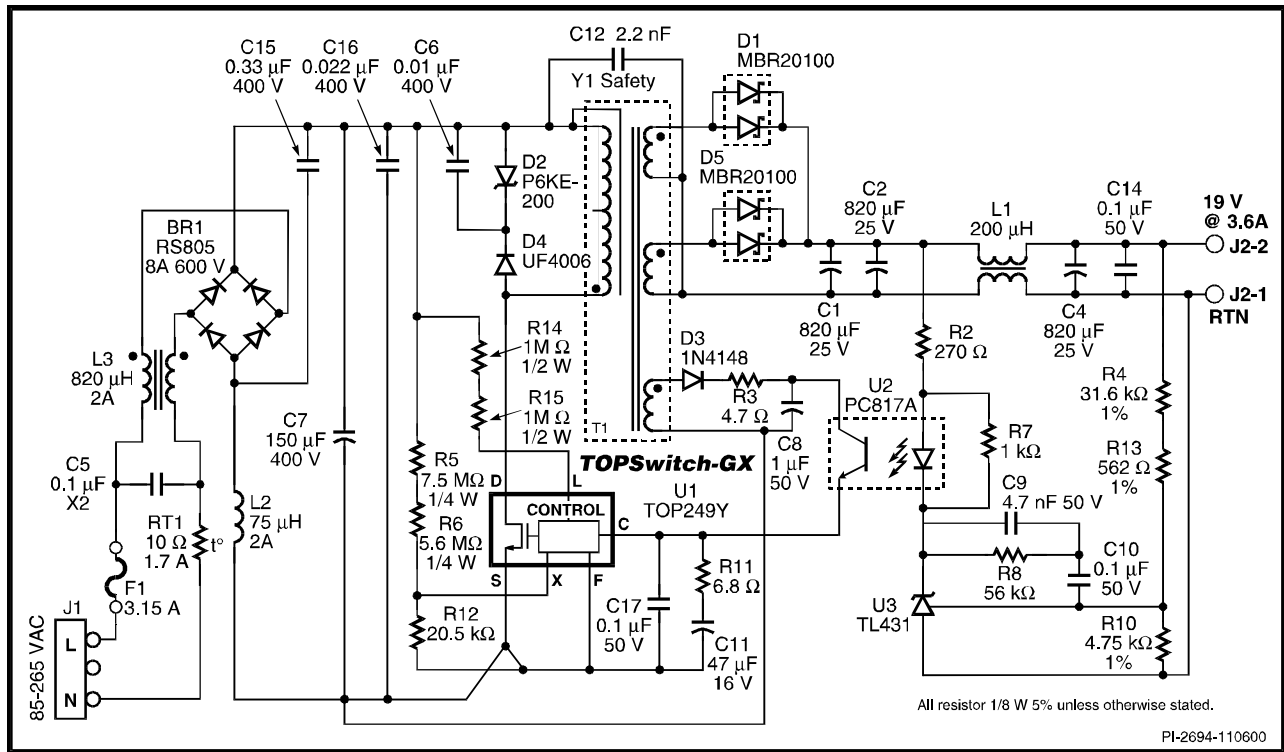

Figure 3 - 70W TOP249Y Power Supply Schematic

3.1 Description

The EP11 is a low-cost flyback switching power supply using the TOP249Y integrated circuit from the *TOPSwitch-GX* family. The circuit shown in Figure 3 details a 19 V, 70 W supply that operates from an input range of 85 to 265 V_{AC}, suitable for applications requiring either an open frame supply or an enclosed adapter.

AC power is rectified and filtered by BR1 and C7 to create the high voltage DC bus applied to the primary winding of transformer (T1). Only a 150μF capacitor is required (2.1 μF/W) due to the wider DC_{MAX} of *TOPSwitch-GX* and the line feed forward function provided by the LINE SENSE Pin. The other side of the primary is driven by the integrated high-voltage MOSFET within the TOP249Y. Diodes, D4 and D2 clamp the DRAIN voltage spike caused by transformer leakage inductance to a safe value below the 700 V maximum. Capacitor C6 is added in parallel with D2 to reduce zener clamp dissipation.

The *TOPSwitch-GX* family provides new operating features and extended specifications. The EP11 power supply is designed using several of these features. Resistors R14 and R15 connected to the LINE SENSE pin (L) of *TOPSwitch-GX* (U1) are used to implement

an under-voltage detect (100V), over-voltage shutdown (450V) and line feed forward with DC_{MAX} reduction features. Two resistors are used in series to allow low cost $\frac{1}{4}$ W resistors which have a lower voltage rating.

The under-voltage detect ensures that the output is glitch free at start-up and shutdown. With the combined value of R14 and R15 as shown, the power supply does not start operating until the DC rail voltage reaches 100 VDC. On removal of the AC input the UV sense prevents the output glitching as C7 discharges turning off the *TOPSwitch-GX* when output regulation is lost or when the input voltage falls to 40 V, whichever occurs first.

The over-voltage feature shuts down the supply if the rectified input voltage exceeds approximately 450V. If exceeded this protects the *TOPSwitch-GX* from excessive drain voltages providing an extended AC surge withstand to 700 V_{DC} (BV_{DSS} rating), ideal for countries with poor power quality.

Finally the line feed forward feature reduces output line frequency ripple by modulating the control loop with the line frequency ripple on the DC rail, ideal when using a relatively small input capacitor.

Resistors R5, R6, and R12 connect to the EXTERNAL CURRENT LIMIT pin (X) and are used to externally program the current limit level of the device to just above the operating peak current at full load and low line. This allows use of a smaller transformer core and / or higher transformer primary inductance for a given output power. Reducing transformer size and *TOPSwitch-GX* power dissipation, while at the same time avoiding transformer core saturation during start-up or output load transient. This resistor network also reduces the current limit with increasing line voltage. This limits the maximum available power during overload conditions at high line (see Figure 10) removing the need for any protection circuitry on the secondary.

The secondary windings are rectified and filtered by D1, D5, C1, and create the 19 V output voltage. Two windings are used, with separate dual rectifiers (for equal current sharing), to lower winding losses and maximise efficiency. Inductor L1 provided additional filtering in conjunction with C4 and C14.

The 19 V output is directly sensed by the series combination of R4 and R13 that form a divider with R10. These resistors together with the reference node voltage of U3 set the output voltage. Other output voltages are also possible by adjusting the transformer turns ratios and value of R4 and R13. Resistor R2 sets the overall DC gain of the control loop and R7 provides bias for voltage reference U3. Capacitor C11 is the main compensation capacitor and together with R11, C9, R8 and C10 ensure stability of the control loop.

The *TOPSwitch-GX* control circuit allows the switching frequency to reduce at light or zero load conditions, eliminating the need for a pre-load resistor to control the output



voltage at zero load. By lowering the switching frequency, no-load power consumption is also greatly reduced.

The bias winding is rectified and filtered by D3, R3 and C8 to create a bias voltage to power the TOP249Y. A 1 μ F capacitor is required for C8 to maintain sufficient voltage during zero to full load transients. Resistor R8 provides leakage inductance filtering to prevent peak charging. A ceramic capacitor is shown for C8 however for lower cost an electrolytic type can be used.

Common mode choke L3 and capacitor C12 attenuate common-mode emission currents caused by high-voltage switching waveforms on the drain side of the primary winding and the primary to secondary capacitance. Inductor L2 in conjunction with C5, C15 and C16 attenuate differential-mode emission currents caused by the fundamental and harmonics of the primary current waveform.

Capacitor C16 provides a high frequency bypass of C7 which shortens the loop formed by these high frequencies passing through the transformer primary and thus reduces both the differential and common mode conducted noise.

Frequency jitter is employed by the *TOPSwitch-GX* family to reduce the conducted noise as measured for both the CISPR and EN standards (see section 12)

Capacitor C17 filters internal MOSFET gate-drive charge current spikes on the CONTROL pin and together with R11 and C11 determines the auto-restart frequency.



4 PCB Layout

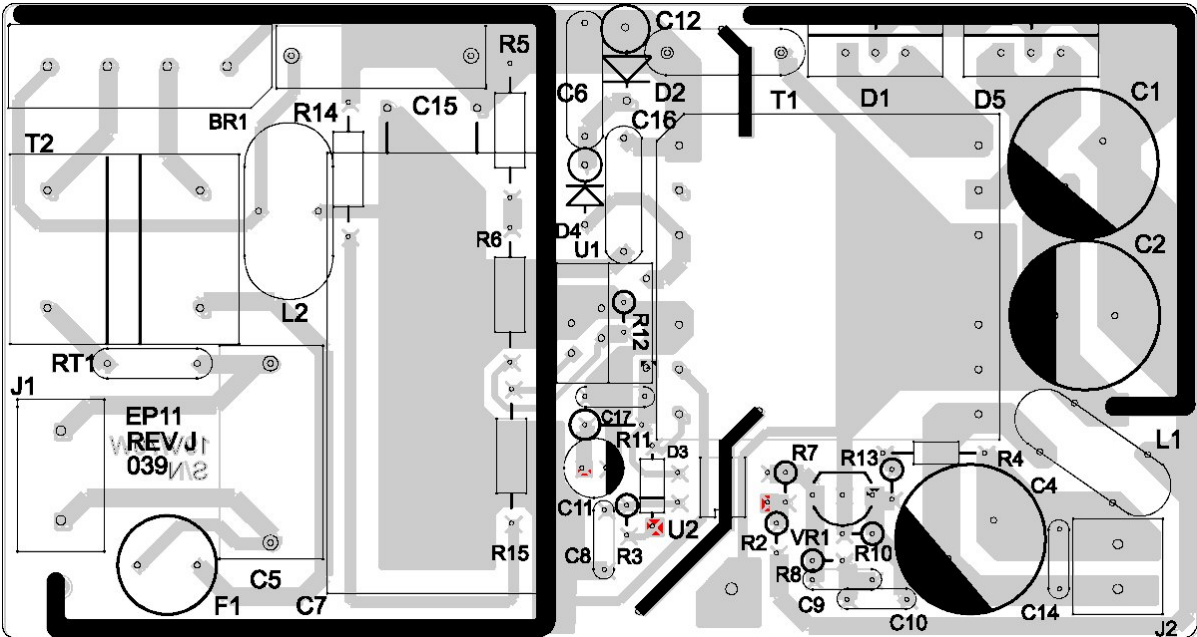

Figure 4 - PCB layout (not to scale)



5 Bill of Materials

EP11 - 19.2V, 3.66A Universal Input Flyback

Item	Qty.	Reference	Part	Comment
1	1	BR1	RS805	
2	3	C1, C2, C4	820uF 25V	
3	1	C5	0.1uF	X2 Safety 250VAC
4	1	C6	0.01uF 400V	
5	1	C7	150uF 400V	
6	1	C8	1.0uF 50V	
7	1	C9	0.0047uF 50V	
8	3	C10, C14, C17	0.1uF 50V	
9	1	C11	47uF 16V	
10	1	C12	.0022uF	Y1 Safety 250VAC
11	1	C15	0.33uF 400V	
12	1	C16	0.02uF 500V	
13	2	D5, D1	MBR20100	
14	1	D2	P6KE200A	
15	1	D3	1N4148	
16	1	D4	UF4006	
17	1	F1	3.15A, 250V	
18	1	J1	Molex Header	
19	1	J2	Molex Header	
20	1	L1	200uH	(custom –see appendix)
21	1	L2	75uH	(custom –see appendix)
22	1	L3	CM Choke	820uH 2.0A
23	1	RT1	10 Ohm 1.7A	In-rush limiter (Keystone CL 120)
24	1	R2	270 1/8W	
25	1	R3	4.7 1/8W	
26	1	R4	31.6K 1/8W 1%	
27	1	R5	7.5M 1/4W	
28	1	R6	5.6M 1/4W	
29	1	R7	1.0K 1/8W	
30	1	R8	56K 1/8W	
31	1	R10	4.75K 1/8W 1%	
32	1	R11	6.8 1/8W	
33	1	R12	20.5K 1/8W	
34	1	R13	562 1/8W 1%	
35	2	R14, R15	1M 1/4W	
36	1	T1	PQ26/20 Core Transformer - revision F (custom – see appendix)	
37	1	U1	TOP249Y	
38	1	U2	PC817A	
39	1	U3	TL431CLP	
40	1	HS1	Copper Heat Sink EP11-HS1D	
41	1	HS2	Copper Heat Sink EP11-HS2D	



6 Transformer Documentation

Transformer, T1 (rev. F)

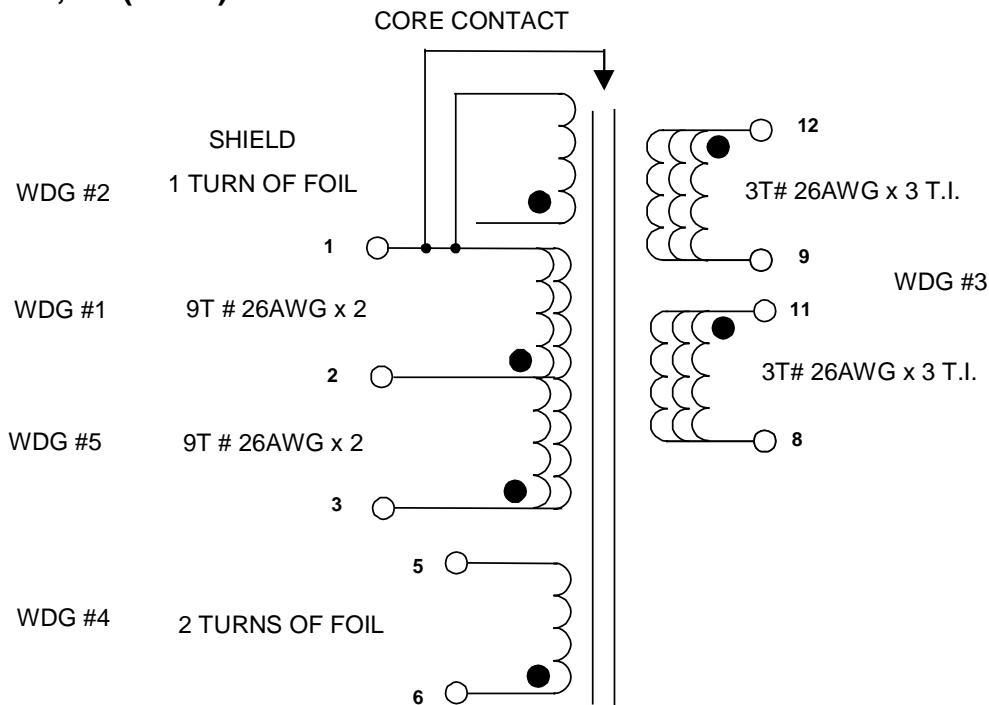

ELECTRICAL SPECIFICATIONS:

Electrical strength	60 Hz 1 minute, from Pins 2-6 to Pins 8-12	3000 VAC
Primary Inductance	Pins 1-3; all windings open. Measure at 130kHz	273μH +/-10%
Resonant Frequency	Pins 1-3; all windings open.	1.3 MHz (Min.)
Primary leakage inductance	Pins 1-3; Pins 8,9,11, 12 shorted. Measure at 130kHz.	3μH (Max)

MATERIALS:

Item	Description
[1]	Core: FPQ26/20-A, TDK PC40 (or equivalent); gapped for $ALG=843nH/T^2$ Lower loss ferrite can be substituted to obtain lower core temperatures.
[2]	Bobbin: TDK BPQ26/20-1112CP (or equivalent)
[3]	Magnet Wire: # 26 AWG Solderable Double Coated
[4]	Triple Insulated Wire: # 26AWG
[5]	Copper foil; 8mm wide Thickness=0.051mm (.002")
[6]	Copper foil tape; 3M 1181 (or equivalent) 11mm wide
[7]	Tape: 3M 74 Polyester Film (or equivalent) 12mm wide
[8]	Tape: 3M 74 Polyester Film (or equivalent) 9.2mm wide
[9]	Varnish
[10]	Tape: 3M 1298 Polyester Film (or equivalent) 19.5mm wide



TRANSFORMER DIAGRAM:

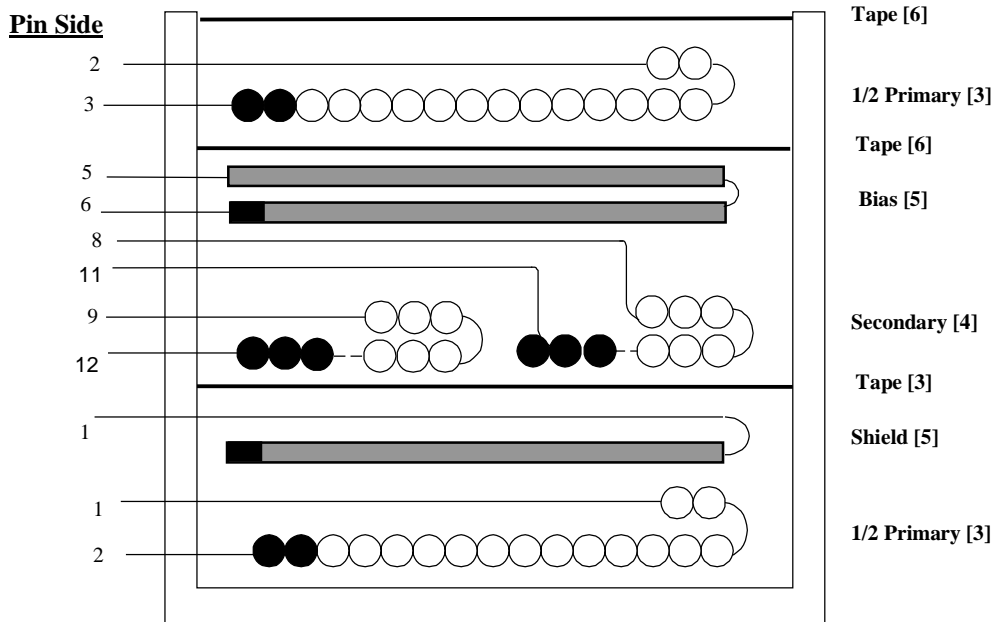

SHIELD and BIAS Winding PREPARATION:

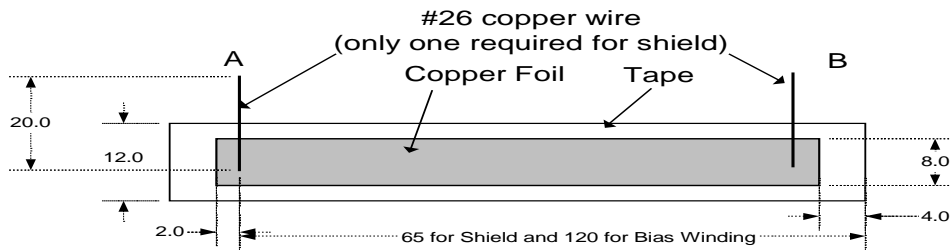

Figure 1-A
(Top View before folding tape)

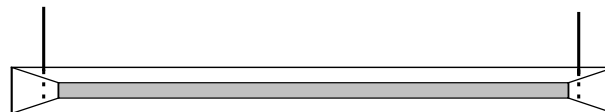

Figure 1-B
(Top View after folding tape)

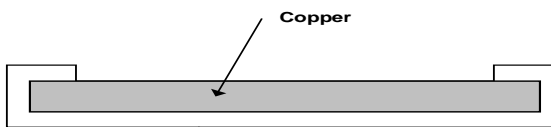
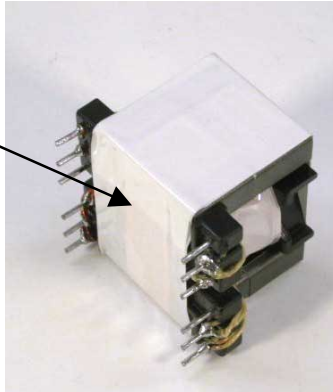

Figure 1-C
(Cross Section)



Due to proximity of secondary components (R4, R13), wrap one layer of tape [10] around core.



TRANSFORMER CONSTRUCTION:

1/2 Primary Winding	Start at pin 2. Wind 9 turns of 2 parallel strands of item [3] from left to right. Wind a single layer and finish at pin 1.
Shield Band (*see diagram)	Prepare cuffed foil [5]. Start at unterminated end of foil and wind one (1) complete turn of foil around bobbin. Terminate at pin 1 and cover with tape [8].
Secondary Winding	Attach Tri-filar item [4] to pin 12. Attach Tri-filar item [4] to pin 11. Interleaving windings, wind across the bobbin. From pin 12, wind 3 turns and finish at pin 9. From pin 11, wind 3 turns and finish at pin 8.
Foil Band (*see diagram)	Prepare cuffed foil [5]. Start at pin 6 and wind 2 complete turns of foil around bobbin and terminate at pin 5.
Basic Insulation	1 layer of tape [8] for insulation.
1/2 Primary Winding	Start at pin 3. Wind 9 turns of 2 parallel strands of item [3] from left to right. Wind a single layer and finish at pin 2.
Basic Insulation	1 layer of tape [8] for insulation.
Core	Affix center gapped core to bobbin.
Final Assembly and Core Contact	Wrap core with copper foil tape [6] Attach wire to pin 1 and to copper tape.
Apply Tape to outside of Core	Wrap one layer of tape [10] around core. (see figure above)
Impregnation	Varnish Impregnate using [9]

6.1 Transformer Sources

For information on the vendors used to source the transformer, please visit our website at the address below and select Engineering Prototype Boards

<http://www.powerint.com/componentsuppliers.htm>



7 Transformer Spreadsheet

ACDC_TOPGX_Rev0.2_090100 © Power Integrations Inc. 2000		INPUT	INFO	OUTPUT	UNIT	TOP_GX_090100.xls: TOPSwitch-GX Continuous/Discontinuous, Flyback Transformer Design Spreadsheet
ENTER APPLICATION VARIABLES						
VACMIN		85			Volts	Minimum AC Input Voltage
VACMAX		265			Volts	Maximum AC Input Voltage
fL		50			Hertz	AC Mains Frequency
VO		19.2			Volts	Output Voltage
PO		70			Watts	Output Power
n		0.85				Efficiency Estimate
Z		0.5				Loss Allocation Factor
VB		12			Volts	Bias Voltage
tC		3			mSeconds	Bridge Rectifier Conduction Time Estimate
CIN		150			uFarads	Input Filter Capacitor
ENTER TOPSWITCH-FX VARIABLES						
TOP-FX		top249			<i>Universal</i>	<i>115 Doubled/230V</i>
Chosen Device			<i>TOP249</i>	<i>Pout</i>	<i>135W</i>	<i>300W</i>
KI		0.55				External Ilimit reduction factor (KI=1.0 for default ILIMIT, KI <1.0 for lower ILIMIT)
ILIMITMIN					2.67 Amps	Use 1% resistor in setting external ILIMIT
ILIMITMAX					3.18 Amps	Use 1% resistor in setting external ILIMIT
Frequency - (F)=130kHz, (H)=65kHz					f	Full (F) frequency option - 130kHz
fS		132000			132000 Hertz	TOPSwitch-FX Switching Frequency: Choose between 132 kHz and 66 kHz
fSmin					124000 Hertz	TOPSwitch-FX Minimum Switching Frequency
fSmax					140000 Hertz	TOPSwitch-FX Maximum Switching Frequency
VOR		120			Volts	Reflected Output Voltage
VDS		8			Volts	TOPSwitch on-state Drain to Source Voltage
VD		0.7			Volts	Output Winding Diode Forward Voltage Drop
VDB		0.7			Volts	Bias Winding Diode Forward Voltage Drop
KP		0.60				Ripple to Peak Current Ratio (0.4 < KRP < 1.0 : 1.0 < KDP < 6.0)
ENTER TRANSFORMER CORE/CONSTRUCTION VARIABLES						
Core Type		PQ26/2				
Core		0			#N/A	P/N: #N/A
Bobbin					#N/A	P/N: #N/A
AE					1.19	1.19 cm^2
LE					0.463	0.463 cm
AL					6170	6170 nH/T^2
BW					9.2	9.2 mm
M		0				mm
L		1.4				
NS		3				



DC INPUT VOLTAGE**PARAMETERS**

VMIN	82 Volts	Minimum DC Input Voltage
VMAX	375 Volts	Maximum DC Input Voltage

CURRENT WAVEFORM SHAPE**PARAMETERS**

DMAX	0.62	Maximum Duty Cycle
IAVG	1.00 Amps	Average Primary Current
IP	2.32 Amps	Peak Primary Current
IR	1.39 Amps	Primary Ripple Current
IRMS	1.31 Amps	Primary RMS Current

TRANSFORMER PRIMARY DESIGN**PARAMETERS**

LP	273 uHenries	Primary Inductance
NP	18	Primary Winding Number of Turns
NB	2	Bias Winding Number of Turns
ALG	834 nH/T ²	Gapped Core Effective Inductance
BM	2934 Gauss	Maximum Flux Density at PO, VMIN (BM<3000)
BP	4140 Gauss	Peak Flux Density (BP<4200)
BAC	880 Gauss	AC Flux Density for Core Loss Curves (0.5 X Peak to Peak)
ur	191	Relative Permeability of Ungapped Core
LG	0.16 mm	Gap Length (Lg > 0.1 mm)
BWE	12.88 mm	Effective Bobbin Width
OD	0.71 mm	Maximum Primary Wire Diameter including insulation
INS	0.07 mm	Estimated Total Insulation Thickness (= 2 * film thickness)
DIA	0.64 mm	Bare conductor diameter
AWG	23 AWG	Primary Wire Gauge (Rounded to next smaller standard AWG value)
CM	512 Cmils	Bare conductor effective area in circular mils
CMA	390 Cmils/Am _p	Primary Winding Current Capacity (200 < CMA < 500)

**TRANSFORMER SECONDARY DESIGN
PARAMETERS (SINGLE OUTPUT / SINGLE
OUTPUT EQUIVALENT)****Lumped parameters**

ISP	13.96 Amps	Peak Secondary Current
ISRMS	6.22 Amps	Secondary RMS Current
IO	3.65 Amps	Power Supply Output Current
IRIPPLE	5.05 Amps	Output Capacitor RMS Ripple Current
CMS	1245 Cmils	Secondary Bare Conductor minimum circular mils
AWGS	19 AWG	Secondary Wire Gauge (Rounded up to next larger standard AWG value)
DIAS	0.91 mm	Secondary Minimum Bare Conductor Diameter
ODS	3.07 mm	Secondary Maximum Outside Diameter for Triple Insulated Wire
INSS	1.08 mm	Maximum Secondary Insulation Wall Thickness

VOLTAGE STRESS**PARAMETERS**

VDRAIN	647 Volts	Maximum Drain Voltage Estimate (Includes Effect of Leakage Inductance)
PIVS	81 Volts	Output Rectifier Maximum Peak Inverse Voltage
PIVB	52 Volts	Bias Rectifier Maximum Peak Inverse Voltage



8 Performance Data

8.1 Efficiency

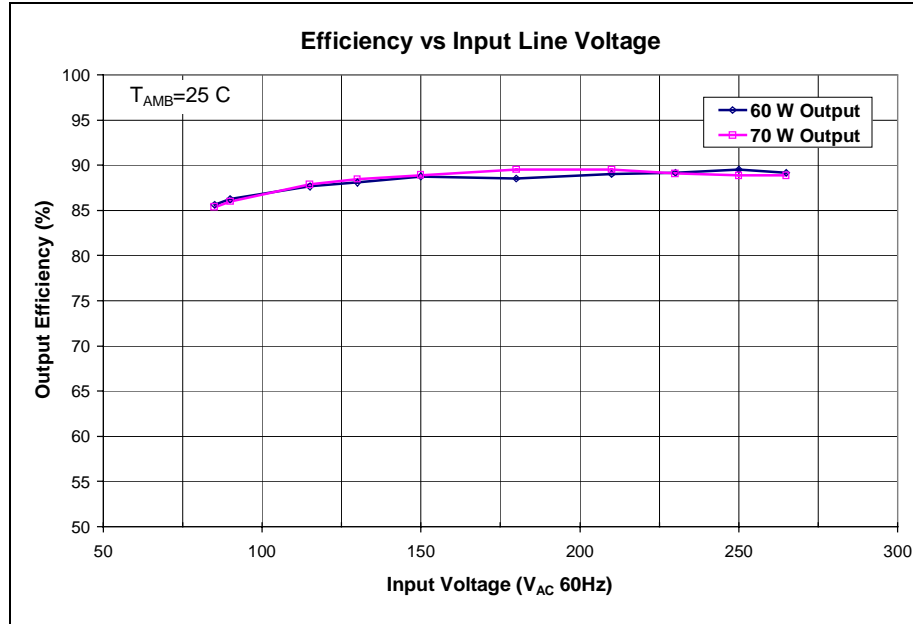

Figure 5 - Efficiency vs. Line Voltage

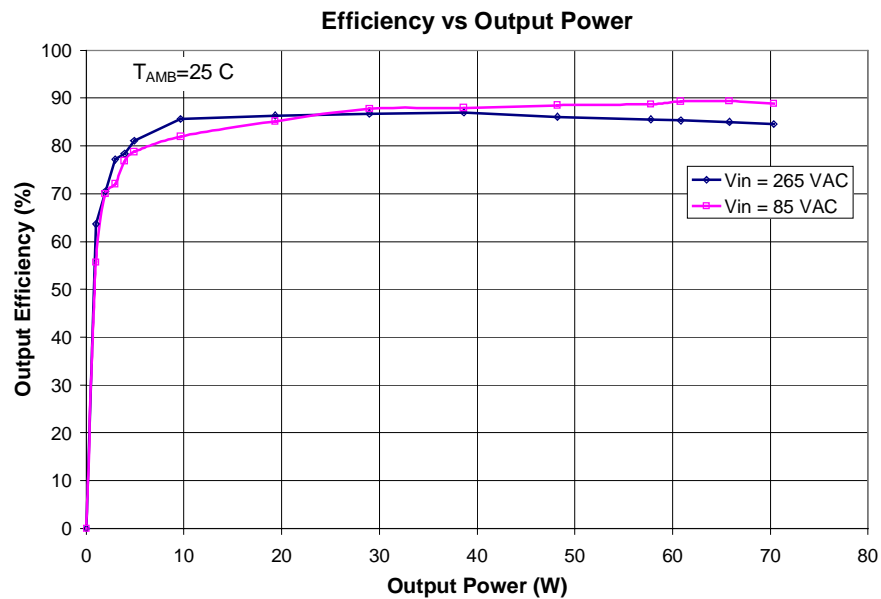

Figure 6 - Efficiency vs. Output Power (Min. and Max. Line Voltages 60 Hz)



8.2 No-load input power

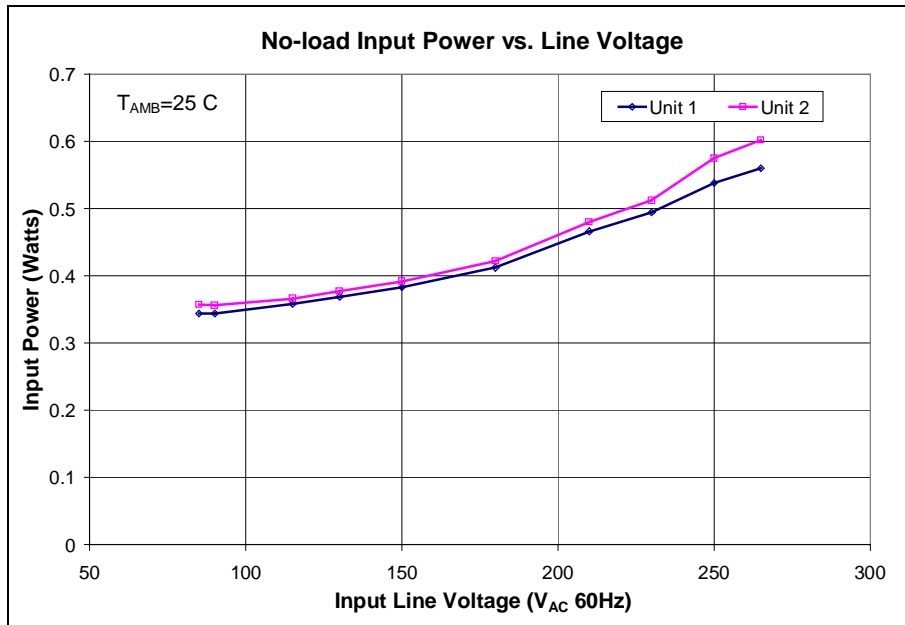

Figure 7 - No-load Input Power vs. Line Voltage

8.3 Regulation / Power Limiting

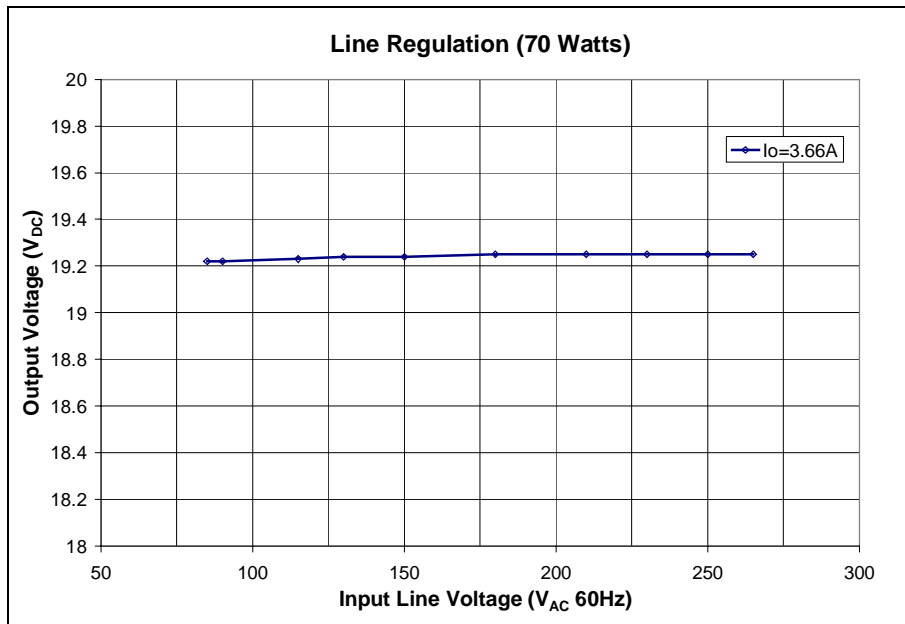

Figure 8 - Regulation vs. Input Voltage



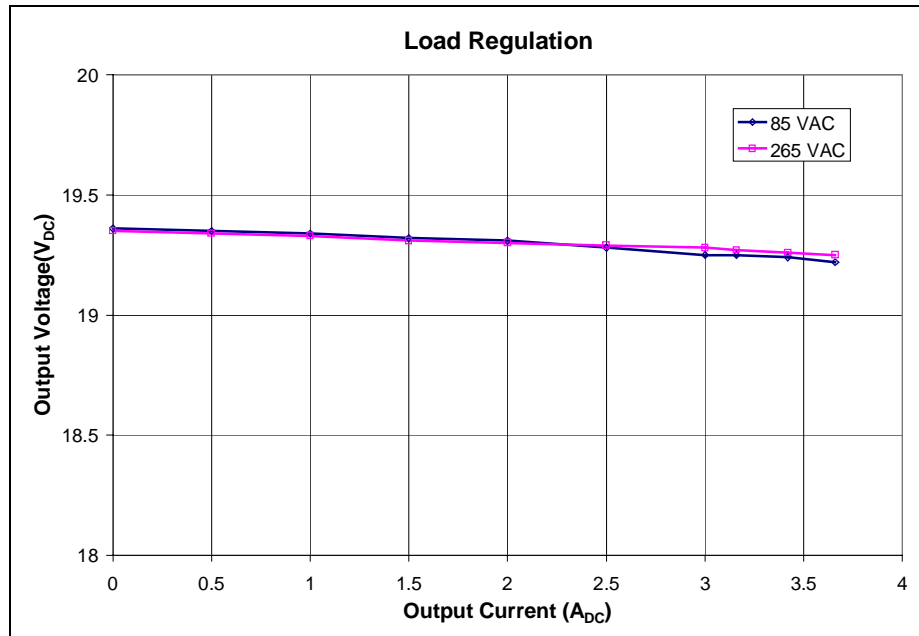

Figure 9 - Load Regulation

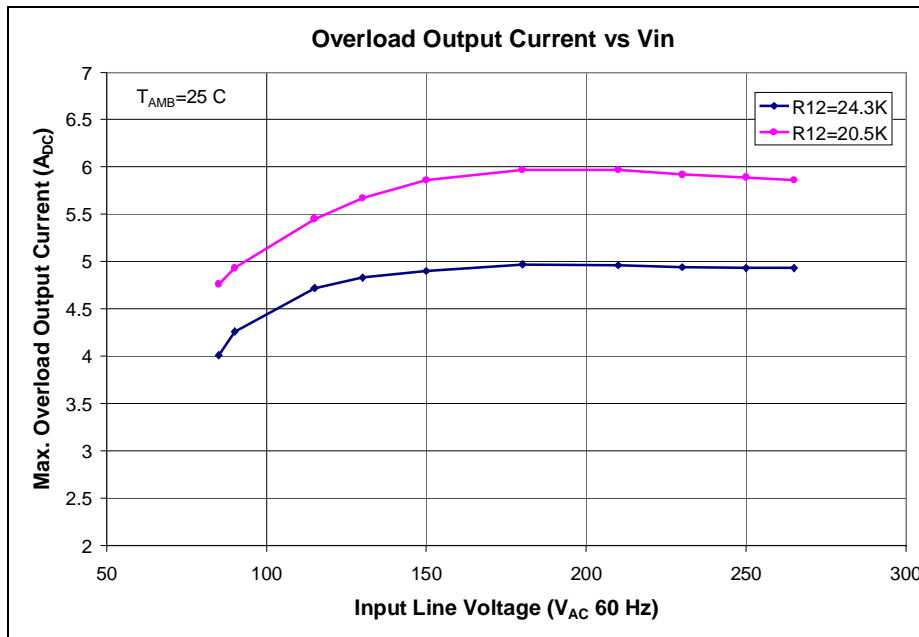

Figure 10 - Maximum Overload Current (auto-restart threshold) vs Line Voltage (2 values of R12)

Note: User can program resistor R12 to give desired overload characteristic.



9 Thermal Performance

The EP11 printed circuit board was designed to allow testing within the enclosure of a commercial laptop computer adapter. This adapter has an enclosure made of plastic and incorporates copper heat spreaders with a plastic shroud to insulate them from the board components. See Figure 12.

Thermal testing was done in still air. This was achieved by placing the board into a sealed cardboard box which is 11" long, 8.5" wide and 7" high. The adapter was placed on a 6" x 4" piece of single sided copper clad board (copper side down) which was taped to the bottom center of the box. The box had small openings for the thermal couple wires and the input and output cables. It was taped shut and placed in an environmental chamber. The measurements were made by attaching "T" type thermocouples to the following components using a thermally conductive glue (Loctite 384) with the wires dressed out of the enclosure in alignment with the output cable.

- | | | |
|----|-----------------|--|
| 1 | TOP249 tab: | The metal tab of the TO-220 package of the TOP249Y. |
| 2 | Bridge: | The junction of the plastic input rectifier bridge's package (BR1) and the copper heat sink HS1. |
| 3 | CM Choke: | The coil of the input choke L3. |
| 4 | Bulk / X cap: | The narrow space between C5 and C7. |
| 5 | Opto: | The top of the package of U2. |
| 6 | Enc. Top: | The outside of the enclosure centered on the top surface. |
| 7 | Enc. Side: | The outside of the enclosure on its side (near the fuse F1). |
| 8 | Snubber: | The package of the zener diode D2. |
| 9 | Transformer: | The top of the windings nearest the center. |
| 10 | Output Diode 1: | The metal tab of the rectifier D5. |
| 11 | Output Diode 2: | The metal tab of the rectifier D1. |
| 12 | Ambient 1: | This is suspended in the air approximately 3.5" above the center of the enclosure within the cardboard box. |
| 13 | Ambient 2: | This is suspended in the air approximately 1" above and 0.5" to the side of the enclosure about 1" from the input cable end. |



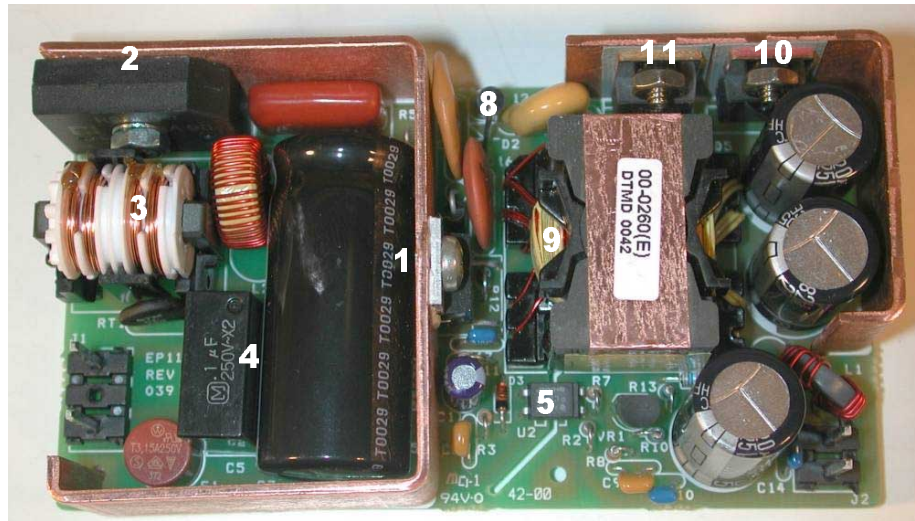

Figure 11 - Location of board mounted thermocouples

The tests were run at an input line voltage of 90 Volts (60Hz). The load was adjusted to provide a nominal output power at the end of a cable of first 60 Watts, then 65 Watts, 70 Watts, and finally 72.5 Watts. Power at the power supply output connector (J2) was approximately; 61.2 Watts, 66.2 Watts, 70.6 Watts and 73.8 Watts respectively.

The maximum case surface temperature was $< 75^{\circ}\text{C}$ in a 40°C ambient, 90 V_{AC}, 70W (see figure 14 for thermal image)



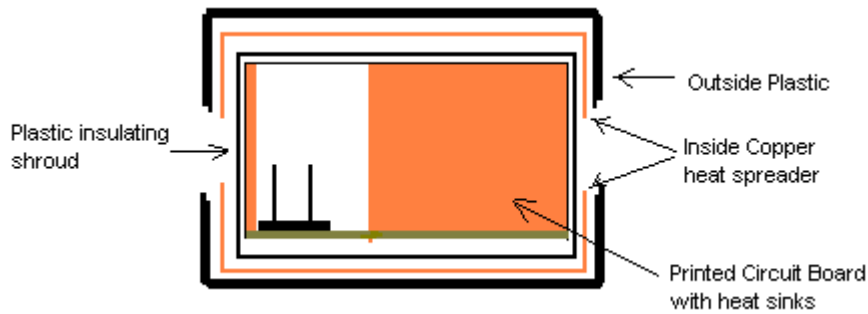

Figure 12 - Schematic cross-section of enclosure

Note: The diagram above shows an exploded view. In actual construction, there are no air gaps between the board, copper heat spreader and case. The main path for heat dissipation is via conduction therefore air gaps, even small, greatly increase the thermal impedance from the heatsinks to ambient. Air gaps will reduce power capability and increase the temperature of components.

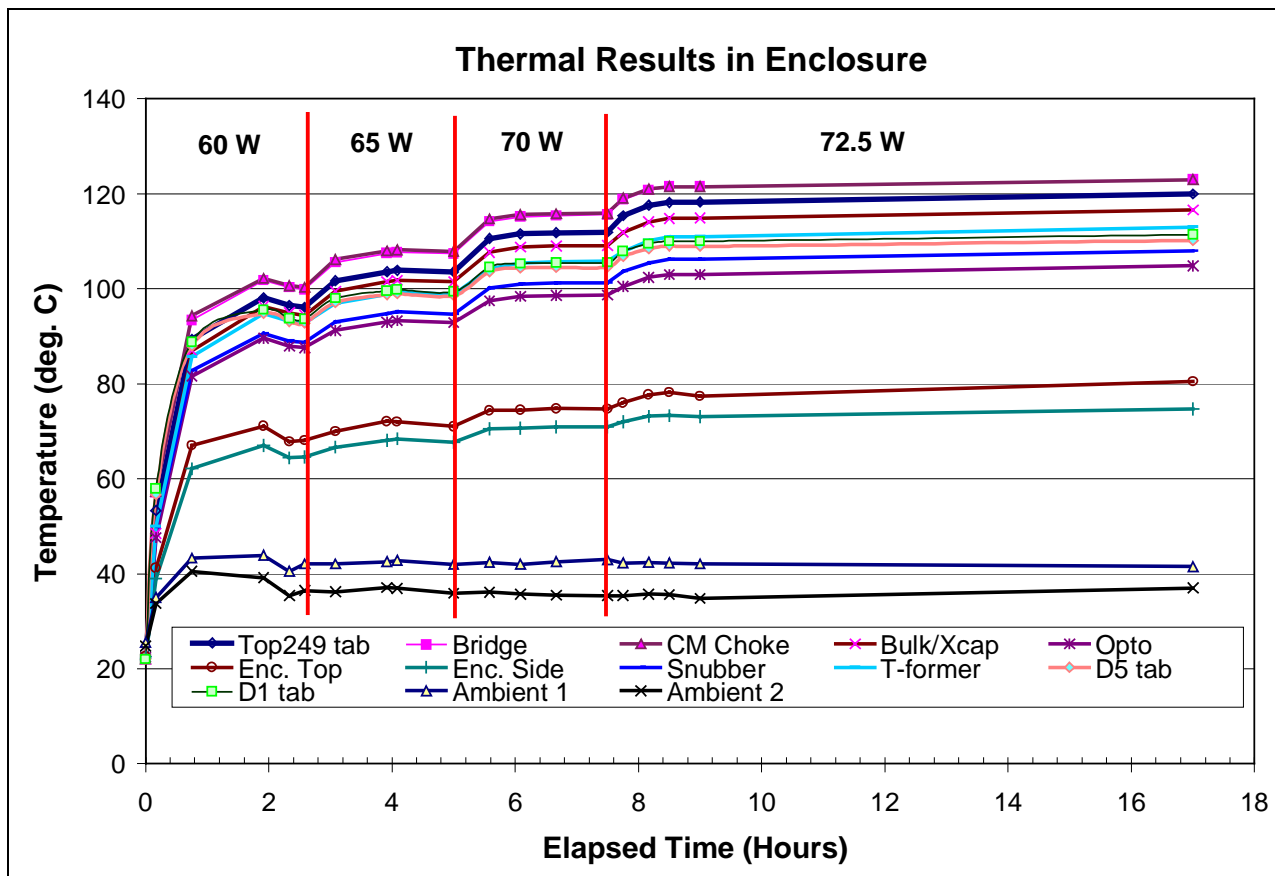

Figure 13 - Thermal results in enclosure at elevated ambient with 60, 65, 70, and 72.5 Watt loads – 90 V_{AC}

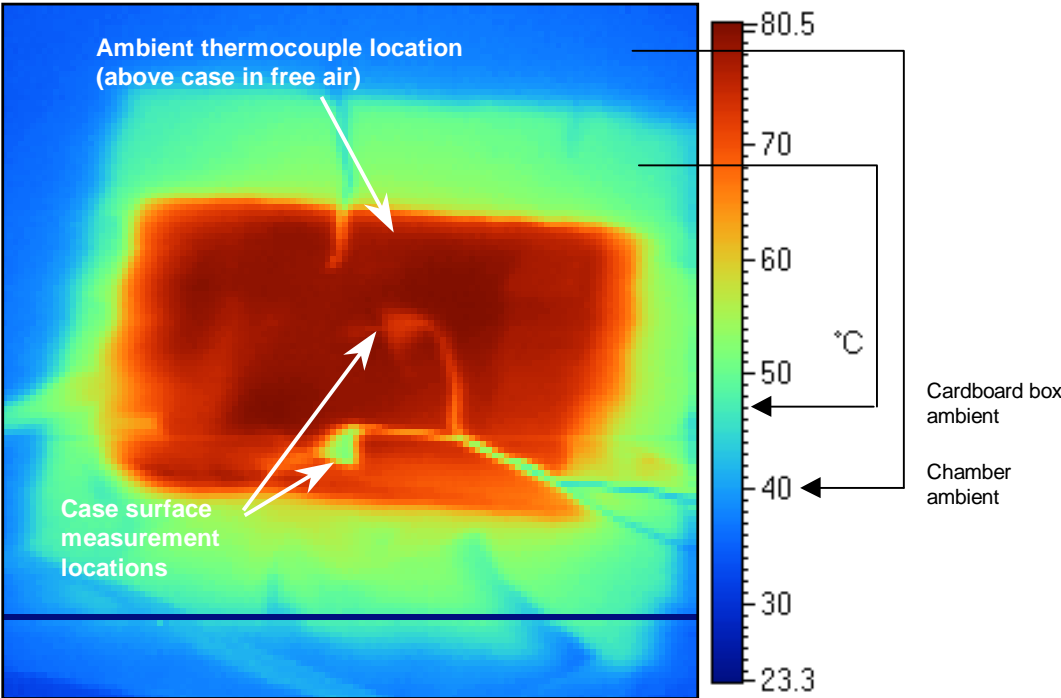

Figure 14 - Thermal image of case at 45°C ambient, 70 W output and 90 V_{AC} input
Measurement taken with unit inside a sealed cardboard box in environmental chamber, 8 second delay between opening door and box and taking thermal image looking into bottom of cardboard box.

10 Waveform Scope Plots

All scope plots were recorded with either a Yokogawa Model DL1540L or a Lecroy Model 9350AM, as noted.

10.1 Drain Voltage and Current During Normal Operation

Both waveforms were captured using a Yokogawa Oscilloscope. Upper trace is DRAIN voltage and lower trace is DRAIN current, timebase is 2 μ S/div.

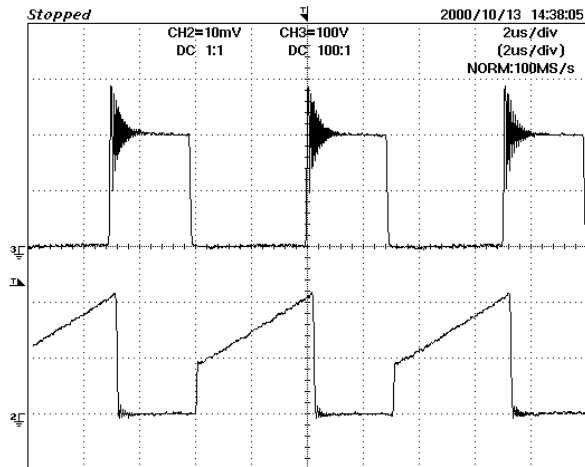

Figure 15 - V_{DRAIN} & I_{DRAIN} (100 V & 1 A /div) at 70 Watt load, 85VAC input. (2 μ s/div)

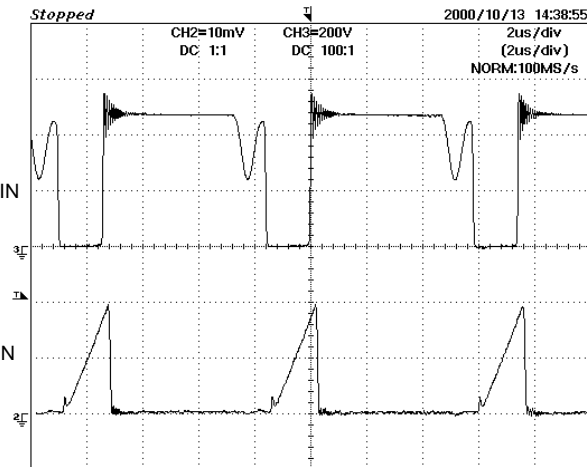

Figure 16 - V_{DRAIN} & I_{DRAIN} (100 V & 1 A /div) at 70 Watt load, 265VAC input. (2 μ s/div)



10.2 Output Voltage During Power-up

Both waveforms were captured using a Yokogawa Oscilloscope. Upper trace is V_{OUT} , the output voltage and the lower trace is V_{C7} , the voltage across the input capacitor (C7). Timebase is 50 ms/div.

In all cases the output voltage reaches regulation with no output overshoot. During operation at 85 V_{AC} the ripple present on the DC rail voltage can be clearly seen.

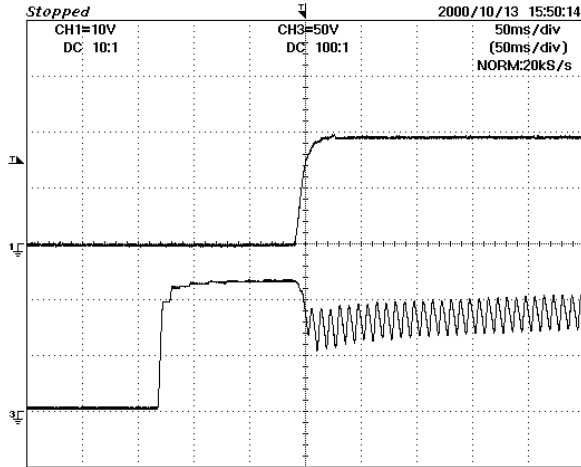

Figure 17 - Start-up, 5.25 Ω load, 85 V_{AC}
 V_{OUT} & V_{C7} (10 & 100 V/div, 50ms/div)

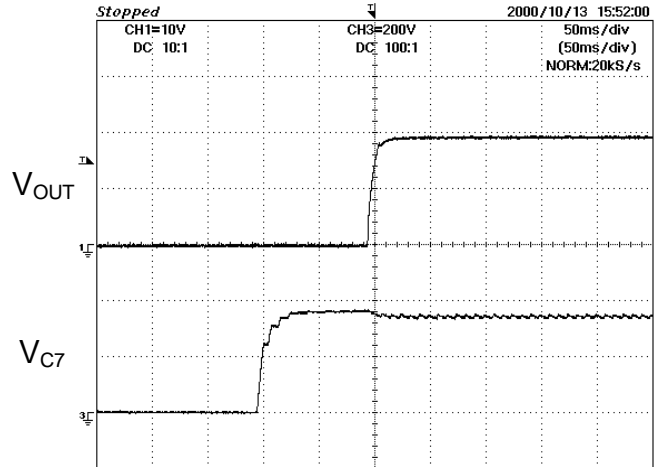

Figure 18 - Start-up, 5.25 Ω load, 265 V_{AC}
 V_{OUT} & V_{C7} (10 & 200 V/div, 50ms/div)

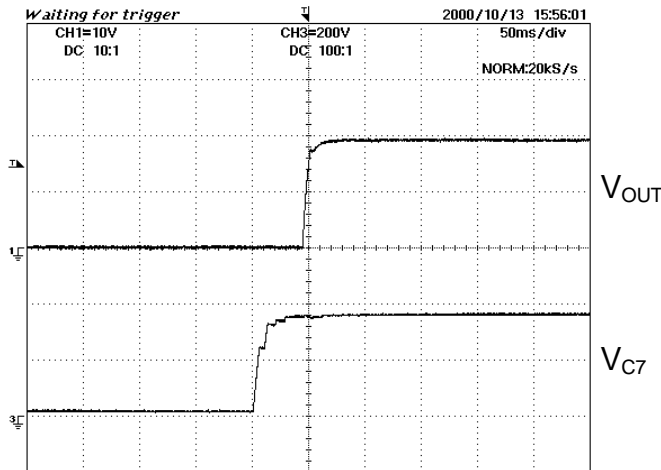

Figure 19 - Start-up, No load, 265 V_{AC}
 V_{OUT} & V_{C7} (10 & 100 V/div, 50ms/div)



10.3 Output Voltage During Power-down

Both waveforms were captured using a Yokogawa Oscilloscope. Upper trace is V_{OUT} , the output voltage and the lower trace is V_{C7} , the voltage across the input capacitor (C7). Timebase is 50 ms/div.

During power down the output voltage falls to zero with no ‘glitching’ due to line under voltage sensing.

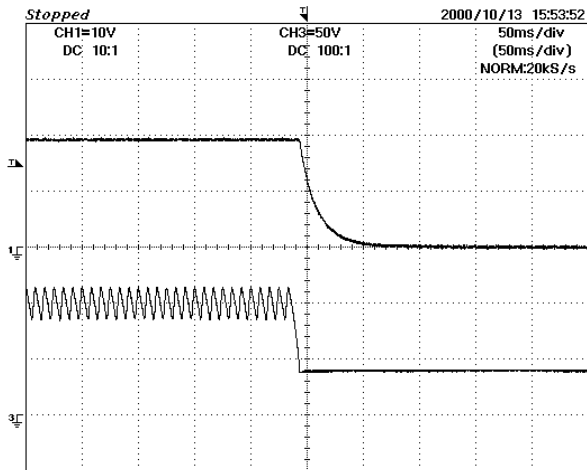

Figure 20 - Shut-down, 5.25 Ω load, 85 V_{AC}
 V_{OUT} & V_{C7} (10 & 100V/div,50ms/div)

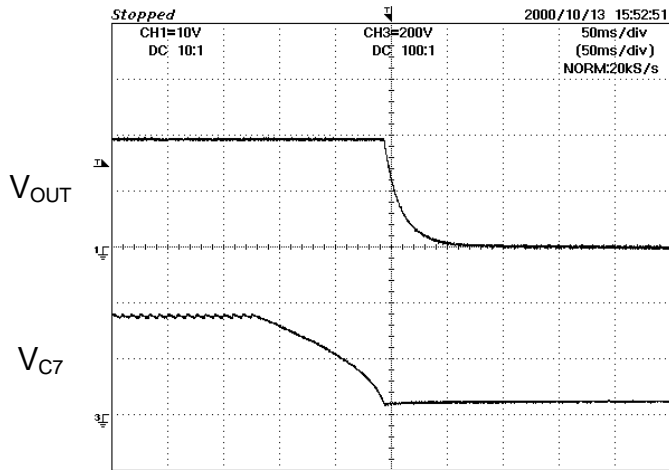

Figure 21 - Shut-down, No-load, 85 V_{AC}
 V_{OUT} & V_{C7} (10 & 100V/div,50ms/div)

10.4 Drain Voltage and Current during Power-Up (265 V_{AC})

The waveform was captured using a Yokogawa oscilloscope.

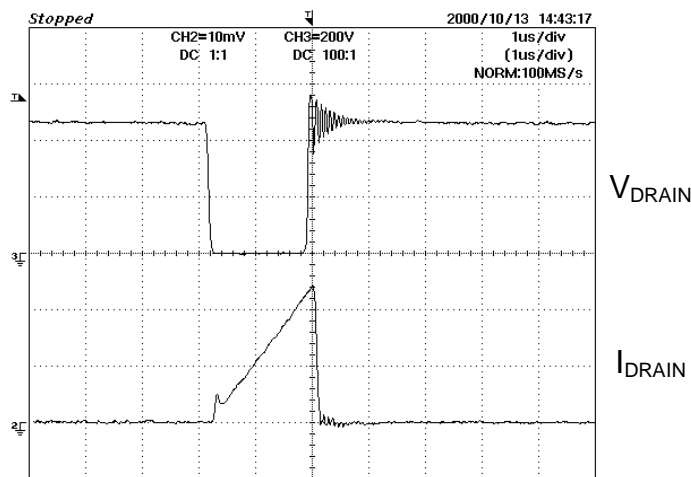

Figure 22 – Start-up, 5.25 Ω load, 265 V_{AC}
 V_{DRAIN} & I_{DRAIN} (200 V & 1 A/div, 1 μ s/div)

Peak DRAIN voltage is acceptable at < 600 V, well below the recommended maximum of 650 Vpk. DRAIN current waveform shows no sign of core saturation.



10.5 DRAIN Current During Power-Up and Power-Down

The waveforms were captured using a Lecroy oscilloscope. Upper trace is V_{C7} , the voltage across the input bulk capacitor (C7) and the lower trace is I_{DRAIN} , the current through the DRAIN pin. Timebase is 50 ms/div.

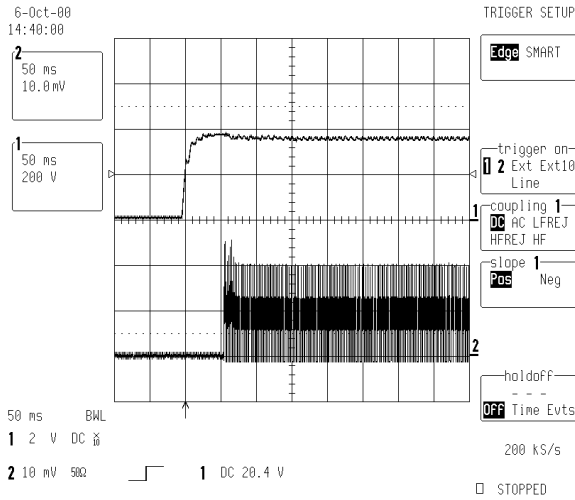

Figure 23 - Start-up, 5.25 Ω load, 265 V_{AC}
 V_{C7} & I_{DRAIN} (200 V & 1A/div, 50ms/div)

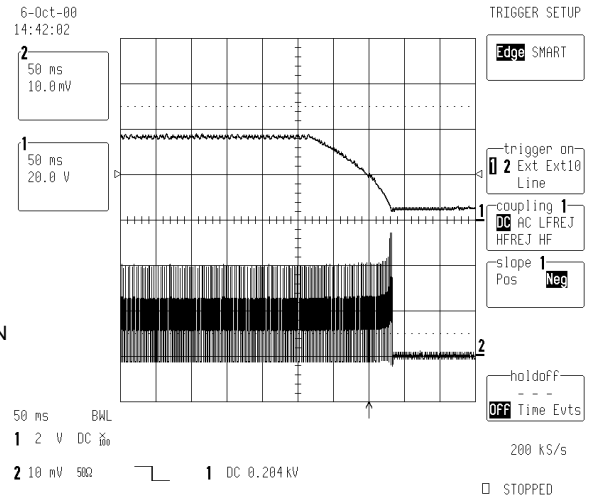

Figure 24 - Shut-down, 5.25 Ω load, 265 V_{AC}
 V_{C7} & I_{DRAIN} (200 V & 1A/div, 50ms/div)

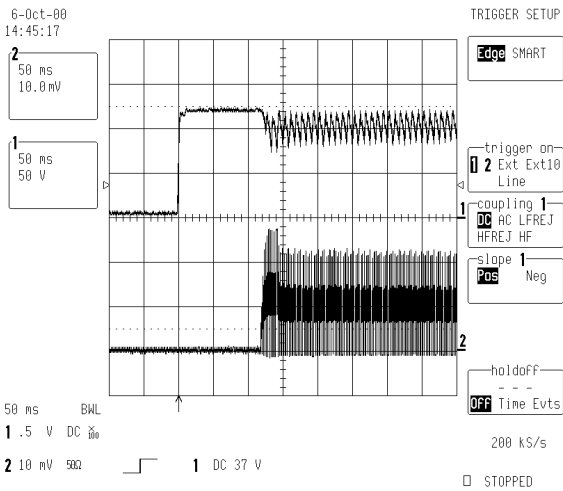

Figure 25 - Start-up, 5.25 Ω load, 85 V_{AC}
 V_{C7} & I_{DRAIN} (50 V & 1A/div, 50ms/div)

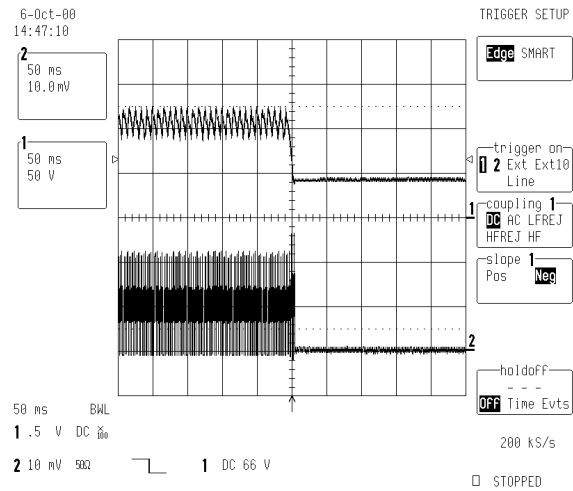

Figure 26 - Shut-down, 5.25 Ω load, 85 V_{AC}
 V_{C7} & I_{DRAIN} (50 V & 1A/div, 50ms/div)



10.6 Load Transient response (15 to 100% load change)

10.6.1 15 to 100% load change, 85 V_{AC}

The waveforms were captured using a Yokogawa oscilloscope. Upper trace is V_{OUT_AC}, the output voltage AC coupled and the lower trace is I_{OUT}, the output current. Timebase is 5 ms/div.

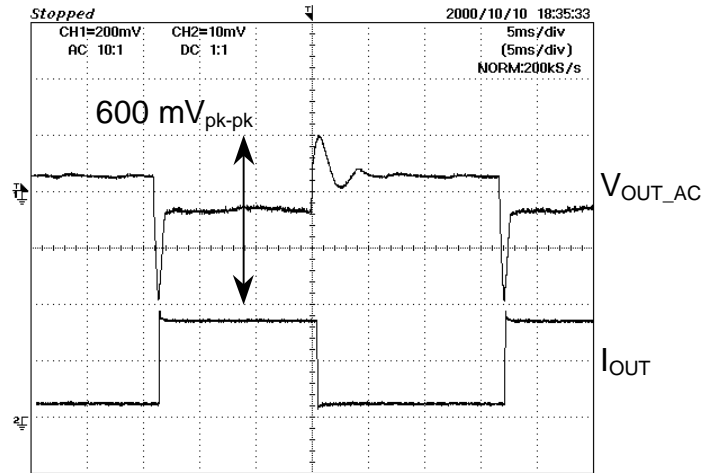

Figure 27 - Transient Response 85 V_{AC} 50 Hz, I_{OUT}: 3.66A to 0.5A
V_{OUT} & I_{OUT} (200 mV & 2A/div, 5ms/div)



10.7 Load Transient response (0 to 50% load change)

The 0 to 50% load variation shows no appreciable degradation in ripple response due to operation at a lower switching frequency at zero load (see bode response plots also).

The waveforms were captured using a Lecroy oscilloscope. Upper trace is V_{OUT_AC} , the output voltage AC coupled, 200 mV/div. Timebase is 5 ms/div.

10.7.1 0 to 50% load change, 85 V_{AC}

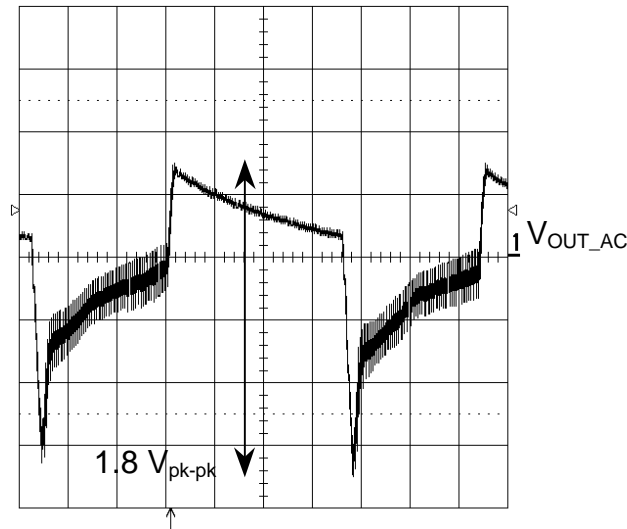

Figure 28 - Transient Response 85 V_{AC} 50 Hz, I_{OUT}: 0 A to 1.83 A
V_{OUT} (200 mV, 5ms/div)

10.7.2 0 to 50% load change, 130 V_{AC}

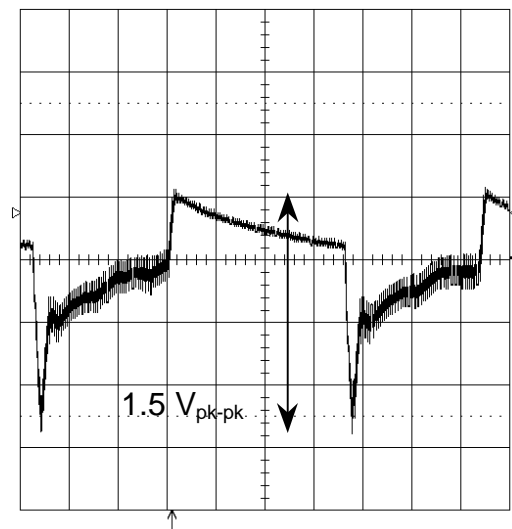

Figure 29 - Transient Response 130 V_{AC} 50 Hz, I_{OUT}: 0 A to 1.83 A
V_{OUT} (200 mV, 5ms/div)



10.7.3 0 to 50% load change, 130 V_{AC}

Figure 30 - Transient Response 265 V_{AC} 50 Hz, I_{OUT}: 0 A to 1.83 A
V_{OUT} (200 mV, 5ms/div)

10.8 Ripple Measurements

10.8.1 DC Ripple Measurement Technique

Details of output ripple probe are provided below. Decoupling capacitors are included to minimize the effects of high frequency probe coupling and ensure a consistent measurement set-up.

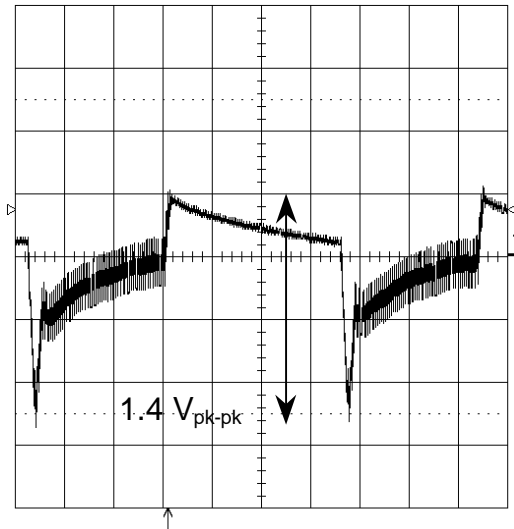
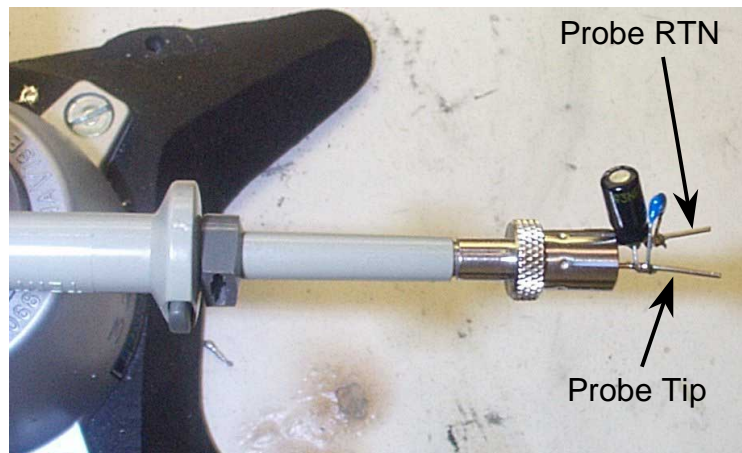

Figure 31 - Tektronix P6105A Oscilloscope Probe with Probe Master 5125BA BNC adapter, modified with wires for Probe Ground for ripple measurement. Two parallel decoupling capacitors have been added (1.0 μ F/50 V aluminium electrolytic and a 0.1 μ F/50 V ceramic)

10.8.2 Ripple Measurement Results

The results below show very good ripple results (<0.25%) even with a small input capacitor (2.1 $\mu\text{F}/\text{W}$). This is due to the line feed forward function implemented via the L pin, R14 and R15.

The waveforms were captured using a Yokogawa oscilloscope. Trace is $V_{\text{OUT_AC}}$, the output voltage AC coupled into the 'scope input at 20 mV per division. Timebase is 5 ms/div.

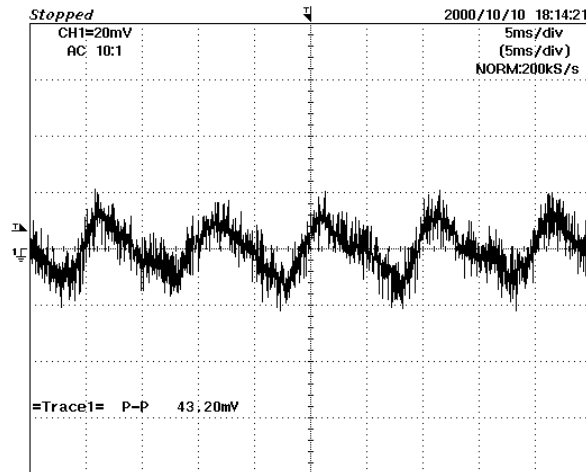

Figure 32 - Output ripple 85 V_{AC} 50Hz, $I_{\text{OUT}}=3.6$ A
 V_{RIPPLE} (20 mV / div, 5 ms / div)



11 Control Loop Characteristics

The control loop characteristics were measured with a Venable measurement system, which breaks the control loop between the emitter of the opto-isolator (U2) and the control pin of the TOP249Y (U1) and its associated components; C11, R11, and C17. The results are tabulated below, followed by graphs of the last five table entries:

Result #	V _{IN} (V _{AC})	I _{OUT} (A _{DC})	Crossover Freq.	Phase Margin
1	130	3.16	1000 Hz	53 deg.
2	85	3.16	1220 Hz	55 deg.
3	85	0.71	435 Hz	45 deg.
4	265	0.70	556 Hz	50 deg.
5	265	3.16	1000 Hz	50 deg.
6	85	1.0	800 Hz	52 deg.
7	85	3.66	1600 Hz	62 deg.
8	265	3.66	1000 Hz	56 deg.
9	265	0	530 Hz	95 deg.
10	115	1.0	380 Hz	45 deg.
11	115	0	500 Hz	120 deg.

Note results for 9, 10 and 11 are shown without adding a 180 deg offset for the secondary error amplifier. Therefore phase margin is referenced to -180 deg.

Measurements were made at zero load to confirm stability during the lower switching frequency operation at no-load.



Table 2 - Summary of Gain/Phase Measurements

11.1 Gain Phase Results

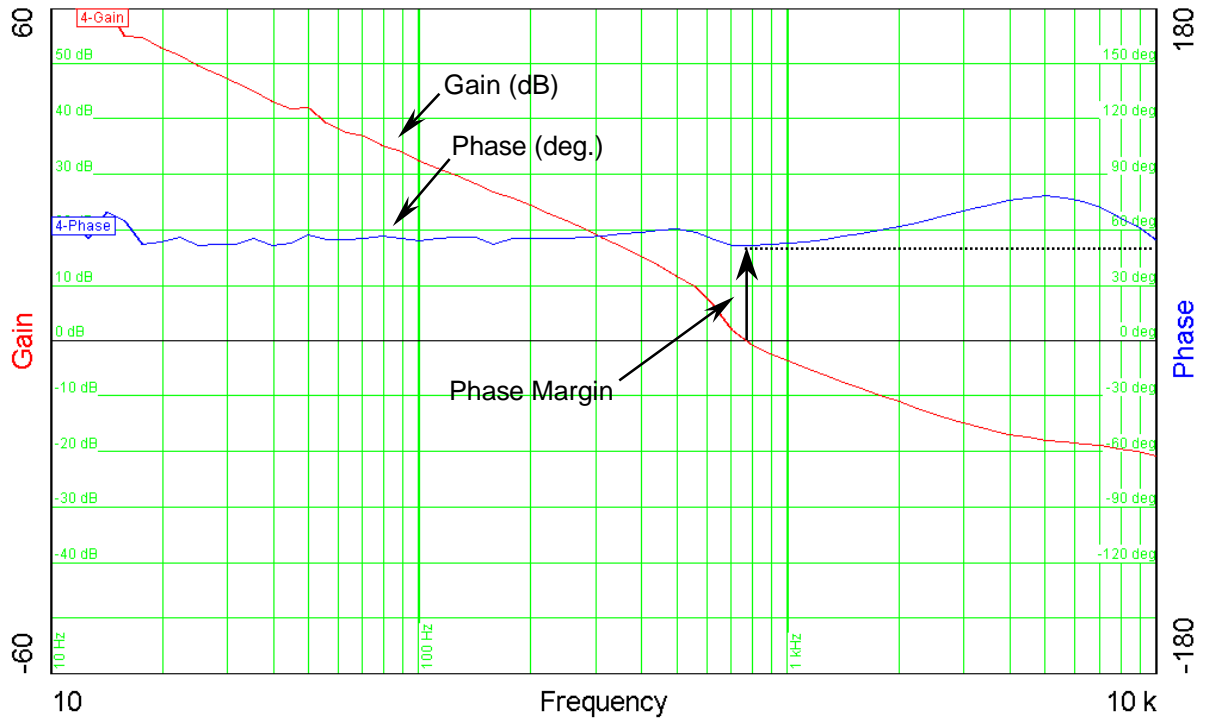

Figure 33 - Gain Phase Plot 6: V_{IN} : 85 V_{AC}, I_{OUT} : 1 A, Crossover=800 Hz, Phase Margin=52°



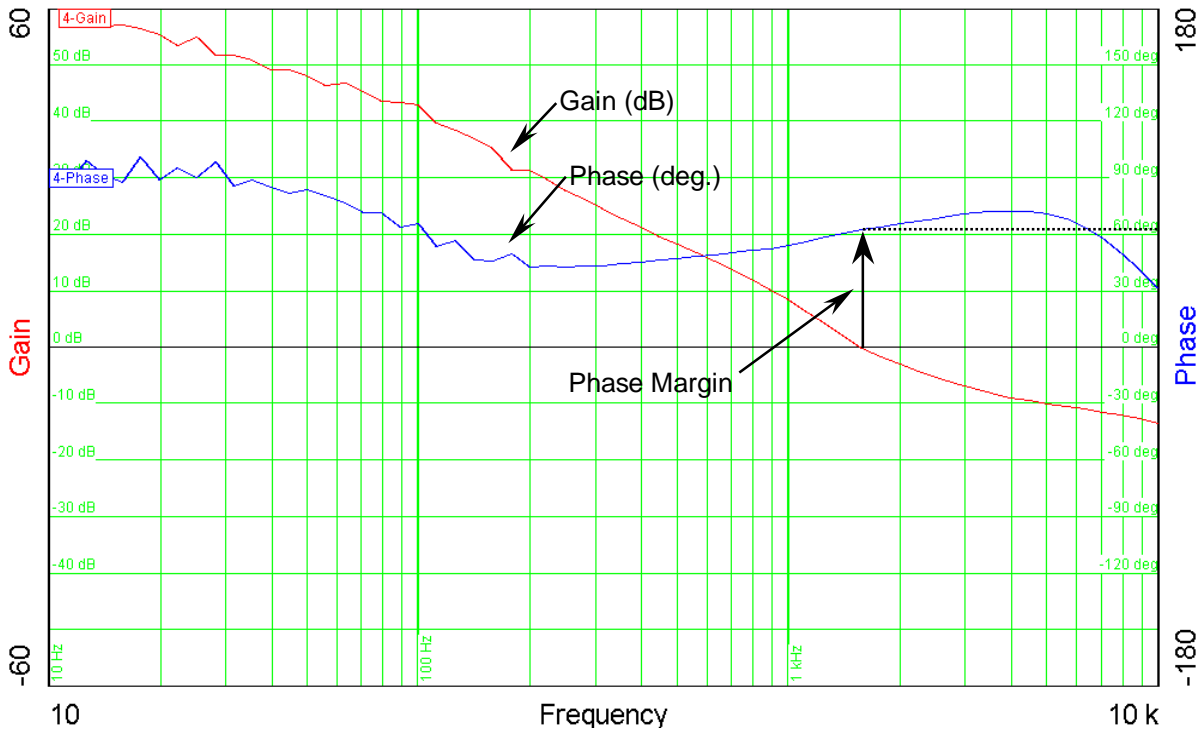

Figure 34 - Gain Phase Plot 7: V_{IN} : 85 V_{AC}, I_{OUT} : 3.66 A, Crossover=1.6 kHz, Phase Margin=62°

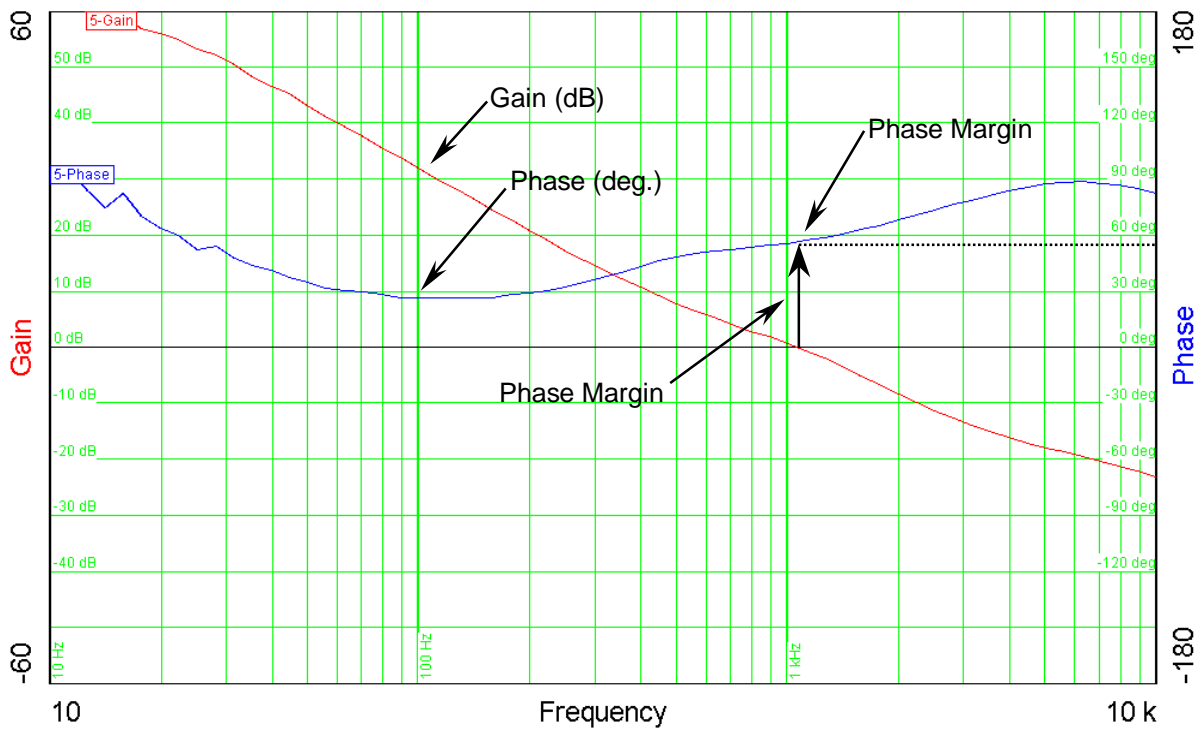

Figure 35 - Gain Phase Plot 8: V_{IN} : 265 V_{AC}, I_{OUT} : 3.66 A, Crossover=1 kHz, Phase Margin=56°



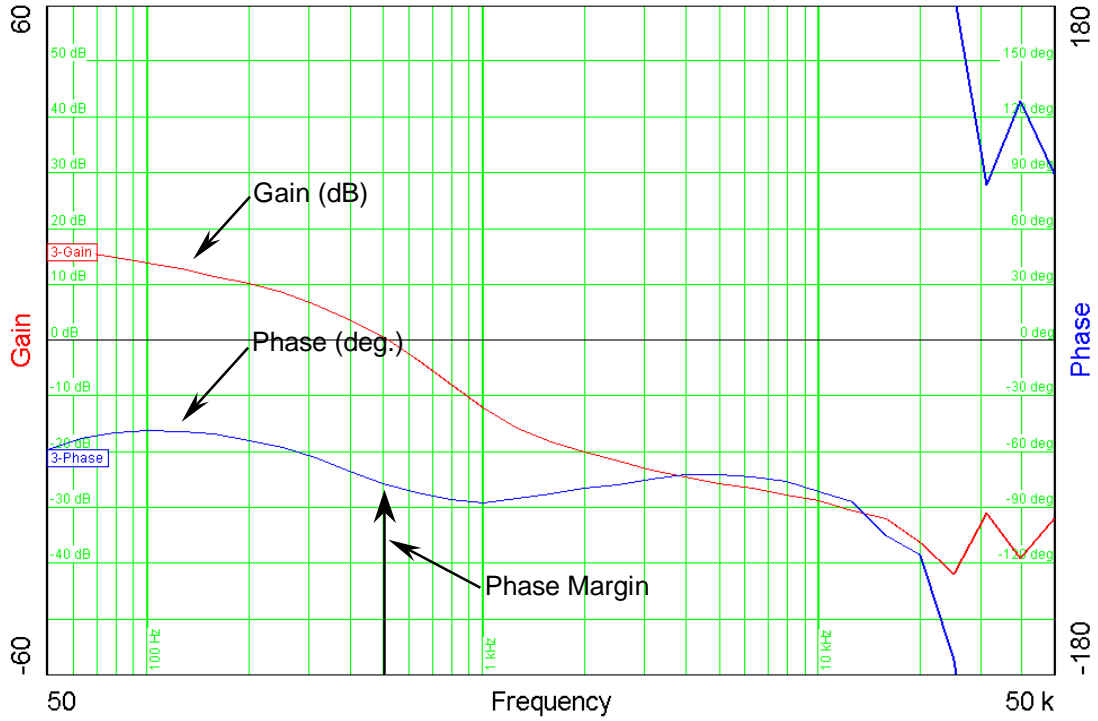

Figure 36 - Gain Phase Plot 9: V_{IN} : 265 V_{AC}, I_{OUT} : 0 A, Crossover=530 Hz, Phase Margin=95°

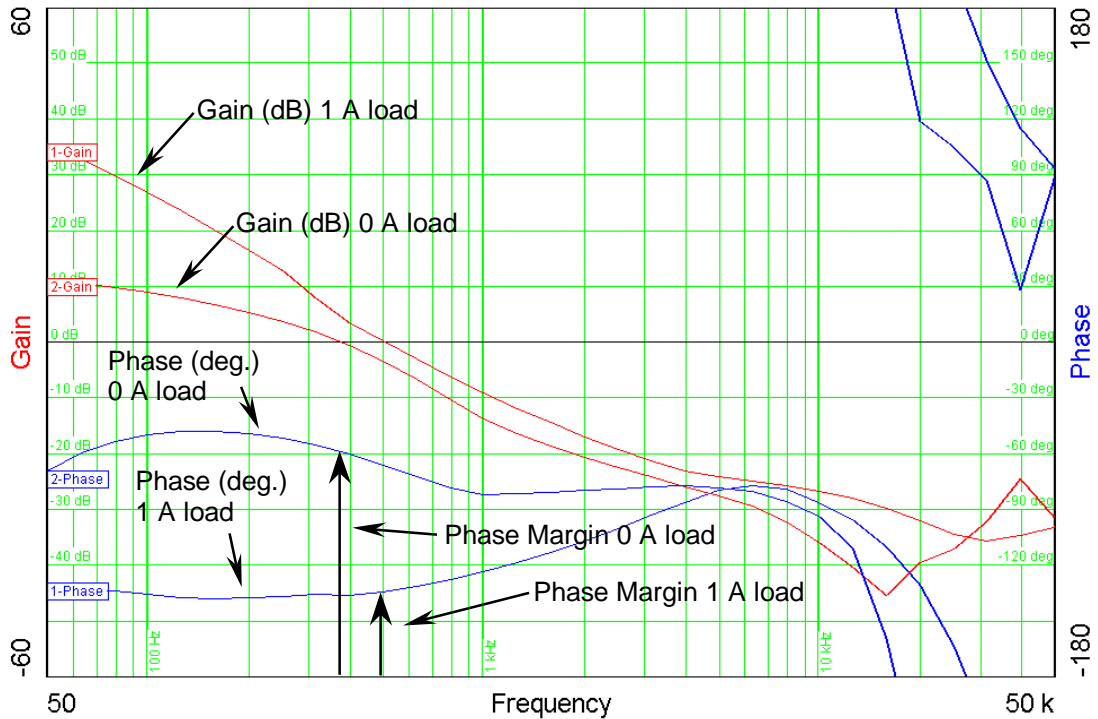

Figure 37 - Gain Phase Plot 10/11: V_{IN} : 115 V_{AC}, I_{OUT} : 1A & 0 A, Crossover=380 & 500 Hz, Phase Margin=45° & 120°



12 Conducted EMI Scans

The attached plots show EMI performance for the EP11 as compared to the CISPR22B conducted emissions limits. Both input AC lines were essentially identical. This worst case scan was taken with an input of 230VAC and a 70W resistive load. The output return was connected to the LISN's artificial hand connection to simulate a worst case condition.

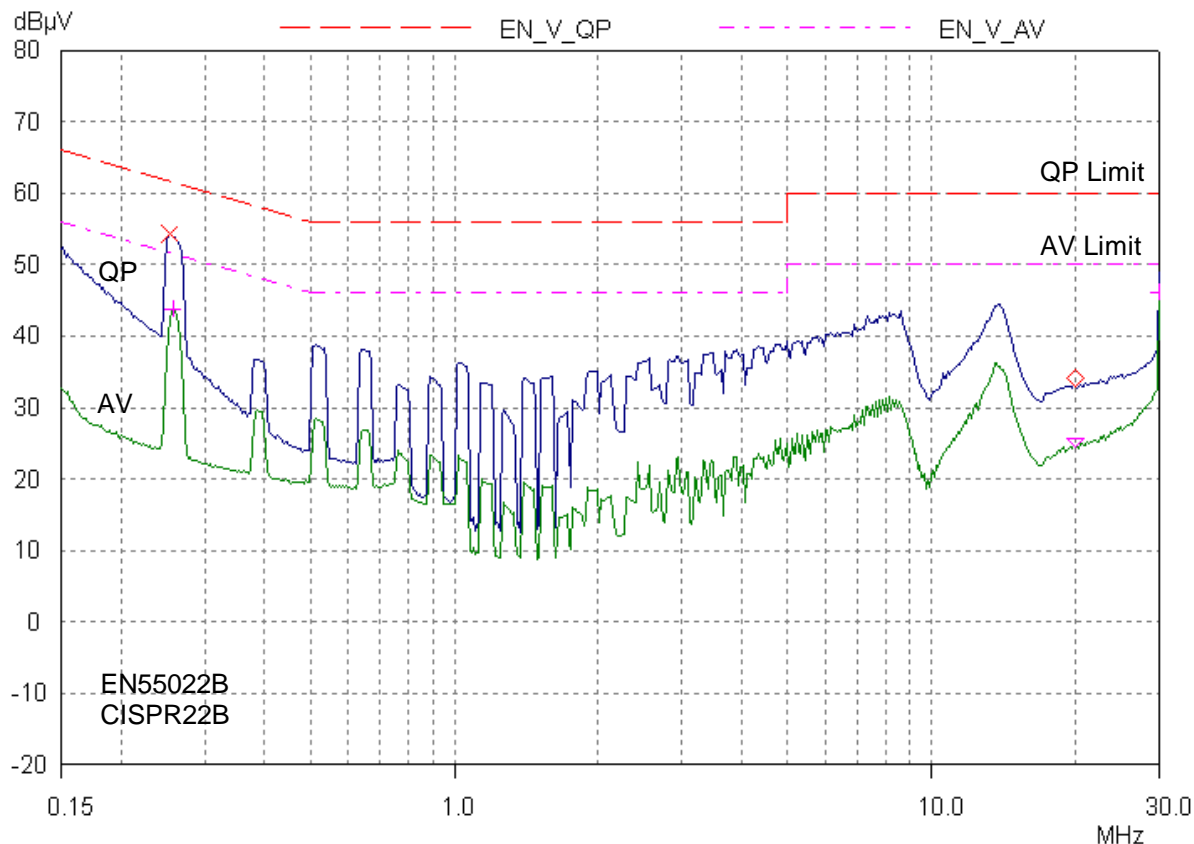

Figure 38 – Highest Measured Conducted Emissions Scan (230 V_{AC}, 70 W, with artificial hand)

Note: EMI measurements without artificial hand grounding will be significantly lower than shown above.



13 Appendix A - Thermal considerations:

The *TOPSwitch-GX* family significantly extends the power capability over the *TOPSwitch-II* family of devices. The higher power capability is a result of a lower internal high voltage MOSFET $R_{DS(ON)}$ over that of any previous *TOPSwitch-II*. This lower $R_{DS(ON)}$ enables compact high power adapters such as the EP11.

The output powers of higher power adapter supplies like EP11 are all thermally limited to some degree. One of the important design considerations is often compact size which together with efficiency limitations combine to limit the maximum continuous power of the design. This adapter is no exception. The maximum continuous power is rated at 70 Watts in an enclosure at a 40 °C ambient temperature (see Figure 13). This rating is very “packaging” dependent.

The power dissipated by the high voltage MOSFET within the TOP249Y is a significant source of heat. Together with the heat generated in the transformer, output diodes, input rectifier and filter, as well as the output filter must be managed to keep the maximum component temperatures within limits. Layout and heat sinking and the complete package must be designed to manage the heat generated by the board components.

Adapters are generally completely enclosed external power sources that provide little or no ventilation for the internal converter components. They are also generally small in size which creates high power densities and necessitates very tight packaging of components. The first and most fundamental performance element to optimise for a successful high power adapter is its efficiency. Other key considerations include; heat sink design, “hot spots”, and maximum component temperatures.



13.1 Efficiency:

Items to consider for maximising efficiency:

- Transformer:
 - Minimise leakage inductance and conduction losses
 - Use highest possible duty factor and operate in continuous mode for reduced peak currents (the copper window of the transformer bobbin may limit this)

- Output Diodes:
 - Use low forward drop, higher current rated diodes
 - Use Schottky-barrier diodes when possible
 - Parallel diodes to reduce forward drop. Take care to make sure that paralleled diodes share current equally (the EP11 uses dual secondary windings and a common heat sink to achieve this).
 - Allow diodes to run as hot as possible (consistent with maximum board temperature and component life constraints). This will minimize the forward drop.

- Power Switch (*TOPSwitch-GX*):
 - Use a lower $R_{DS(ON)}$ part (the TOP249 used in the EP11 is capable of over 250 Watts in an open frame design)
 - Use the highest possible maximum operating duty cycle to reduce conduction losses (this must be balanced against increased leakage and transformer losses).

- Line Filter:
 - Use as few turns as possible for inductor windings
 - Increase capacitor value (rather than inductor value) where practical, to minimize differential choke size down.

13.2 Heat Sinking:

Heat sinking power devices such as the *TOPSwitch-GX*, input diodes, and output diodes will be more critical in an adapter application than in open frame designs. This is largely because all of the generated heat must be **CONDUCTED** through the enclosure walls. The heat sinks used in EP11 are made of copper. Copper has high thermal conductivity ($\sim 3.94 \text{ W/cm } ^\circ\text{C}$), but it is heavy. Aluminum may be used instead. It is lighter, but it has somewhat lower thermal conductivity ($\sim 2.18 \text{ W/cm } ^\circ\text{C}$). The net thermal conductivity from the heat generating components to the outside air of the adapter's enclosure together with the overall efficiency of the supply determines the maximum continuous power output for a given environment.



13.3 Heat Spreading and Enclosure Surface Temperature:

The enclosures of adapters are generally limited to an absolute maximum external surface temperature (defined by safety approval agencies such as U.L.). For higher power adapters, it is often necessary to use an internal heat spreader to evenly distribute the internally generated heat across the inside of the enclosure's outside walls. This will help eliminate "hot spots". The "heat spreader" is generally nothing more than an additional foil wrap (or sheets of copper or aluminum) between the converter and the outside enclosure walls. The caveat is that these heat spreaders must generally be electrically insulated from the heat sinks to provide safety isolation. This electrical insulation invariably contributes significant thermal impedance. Even with heat spreaders, care must be taken to avoid crowding the heat generating components together more than is necessary.

13.4 Component Temperature:

The maximum operating temperature of the power devices within the converter may be limited by various considerations depending on the type of component.

- TOPSwitch-GX :

The *TOPSwitch-GX* is thermally protected by its internal thermal shutdown feature. This feature prohibits the device from operation when the internal junction temperature (T_J) exceeds 140 °C (typ.). This junction temperature will be higher than the package tab temperature (T_C) depending on the amount of power being dissipated. It is good design practice to keep this junction temperature below 120°C to guarantee continuous operation with adequate margin. For the EP11, thermal shutdown occurs at a TOP249 tab temperature (T_C) of approximately 120°C (depending somewhat on the output power level). At 65 Watts output, the EP11's TOP249 tab stabilises at $T_C=103.6$ °C in an ambient of approximately 40°C (while in the enclosure with a 90VAC input). At 70Watts this tab temperature stabilises at $T_C=111.9$ °C. Care must be taken with any package design to make sure that adequate margin remains at the maximum output power and ambient temperature. One way to test this is to stabilise the supply at maximum power in the desired environment and subsequently increase either the power or the ambient temperature in small increments (waiting for the internal temperatures to stabilise each time) until shutdown occurs. This allows the designer to determine how much margin there is for thermal shutdown.



- Input and Output Diodes:

For the power diodes the maximum junction temperature is generally 150°C. Depending on the required product life expectancy and the maximum lead temperature of the PC board material chosen, the actual allowed maximum junction temperature (T_J) may be significantly less. Also the junction temperature (T_J) will be significantly higher than the tab temperature (T_C) and must be computed from the measured tab temperature and the estimated power dissipation in the device using the thermal impedance junction to case (θ_{JC}) of the device given in its data sheet.

- Magnetic Components:

If the transformer and the other magnetic components use 130 °C magnet wire in their construction, then the maximum hot spot temperature is limited to 105 °C. Higher operating temperatures are possible with higher temperature rated wire. Generally, however, the ferrite core temperatures should be limited to near 100 °C to maintain the saturation flux density.

13.5 Conclusion:

Careful design and rigorous testing are required to ensure that a design will perform adequately under high load and high temperature conditions.



14 Appendix B - Custom Component Documentation:

14.1 Toroid Filter Inductor (L2):



ELECTRICAL SPECIFICATIONS:

Inductance	Measured at 100KHz	70.0 μ H min.
------------	--------------------	-------------------

MATERIALS:

Item	Description
[1]	Core: Powder Iron Toroid, Micrometals T50-26 or equivalent Epoxy coated
[2]	Magnet Wire: #25 AWG Solderable Double coated

COIL WINDING INSTRUCTION:

Use item [2]. Wind 48 turns; spread evenly around circumference of the core as illustrated below.

ILLUSTRATION:

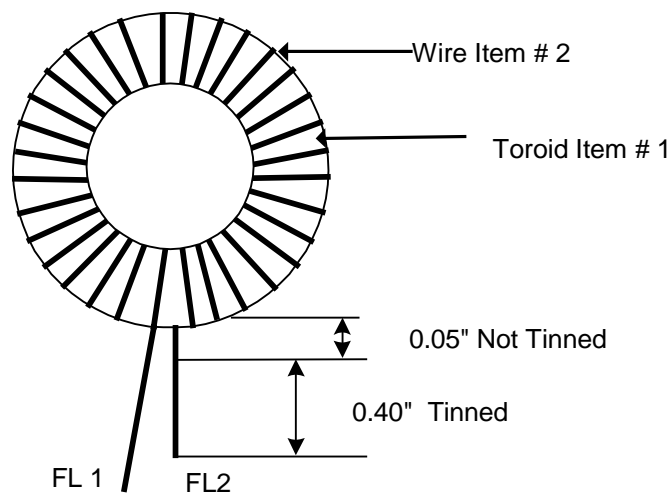

14.2 Output Inductor (L1)

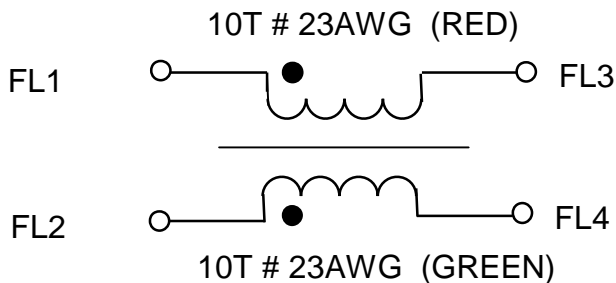

ELECTRICAL SPECIFICATIONS:

Inductance(LCM)	Pin1-3 or 2-4 Measure at 100KHz	200 uH min.
Inductance (LL)	1-2 with pin 3-4 shorted Measure at 100KHz	1.6 uH (ref.)

MATERIALS:

Item	Description
[1]	Core: Ferrite Torrid TDK T10 x2.5 x5 Material H5B2 Epoxy coated
[2]	Magnet Wire: # 23 AWG Solderable Double coated (RED)
[3]	Magnet Wire: # 23 AWG Solderable Double coated (GREEN)

COIL WINDING INSTRUCTION:

Start at pin FL1 wind 10 turns (Item #2) on one half of Toroid. End at pin FL3 ,
 Start at pin FL2 wind 10 turns (Item #3) in the same direction on other half of
 Toroid. End at pin FL4.
 Spread the wire evenly around each half of the core circumference,
 as illustrated below.

ILLUSTRATION:

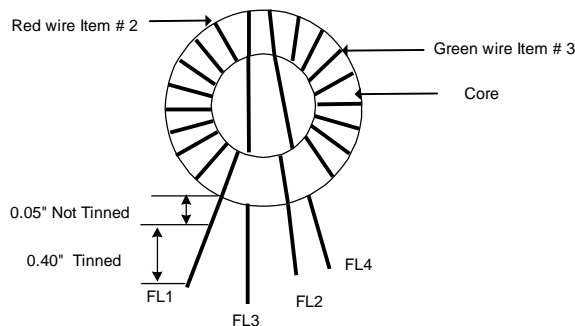

14.3 Heat sink #1 (TOPSwitch-GX and Input Bridge)

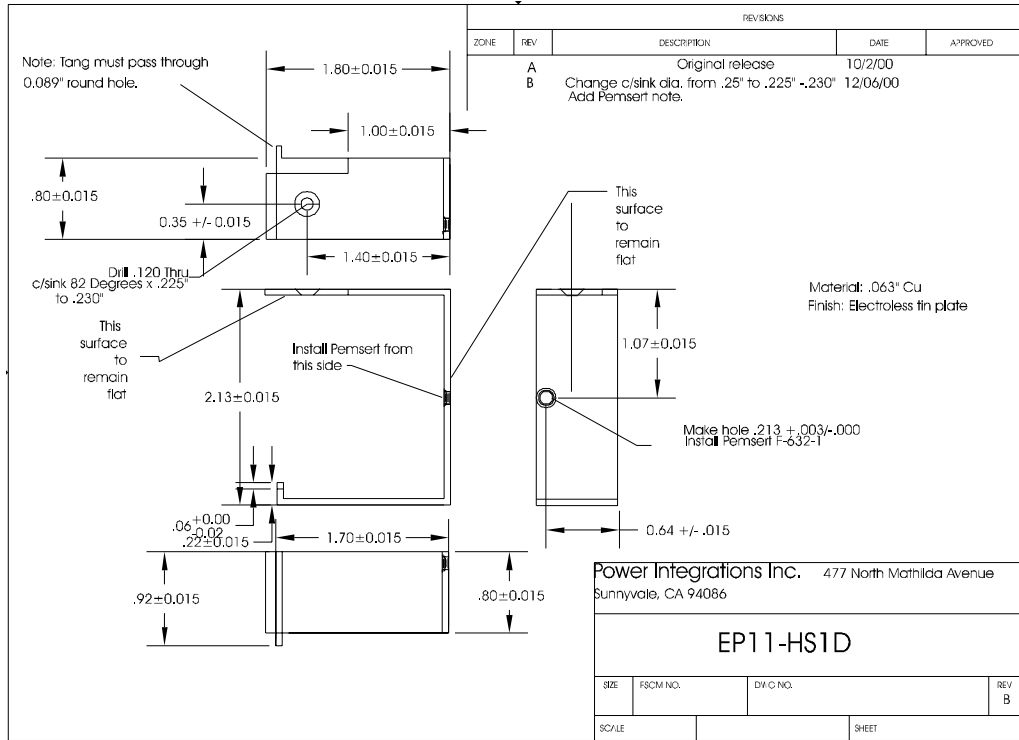

14.4 Heat sink #2 (Output Diodes)

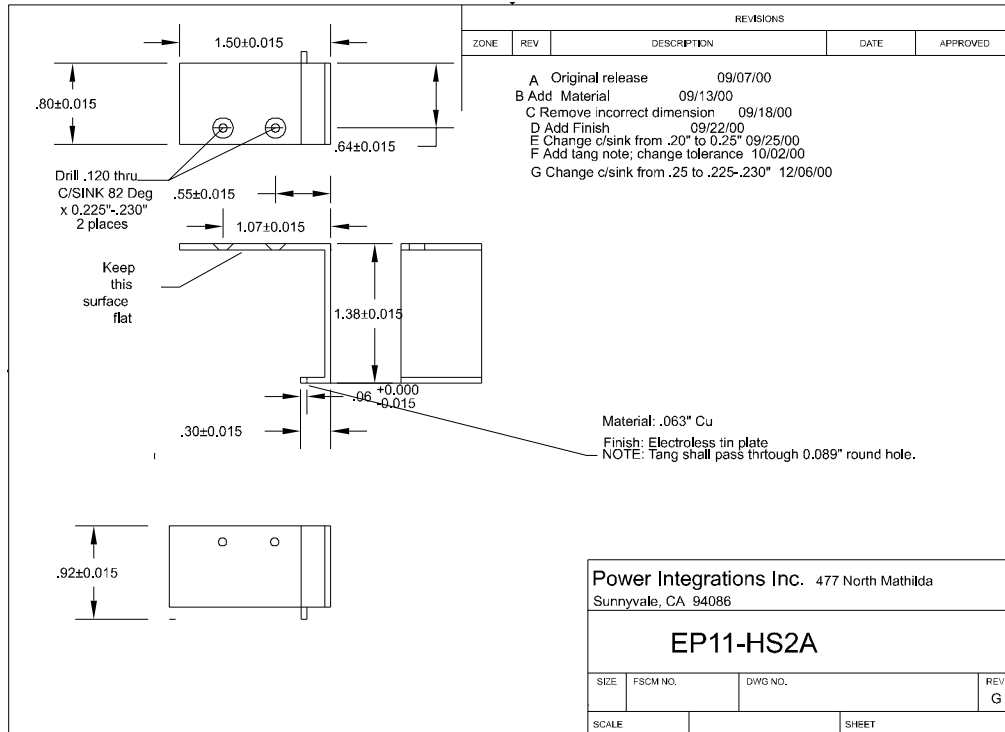

15 Revision History

Date	Author	Revision	Description & changes
10/16/00	DJK	0.1	Original draft
11/15/00	PV	1.0	First Release
11/17/00	PV	1.1	Update – added photo of thermocouple location plus removed typographical errors
12/06/00	PV	1.2	Added power levels to temp chart, low load efficiency, bode plots at zero load, 0 to 50% load transient, power density, enclosure internal dimensions.
12/08/00	PV	1.3	Thermal image added
01/22/01	PV	1.4	Appendix B, Materials, Item [1] changed from T50-26C to T50-26 to reflect correct part number



NOTES



For the latest updates, visit our website: www.powerint.com

Power Integrations reserves the right to make changes to its products at any time to improve reliability or manufacturability. Power Integrations does not assume any liability arising from the use of any device or circuit described herein, nor does it convey any license under its patent rights or the rights of others.

PI Logo and **TOPSwitch** are registered trademarks of Power Integrations, Inc.
©Copyright 2000, Power Integrations, Inc.

**WORLD HEADQUARTERS
NORTH AMERICA - WEST**

Power Integrations, Inc.
5245 Hellyer Avenue
San Jose, CA 95138 USA.
Main: +1•408•414•9200
Customer Service:
Phone: +1•408•414•9665
Fax: +1•408•414•9765

**NORTH AMERICA - EAST
& SOUTH AMERICA**

Power Integrations, Inc.
Eastern Area Sales Office
1343 Canton Road, Suite C1
Marietta, GA 30066 USA
Phone: +1•770•424•5152
Fax: +1•770•424•6567

EUROPE & AFRICA

Power Integrations (Europe)
Ltd.
Centennial Court
Easthampstead Road
Bracknell
Berkshire RG12 1YQ,
United Kingdom
Phone: +44•1344•462•300
Fax: +44•1344•311•732

TAIWAN

Power Integrations International
Holdings, Inc.
2F, #508, Chung Hsiao E. Rd.,
Sec. 5,
Taipei 105, Taiwan
Phone: +886•2•2727•1221
Fax: +886•2•2727•1223

CHINA

Power Integrations, China
Rm# 1705, Bao Hua Bldg.
1016 Hua Qiang Bei Lu
Shenzhen Guangdong, 518031
Phone: +86•755•377•9485
Fax: +86•755•377•9610

KOREA

Power Integrations International
Holdings, Inc.
Rm# 402, Handuk Building,
649-4 Yeoksam-Dong,
Kangnam-Gu,
Seoul, Korea
Phone: +82•2•568•7520
Fax: +82•2•568•7474

JAPAN

Power Integrations, K.K.
Keihin-Tatemono 1st Bldg.
12-20 Shin-Yokohama 2-
Chome,
Kohoku-ku, Yokohama-shi,
Kanagawa 222, Japan
Phone: +81•45•471•1021
Fax: +81•45•471•371

INDIA (Technical Support)

Innovatech
#1, 8th Main Road
Vasanthnagar
Bangalore 560052, India
Phone: +91•80•226•6023
Fax: +91•80•228•9727

APPLICATIONS HOTLINE

World Wide +1•408•414•9660

APPLICATIONS FAX

World Wide +1•408•414•9760

