

Electric toys — Safety

The European Standard EN 62115:2005 has the status of a
British Standard

ICS 97.200.50; 13.120

National foreword

This British Standard is the official English language version of EN 62115-2:2005. It was derived by CENELEC from IEC 62115:2003, including amendment 1:2004 modified. It supersedes BSEN 50088:1996 which will be withdrawn on 2008-01-01.

The CENELEC common modifications have been implemented at the appropriate places in the text. The start and finish of each common modification is indicated in the text by tags [C] <C>. Where a common modification has been introduced by amendment, the tags carry the number of the amendment. For example, the common modifications introduced by CENELEC amendment A11 are indicated by [C11] <C11>.

The start and finish of text introduced or altered by IEC amendment is indicated in the text by tags [A1] <A1>. Tags indicating changes to IEC text carry the number of the IEC amendment. For example, text altered by IEC amendment 1 is indicated by [A1] <A1>.

The UK participation in its preparation was entrusted by Technical Committee CPL/61, Safety of household electrical appliances, to Subcommittee CPL/61/21, Safety of toys, which has the responsibility to:

- aid enquirers to understand the text;
- present to the responsible international/European committee any enquiries on the interpretation, or proposals for change, and keep the UK interests informed;
- monitor related international and European developments and promulgate them in the UK.

A list of organizations represented on this committee can be obtained on request to its secretary.

Cross-references

The British Standards which implement international or European publications referred to in this document may be found in the *BSI Catalogue* under the section entitled “International Standards Correspondence Index”, or by using the “Search” facility of the *BSI Electronic Catalogue* or of British Standards Online.

This publication does not purport to include all the necessary provisions of a contract. Users are responsible for its correct application.

Compliance with a British Standard does not of itself confer immunity from legal obligations.

Summary of pages

This document comprises a front cover, an inside front cover, the EN title page, pages 2 to 38, an inside back cover and a back cover.

The BSI copyright notice displayed in this document indicates when the document was last issued.

Amendments issued since publication

Amd. No.	Date	Comments

This British Standard was published under the authority of the Standards Policy and Strategy Committee on 1 August 2005

© BSI 1 August 2005

ISBN 0 580 46091 6

EUROPEAN STANDARD

EN 62115

NORME EUROPÉENNE

EUROPÄISCHE NORM

April 2005

ICS 97.200.50; 13.120

Supersedes EN 50088:1996 + amendments

English version

**Electric toys –
Safety**
(IEC 62115:2003 + A1:2004, modified)

Jouets électriques –
Sécurité
(CEI 62115:2003 + A1:2004, modifiée)

Elektrische Spielzeuge –
Sicherheit
(IEC 62115:2003 + A1:2004, modifiziert)

This European Standard was approved by CENELEC on 2004-12-07. CENELEC members are bound to comply with the CEN/CENELEC Internal Regulations which stipulate the conditions for giving this European Standard the status of a national standard without any alteration.

Up-to-date lists and bibliographical references concerning such national standards may be obtained on application to the Central Secretariat or to any CENELEC member.

This European Standard exists in three official versions (English, French, German). A version in any other language made by translation under the responsibility of a CENELEC member into its own language and notified to the Central Secretariat has the same status as the official versions.

CENELEC members are the national electrotechnical committees of Austria, Belgium, Cyprus, Czech Republic, Denmark, Estonia, Finland, France, Germany, Greece, Hungary, Iceland, Ireland, Italy, Latvia, Lithuania, Luxembourg, Malta, Netherlands, Norway, Poland, Portugal, Slovakia, Slovenia, Spain, Sweden, Switzerland and United Kingdom.

CENELEC

European Committee for Electrotechnical Standardization
Comité Européen de Normalisation Electrotechnique
Europäisches Komitee für Elektrotechnische Normung

Central Secretariat: rue de Stassart 35, B - 1050 Brussels

© 2005 CENELEC - All rights of exploitation in any form and by any means reserved worldwide for CENELEC members.

Ref. No. EN 62115:2005 E

Foreword

During the Copenhagen meeting in May 2003, the CENELEC Technical Committee TC 61 decided to submit the text of the International Standard IEC 62115:2003, prepared by IEC TC 61, to the Unique Acceptance Procedure together with CENELEC common modifications.

The text of the draft common modifications, circulated in March 2004, included the content of the future amendment 1 to IEC 62115:2003. In view of the publication of this amendment in IEC, the relevant common modifications have been deleted and amendment 1:2004 to IEC 62115:2003 has been included in the European Standard which was approved by CENELEC as EN 62115 on 2004-12-07.

This European Standard replaces EN 50088:1996 + A1:1996 + A2:1997 + corrigenda April 2001 + A3:2002.

The following dates were fixed:

- latest date by which the EN has to be implemented
at national level by publication of an identical
national standard or by endorsement (dop) 2006-01-01
- date on which national standards
conflicting with the EN have to be withdrawn (dow) 2008-01-01

This European Standard has been prepared under a mandate given to CENELEC by the European Commission and the European Free Trade Association and covers essential requirements of EC Directive 88/378/EEC. See Annex ZZ.

NOTE The following print types are used:

- requirements: in roman type;
- *test specifications: in italic type;*
- notes: in small roman type.

Words in **bold** in the text are defined in Clause 3. When a definition concerns an adjective, the adjective and the associated noun are also in bold.

There are no special national conditions causing a deviation from this European Standard.

There are no national deviations from this European Standard.

Annexes ZA and ZZ have been added by CENELEC.

- p NOTE In this document, p is used in the margin to indicate instructions for preparing the printed version.

Endorsement notice

The text of the International Standard IEC 62115:2003 + A1:2004 was approved by CENELEC as a European Standard with agreed common modifications.

CONTENTS

INTRODUCTION.....	4
1 Scope	5
2 Normative references	5
3 Definitions.....	7
4 General requirement.....	9
5 General conditions for the tests	9
6 Criteria for reduced testing	11
7 Marking and instructions	12
8 Power input.....	15
9 Heating and abnormal operation	15
10 Electric strength at operating temperature.....	19
11 Moisture resistance	19
12 Electric strength at room temperature	20
13 Mechanical strength	20
14 Construction.....	21
15 Protection of cords and wires.....	23
16 Components	23
17 Screws and connections	24
18 Clearances and creepage distances.....	25
19 Resistance to heat and fire	25
20 Radiation, toxicity and similar hazards	26
Annex A (normative) Experimental sets	28
Annex B (normative) Needle-flame test	30
Annex C (normative) Automatic controls and switches	31
Annex D (informative) Sequence of the tests of Clause 19	33
Annex E (normative) Toys incorporating lasers and light-emitting diodes.....	34
Annex ZA (normative) Normative references to international publications with their corresponding European publications.....	35
Annex ZZ (informative) Coverage of Essential Requirements of EC Directives	37
Bibliography	38
Figure 1 – Example of an electronic circuit with low-power points.....	27

INTRODUCTION

It has been assumed in the drafting of this International Standard that the execution of its provisions is entrusted to appropriately qualified and experienced people.

As a general rule, toys are designed and manufactured for particular categories of children. Their characteristics are related to the age and stage of development of the children and their intended use presupposes certain capabilities.

Accidents are frequently due to a toy either being given to a child for whom it is not intended or being used for a purpose other than for which it was designed. This standard does not eliminate parental responsibility for the appropriate selection of toys. It is assumed that when choosing a toy or a game, account is taken of the physical and mental development of the child who will be playing with it.

The aim of this standard is to reduce risks when playing with toys, especially those risks that are not evident to users. However, it has to be recognized that some toys have risks inherent in their use that cannot be avoided. Consideration has been given to reasonably foreseeable use, bearing in mind that children are not generally as careful as adults.

While this standard applies to new toys, it nevertheless takes into account the wear and tear of toys in use.

The fact that a toy complies with this standard does not absolve parents and other persons in charge of a child from the responsibility of supervising the child. Supervision is also necessary when children of various ages have access to the same toy.

This standard covers the whole range of electric toys from small button cell operated lights to large sit-on cars powered by lead-acid cells. This results in different requirements and tests according to the type of toy. For some toys, testing can be reduced if particular criteria are met (see Clause 6).

A toy that complies with the text of this standard will not necessarily be judged to comply with the safety principles of the standard if, when examined and tested, it is found to have other features that impair the level of safety covered by these requirements.

A toy employing materials or having forms of construction differing from those detailed in the requirements of this standard may be examined and tested according to the intent of the requirements and, if found to be substantially equivalent, may be judged to comply with the standard.

ELECTRIC TOYS – SAFETY

1 Scope

This International Standard deals with the safety of **toys** that have at least one function dependent on electricity.

NOTE 1 Examples of **toys** also within the scope of this standard are

- **constructional sets**;
- **experimental sets**;
- functional **toys** (models that have a function similar to an appliance or installation used by adults);
- video **toys** (**toys** consisting of a screen and activating means, such as a joystick or keyboard. Separate screens having a **rated voltage** exceeding 24 V are not considered to be a part of the **toy**).

Additional requirements for **experimental sets** are given in Annex A.

Toys using electricity for secondary functions are within the scope of this standard.

NOTE 2 A doll's house having an interior lamp is an example of such a **toy**.

A1 Additional requirements for **toys** incorporating **lasers** and **light-emitting diodes** are given in Annex E. **A1**

In order to comply with this standard, electric toys also have to comply with **C** EN 71 **C**, since it covers hazards other than those arising by the use of electricity.

NOTE 3 **Transformers for toys** and battery chargers are not considered to be a **toy**, even if supplied with it.

NOTE 4 If it is intended that a child also plays with the packaging, the latter is considered to be part of the **toy**.

NOTE 5 This standard does not apply to

- toy steam engines;
- scale models for adult collectors;
- folk dolls and decorative dolls and other similar articles for adult collectors;
- sports equipment;
- aquatic equipment intended to be used in deep water;
- equipment intended to be used collectively in playgrounds;
- amusement machines (IEC 60335-2-82);
- professional **toys** installed in public places (shopping centres, stations, etc.);
- products containing heating elements intended for use under the supervision of an adult in a teaching context;
- portable child-appealing luminaires (IEC 60598-2-10);
- Christmas decorations.

2 Normative references

The following referenced documents are indispensable for the application of this document. For dated references, only the edition cited applies. For undated references, the latest edition of the referenced document (including any amendments) applies.

C EN 71-1:1998, *Safety of toys – Part 1: Mechanical and physical properties*

EN 71-3:1994, *Safety of toys – Part 3: Migration of certain elements* **C**

IEC 60068-2-75, *Environmental testing – Part 2-75: Tests – Test Eh: Hammer tests*

IEC 60083, *Plugs and socket-outlets for domestic and similar general use standardized in member countries of IEC*

IEC 60086-2, *Primary batteries – Part 2: Physical and electrical specifications*

IEC 60320-1, *Appliance couplers for household and similar general purposes – Part 1: General requirements*

IEC 60384-14, *Fixed capacitors for use in electronic equipment – Part 14: Sectional specification – Fixed capacitors for electromagnetic interference suppression and connection to the supply mains*

IEC 60417-1, *Graphical symbols for use on equipment – Part 1: Overview and application*

IEC 60529:1989, *Degrees of protection provided by enclosures (IP Code)*

IEC 60695-2-2:1991, *Fire hazard testing – Part 2: Test methods – Section 2: Needle-flame test*

IEC 60695-2-11, *Fire Hazard testing – Part 2-11: Glowing/hot-wire based test methods – Glow-wire flammability test method for end-products*

IEC 60695-2-13, *Fire hazard testing – Part 2-13: Glowing/hot-wire based test methods – Glow-wire ignitability test method for materials*

IEC 60695-10-2, *Fire hazard testing – Part 10: Guidance and test methods for the minimization of the effects of abnormal heat on electrotechnical products involved in fires – Section 2: Method for testing products made from non-metallic materials for resistance to heat using the ball pressure test*

IEC 60695-11-10, *Fire hazard testing – Part 11-10: Test flames – 50 W horizontal and vertical flame test methods*

IEC 60730-1:1999, *Automatic electrical controls for household and similar use – Part 1: General requirements*

IEC 60738-1, *Thermistors – Directly heated positive step-function temperature coefficient – Part 1: Generic specification*

A1 IEC 60825-1:1993, *Safety of laser products – Part 1: Equipment classification, requirements and user's guide*
Amendment 1 (1997)

Amendment 2 (2001) including its corrigendum 1 (2002)¹ **A1**

IEC 61032:1997, *Protection of persons and equipment by enclosures – Probes for verification*

IEC 61058-1:2000, *Switches for appliances – Part 1: General requirements*

IEC 61558-2-7, *Safety of power transformers, power supply units and similar – Part 2: Particular requirements for transformers for toys*

ISO 7000, *Graphical symbols for use on equipment – Index and synopsis*

C Text deleted **C**

ISO 9772, *Cellular plastics – Determination of horizontal burning characteristics of small specimens subjected to a small flame*

¹ There exists a consolidated edition 1.2 (2001) that includes edition 1 and its amendments 1 and 2.

3 Definitions

For the purpose of this standard, the following definitions apply.

NOTE When the terms “voltage” and “current” are used, they imply r.m.s. values unless otherwise specified.

3.1.1

toy

product intended for use by children under 14 years old for playing purposes

3.1.2

battery toy

toy that contains or uses one or more batteries as the only source of electrical energy

NOTE The batteries may be in a **battery box**.

3.1.3

transformer toy

toy that is connected to the supply mains through a **transformer for toys** and using the supply mains as the only source of electrical energy

3.1.4

dual-supply toy

toy that can be operated as a **battery toy** and either simultaneously or alternatively as a **transformer toy**

3.1.5

battery box

separate compartment for containing the batteries that is detachable from the **toy**

3.1.6

replaceable battery

battery that can be replaced without breaking the **toy**

3.1.7

safety isolating transformer

transformer, the input winding of which is electrically separated from the output winding by insulation at least equivalent to double insulation or reinforced insulation, which provides a supply at safety extra-low voltage

3.1.8

transformer for toys

safety isolating transformer specially designed to supply **toys** operating at safety extra-low voltage not exceeding 24 V

NOTE The transformer may supply a.c. or d.c., or both.

3.1.9

constructional set

collection of electric, electronic or mechanical parts intended to be assembled as various **toys**

3.1.10

experimental set

collection of electric, electronic or mechanical components intended to be assembled in various combinations to demonstrate physical phenomena or other functions by children.

NOTE The assembly is not intended to create a **toy** or product for practical use.

3.2.1**rated voltage**

voltage assigned to the **toy** by the manufacturer

3.2.2**working voltage**

maximum voltage to which the part under consideration is subjected when the **toy** is supplied at its **rated voltage** and operating under **normal operation**

NOTE The change of voltage resulting from the operation of a switch or failure of a lamp is taken into account. However, the effect of transient voltages is ignored.

3.2.3**rated power input**

power input assigned to the **toy** by the manufacturer

3.2.4**rated current**

current assigned to the **toy** by the manufacturer

NOTE If no current is assigned to the **toy**, the **rated current** is the current measured when the **toy** is supplied at **rated voltage** and operated under **normal operation**.

3.2.5**normal operation**

condition under which the **toy** is played with as intended or in a foreseeable way when it is energized.

Sit-on **toys** and stand-on **toys** are loaded with

- 25 kg, if intended for children up to 3 years old;
- 50 kg, if intended for older children

3.3.1**clearance**

shortest distance in air between two conductive parts or between a conductive part and the **accessible surface**

3.3.2**creepage distance**

shortest distance along the surface of insulation between two conductive parts or between a conductive part and the **accessible surface**

3.4.1**detachable part**

part that can be removed without the aid of a **tool**, a part that can be removed by a **tool** supplied with the **toy**, or a part that is removed in accordance with the instructions for use even if a **tool** is needed for removal

NOTE A part that can be opened is considered to be a part that can be removed.

3.4.2**accessible part**

part or surface that can be touched by means of test probe 18 or 19 of IEC 61032, depending on the relevant age group

NOTE Both probes are relevant for **toys** intended for children spanning the two age groups.

3.4.3**tool**

screwdriver, coin or other object that may be used to operate a screw, clip or similar fixing means

3.5.1

thermostat

temperature-sensing device, the operating temperature of which may be either fixed or adjustable and which during **normal operation** keeps the temperature of the controlled part between certain limits by automatically opening and closing a circuit

3.5.2

thermal cut-out

device that during abnormal operation limits the temperature of the controlled part by automatically opening the circuit or by reducing the current and that is constructed so that its setting cannot be altered by the user

3.5.3

self-resetting thermal cut-out

thermal cut-out that automatically restores the current after the relevant part of the **toy** has cooled down sufficiently

3.5.4

non-self-resetting thermal cut-out

thermal cut-out that requires a manual operation for resetting or replacement of a part, in order to restore the current

3.5.5

electronic component

part in which conduction is achieved principally by electrons moving through a vacuum, gas or semiconductor

NOTE Electronic components do not include resistors, capacitors and inductors.

3.5.6

electronic circuit

circuit incorporating at least one **electronic component**

4 General requirement

Toys shall be constructed so that they do not jeopardise the safety and/or health of users or third parties when they are used as intended or in a foreseeable way, bearing in mind the normal behaviour of children.

5 General conditions for the tests

Unless otherwise specified, tests are carried out in accordance with this clause.

NOTE Some tests on **battery toys** can result in rupture or explosion of the batteries. Adequate precautions should be taken when conducting such tests.

5.1 Tests according to this standard are type tests.

5.2 The tests are carried out on a single sample that shall withstand all the relevant tests. However, the tests of Clauses 14 to 17 may be made on separate samples. If the **toy** does not operate after the tests of Clause 9, the subsequent tests are carried out on a separate sample.

NOTE 1 Additional samples may be required if the **toy** is constructed

- for different supply voltages;
- for both a.c. and d.c.;
- for different speeds.

NOTE 2 The testing of components may require the submission of additional samples of these components.

NOTE 3 The cumulative stress resulting from successive tests on **electronic circuits** is to be avoided. It may be necessary to replace components or to use additional samples. The number of additional samples should be kept to a minimum by an evaluation of the relevant **electronic circuits**.

5.3 The tests are carried out in the order of the clauses.

*If it is evident from the construction of the **toy** that a particular test is not applicable, this test is not carried out.*

5.4 If a **toy** is intended to be assembled by a child, the requirements apply to each part accessible to the child and to the assembled **toy**. If a **toy** is intended to be assembled by an adult, the requirements apply to the assembled **toy**.

5.5 The tests are carried out with the **toy** or any movable part of it placed in the most unfavourable position when the **toy** is used as intended or in any foreseeable way. Battery compartment covers are opened or removed. Other **detachable parts** are removed or kept in position, whichever is more unfavourable.

5.6 Toys provided with controls or switching devices are tested with these controls or devices adjusted to their most unfavourable setting, if the setting can be altered by the user.

5.7 **Detachable cords** supplied with the **toy** are considered to be part of the **toy** and are tested with it.

5.8 **Battery toys** intended for use with a **battery box** are tested with the **battery box** supplied with the **toy** or with the **battery box** recommended in the instructions.

***Transformer toys** are tested with the transformer supplied with the **toy**. If the **toy** is supplied without a transformer, it is tested with a transformer recommended in the instructions.*

***Dual-supply toys** are tested with the most unfavourable supply allowed by the construction, the type of supply being evaluated for each test.*

5.9 **Battery toys** are tested using new non-rechargeable batteries or fully charged rechargeable batteries, whichever is more unfavourable.

NOTE 1 In general a fully charged nickel-cadmium battery or a new alkaline battery is considered to be the most unfavourable battery.

*The batteries used are those with the voltage and size specified on the **toy** or in the instructions. Similar batteries that are generally available are used if this results in more unfavourable conditions.*

NOTE 2 Lithium batteries are not used unless their use is recommended in the instructions.

NOTE 3 If the toy fails to withstand a test and this could be due to a defective battery, the test is repeated with a new set of batteries.

5.10 *When alternative accessories are made available by the manufacturer, the **toy** is tested with those accessories that give the most unfavourable results.*

NOTE 1 Examples of accessories are lamps, motors and rails.

If accessories can be used simultaneously, the combination that gives the most unfavourable result is used.

NOTE 2 Accessories may be selected from more than one set.

NOTE 3 An accessory may be replaced by a simulated load for the tests.

Toys having lamps used as heating elements that can be removed without the aid of a **tool** are tested with lamps of the highest power input that can be fitted, irrespective of any marking.

NOTE 4 The lamps are selected from the types generally available.

5.11 *The tests are carried out in a draught-free location at an ambient temperature of 20 °C ± 5 °C.*

5.12 **Toys** having more than one **rated voltage** are tested at the most unfavourable voltage. **Toys** for a.c. only are tested with a.c. at rated frequency if marked, and those for a.c./d.c. are tested at the most unfavourable frequency. If the frequency is not marked, the **toy** is tested with 50 Hz or 60 Hz as appropriate.

5.13 **Battery toys** are also tested with the polarity reversed unless such connections are prevented by the construction.

5.14 **Batteries** are correctly positioned before evaluating the possibility of bridging insulation and before carrying out the short-circuit tests.

Only one short circuit is applied at a time. Damage caused by a short circuit that does not impair compliance with this standard is repaired before a further short circuit is applied.



5.15  Before starting the tests, the toy is preconditioned by subjecting it to the tests of the following subclauses of EN 71-1, the batteries in position:

- 8.5 Drop test, for **toys** having a mass less than 5 kg including batteries, irrespective of the age group;
- 8.21 Static strength test for sit-on or stand-on **toys**;
- 8.22 Dynamic strength test for wheeled ride-on **toys**;
- 8.4.2.1 Tension test, however, the force being 70 N independent of the dimensions and applicable independent of age group;
- 8.4.2.2 Tension test for seams, for toys having textile or other flexible materials covering batteries or other electrical parts.

NOTE Compliance with EN 71-1 is not checked after the preconditioning. However the security of the battery compartment cover is checked (see 14.6 and 14.7). 

6 Criteria for reduced testing

For some **toys**, it is not necessary to carry out all the tests specified in this standard if the conditions of 6.1 or 6.2 are met. The exemptions of 6.1 are applicable to all **toys**, whereas those of 6.2 are only applicable to **battery toys**.

6.1 **Toys** that comply with the tests of Clause 9 with the insulation between parts of different polarity short-circuited are considered to comply with  Clauses 10, 11.2 and 12 , 15

and 18. The short circuit is applied at all places in turn where the insulation is liable to breakdown and can be carried out using a flexible wire.

6.2 Battery toys are considered to comply with $\square C$ Clauses 9 (except 9.3 and 9.6) $\square C$, 10, 11 (except 11.1), 12, 15 and 17 to 19 if

- the accessible insulation between parts of different polarity cannot be bridged by a straight steel pin having a diameter of 0,5 mm and any suitable length over 25 mm, and
- the total battery voltage does not exceed 2,5 V, measured 1 s after a 1 Ω resistor has been connected between the supply terminals of the **toy**, with any current limiting device short-circuited and without the **toy** being operated.

$\square C$ For battery compartments including button cell batteries, 17.1 is always applicable. $\square C$

7 Marking and instructions

7.1 Toys or their packaging shall be marked with

- the name, trade mark or identification mark of the manufacturer or responsible vendor;
- the model or type reference.

When the **toy** is marked, these markings shall be on the main part. When the packaging is not marked and when it is not practical to mark the **toy**, e.g. due to its size, the markings of 7.1.1 to 7.1.3 $\square C$ shall $\square C$ be contained in the instructions instead.

NOTE 1 In addition, the marking requirements of $\square C$ EN 71-1 $\square C$ may be applicable.

NOTE 2 Additional markings are allowed, provided they do not give rise to misunderstanding.

Compliance is checked by inspection.

7.1.1 Battery toys with replaceable batteries shall be marked with

- the nominal battery voltage, in or on the battery compartment;
- the symbol for d.c., if the **toy** has a **battery box**.

If more than one battery is used, the battery compartment shall be marked with the shape of the batteries in proportional size, together with their nominal voltage and polarity.

Compliance is checked by inspection.

NOTE Examples representing three batteries are

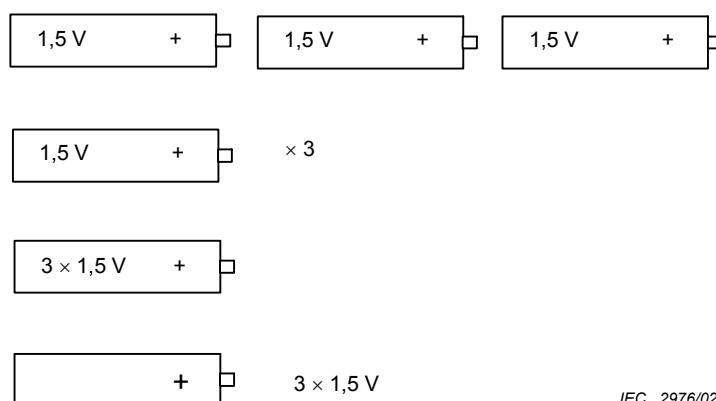

IEC 2976/02

7.1.2 Transformer toys shall be marked with

- their **rated voltage**, in volts;
- the symbol for a.c. or d.c., as applicable;
- their **rated power input**, in watts or volt-amperes, if greater than 25 W or 25 VA;
- the symbol for **transformer for toys**. This symbol shall also be marked on the packaging.

The marking of **rated voltage** and the symbol for a.c. or d.c. shall be placed adjacent to the terminals. The marking for a.c. or d.c. is not required if the incorrect supply does not impair compliance with this standard.

Compliance is checked by inspection.

7.1.3 Dual-supply toys shall be marked with the marking required for both **battery toys** and **transformer toys**.

Compliance is checked by inspection.

7.2 The identification for **detachable lamps** shall be marked with

- the rated voltage and type number, or
- the maximum power input, or
- the maximum current.

The marking for power input or current of **detachable lamps** shall be as follows:

lamp max ... W or lamp max ... A



The word "lamp" may be replaced by symbol 5012 of IEC 60417-1.

The marking shall be visible when replacing the lamp.

This marking is not required if the temperature rises measured during the tests of Clause 9 do not exceed the limits when a lamp having the highest power input is fitted.

Compliance is checked by inspection.

7.3 When symbols are used, they shall be as follows:

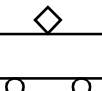
	[symbol 5031 of IEC 60417-1]	direct current
	[symbol 5032 of IEC 60417-1]	alternating current
	[symbol 5012 of IEC 60417-1]	lamp
	[symbol 5219 of IEC 60417-1]	safety isolating transformer for toys (symbol for transformer toys)

NOTE 1 Additional symbols are allowed, provided they do not give rise to misunderstanding.

NOTE 2 Symbols specified in IEC 60417-1 and ISO 7000 may be used.

Units of physical quantities and their symbols shall be those of the international standardized system.

Compliance is checked by inspection.

7.4 Instructions shall be provided that give details concerning cleaning and maintenance when necessary for the safe operation of the **toy**. They shall state that transformers or battery chargers used with the **toy** are to be regularly examined for damage to the cord, plug, enclosure and other parts, and in the event of such damage, they must not be used until the damage has been repaired.

Toys shall be provided with instructions for assembly if



- they are intended to be assembled by a child;
- these instructions are necessary for safe operation of the **toy**.

If the **toy** is intended to be assembled by an adult, this shall be stated.

The instructions for **transformer toys** and **toys** with **battery boxes** shall state that the toy is not to be connected to more than the recommended number of power supplies.

Toys having wires without connecting means shall be provided with instructions that state that the wires are not to be inserted into socket-outlets.

The instructions for **battery toys** with **replaceable batteries** shall contain the substance of the following, as applicable:

-  *Text deleted* .
- how to remove and insert the batteries;
- non-rechargeable batteries are not to be recharged;
- rechargeable batteries are only to be charged under adult supervision;
- rechargeable batteries are to be removed from the toy before being charged;
- different types of batteries or new and used batteries are not to be mixed;
- batteries are to be inserted with the correct polarity;
- exhausted batteries are to be removed from the toy;
- the supply terminals are not to be short-circuited.

The instructions for **transformer toys** shall contain the substance of the following, as applicable:

- the toy is not intended for children under 3 years old;
- the toy must only be used with the recommended transformer;
- the transformer is not a toy;
- toys liable to be cleaned with liquids are to be disconnected from the transformer before cleaning.

The instructions may be on a leaflet, on the packaging or on the **toy**. If the instructions are marked on the **toy**, they shall be visible from the outside and if the **toy** consists of more than one part, only the main part needs to be marked.

Instructions for **battery toys** intended to be used in water shall state that the **toy** is to be operated in water only when fully assembled in accordance with the instructions.

Compliance is checked by inspection.

7.5 When markings or instructions are on the packaging, it shall also be stated that the packaging must be retained since it contains important information.

Compliance is checked by inspection.

7.6 Instructions and other texts required by this standard shall be written in the official language of the country in which the **toy** is to be sold.

Compliance is checked by inspection.

7.7 The markings on the **toy** shall be legible and durable.

Compliance is checked by inspection and by rubbing the marking by hand for 15 s with a piece of cloth soaked with water and again for 15 s with a piece of cloth soaked with petroleum spirit. When the use of other liquids is recommended, the rubbing test is also carried out with the cloth soaked with these liquids.

After all the tests of this standard, the marking shall be legible, it shall not be easily possible to remove marking plates and they shall show no curling.

NOTE 1 In considering the durability of the marking, the effect of normal wear such as frequent cleaning is taken into account.

NOTE 2 The petroleum spirit to be used for the test is aliphatic solvent hexane having a maximum aromatics content of 0,1 % by volume, a kauri-butanol value of 29, an initial boiling point of approximately 65 °C, a dry point of approximately 69 °C and a specific mass of approximately 0,66 kg/l.

8 Power input

The power input of **transformer toys** shall not exceed the **rated power input** by more than 20 %.

*Compliance is checked by measurement when the power input has stabilized and the **toy** has attained normal operating temperature with*

- *all circuits that can operate simultaneously being in operation;*
- *the **toy** being supplied at **rated voltage**;*
- *the **toy** being operated under **normal operation**.*

NOTE The power input has to be measured to determine if the **rated power input** needs to be marked.

9 Heating and abnormal operation

9.1 Toys shall not attain excessive temperatures in use. They shall be constructed so that the risk of fire, mechanical damage impairing safety or other hazards, as a result of careless use or failure of a component, is obviated as far as is practicable.

***Toys** are subjected to the tests of 9.3 to 9.8 under the conditions specified in 9.2.*

*All **toys** are subjected to the tests of 9.3 to 9.5.*

***Toys** incorporating motors are subjected to the test of 9.6.*

***Transformer toys** and **toys** with **battery boxes** are subjected to the test of 9.7.*

Toys incorporating electronic circuits are subjected to the test of 9.8.

Toys that only incorporate incandescent lamps having a rated power input not exceeding 1 W are not subjected to the tests.

Unless otherwise specified, compliance with the tests of this clause is checked as described in 9.9.

The tests of 9.3 and 9.4 are continued until steady conditions are established. During these tests, **thermal cut-outs** shall not operate.

The tests of 9.5 to 9.8 are continued until a **non-self-resetting thermal cut-out** operates or until steady conditions are established. If a heating element or an intentionally weak part becomes permanently open-circuited, the relevant test is repeated on a second sample. This second test shall be terminated in the same mode unless the test is otherwise satisfactorily completed.

NOTE 1 An intentionally weak part is a part intended to rupture in order to prevent the occurrence of a condition that would impair compliance with this standard. Such a part may be a replaceable component, such as a resistor or a capacitor or a part of a component to be replaced, such as an inaccessible thermal link incorporated in a motor.

NOTE 2 Fuses, **thermal cut-outs**, overcurrent protection devices or similar devices incorporated in the **toy** may be used to provide the necessary protection.

NOTE 3 If more than one of the tests are applicable to the same **toy**, these tests are made consecutively after the **toy** has cooled down to room temperature.

9.2 Toys are placed in the most unfavourable position that can occur during play.

Hand-held toys are freely suspended.

Other toys are placed on the floor of a test corner as near to the walls as possible or away from the walls, whichever is more unfavourable. The test corner consists of two walls at right angles and a floor made of dull black-painted plywood having a thickness of approximately 20 mm. They are covered with four layers of bleached cotton gauze having dimensions of 500 mm x 500 mm and a specific mass of $40 \text{ g/m}^2 \pm 8 \text{ g/m}^2$. The gauze is placed on surfaces where high temperatures and charring may be expected. **Toys** having dimensions not exceeding 500 mm are completely covered with the cotton gauze.



Battery toys are supplied at **rated voltage**.

Transformer toys are supplied at 0,94 times or 1,06 times **rated voltage**, whichever is more unfavourable.

The temperature rises are determined by means of fine-wire thermocouples positioned so that they have minimum effect on the temperature of the part under test.

NOTE Thermocouples having wires with a diameter not exceeding 0,3 mm are considered to be fine-wire thermocouples.

9.3 Toys are operated under **normal operation** and the temperature rises of the various parts are determined.

9.4 The test of 9.3 is repeated, the insulation between parts of different polarity being short-circuited in turn if it is accessible after the removal of **detachable parts**, except lamps. However, the short circuit is only applied if it is possible to bridge the insulation by a straight steel pin having a diameter of 0,5 mm and any suitable length over 25 mm, or by a rod having a diameter of 1,0 mm inserted through holes in the enclosure up to a depth of 100 mm. The pin is applied only with sufficient force to hold it in position  and only inserted through holes where one pole can be seen from the outside .

9.5 *The test of 9.3 is repeated, any control that limits the temperature during the tests of 9.3 and 9.4 being short-circuited. If the **toy** has more than one control, they are short-circuited in turn.*

9.6 *The test of 9.3 is repeated with accessible moving parts locked.*

NOTE If the **toy** incorporates more than one motor, the test is carried out by locking moving parts driven by each motor in turn.

*The test is terminated after 30 s if the **toy** has to be kept switched on by hand or foot.*

9.7 *Transformer toys and toys with battery boxes are connected to a power supply in addition to that recommended in the instructions for use. The additional power supply is identical to that recommended for the **toy** and is connected in series or in parallel, whichever is more unfavourable. The **toy** is then tested as specified in 9.3 and 9.4.*

NOTE The test is only applicable if the connections can be made easily without the aid of a **tool** and by using parts from two identical **toys** or **constructional sets**

9.8 *Compliance for **electronic circuits** is checked by evaluation of the fault conditions specified in 9.8.2 for all circuits or parts of circuits, unless they comply with the conditions specified in 9.8.1.*

*If a conductor of a printed-circuit board becomes open-circuited, the **toy** is considered to have withstood the particular test, provided that the following two conditions are met:*

- *the material of the printed-circuit board withstands the needle-flame test of Annex B;*
- *the **toy** withstands the test of 9.8.2 with the open-circuited conductor bridged.*

NOTE In general, examination of the **toy** and its circuit diagram will reveal the fault conditions that have to be simulated, so that testing can be limited to those cases that may be expected to give the most unfavourable results.

9.8.1 *Fault conditions a) to f) specified in 9.8.2 are not applied to circuits or parts of circuits where both of the following conditions are met:*

- *the **electronic circuit** is a low-power circuit as described below;*
- *the protection against fire hazard or dangerous malfunction in other parts of the **toy** does not rely on the correct functioning of the **electronic circuit**.*

A low-power circuit is determined as follows; an example is shown in Figure 1.

*The **toy** is supplied at **rated voltage** and a variable resistor adjusted to its maximum resistance is connected between the point to be investigated and the opposite pole of the supply source.*

The resistance is then decreased until the power consumed by the resistor reaches a maximum. Points closest to the supply at which the maximum power delivered to this resistor does not exceed 15 W at the end of 5 s are called low-power points. The part of the circuit farther from the supply source than a low-power point is considered to be a low-power circuit.

NOTE 1 The measurements are made from only one pole of the supply source, preferably the one that gives the fewest low-power points.

NOTE 2 When determining the low-power points, it is recommended to start with points close to the supply source.

9.8.2 *The following fault conditions are considered and, if necessary, applied one at a time, consequential faults being taken into consideration:*

- a) *short circuit of **clearances** and **creepage distances** between parts of different polarity, if these distances are less than the values specified in Clause 18, unless the relevant part is adequately encapsulated;*
- b) *open circuit at the terminals of any component;*
- c) *short circuit of capacitors, unless they comply with IEC 60384-14;*
- d) *short circuit of any two terminals of an **electronic component**, other than integrated circuits;*
- e) *failure of triacs in the diode mode;*
- f) *failure of an integrated circuit. In this case the possible hazardous situations of the **toy** are assessed to ensure that safety does not rely on the correct functioning of such a component. All possible output signals are considered under fault conditions within the integrated circuit. If it can be shown that a particular output signal is unlikely to occur, then the relevant fault is not considered.*

NOTE 1 Components such as thyristors and triacs are not subjected to fault condition f).

NOTE 2 Microprocessors are tested as integrated circuits.

In addition, each low-power circuit is short-circuited by connecting the low-power point to the pole of the supply from which the measurements were made.

*For simulation of the fault conditions, the **toy** is operated under the conditions specified in 9.2 but supplied at **rated voltage**.*

*If the **toy** incorporates an electronic circuit that operates to ensure compliance with 9.5 to 9.7, the relevant test is repeated with a single fault simulated, as indicated in a) to f) above.*

Fault condition f) is applied to encapsulated and similar components if the circuit cannot be assessed by other methods.

PTC resistors are not short-circuited if they are used within the manufacturer's specification. However, PTC-S thermistors are short-circuited unless they comply with IEC 60738-1.

9.9 *During the tests, the temperature rises of accessible parts are monitored continuously.*

The temperature rise of the surface of handles, knobs and other parts that are likely to be touched by hand shall not exceed the following values:

- *25 K, for parts of metal;*
- *30 K, for parts of glass or porcelain;*
- *35 K, for parts of plastic or wood.*

*The temperature rise of other **accessible parts** of the **toy** shall not exceed the following values:*

- *45 K, for parts of metal;*
- *50 K, for parts of glass or porcelain;*
- *55 K, for parts of other materials.*

NOTE 1 The surface of batteries is considered to be metal.

NOTE 2 The temperature of the terminals of switches is measured if the switch is tested in accordance with Annex C.

During the tests,

- *sealing compound shall not flow out;*
- *the **toy** shall not emit flames or molten metal;*

- *dangerous substances shall not be produced, such as poisonous or ignitable gas in hazardous amounts;*
- *vapour shall not accumulate in the **toy**;*
- *enclosures shall not deform to such an extent that compliance with this standard is impaired;*
- *batteries shall not leak hazardous substances or erupt;*
- *materials, including the cotton gauze, shall not char.*

*After the tests, the **toy** shall not be damaged to such an extent that compliance with this standard is impaired.*

10 Electric strength at operating temperature

The electrical insulation of the **toy** at operating temperature shall be adequate.

Compliance is checked by the following test.

*The **toy** is operated as specified in 9.3 and 9.4. One terminal of all components connected across the supply is disconnected and the insulation between parts of different polarity is then subjected for 1 min to a voltage of substantially sinusoidal waveform having a frequency of 50 Hz or 60 Hz and a value of 250 V.*

No breakdown shall occur.

11 Moisture resistance

11.1 Battery toys intended to be used in water and **toys** likely to be cleaned with liquid shall have an enclosure providing the appropriate protection.

NOTE 1 **Toys** intended to be used to imitate the preparation of food are examples of **toys** likely to be cleaned with liquid.

*Compliance for **toys** likely to be cleaned with liquid is checked by the test of subclause 14.2.4 of IEC 60529, **detachable parts** having been removed.*

*Excess water is then removed from the enclosure. The **toy** shall withstand the electric strength test of Clause 12 and inspection shall show that there is no trace of water on insulation that could result in a reduction of **creepage distances** and **clearances** below the values specified in Clause 18.*

*Compliance for **battery toys** intended to be used in water is checked by the following test, **detachable parts** being removed if this is more unfavourable.*

*The **toy** is immersed in water containing approximately 1 % NaCl, all parts of the **toy** being at least 150 mm below the surface. The **toy** is positioned in the most unfavourable orientation and operated for 15 min. There shall be no overpressure within the enclosure due to entrapped gas.*

NOTE 2 Entrapped gas can result from an electrochemical reaction within the battery or between other electric parts of the **toy**.

NOTE 3 Gas pressure can be limited by an overpressure valve, by a gas absorber or in battery compartments by providing a suitable aperture.

*The **toy** is then taken out of the water, positioned to allow excess water to drain, and the enclosure is wiped dry. The **toy** shall withstand the electric strength test of Clause 12.*

11.2 Toys shall be resistant to humidity.

Compliance is checked by the following test.

Detachable parts are removed and subjected, if necessary, to the humidity test with the main part.

*The humidity test is carried out for 48 h in a humidity cabinet containing air with a relative humidity of (93 ± 3) %. The temperature of the air is maintained within 1 K of any convenient value t between 20 °C and 30°C. Before being placed in the humidity cabinet, the **toy** is brought to a temperature of t_{-0}^{+4} °C.*

*The **toy** shall then withstand the test of Clause 12 in the humidity cabinet or in the room in which the **toy** was brought to the prescribed temperature after reassembly of those parts that may have been removed.*

NOTE 1 In most cases, the **toy** may be brought to the specified temperature by keeping it at this temperature for at least 4 h before the humidity test.

NOTE 2 A relative humidity of (93 ± 3) % can be obtained by placing, in the humidity cabinet, a saturated solution of Na₂SO₄ or KNO₃ in water, the container having a sufficiently large contact surface with the air.

NOTE 3 The specified conditions may be achieved by ensuring a constant circulation of the air within a thermally insulated cabinet.

12 Electric strength at room temperature

The electric insulation of the **toy** at room temperature shall be adequate.

Compliance is checked by the following test.

One terminal of all components connected across the supply is disconnected and the insulation between parts of different polarity is subjected for 1 min to a voltage of substantially sinusoidal waveform having a frequency of 50 Hz or 60 Hz and a value of 250 V.

No breakdown shall occur.

13 Mechanical strength

Enclosures shall have adequate mechanical strength.

Compliance is checked by applying test Ehb of IEC 60068-2-75.

*The **toy** is rigidly supported and six blows are applied to every point of the enclosure that is likely to be weak with an impact energy of 0,7 J.*

*The **toy** shall not be damaged to such an extent that compliance with this standard is impaired.*

If there is doubt as to whether a defect has occurred by the application of preceding blows, this defect is neglected and a group of six blows is applied to the same place on a new sample that shall then withstand the test.

NOTE 1 Examples of enclosures that are subjected to the test are

- enclosures of compartments for non-sealed batteries containing a liquid;
- enclosures covering insulation between parts of different polarity, unless the **toy** complies with the test of 9.4 even if the enclosure is non-detachable;
- enclosures covering moving parts that may present a hazard.

NOTE 2 Lamps are not subjected to the test.

NOTE 3 Minor damage that does not reduce **clearances** and **creepage distances** below the values specified in Clause 18, or does not adversely affect the protection against moisture, is neglected.

NOTE 4 Cracks not visible to the naked eye are ignored.

14 Construction

14.1 Toys shall be **battery toys**, **transformer toys** or **dual-supply toys**. Their supply voltage shall not exceed 24 V.

The **working voltage** between any two parts of the **toy** shall not exceed 24 V when the **toy** is supplied at **rated voltage**.

NOTE The **working voltage** takes into account the failure of a filament lamp.

Compliance is checked by inspection and by measurement.

14.2 The transformer of **transformer toys** shall not be an integral part of the **toy**.

Controls for the **toy** shall not be incorporated in the transformer. [C] *Text deleted* [C]

Compliance is checked by inspection.

14.3 Transformer toys shall not be intended for use in water.

Compliance is checked by inspection.

14.4 Transformer toys shall not be intended for use by children under 3 years old.

Compliance is checked by inspection.

14.5 Non-self-resetting thermal cut-outs, necessary for compliance with this standard, shall only be resettable with the aid of a **tool**.

Compliance is checked by inspection and by a manual test.

14.6 Button cells and batteries designated R1 shall not be accessible without the aid of a **tool** unless the cover of their compartment can only be opened after at least two independent movements have been applied simultaneously.

Compliance is checked by inspection and by manual test.

NOTE Batteries are specified in IEC 60086-2.

14.7 The batteries of **toys** intended for children under 3 years old shall not be removable without the aid of a **tool** unless the security of the battery compartment cover is adequate.

Compliance is checked by inspection and by the following test.

An attempt is made to gain access to the battery compartment by manual means. It shall not be possible to open the cover unless at least two independent movements have to be applied simultaneously.

*The **toy** is placed on a horizontal steel surface. A cylindrical metallic mass of 1 kg, having a diameter of 80 mm, is dropped from a height of 100 mm so that its flat face falls onto the **toy**. The battery compartment shall not become open.*

The battery compartment shall not have become open as a result of the preconditioning of 5.15.

14.8 Rechargeable batteries shall not leak when the **toy** is placed in any position. The electrolyte shall not become accessible even if a **tool** has to be used to remove covers or similar parts.

Compliance is checked by inspection.

14.9 **Toys** shall not be supplied by batteries connected in parallel unless a mixture of used and new batteries, or the reverse insertion of batteries, does not impair compliance with this standard.

Compliance is checked by inspection or by a review of the circuit diagram.

14.10 Plugs and socket-outlets of **toys** shall not be interchangeable with plugs and socket-outlets listed in IEC 60083 or with connectors and appliance inlets complying with the standard sheets of IEC 60320-1.

Toys intended for children under 3 years old shall not use cords and wires without connectors.

Compliance is checked by inspection and by manual test.

14.11 Non-detachable parts that prevent contact with moving parts or hot surfaces, or access to locations where explosion or fire could be initiated, shall be fixed in a reliable manner and shall withstand the mechanical stress occurring during normal use.

Compliance is checked by applying the following pull force:

- 50 N, if the longest accessible dimension of the part does not exceed 6 mm;
- 90 N, for other parts.

The force is gradually applied during a period of 5 s and maintained for a further 10 s.

The part shall not become detached.

14.12 It shall not be possible to charge rechargeable batteries when they are in the **toy** unless

- for **toys** having a mass not exceeding 5 kg, it is not possible
 - to remove the battery without breaking the **toy**;
 - to charge other batteries from the **toy**;
- for other **toys**
 - the battery is fixed in the **toy**;
 - connecting means are provided that ensure correct polarity during charging;
 - it is not possible to operate the **toy** during charging.

Compliance is checked by inspection.

14.13 **Toys** shall not incorporate series motors having a power input exceeding 20 W.

*Compliance is checked by measurement, the **toy** being supplied at **rated voltage** and operated under **normal operation**.*

14.14 Toys shall not contain asbestos.

Compliance is checked by inspection.

15 Protection of cords and wires

15.1 Wireways shall be smooth and free from sharp edges.

Cords and wires shall be protected so that they do not come into contact with burrs, cooling fins or similar edges that may cause damage to their insulation.

Holes in metal through which cords and wires pass shall have smooth well-rounded surfaces or be provided with bushings.

Cords and wires shall be effectively prevented from coming into contact with moving parts.

Compliance is checked by inspection.

15.2 Bare wiring and heating elements shall be rigid and fixed so that during normal use **clearances** and **creepage distances** cannot be reduced below the values specified in Clause 18.

Compliance is checked by inspection and by measurement.

16 Components

16.1 Components shall comply with the safety requirements specified in the relevant IEC standards as far as they reasonably apply.

Compliance is checked by inspection and by the tests of 16.1.1 and 16.1.2.

NOTE Compliance with the IEC standard for the relevant component does not necessarily ensure compliance with the requirements of this standard.

16.1.1 *Switches and automatic controls carrying a current exceeding 3 A during the tests of 9.3 and 9.4 shall comply with Annex C. However, if they have been separately tested and found to comply with IEC 61058-1 or IEC 60730-1 respectively under the conditions occurring in the **toy** and for the number of cycles specified in Annex C, they may be used without further tests.*

NOTE There are no specific requirements for switches and automatic controls carrying a current up to 3 A.

16.1.2 *If components are marked with their operating characteristics, the conditions under which they are used in the **toy** shall be in accordance with these markings, unless otherwise specified.*

The testing of components that have to comply with other standards is, in general, carried out separately, according to the relevant standard.

*If the component is used within the limits of its marking, it is tested in accordance with the conditions occurring in the **toy**, the number of samples being that required by the relevant standard.*

When no IEC standard exists for the relevant component, when the component is not marked or is not used in accordance with its marking, it is tested under the conditions occurring in the toy. The number of samples is, in general, that required by a similar specification.

16.2 Toys shall not be fitted with

- **thermal cut-outs** that can be reset by a soldering operation;
- mercury switches.

Compliance is checked by inspection.

16.3 Transformers for toys shall comply with IEC 61558-2-7.

Compliance is checked by inspection.

NOTE The transformer is tested separately from the toy.

17 Screws and connections

17.1 Fixings, the failure of which may impair compliance with this standard and electrical connections shall withstand the mechanical stresses occurring during play.

Screws used for these purposes shall not be of metal that is soft or liable to creep, such as zinc or aluminium. If they are of insulating material they shall have a nominal diameter of at least 3 mm and they shall not be used for any electrical connection.

Screws used for electrical connections shall screw into metal.

Compliance is checked by inspection and by the following test.

Screws and nuts are tested if they are used for electrical connections or are likely to be tightened by the user.

The screws or nuts are tightened and loosened without jerking

- 10 times, for screws in engagement with a thread of insulating material;
- 5 times, for nuts and other screws.

Screws in engagement with a thread of insulating material are completely removed and re-inserted each time.

The test is carried out using a suitable screwdriver, spanner or key and by applying a torque as shown in Table 1.

Column I is applicable for metal screws without heads if the screw does not protrude from the hole when tightened.

Column II is applicable for other metal screws and for nuts and screws of insulating material.

Table 1 – Torque for testing screws and nuts

Nominal diameter of screw (outer thread diameter) mm	Torque Nm	
	I	II
⊠ 2,8 ^a ⊠	0,2	0,4
>2,8 and ≤3,0	0,25	0,5
>3,0 and ≤3,2	0,3	0,6
>3,2 and ≤3,6	0,4	0,8
>3,6 and ≤4,1	0,7	1,2
>4,1 and ≤4,7	0,8	1,8
>4,7 and ≤5,3	0,8	2,0
>5,3	-	2,5

⊠^a Screws having a diameter less than 2,8 mm are not tested ⊠

No damage impairing the further use of the fixings or electrical connections shall occur.

NOTE The shape of the blade of the test screwdriver is to fit the head of the screw.

17.2 Electrical connections carrying a current exceeding 0,5 A shall be constructed so that contact pressure is not transmitted through insulating material that is liable to shrink or to distort unless there is sufficient resiliency in the metallic parts to compensate for any possible shrinkage or distortion of the insulating material.

Compliance is checked by inspection.

NOTE Ceramic material is not considered liable to shrink or to distort.

18 Clearances and creepage distances

Clearances and creepage distances of functional insulation shall not be less than 0,5 mm.

Compliance is checked by measurement.

19 Resistance to heat and fire

19.1 External parts of non-metallic material enclosing electric parts, and parts of insulating material supporting electric parts, shall be sufficiently resistant to heat if the **toy** has a **working voltage** exceeding 12 V and a current exceeding 3 A.

NOTE 1 The voltage and current are measured during the test of 9.3.

NOTE 2 **Toys** having a lower **working voltage** or current are not considered to generate sufficient heat to create a hazard.

Compliance is checked by subjecting the relevant part to the ball pressure test of IEC 60695-10-2.

The test is carried out at a temperature of 40 °C ± 2 °C plus the maximum temperature rise determined during the tests of Clause 9 but it shall be at least 75 °C ± 2 °C.

NOTE 3 The test is only carried out on parts that could deteriorate to the extent that compliance with this standard is impaired.

NOTE 4 For coil formers, only those parts that support or retain terminals in position are subjected to the test.

NOTE 5 The test is not carried out on parts of ceramic material.

NOTE 6 The sequence of tests for resistance to heat is shown in Annex D.

19.2 Parts of non-metallic material enclosing electric parts, and parts of insulating material supporting electric parts, shall be resistant to ignition and spread of fire.

This requirement does not apply to decorative trims, knobs and other parts unlikely to be ignited or to propagate flames that originate from inside the **toy**.

Compliance is checked by the tests of 19.2.1 and 19.2.2.

*The tests are carried out on parts of non-metallic material that have been removed from the **toy**. When the glow-wire test is carried out, they are placed in the same orientation as they would be in normal use.*

These tests are not carried out on the insulation of cords and wires.

NOTE The sequence of tests for resistance to fire is shown in Annex D.

19.2.1 Parts of non-metallic material are subjected to the glow-wire test of IEC 60695-2-11, which is carried out at 550 °C.

The glow-wire test is not carried out on parts of material classified at least HB40 according to IEC 60695-11-10, provided that the test sample was no thicker than the relevant part.

Parts for which the glow-wire test cannot be carried out, such as those made of soft or foamy material, shall meet the requirements specified in ISO 9772 for category HBF material, the test sample being no thicker than the relevant part.

19.2.2 Parts of insulating material supporting connections carrying a current exceeding 3A and having a **working voltage** exceeding 12 V, and parts of insulating material within a distance of 3 mm of such connections, are subjected to the glow-wire test of IEC 60695-2-11 at a temperature of 650 °C. However, the glow-wire test is not carried out on parts of material classified as having a glow-wire ignition temperature according to IEC 60695-2-13 of at least 675 °C, provided that the test sample was no thicker than the relevant part.

NOTE 1 Contacts in components such as switch contacts are considered to be connections.

NOTE 2 The tip of the glow-wire is applied to the part in the vicinity of the connection.

Parts that withstand the glow-wire test of IEC 60695-2-11, but which, during the test, produce a flame that persists for longer than 2 s, are further tested as follows. Parts above the connection within the envelope of a vertical cylinder having a diameter of 20 mm and a height of 50 mm are subjected to the needle-flame test of Annex B. However, parts shielded by a barrier that meets the needle-flame test of Annex B are not tested.

The needle-flame test is not carried out on parts of material classified as V-0 or V-1 according to IEC 60695-11-10, provided that the test sample was no thicker than the relevant part.

20 **A1** Radiation, toxicity and similar hazards **A1**

Toys shall not present a toxic or similar hazard.

*Compliance is checked in accordance with **C** EN 71-3 **C**.*

NOTE **C** EN 71-3 **C** is not applicable to batteries.

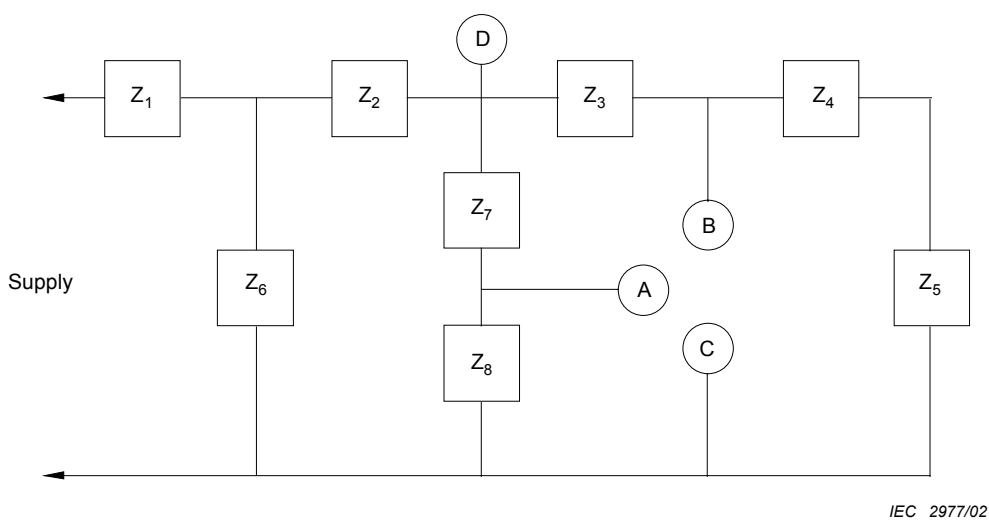

D is a point farthest from the supply source where the maximum power delivered to external load exceeds 15 W.
A and B are points closest to the supply source where the maximum power delivered to external load does not exceed 15 W. These are low-power points.
Points A and B are separately short-circuited to C.
The fault conditions a) to f) specified in 9.8.2 are applied individually to Z₁, Z₂, Z₃, Z₆ and Z₇ where applicable.

Figure 1 – Example of an electronic circuit with low-power points

Annex A (normative)

Experimental sets

The following modifications to this standard are applicable to all components of **experimental sets** supplied together or separately.

5 General conditions for the tests

5.10 Addition:

The tests are carried out with the experiments described in the instructions that result in the most unfavourable condition.

5.15 Not applicable

7 Marking and instructions

7.1 Addition:

The substance of the following shall be indicated on the packaging:

- WARNING: Only for use by children aged 8 years and older;
- NOTE An age higher than 8 years may be stated.
- instructions for parents are included and have to be observed.

7.4 Addition:

The instructions for parents shall state the minimum age of the child for whom the set is intended.

Detailed information shall be given in the instructions on how to set up and perform each experiment. The instructions shall point out possible hazards and give technical information concerning the electrical parts, their behaviour and how to handle them properly. All hazards that can be expected during an experiment, such as those resulting from the short-circuiting of batteries or the wrong connection of capacitors, shall be described in detail.

NOTE The instructions should be written so that they are understandable by the age group for which the experimental set is intended.

Instructions for children and for parents may be given separately. If the instructions are given in one leaflet, the section addressed to parents shall be given first.

The instructions shall include a warning against manipulation of protective devices such as current-limiting devices. They shall describe the consequential dangers, such as overheating of cords, eruption of batteries and excessive heating.

8 Power input

Not applicable.

9 Heating and abnormal operation

9.4 Not applicable.

9.6 Not applicable.

9.9 *Addition:*

The temperature rise of surfaces, other than those of handles, knobs, buttons and similar parts, can exceed the limits if an appropriate warning is given in the instructions.

11 Moisture resistance

Not applicable.

12 Electric strength at room temperature

Not applicable.

13 Mechanical strength

Not applicable.

14 Construction

14.1 *Addition:*

The current shall not exceed 5 A and the power input shall not exceed 50 VA. However these values may be exceeded during a period not exceeding 10 s.

Compliance is checked by measurement during the tests.

15 Protection of cords and wires

Not applicable.

Annex B (normative)

Needle-flame test

The needle-flame test is carried out in accordance with IEC 60695-2-2 with the following modifications.

5 Severities

Replacement:

The duration of application of the test flame is 30 s ± 1 s.

8 Test procedure

8.2 *Modification:*

The specimen is arranged so that the flame can be applied to a vertical or horizontal edge as shown in the examples of Figure 1.

8.4 *Modification:*

The first paragraph does not apply.

Addition:

If possible, the flame is applied at least 10 mm from a corner.

8.5 *Replacement:*

The test is carried out on one specimen. If the specimen does not withstand the test, the test may be repeated on two additional specimens, both of which shall then withstand the test.

10 Evaluation of test results

The duration of burning (t_b) shall not exceed 30 s. However, for printed-circuit boards, it shall not exceed 15 s.

Annex C (normative)

Automatic controls and switches

C.1 Automatic controls that are tested with the **toy** shall comply with this standard and with subclauses 11.3.5 to 11.3.8 and Clause 17 of IEC 60730-1 as type 1 controls.

*The tests according to IEC 60730-1 are carried out under the conditions occurring in the **toy**.*

For the tests of Clause 17 of IEC 60730-1, the number of cycles of operation are

– <i>thermostats</i>	<i>3 000</i>
– <i>self-resetting thermal cut-outs</i>	<i>300</i>
– <i>non-self-resetting thermal cut-outs</i>	<i>10</i>

NOTE 1 The tests of Clauses 12, 13 and 14 are not carried out before making the test of Clause 17 of IEC 60730.

NOTE 2 Automatic controls may be tested separately from the **toy**.

C.2 Switches that are tested with the **toy** shall comply with this standard and with the following clauses of IEC 61058-1, as modified below.

*The tests of IEC 61058-1 are carried out under the conditions occurring in the **toy**.*

Before being tested, switches are operated 20 times without load.

8 Marking and documentation

Switches are not required to be marked. However, a switch that can be tested separately from the appliance shall be marked with the manufacturer's name or trade mark and the type reference.

13 Mechanism

NOTE The tests may be carried out on a separate sample.

15 Insulation resistance and dielectric strength

Subclause 15.1 is not applicable.

Subclause 15.2 is not applicable.

Subclause 15.3 is applicable for full disconnection and micro-disconnection.

NOTE This test is carried out immediately after the humidity test of 11.2 of this standard.

17 Endurance

Compliance is checked on three separate appliances or switches.

For 17.2.4.4, the number of cycles of actuation declared according to 7.1.4 is 3 000.

Subclause 17.2.5.2 is not applicable.

At the end of the tests, the temperature rise of the terminals shall not have increased by more than 30 K above the temperature rise measured in Clause 9 of this standard.

20 Clearances, creepage distances, solid insulation and coatings of rigid printed board assemblies

This clause is applicable to **clearances** and **creepage distances** for **functional insulation**, across full disconnection and micro-disconnection, as stated in Table 24.

Annex D (informative)

Sequence of the tests of Clause 19

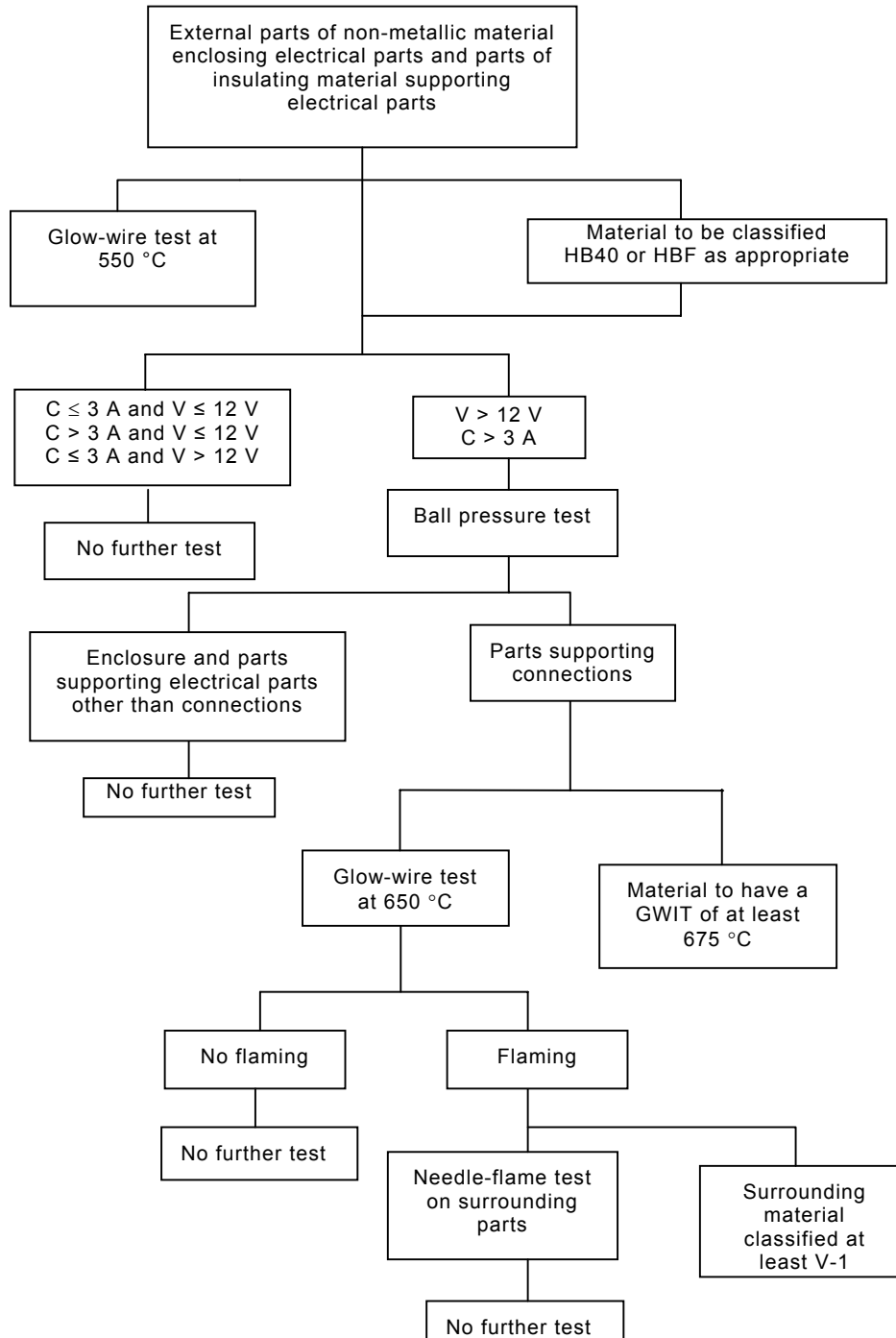

Annex E (normative)

Toys incorporating lasers and light-emitting diodes

The following modifications to this standard are applicable for **toys** incorporating **lasers** and **light-emitting diodes**.

3 Definitions

3.6

laser

device that can be made to produce or amplify electromagnetic radiation in the wavelength range from 180 nm to 1 mm, primarily by the process of controlled stimulated emission

3.7

light-emitting diode (LED)

semiconductor PN junction device that can be made to produce electromagnetic radiation by radiative recombination in the semiconductor in the wavelength range from 180 nm to 1 mm

NOTE The optical radiation is produced primarily by the process of spontaneous emission, but some stimulated emission may be present.

5 General conditions for the tests

5.2 The tests of this annex may be carried out on separate **toys** after the preconditioning of 5.15.

20 Radiation, toxicity and similar hazards

Toys shall not emit harmful radiation.

Lasers and **light-emitting diodes** in **toys** shall meet the requirements for Class 1 **lasers** in accordance with IEC 60825-1.

NOTE 101 Class 1 lasers do not include Class 1M lasers.

*Compliance is checked by inspection and by measuring the radiation under the conditions specified in IEC 60825-1, the **toy** being supplied at **rated voltage**. The measurement is also made with parts such as lenses, reflectors or filters, which could affect the focusing of the **laser** or **light-emitting diode**, removed, even if the **toy** has to be damaged. This measurement is carried out even if the relevant parts of the encapsulation, lenses, reflectors or filters are broken off during the preconditioning of 5.15. The fault conditions listed in 9.8.2 of this standard are taken into account when testing low-power circuits.*

NOTE 102 To avoid testing an **LED** in the **toy** under different abnormal conditions, the highest current of the **LED** is measured or calculated under the most unfavourable abnormal conditions and used to determine the light emission from data supplied for the **LED**. **Annex A1**

Annex ZA
(normative)

Normative references to international publications
with their corresponding European publications

The following referenced documents are indispensable for the application of this document. For dated references, only the edition cited applies. For undated references, the latest edition of the referenced document (including any amendments) applies.

NOTE When an international publication has been modified by common modifications, indicated by (mod), the relevant EN/HD applies.

<u>Publication</u>	<u>Year</u>	<u>Title</u>	<u>EN/HD</u>	<u>Year</u>
–	–	Safety of toys Part 1: Mechanical and physical properties	EN 71-1	1998
–	–	Safety of toys Part 3: Migration of certain elements	EN 71-3	1994
IEC 60068-2-75	– ¹⁾	Environmental testing Part 2-75: Tests - Test Eh: Hammer tests	EN 60068-2-75	1997 ²⁾
IEC 60083	– ¹⁾	Plugs and socket-outlets for domestic and similar general use standardized in member countries of IEC	-	-
IEC 60086-2	– ¹⁾	Primary batteries Part 2: Physical and electrical specifications	EN 60086-2	2001 ²⁾
IEC 60320-1	– ¹⁾	Appliance couplers for household and similar general purposes Part 1: General requirements	EN 60320-1	2001 ²⁾
IEC 60384-14	– ¹⁾	Fixed capacitors for use in electronic equipment Part 14: Sectional specification: Fixed capacitors for electromagnetic interference suppression and connection to the supply mains	-	-
IEC 60417-1	– ³⁾	Graphical symbols for use on equipment Part 1: Overview and application	–	–
IEC 60529	1989	Degrees of protection provided by enclosures (IP Code)	EN 60529 + corr. May	1991 1993
IEC 60695-2-2	1991	Fire hazard testing Part 2: Test methods Section 2: Needle-flame test	EN 60695-2-2	1994

1) Undated reference.

2) Valid edition at date of issue.

3) Superseded by IEC 60417 database.

<u>Publication</u>	<u>Year</u>	<u>Title</u>	<u>EN/HD</u>	<u>Year</u>
IEC 60695-2-11	– ¹⁾	Part 2-11: Glowing/hot-wire based test methods - Glow-wire flammability test method for end-products	EN 60695-2-11	2001 ²⁾
IEC 60695-2-13	– ¹⁾	Part 2-13: Glowing/hot-wire based test methods - Glow-wire ignitability test method for materials	EN 60695-2-13	2001 ²⁾
IEC 60695-10-2	– ¹⁾	Part 10-2: Abnormal heat - Ball pressure test	EN 60695-10-2	2003 ²⁾
IEC 60695-11-10	– ¹⁾	Part 11-10: Test flames - 50 W horizontal and vertical flame test methods	EN 60695-11-10	1999 ²⁾
IEC 60730-1 (mod)	1999	Automatic electrical controls for household and similar use Part 1: General requirements	EN 60730-1 A11 A12	2000 2002 2003
IEC 60738-1	– ¹⁾	Thermistors - Directly heated positive step-function temperature coefficient Part 1: Generic specification	EN 60738-1	1999 ²⁾
IEC 60825-1 A1 A2 corr. 1	1993 1997 2001 2002	Safety of laser products Part 1: Equipment classification, requirements and user's guide	EN 60825-1 + corr. February A1 A2 + corr. April	1994 1995 2002 2001 2004
IEC 61032	1997	Protection of persons and equipment by enclosures - Probes for verification	EN 61032	1998
IEC 61058-1 (mod)	2000	Switches for appliances Part 1: General requirements	EN 61058-1	2002 ⁴⁾
IEC 61558-2-7 (mod)	– ¹⁾	Safety of power transformers, power supply units and similar Part 2-7: Particular requirements for transformers for toys	EN 61558-2-7 A11	1997 ²⁾ 2002
ISO 7000	– ¹⁾	Graphical symbols for use on equipment - Index and synopsis	–	–
ISO 9772	– ¹⁾	Cellular plastics - Determination of horizontal burning characteristics of small specimens subjected to a small flame	–	–

4) EN 61058-1 includes A1:2001 to IEC 61058-1:2000.

**Annex ZZ
(informative)**

Coverage of Essential Requirements of EC Directives

This European Standard has been prepared under a mandate given to CENELEC by the European Commission and the European Free Trade Association and within its scope the standard covers all relevant essential requirements as given in Annex II of the EC Directive 88/378/EEC.

Compliance with this standard provides one means of conformity with the specified essential requirements of the Directive concerned.

WARNING: Other requirements and other EC Directives may be applicable to the products falling within the scope of this standard.

Bibliography

IEC 60335-2-82, *Household and similar electrical appliances – Safety – Part 2-82: Particular requirements for amusement machines and personal service machines*

IEC 60598-2-10, *Luminaires – Part 2: Particular requirements – Section Ten: Portable child-appealing luminaires*

BSI — British Standards Institution

BSI is the independent national body responsible for preparing British Standards. It presents the UK view on standards in Europe and at the international level. It is incorporated by Royal Charter.

Revisions

British Standards are updated by amendment or revision. Users of British Standards should make sure that they possess the latest amendments or editions.

It is the constant aim of BSI to improve the quality of our products and services. We would be grateful if anyone finding an inaccuracy or ambiguity while using this British Standard would inform the Secretary of the technical committee responsible, the identity of which can be found on the inside front cover.
Tel: +44 (0)20 8996 9000. Fax: +44 (0)20 8996 7400.

BSI offers members an individual updating service called PLUS which ensures that subscribers automatically receive the latest editions of standards.

Buying standards

Orders for all BSI, international and foreign standards publications should be addressed to Customer Services. Tel: +44 (0)20 8996 9001.
Fax: +44 (0)20 8996 7001. Email: orders@bsi-global.com. Standards are also available from the BSI website at <http://www.bsi-global.com>.

In response to orders for international standards, it is BSI policy to supply the BSI implementation of those that have been published as British Standards, unless otherwise requested.

Information on standards

BSI provides a wide range of information on national, European and international standards through its Library and its Technical Help to Exporters Service. Various BSI electronic information services are also available which give details on all its products and services. Contact the Information Centre.
Tel: +44 (0)20 8996 7111. Fax: +44 (0)20 8996 7048. Email: info@bsi-global.com.

Subscribing members of BSI are kept up to date with standards developments and receive substantial discounts on the purchase price of standards. For details of these and other benefits contact Membership Administration.
Tel: +44 (0)20 8996 7002. Fax: +44 (0)20 8996 7001.
Email: membership@bsi-global.com.

Information regarding online access to British Standards via British Standards Online can be found at <http://www.bsi-global.com/bsonline>.

Further information about BSI is available on the BSI website at <http://www.bsi-global.com>.

Copyright

Copyright subsists in all BSI publications. BSI also holds the copyright, in the UK, of the publications of the international standardization bodies. Except as permitted under the Copyright, Designs and Patents Act 1988 no extract may be reproduced, stored in a retrieval system or transmitted in any form or by any means – electronic, photocopying, recording or otherwise – without prior written permission from BSI.

This does not preclude the free use, in the course of implementing the standard, of necessary details such as symbols, and size, type or grade designations. If these details are to be used for any other purpose than implementation then the prior written permission of BSI must be obtained.

Details and advice can be obtained from the Copyright & Licensing Manager.
Tel: +44 (0)20 8996 7070. Fax: +44 (0)20 8996 7553.
Email: copyright@bsi-global.com.