

Reference design: wide range 200W L6599-based HB LLC resonant converter for LCD TV & flat panels

Introduction

This note describes the performances of a 200W reference board, with wide-range mains operation and power-factor-correction (PFC). Its electrical specification is tailored to a typical high-end application for LCD TV or monitor applications.

The main features of this design are the very low no-load input consumption (<0.5W) and the very high global efficiency, better than 87% at full load and nominal mains voltage (115 - 230 V_{AC}).

The circuit consists of three main blocks; the first is a front-end PFC pre-regulator based on the L6563 PFC controller. The second stage is a multi-resonant half-bridge converter whose control is implemented through the STMicroelectronics L6599 resonant controller. A further auxiliary flyback converter based on the Viper12A off-line primary switcher completes the architecture. This third block is mainly intended for microprocessor supply and display power management operations.

L6599 and L6563 200W Evaluation board (EVAL6599-200W)



Contents

- 1 Main characteristics and circuit description 5**
- 2 Electrical test results 10**
 - 2.1 Efficiency measurements 10
 - 2.2 Resonant stage operating waveforms 12
 - 2.3 Stand-by and no load power consumption 15
 - 2.4 Short-circuit protection 16
 - 2.5 Overvoltage protection 17
- 3 Thermal tests 18**
- 4 Conducted emission pre-compliance test 21**
- 5 Bill of materials 22**
- 6 PFC coil specification 28**
 - 6.1 Electrical characteristics 28
 - 6.2 Mechanical aspect and pin numbering 28
- 7 Resonant power transformer specification 30**
 - 7.1 Electrical characteristics and mechanical aspect 30
- 8 Auxiliary flyback power transformer 32**
 - 8.1 Electrical characteristics 32
- 9 Reference design board layout 34**
- 10 Revision history 36**

List of tables

Table 1.	Efficiency measurements @VIN = 115 VAC.....	10
Table 2.	Efficiency measurements @VIN = 230 VAC.....	10
Table 3.	Stand-by consumption at VIN = 115 VAC.....	16
Table 4.	Stand-by consumption at VIN = 230 VAC.....	16
Table 5.	Key components temperature at 115 VAC - full load	19
Table 6.	Key components temperature at 230 VAC - full load	20
Table 7.	Bill of materials	22
Table 8.	PFC coil winding characteristics	28
Table 9.	Resonant transformer dimensions	30
Table 10.	Resonant transformer winding characteristics	31
Table 11.	Auxiliary transformer winding characteristics	33
Table 12.	Revision history	36

List of figures

Figure 1.	Auxiliary converter electrical diagram	7
Figure 2.	PFC pre-regulator electrical diagram	8
Figure 3.	Resonant converter electrical diagram	9
Figure 4.	Overall efficiency versus output power at nominal mains voltages.	11
Figure 5.	Overall efficiency versus output power at several input voltage values	12
Figure 6.	Resonant circuit primary side waveforms at full load	13
Figure 7.	Resonant circuit primary side waveforms at no-load condition.	13
Figure 8.	Resonant circuit secondary side waveforms: +24V output	14
Figure 9.	Resonant circuit secondary side waveforms: +12V output	14
Figure 10.	Low frequency (100Hz) ripple voltage on the output voltages	14
Figure 11.	Load transition (0 - 100%) on +24V output voltage	15
Figure 12.	Load transition (0 - 100%) on +12V output voltage	15
Figure 13.	+24V output short-circuit waveforms	17
Figure 14.	+12V output short-circuit waveforms	17
Figure 15.	Thermal map @ 115Vac - full load	18
Figure 16.	Thermal map at 230 Vac - full load	18
Figure 17.	CE quasi peak measurement at 115 VAC and full load	21
Figure 18.	CE quasi peak measurement at 230 VAC and full load	21
Figure 19.	PFC coil electrical diagram	28
Figure 20.	PFC coil pin side view.	29
Figure 21.	Mechanical aspect and pin numbering of resonant transformer.	30
Figure 22.	Resonant transformer electrical diagram	31
Figure 23.	Resonant transformer winding position on coil former	31
Figure 24.	Auxiliary transformer electrical diagram	32
Figure 25.	Auxiliary transformer winding position on coil former	33
Figure 26.	Copper tracks	34
Figure 27.	Thru-hole component placing and top silk screen	35
Figure 28.	SMT component placing and bottom silk screen	35

1 Main characteristics and circuit description

The main characteristics of the SMPS are listed below:

- Universal input mains range: 90 to 264 V_{AC} and frequencies between 45 and 65 Hz
- Output voltages:
 - 24V@6A continuous operation
 - 12V@ 5A continuous operation
 - 3.3V@ 0.7A continuous operation
 - 5V@ 1A continuous operation
- Mains harmonics: Compliance with EN61000-3-2 specifications
- St-by mains consumption: Typical 0.5W @230 V_{AC}
- Overall efficiency: better than 88% at full load
- EMI: Compliance with EN55022-class B specifications
- Safety: Compliance with EN60950 specifications
- PCB single layer: 132x265 mm, mixed PTH/SMT technologies

The circuit consists of three stages. A front-end PFC pre-regulator implemented by the controller L6563 ([Figure 1](#)), a half-bridge resonant DC/DC converter based on the resonant controller L6599 ([Figure 2](#)) and a 7W flyback converter intended for stand-by management ([Figure 3](#)) utilizing the ViPer12A off-line primary switcher.

The PFC stage delivers a stable 400 V_{DC} supply and provides for the reduction of the mains harmonics, in order to meet the requirements of the European norm EN61000-3-2 and the JEIDA-MITI norm for Japan.

The PFC controller is the L6563 (U1), working in FOT (fixed off-time) mode and integrating all functions needed to operate the PFC and interface the downstream resonant converter.

Note: The FOT control is implemented through components C15, C17, D5, Q3, R14, R17 and R29 (see AN1792 for a complete description of a FOT PFC pre-regulator).

The power stage of the PFC is a conventional boost converter, connected to the output of the rectifier bridge through a differential mode filtering cell (C5, C6 and L3) for EMI reduction. It includes a coil (L4), diode (D3) and two capacitors (C7 and C8).

The boost switch is represented by the power MOSFET (Q2) which is directly driven by the L6563 output drive thanks to the high current capability of the IC.

The divider (R30, R31 and R32) provides the L6563 (MULT Pin 3) with the information of the instantaneous voltage that is used to modulate the boost current and to derive some further information like the average value of the AC line used by the V_{FF} (voltage feed-forward) function. This function is used to keep the output voltage almost independent of the mains one.

The first divider (R3, R6, R8, R10 and R11) is dedicated to detecting the output voltage while the second divider (R5, R7, R9, R16 and R25) is used to protect the circuit in case of voltage loop fail.

The second stage is an LLC resonant converter, with half bridge topology, working in ZVS (zero voltage switching) mode.

The controller is the L6599 integrated circuit that incorporates the necessary functions to drive properly the two half-bridge MOSFETs by a 50 percent fixed duty cycle with dead-time,

changing the frequency according to the feedback signal in order to regulate the output voltages against load and input voltage variations.

The main features of the L6599 are a non-linear soft-start, a current protection mode used to program the hiccup mode timing, a dedicated pin for sequencing or brown-out (LINE) and a stand-by pin (STBY) for burst mode operation at light loads (not used in this design).

The transformer uses the magnetic integration approach, incorporating the resonant series and shunt inductances. Thus, no additional external coils are needed for the resonance. The transformer configuration chosen for the secondary winding is center-tap, and the output rectifiers are Schottky type diodes, in order to limit the power dissipation. The feedback loop is implemented by means of a classical configuration using a TL431 (U4) to adjust the current in the optocoupler diode (U3). A weighted resistive divider (R53, R57, R58, R60 and R61) is used to detect both output voltages in order to get a better overall voltage regulation. The optocoupler transistor modulates the current from Pin 4, so the frequency will change accordingly, thus achieving the output voltage regulation. Resistors R46 and R54 set the maximum operating frequency.

In case of a short circuit, the current entering the primary winding is detected by the lossless circuit (C34, C39, D11, D12, R43, and R45) and the resulting signal is fed into Pin 6.

In case of overload, the voltage on Pin 6 will overpass an internal threshold that triggers a protection sequence via Pin 2, keeping the current flowing in the circuit at a safe level.

The third stage is a small flyback converter based on the VIPER12A, a current mode controller with integrated power MOSFET, capable of delivering (approximately) 7 W output power on the output voltages (5V and 3.3V). The regulated output voltage is the 3.3V output and, also in this case, the feedback loop bases on the TL431 (U7) and optocoupler (U6) to control the output voltage.

This converter is able to operate in the whole mains voltage range, even when the PFC stage is not working. From the auxiliary winding on the primary side of the flyback transformer (T2), a voltage V_s is available, intended to supply the other controllers (L6563 and L6599) in addition to the VIPER12A itself.

The PFC stage and the resonant converter can be switched on and off through the circuit based mainly on components Q7, Q8, D22 and U8, which, depending on the level of the signal ST-BY, supplies or removes the auxiliary voltage (V_{AUX}) necessary to start-up the controllers of the PFC and resonant stages. In this way, when the AC input voltage is applied to the power supply, the small flyback converter switches on first; then, when the ST-BY signal is high, the PFC pre-regulator becomes operative, and last the resonant converter can deliver the output power to the load.

Note that if Pin 9 of Connector J3 is left floating (no signal ST-BY present), the PFC and resonant converter will be not operating, and only +5V and +3.3V supplies are available on the output. In order to enable the +24V and +12V outputs, Pin 9 of Connector J3 must be pulled down to ground.

Figure 1. Auxiliary converter electrical diagram

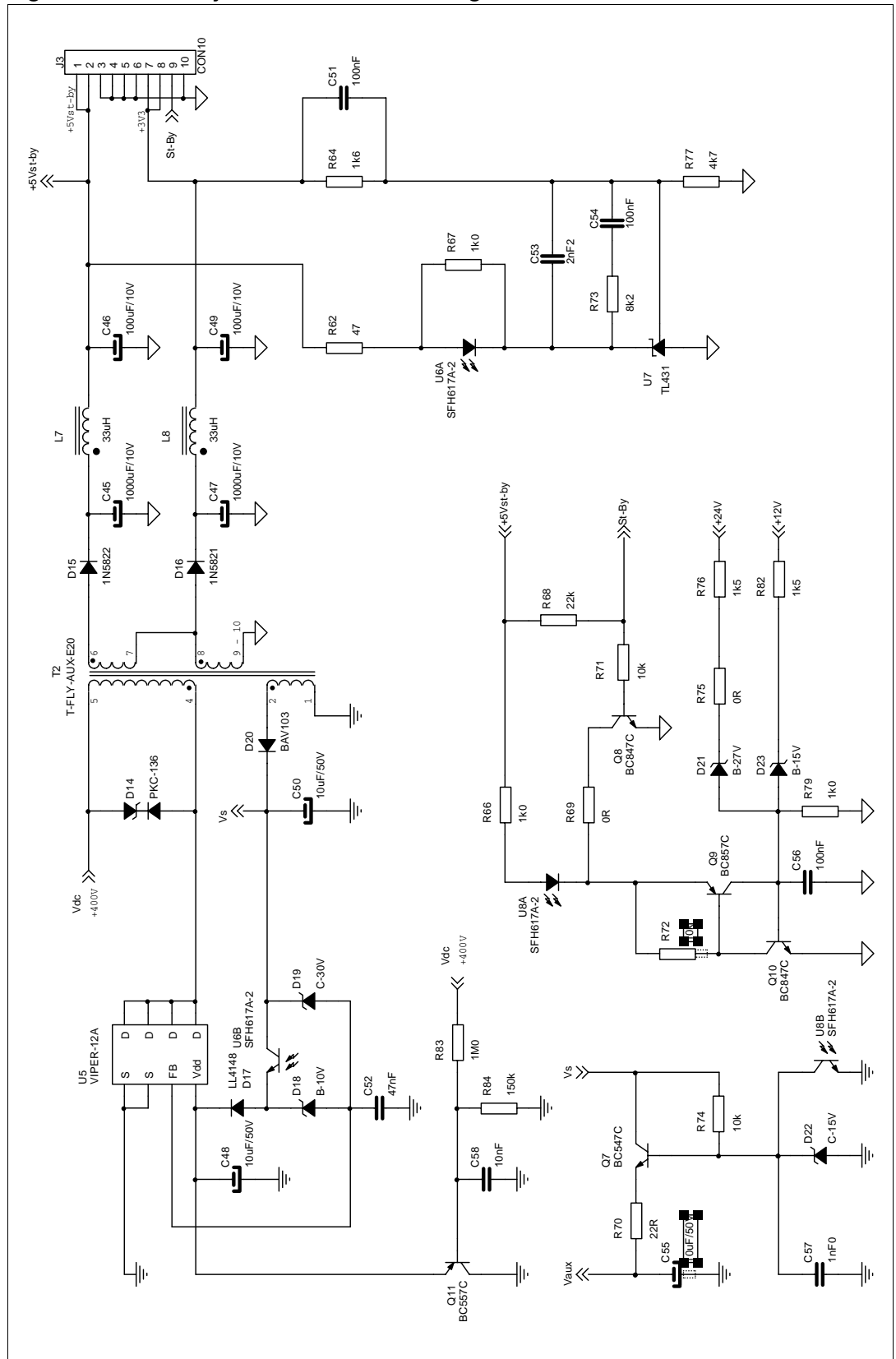
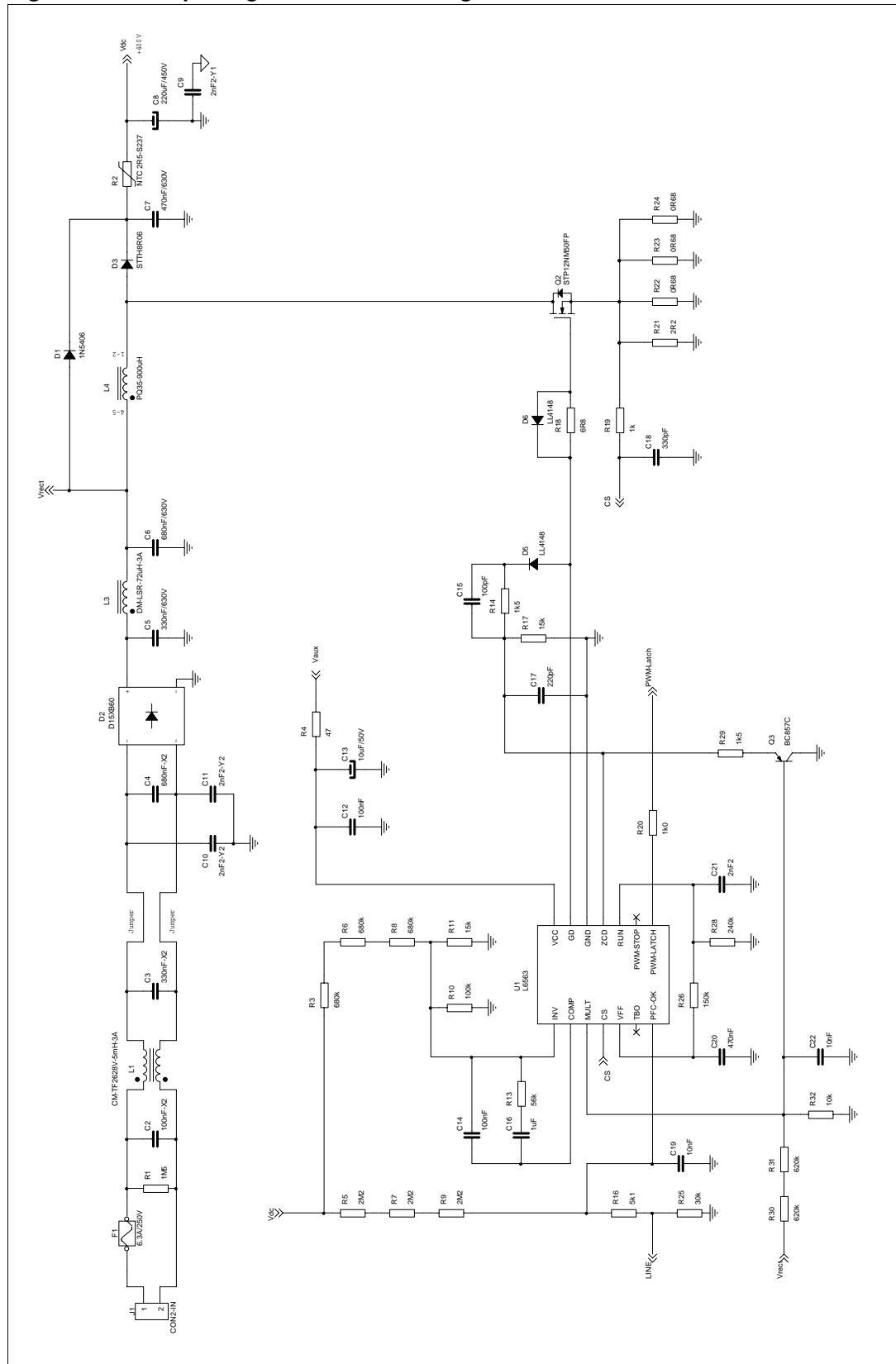

Figure 2. PFC pre-regulator electrical diagram



2 Electrical test results

2.1 Efficiency measurements

[Table 1](#) and [Table 2](#) show the output voltage measurements at the nominal mains voltages of 115 V_{AC} and 230 V_{AC}, with different load conditions. For all measurements, both at full load and at light load operation, the input power is measured using a Yokogawa WT-210 digital power meter.

Particular attention has to be paid when measuring input power at full load in order to avoid measurement errors due to the voltage drop on cables and connections. Therefore please connect the WT210 voltmeter termination to the board input connector. For the same reason please measure the output voltage at the output connector or use the remote sense option of your active load for a correct output voltage measurement.

Table 1. Efficiency measurements @V_{IN} = 115 V_{AC}

+24V(V) @load(A)	+12V(V) @load(A)	+5V(V) @load(A)	+3.3V(V) @load(A)	P _{OUT} (W)	P _{IN} (W)	Efficiency
23.81 - 6.00	11.86 - 4.94	4.93 - 0.98	3.35 - 0.71	208.66	235.00	88.79%
24.04 - 3.04	11.80 - 4.91	4.93 - 0.98	3.35 - 0.71	138.23	155.50	88.89%
23.84 - 3.02	11.91 - 1.98	4.93 - 0.98	3.35 - 0.71	102.79	115.47	89.02%
23.79 - 2.01	11.96 - 0.49	4.96 - 0.31	3.35 - 0.31	56.25	63.55	88.52%
23.94 - 0.53	11.92 - 0.49	4.97 - 0.31	3.35 - 0.31	21.11	25.56	82.58%

Table 2. Efficiency measurements @V_{IN} = 230 V_{AC}

+24V(V) @load(A)	+12V(V) @load(A)	+5V(V) @load(A)	+3.3V(V) @load(A)	P _{OUT} (W)	P _{IN} (W)	Efficiency
23.82 - 6.00	11.86 - 4.94	4.94 - 0.98	3.35 - 0.71	208.73	229.96	90.77%
24.05 - 3.04	11.80 - 4.91	4.94 - 0.98	3.35 - 0.71	138.27	152.85	90.46%
23.85 - 3.02	11.91 - 1.98	4.94 - 0.98	3.35 - 0.71	102.83	114.05	90.16%
23.80 - 2.01	11.96 - 0.49	4.96 - 0.31	3.35 - 0.31	56.27	63.47	88.66%
23.94 - 0.53	11.92 - 0.49	4.96 - 0.31	3.35 - 0.31	21.11	26.47	79.73%

In [Table 1](#), [Table 2](#) and [Figure 4](#) the overall circuit efficiency is measured at each load condition, at both nominal input mains voltages of 115 V_{AC} and 230 V_{AC}. The values were measured after 30 minutes of warm-up at maximum load. The high efficiency of the PFC pre-regulator working in FOT mode and the very high efficiency of the resonant stage working in ZVS (i.e. with negligible switching losses), provides for an overall efficiency better than 88%. This is a significant high value for a two-stage converter with two output voltages delivering an output current in excess of 5 amps, especially at low input mains voltage where the PFC conduction losses increase. Even at lower loads, the efficiency still remains high.

The global efficiency at full load has been measured even at the limits of the input voltage range, with good results:

- At $V_{IN} = 90 V_{AC}$ - full load, the efficiency is 86.88% ($P_{OUT} = 208.8 W$ and $P_{IN} = 240.3 W$)
- At $V_{IN} = 264 V_{AC}$ - full load, the efficiency is 90.90% ($P_{OUT} = 208.7 W$ and $P_{IN} = 229.6 W$)

Also at light load, at an output power of about 10% of the maximum level, the overall efficiency is very good, reaching a value better than 79% over the entire input mains voltage range.

Figure 5 shows the efficiency measured at various input voltages versus output power.

Figure 4. Overall efficiency versus output power at nominal mains voltages

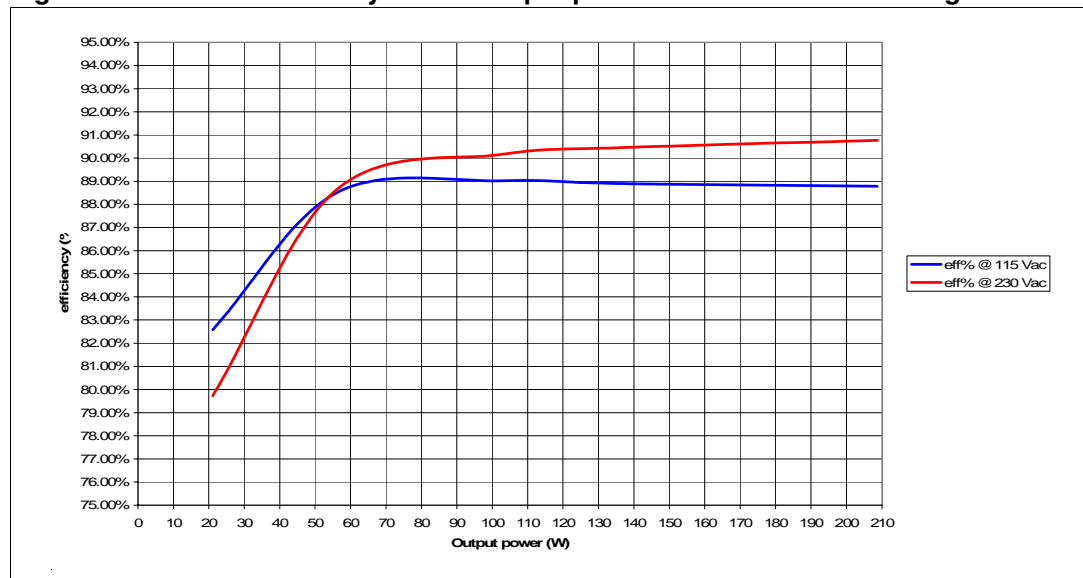
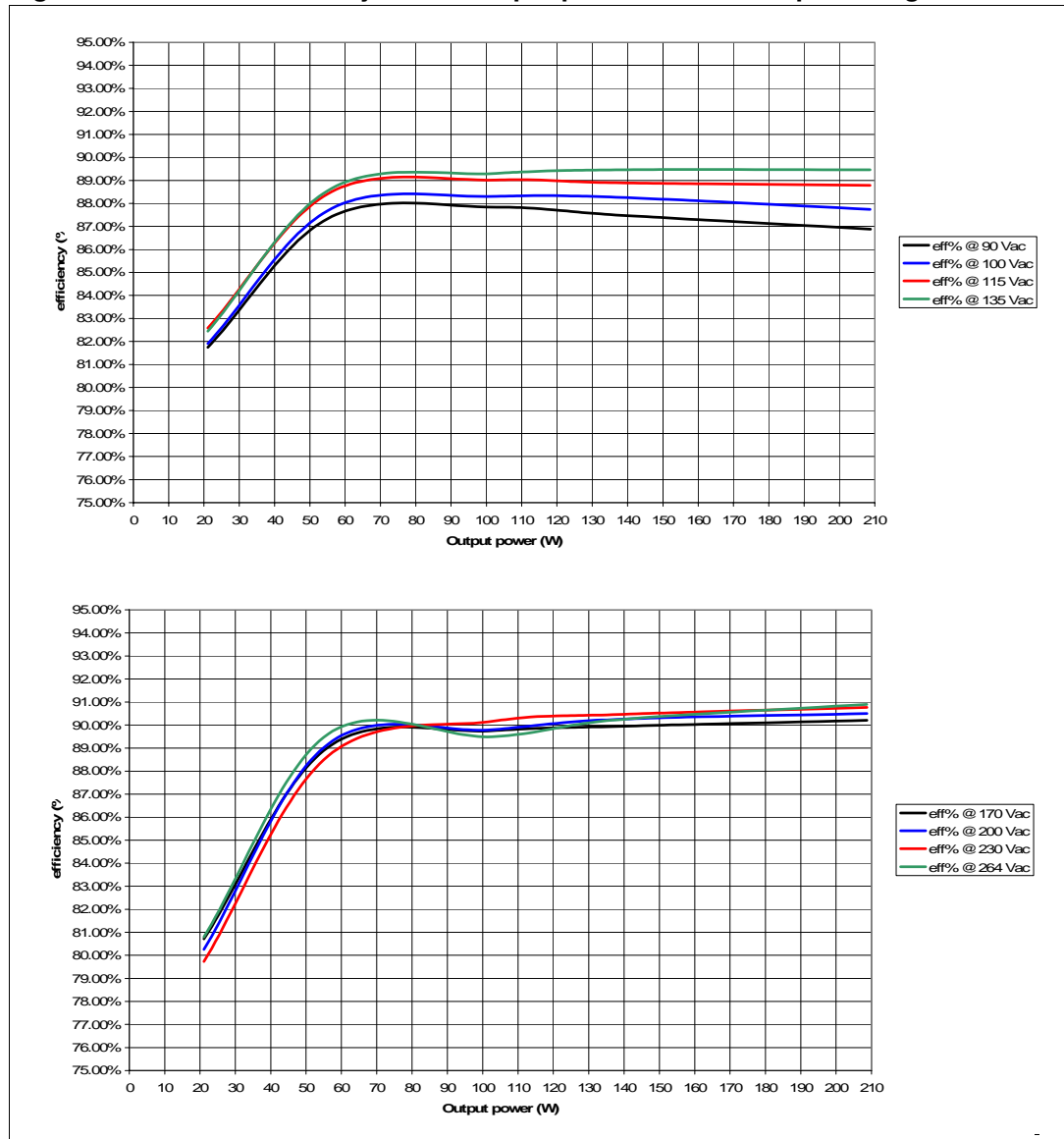

Figure 5. Overall efficiency versus output power at several input voltage values



2.2 Resonant stage operating waveforms

Figure 6 shows some waveforms during steady state operation of the resonant circuit at full load. The Ch3 waveform is the half-bridge square voltage on Pin 14 of L6599, driving the resonant circuit. In the picture it is not evident, but the switching frequency is normally slightly modulated following the PFC pre-regulator 100-Hz ripple that is rejected by the resonant control circuitry. The switching frequency has been selected approximately at 95-kHz in order to have a good trade off between transformer losses and dimensions.

The Ch4 waveform represents the transformer primary current flowing into the resonant tank. As shown, it is almost sinusoidal because the operating frequency is close to the resonance of the leakage inductance of the transformer and the resonant capacitor (C28). In this condition, the circuit has a good margin for ZVS operation, providing good efficiency,

while the almost sinusoidal current waveform just allows for an extremely low EMI generation.

Figure 7 shows the same waveforms of previous figure, when both the outputs are not loaded. This picture demonstrates the ability of the converter to operate down to zero load, with the output voltages still within regulation. The resonant tank current has obviously a triangular shape and represents the magnetizing current flowing into the transformer primary side.

Figure 6. Resonant circuit primary side waveforms at full load

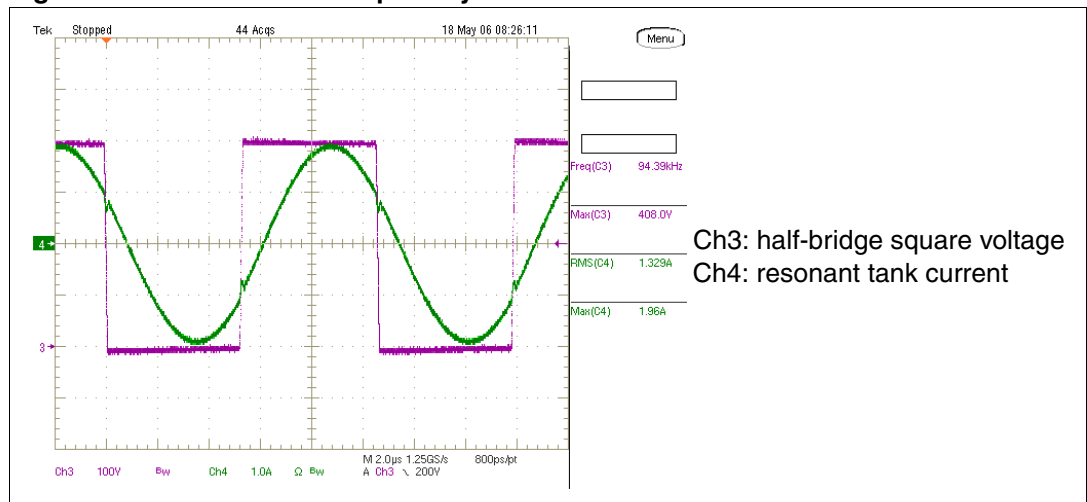
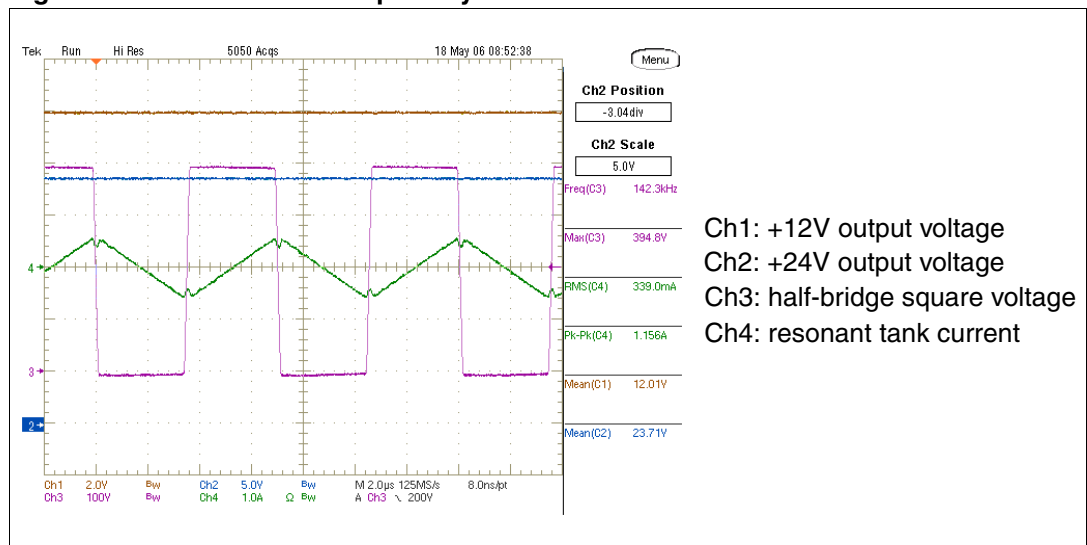

Figure 7. Resonant circuit primary side waveforms at no-load condition



In Figure 8 and Figure 9, waveforms relevant to the secondary side are represented: the rectifiers reverse voltage is measured by CH1 (for both +24V and +12V outputs) and the peak to peak value is indicated on the right side of the figure. It is a bit higher than the theoretical value that would be $2(V_{OUT}+V_F)$: it is possible to observe a small ringing on the bottom side of the waveform, responsible for this difference.

Waveform CH3 shows the current flowing into one of the two output diodes for each output voltage (respectively D8A and D10A). Also this current shape is almost a sine wave, whose average value is one half the output current.

The ripple and noise on the output voltage is shown on CH2. Thanks to the advantages of the resonant converter, the high frequency noise of the output voltages is less than 50mV, while the residual ripple at twice the mains frequency is lower than 75mV at maximum load and any line condition, as shown in *Figure 10*.

Figure 8. Resonant circuit secondary side waveforms: +24V output

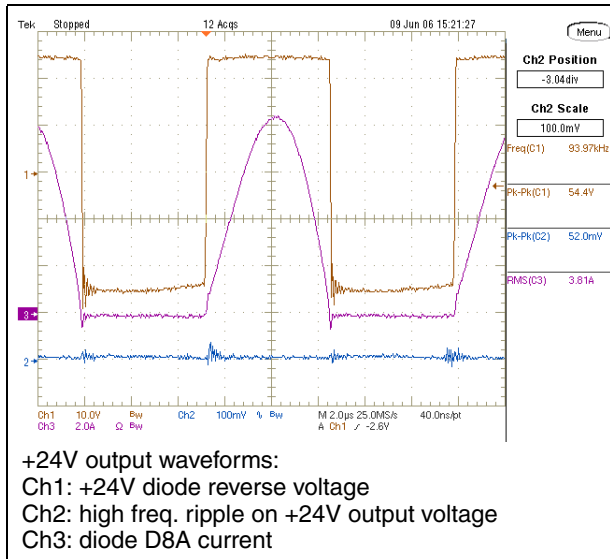

Figure 9. Resonant circuit secondary side waveforms: +12V output

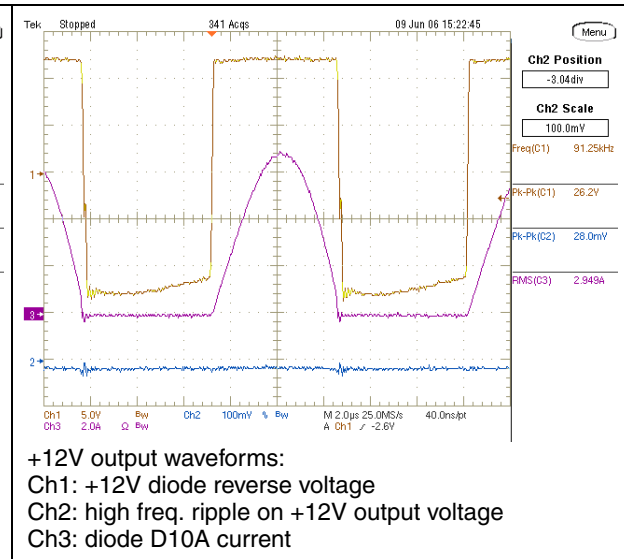

Figure 10. Low frequency (100Hz) ripple voltage on the output voltages

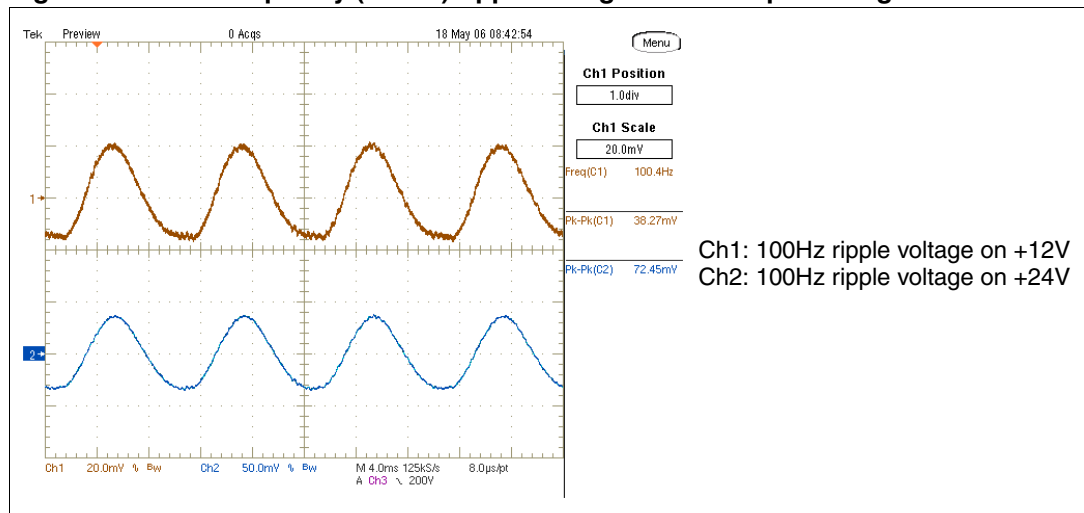

Figure 11 shows the dynamic behavior of the converter during a load variation from 0 to 100% on one output, with the other output at maximum load. This figure also highlights the induced effect of this load change on the PFC pre-regulator output voltage (+400V on Ch3 track). Both the transitions (from 0 to 100% and from 100% to 0) are clean and do not show any problem for the output voltage regulation.

Thus, it is clear that the proposed architecture is really suitable for power supplies operating with strong load variation without any problem related to the load regulation.

Figure 11. Load transition (0 - 100%) on +24V output voltage

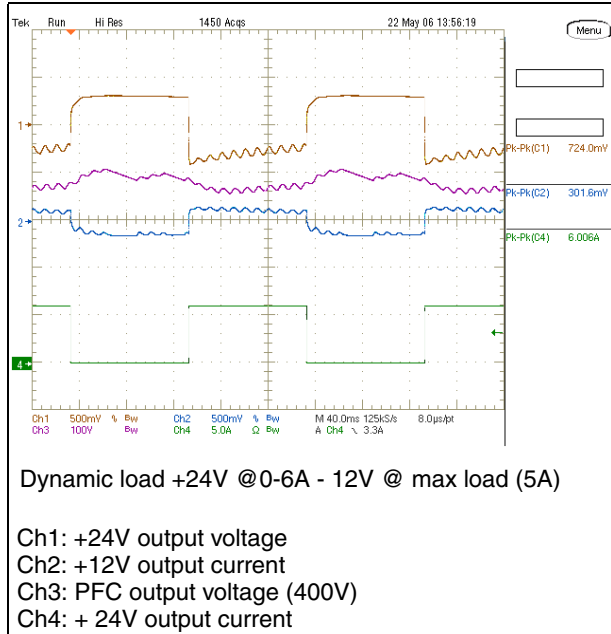
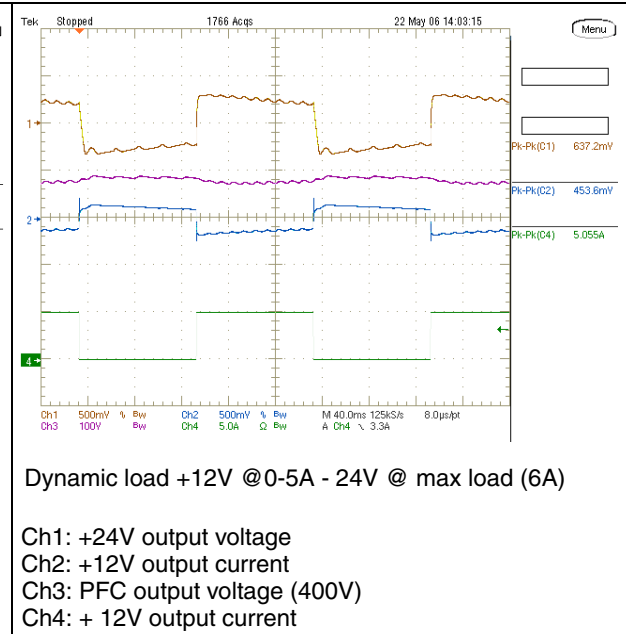

Figure 12. Load transition (0 - 100%) on +12V output voltage



2.3 Stand-by and no load power consumption

The board is specifically designed for light load and zero load operation, as during Stand-by or Power-off operation, when no power is requested from the +24V and +12V outputs.

Though the resonant converter can operate down to zero load, some tricks are required to keep very low the input power drawn from the mains when the system is in this load condition. Thus, when entering this power management mode, the ST-BY signal needs to be set high (by the microcontroller of the system). This forces the PFC pre-regulator and the resonant stage to switch off (because the supply voltage of the two control ICs is no longer present (*Figure 1*) and only the auxiliary flyback converter continues working just to supply the microprocessor circuitry.

Table 3 and *Table 4* show the measurements of the input power in several light load conditions at 115 and 230 V_{AC}.

These tables show that at no load the input power is lower than 0.5W.

Table 3. Stand-by consumption at $V_{IN} = 115 V_{AC}$

+5V(V) @load(A)	+3.3V(V) @load(A)	P _{OUT} (W)	P _{IN} (W)
5.08 - 0.018	3.35 - 0.102	0.43	0.863
5.04 - 0.018	3.35 - 0.079	0.36	0.751
4.98 - 0.018	3.35 - 0.046	0.24	0.582
4.92 - 0.018	3.35 - 0.023	0.17	0.445
4.47 - 0.000	3.35 - 0.000	0.00	0.221

Table 4. Stand-by consumption at $V_{IN} = 230 V_{AC}$

+5V(V) @load(A)	+3.3V(V) @load(A)	P _{OUT} (W)	P _{IN} (W)
5.08 - 0.018	3.35 - 0.102	0.43	1.138
5.04 - 0.018	3.35 - 0.079	0.36	1.022
4.98 - 0.018	3.35 - 0.046	0.24	0.857
4.92 - 0.018	3.35 - 0.023	0.17	0.740
4.47 - 0.000	3.35 - 0.000	0.00	0.470

2.4 Short-circuit protection

The L6599 is equipped with a current sensing input (pin #6, ISEN) and a dedicated over-current management system. The current flowing in the circuit is detected (through the not dissipative sensing circuit already mentioned in [Section 1](#) and the signal is fed into the ISEN pin. It is internally connected to the input of a first comparator, referenced to 0.8V, and to that of a second comparator referenced to 1.5V. If the voltage externally applied to the pin exceeds 0.8V, the first comparator is tripped causing an internal switch to be turned on discharging the soft-start capacitor CSS.

For output short-circuits, this operation results in a nearly constant peak primary current. Using the L6599, the designer can externally program the maximum time (t_{SH}) that the converter is allowed to run overloaded or under short-circuit conditions. Overloads or short-circuits lasting less than t_{SH} will not cause any other action, hence providing the system with immunity to short duration phenomena. If, instead, t_{SH} is exceeded, an overload protection (OLP) procedure is activated that shuts down the L6599 and, in case of continuous overload/short circuit, results in continuous intermittent operation with a user-defined duty cycle. This function is realized with the pin DELAY (#2), by means of a capacitor C24 and the parallel resistor R37 connected to ground. As the voltage on the ISEN pin exceeds 0.8V, the first OCP comparator, in addition to discharging CSS, turns on an internal current generator that via the DELAY pin charges C24. As the voltage on C24 reaches 3.5V, the L6599 stops switching and the PFC_STOP pin is pulled low. Also the internal generator is turned off, so that C24 will now be slowly discharged by R37. The IC will restart when the voltage on C24 becomes less than 0.3V. Additionally, if the voltage on the ISEN pin reaches 1.5V for any reason (e.g. transformer saturation), the second comparator will be triggered, the L6599 will shutdown and the operation will be resumed after an on-off cycle.

[Figure 13](#) and [Figure 14](#) illustrate the L6599 short-circuit protection sequence described above. The on-off operation is controlled by the voltage on pin #2 (DELAY), providing for the hiccup mode of the circuit. Thanks to this control pin, the designer can select the hiccup mode timing and thus keep the average output current at a safe level. Please note on the left

side of the figure the very low mean current flowing in the shorted output which is less than 0.3 A.

Figure 13. +24V output short-circuit waveforms

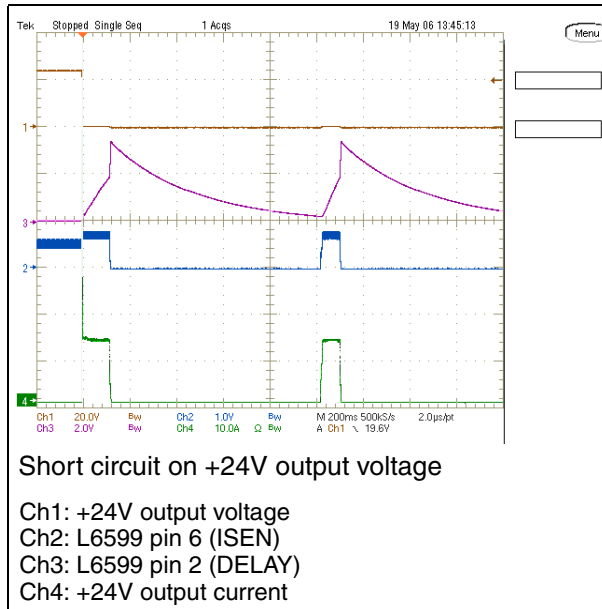
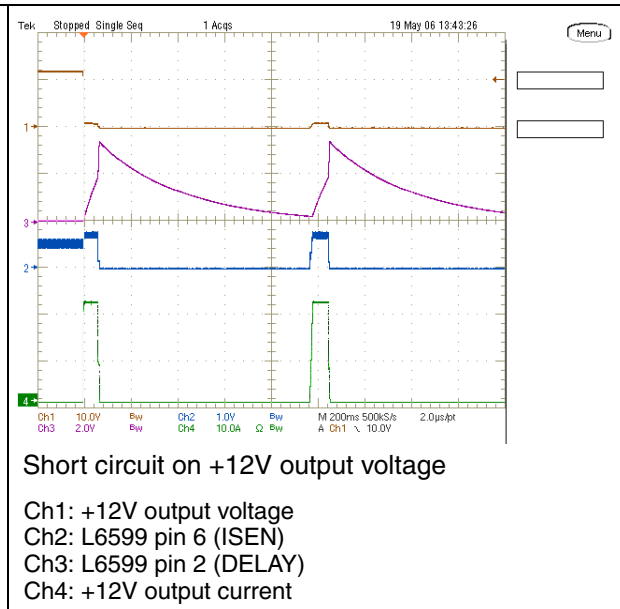

Figure 14. +12V output short-circuit waveforms



2.5 Overvoltage protection

Both the PFC pre-regulator and the resonant converter are equipped with their own overvoltage protection circuit. The PFC controller L6563 is internally equipped with a dynamic and a static overvoltage protection circuit sensing the error amplifier via the voltage divider dedicated to the feedback loop to sense the PFC output voltage. If an internal threshold is exceeded, the IC limits the PFC output voltage to a programmable, safe value.

Moreover, in the L6563 there is an additional protection against loop failures using an additional divider (R5, R7, R9, R16 and R25) connected to a dedicated pin (PFC_OK, Pin 7) protecting the circuit in case of loop failures or disconnection or deviation from the nominal value of the feedback loop divider. Hence the PFC output voltage is always under control and in case a fault condition is detected the PFC_OK circuitry will latch the L6563 operations and, by means of the PWM_LATCH pin (Pin 8) it will latch the L6599 as well via the DIS pin (Pin 8).

The OVP circuit (see [Figure 1](#)) for the output voltages of the resonant converter uses two zener diodes (D21 and D23) to sense the +24V and +12V. If one of the output voltages exceeds the threshold imposed by these zener diodes plus the V_{BE} of Q10, the transistor Q9 starts conducting and the optocoupler U8 opens Q7, so that the V_{AUX} supply voltage of the controller ICs L6563 and L6599 is no longer available. This state is latched until a mains voltage recycle occurs.

3 Thermal tests

In order to check the design reliability, a thermal mapping by means of an IR Camera was performed. *Figure 15* and *Figure 16* show the thermal measurements of the board, component side, at nominal input voltage. The correlation between measurement points and components is indicated for both diagrams.

Figure 15. Thermal map @115Vac - full load

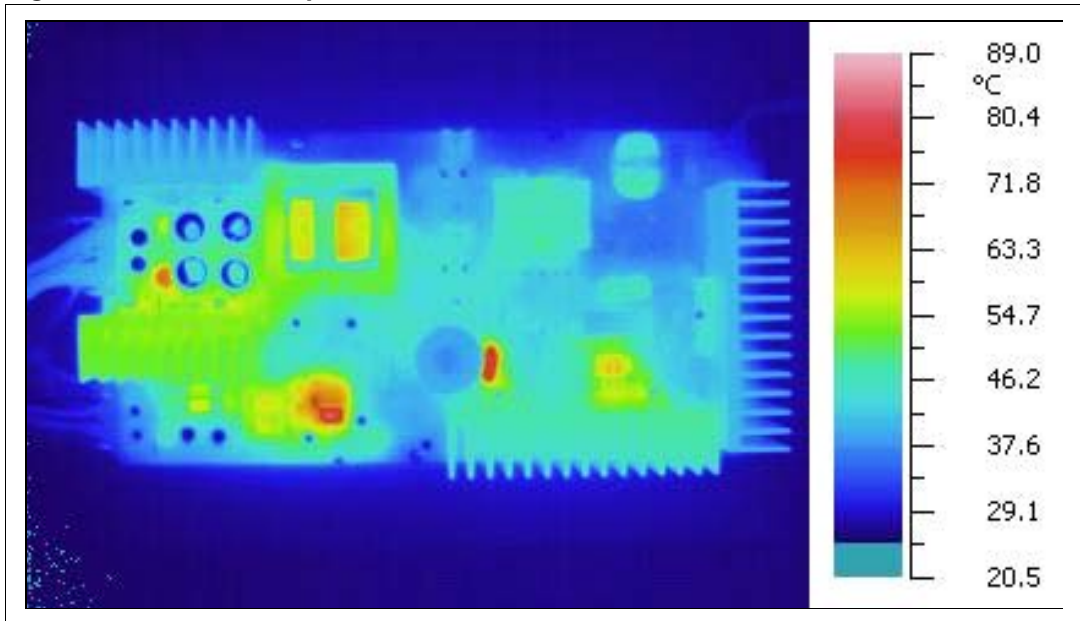

Figure 16. Thermal map at 230 Vac - full load

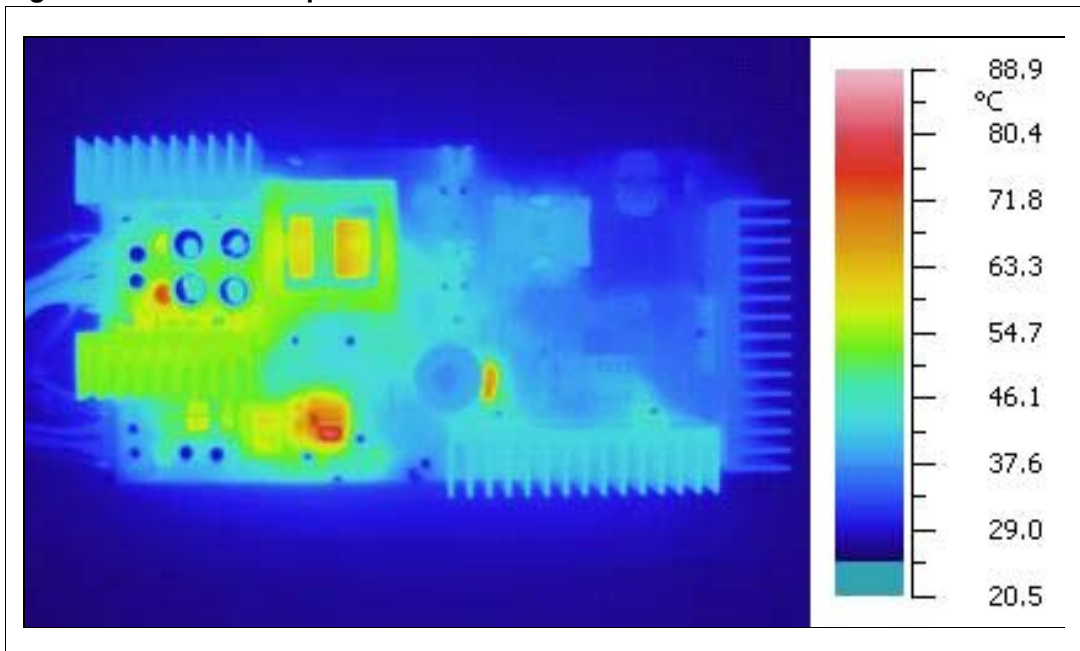

Table 5. Key components temperature at 115 V_{AC} - full load

Ambient temperature: 25° C	
Item	Temp (°C)
D2	44.9
Q2	53.7
D3	50.3
L1	47.0
L3	46.0
L4 (Fe)	45.8
L4 (Cu)	49.2
C8	37.3
R2	78.0
Q5	40.2
Q6	46.7
D8A	56.2
D8B	56.7
D10A	42.1
D10B	42.7
C29	45.1
C30	46.1
C37	42.0
C38	41.6
L5	71.2
L6	56.0
T1	51.7
T1	56.8
U5	81.4
D14	74.2
D15	57.6
D16	55.3
T2	56.4

Table 6. Key components temperature at 230 V_{AC} - full load

Ambient temperature: 25° C	
Item	Temp (°C)
D2	37.1
Q2	46.6
D3	44.0
L1	33.6
L3	34.9
L4 (Fe)	39.1
L4 (Cu)	41.2
C8	37.1
R2	65.8
Q5	38.3
Q6	43.7
D8A	56.4
D8B	55.6
D10A	42.1
D10B	43.8
C29	48.2
C30	47.4
C37	44.3
C38	44.5
L5	73.6
L6	57.3
T1 (Fe)	51.3
T1 (Cu)	58.8
U5	81.8
D14	74.4
D15	59.4
D16	56.3
T2	56.8

All other board components work within the temperature limits, assuring a reliable long term operation of the power supply.

Note that the temperatures of L4 and T1 have been measured both on the ferrite core (Fe) and on the copper (Cu).

4 Conducted emission pre-compliance test

The limits indicated on both diagrams at 115 V_{AC} and 230 V_{AC} comply with EN55022 Class-B specifications. The measurements have been taken in Quasi Peak detection mode.

Figure 17. CE quasi peak measurement at 115 V_{AC} and full load

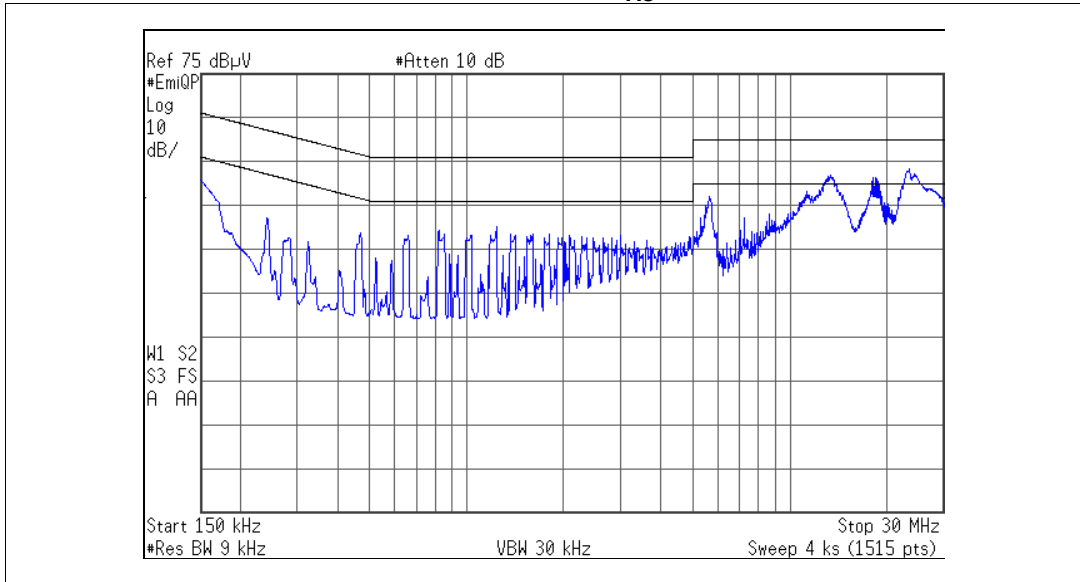
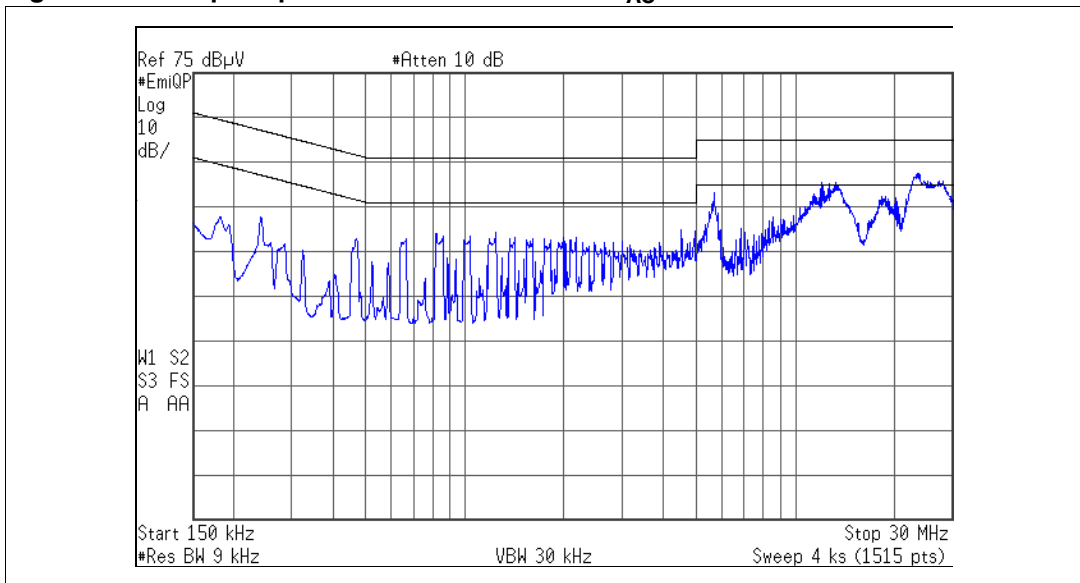

Figure 18. CE quasi peak measurement at 230 V_{AC} and full load



5 Bill of materials

Table 7. Bill of materials

Item	Part type/value	Description	Supplier
C2	100nF-X2	275Vac X2 Safety Capacitor MKP R46	Arcotronics
C3	330nF-X2	275Vac X2 Safety Capacitor MKP R46	Arcotronics
C4	680nF-X2	275Vac X2 Safety Capacitor MKP R46	Arcotronics
C5	330nF/630V	Polypropylene Capacitor High Ripple MKP R71	Arcotronics - Epcos
C6	680nF/630V	Polypropylene Capacitor High Ripple MKP R71	Arcotronics - Epcos
C7	470nF/630V	Polypropylene Capacitor High Ripple MKP R71	Arcotronics - Epcos
C8	220µF/450V	Aluminium ELCAP USC Series 85 DEG SNAP-IN	Rubycon
C9	2nF2-Y1	400Vac Y1 Safety Ceramic Disk Capacitor	Murata
C10	2nF2-Y1	250Vac Y1 Safety Ceramic Disk Capacitor	Murata
C11	2nF2-Y1	250Vac Y1 Safety Ceramic Disk Capacitor	Murata
C12	100nF	50V 1206 SMD Cerecap General Purpose	BC Components
C13	10µF/50V	Aluminium ELCAP General Purpose 85 DEG	Rubycon
C14	100nF	50V 1206 SMD Cerecap General Purpose	BC Components
C15	100pF	100V 0805 SMD Cerecap General Purpose	BC Components
C16	1µF	25V 1206 SMD Cerecap General Purpose	BC Components
C17	220pF	100V 0805 SMD Cerecap General Purpose	BC Components
C18	330pF	100V 0805 SMD Cerecap General Purpose	BC Components
C19	10nF	100V 0805 SMD Cerecap General Purpose	BC Components
C20	470nF	50V 1206 SMD Cerecap General Purpose	BC Components
C21	2nF2	100V 1206 SMD Cerecap General Purpose	BC Components
C22	10nF	100V 0805 SMD Cerecap General Purpose	BC Components
C23	2µF2	25V 1206 SMD Cerecap General Purpose	BC Components
C24	470nF	25V 1206 SMD Cerecap General Purpose	BC Components
C25	470µF/35V	Aluminium ELCAP YXF Series 105 DEG	Rubycon
C26	270pF	100V 0805 SMD Cerecap General Purpose	BC Components
C27	100nF	50V 1206 SMD Cerecap General Purpose	BC Components
C28	22nF/630V/400Vac	Polypropylene Capacitor High Ripple PHE450	RIFA-EVOX
C29	2200µF/35V	Aluminium ELCAP YXF Series 105 DEG	Rubycon
C30	2200µF/35V	Aluminium ELCAP YXF Series 105 DEG	Rubycon
C31	10µF/50V	Aluminium ELCAP General Purpose 85 DEG	Rubycon
C32	100nF	50V 1206 SMD Cerecap General Purpose	BC Components
C33	4nF7	100V 1206 SMD Cerecap General Purpose	BC Components

Table 7. Bill of materials (continued)

Item	Part type/value	Description	Supplier
C34	220pF/630V	Polypropylene Capacitor High Ripple PFR	RIFA-EVOX
C35	470µF/25V	Aluminium ELCAP YXF Series 105 DEG	Rubycon
C37	2200µF/25V	Aluminium ELCAP YXF Series 105 DEG	Rubycon
C38	2200µF/25V	Aluminium ELCAP YXF Series 105 DEG	Rubycon
C39	220nF	50V 1206 SMD Cericap General Purpose	BC Components
C40	10nF	100V 1206 SMD Cericap General Purpose	BC Components
C41	10µF/50V	Aluminium ELCAP General Purpose 85 DEG	Rubycon
C44	47nF	100V 1206 SMD Cericap General Purpose	BC Components
C45	1000µF/10V	Aluminium ELCAP YXF Series 105 DEG	Rubycon
C46	100µF/10V	Aluminium ELCAP YXF Series 105 DEG	Rubycon
C47	1000µF/10V	Aluminium ELCAP YXF Series 105 DEG	Rubycon
C48	10µF/50V	Aluminium ELCAP General Purpose 85 DEG	Rubycon
C49	100µF/10V	Aluminium ELCAP YXF Series 105 DEG	Rubycon
C50	10µF/50V	Aluminium ELCAP General Purpose 85 DEG	Rubycon
C51	100nF	100V 0805 SMD Cericap General Purpose	BC Components
C52	47nF	100V 0805 SMD Cericap General Purpose	BC Components
C53	2nF2	100V 0805 SMD Cericap General Purpose	BC Components
C54	100nF	50V 1206 SMD Cericap General Purpose	BC Components
C55	10µF/50V	Aluminium ELCAP General Purpose 85 DEG	Rubycon
C56	100nF	50V 1206 SMD Cericap General Purpose	BC Components
C57	1nF0	100V 0805 SMD Cericap General Purpose	BC Components
C58	10nF	50V X7R Standard Ceramic Capacitor	BC Components
D1	1N5406	General Purpose Rectifier	Vishay
D2	D15XB60	Single Phase Bridge Rectifier	Shindengen
D3	STTH8R06	TO220FP Ultrafast High Voltage Rectifier	STMicroelectronics
D5	LL4148	MINIMELF Fast Switching Diode	Vishay
D6	LL4148	MINIMELF Fast Switching Diode	Vishay
D7	LL4148	MINIMELF Fast Switching Diode	Vishay
D8A-B	STPS20H100CF	TO220FP Power Schottky Rectifier	STMicroelectronics
D9	LL4148	MINIMELF Fast Switching Diode	Vishay
D10A-B	STPS20L40CF	TO220FP Power Schottky Rectifier	STMicroelectronics
D11	LL4148	MINIMELF Fast Switching Diode	Vishay
D12	LL4148	MINIMELF Fast Switching Diode	Vishay
D13	C-12V	BZV55-C Series Zener Diode	Vishay
D14	PKC-136	Peak Clamp Transil	STMicroelectronics

Table 7. Bill of materials (continued)

Item	Part type/value	Description	Supplier
D15	1N5822	Power Schottky Rectifier	STMicroelectronics
D16	1N5821	Power Schottky Rectifier	STMicroelectronics
D17	LL4148	MINIMELF Fast Switching Diode	Vishay
D18	B-10V	BZV55-B Series Zener Diode	Vishay
D19	C-30V	BZV55-C Series Zener Diode	Vishay
D20	BAV103	General Purpose Diode	Vishay
D21	B-27V	BZV55-B Series Zener Diode	Vishay
D22	C-15V	BZV55-C Series Zener Diode	Vishay
D23	B-15V	BZV55-B Series ZENER DIODE	Vishay
F1	6.3A/250V	T Type Fuse 5 X 20 High Capability & Fuseholder	Wickmann
J1	CON2-IN	3-Pin Connector (Central Removed) P 3.96 KK Series	Molex
J2	CON8	8-Pin Connector P 3.96 KK Series	Molex
J3	CON10	10-Pin Connector P 2.54 MTA Series	AMP
L1	CM-TF2628V-5mH-3A	TF2628 Series Common Mode Toroidal Inductor	TDK
L3	DM-LSR-72 μ H-3A	LSR1803-2 Differential Mode Toroidal Inductor	Delta
L4	PQ35-900 μ H	86H-5409 Boost Inductor	Delta
L5	2 μ H2	RFB0807 Drum Core Inductor	Coilcraft
L6	2 μ H2	RFB0807 Drum Core Inductor	Coilcraft
L7	33 μ H	RFB0807 Drum Core Inductor	Coilcraft
L8	33 μ H	RFB0807 Drum Core Inductor	Coilcraft
Q2	STP12NM50FP	TO220FP N-Channel Power MOSFET	STMicroelectronics
Q3	BC857C	SOT23 Small Signal PNP Transistor	STMicroelectronics
Q5	STP14NK50Z	TO220FP N-Channel Power MOSFET	STMicroelectronics
Q6	STP14NK50Z	TO220FP N-Channel Power MOSFET	STMicroelectronics
Q7	BC547C	TO92 Small Signal PNP Transistor	STMicroelectronics
Q8	BC847C	SOT23 Small Signal PNP Transistor	STMicroelectronics
Q9	BC857C	SOT23 Small Signal PNP Transistor	STMicroelectronics
Q10	BC847C	SOT23 Small Signal NPN Transistor	STMicroelectronics
Q11	BC547C	TO92 Small Signal PNP Transistor	STMicroelectronics
R1	1M5	VR25 Type High Voltage Resistor	BC Components
R2	NTC 2R5-S237	NTC RESISTOR 2R5 S237 Series	Epcos
R3	680k	1206 SMD Standard Film RES 1/4W 5% 200ppm/ $^{\circ}$ C	BC Components
R4	47	0805 SMD Standard Film RES 1/8W 5% 200ppm/ $^{\circ}$ C	BC Components
R5	2M2	1206 SMD Standard Film RES 1/4W 1% 100ppm/ $^{\circ}$ C	BC Components

Table 7. Bill of materials (continued)

Item	Part type/value	Description	Supplier
R6	680k	1206 SMD Standard Film RES 1/4W 5% 200ppm/°C	BC Components
R7	2M2	1206 SMD Standard Film RES 1/4W 1% 100ppm/°C	BC Components
R8	680k	1206 SMD Standard Film RES 1/4W 5% 200ppm/°C	BC Components
R9	2M2	1206 SMD Standard Film RES 1/4W 1% 100ppm/°C	BC Components
R10	100k	0805 SMD Standard Film RES 1/8W 5% 200ppm/°C	BC Components
R11	15k	0805 SMD Standard Film RES 1/8W 5% 200ppm/°C	BC Components
R13	56k	1206 SMD Standard Film RES 1/8W 5% 200ppm/°C	BC Components
R14	1k5	0805 SMD Standard Film RES 1/8W 1% 100ppm/°C	BC Components
R16	5k1	1206 SMD Standard Film RES 1/4W 1% 100ppm/°C	BC Components
R17	15k	0805 SMD Standard Film RES 1/8W 1% 100ppm/°C	BC Components
R18	6R8	0805 SMD Standard Film RES 1/8W 5% 200ppm/°C	BC Components
R19	1K0	0805 SMD Standard Film RES 1/8W 5% 200ppm/°C	BC Components
R20	1k0	Standard Metal Film RES 1/4W 5% 200ppm/°C	BC Components
R21	2R2	Standard Metal Film RES 1/4W 5% 200ppm/°C	BC Components
R22	0R68	PR01 Power Resistor	BC Components
R23	0R68	PR01 Power Resistor	BC Components
R24	0R68	PR01 Power Resistor	BC Components
R25	30k	0805 SMD Standard Film RES 1/8W 1% 100ppm/°C	BC Components
R26	150k	1206 SMD Standard Film RES 1/8W 5% 200ppm/°C	BC Components
R28	240k	0805 SMD Standard Film RES 1/8W 5% 200ppm/°C	BC Components
R29	1k5	0805 SMD Standard Film RES 1/8W 5% 200ppm/°C	BC Components
R30	620k	1206 SMD Standard Film RES 1/4W 5% 200ppm/°C	BC Components
R31	620k	1206 SMD Standard Film RES 1/4W 5% 200ppm/°C	BC Components
R32	10k	0805 SMD Standard Film RES 1/8W 5% 200ppm/°C	BC Components
R33	0R	0805 SMD Standard Film RES 1/8W	BC Components
R34	2k7	0805 SMD Standard Film RES 1/8W 5% 200ppm/°C	BC Components
R35	47	0805 SMD Standard Film RES 1/8W 5% 200ppm/°C	BC Components
R36	0R	0805 SMD Standard Film RES 1/8W	BC Components
R37	1M0	0805 SMD Standard Film RES 1/8W 5% 200ppm/°C	BC Components
R38	47	Standard Metal Film RES 1/4W 5% 200ppm/°C	BC Components
R39	0R	0805 SMD Standard Film RES 1/8W	BC Components
R40	47	0805 SMD Standard Film RES 1/8W 5% 200ppm/°C	BC Components
R41	16k	0805 SMD Standard Film RES 1/8W 1% 100ppm/°C	BC Components
R42	10	1206 SMD Standard Film RES 1/8W 5% 200ppm/°C	BC Components
R43	150	1206 SMD Standard Film RES 1/4W 5% 200ppm/°C	BC Components

Table 7. Bill of materials (continued)

Item	Part type/value	Description	Supplier
R45	75R	1206 SMD Standard Film RES 1/4W 1% 100ppm/°C	BC Components
R46	5k6	0805 SMD Standard Film RES 1/8W 5% 200ppm/°C	BC Components
R47	10k	1206 SMD Standard Film RES 1/8W 5% 200ppm/°C	BC Components
R51	2k2	0805 SMD Standard Film RES 1/8W 5% 200ppm/°C	BC Components
R52	5k6	0805 SMD Standard Film RES 1/8W 5% 200ppm/°C	BC Components
R53	33k	1206 SMD Standard Film RES 1/4W 1% 100ppm/°C	BC Components
R54	5k6	1206 SMD Standard Film RES 1/8W 5% 200ppm/°C	BC Components
R56	1k0	0805 SMD Standard Film RES 1/8W 5% 200ppm/°C	BC Components
R57	15k	1206 SMD Standard Film RES 1/4W 1% 100ppm/°C	BC Components
R58	0R	1206 SMD Standard Film RES 1/4W	BC Components
R59	27k	0805 SMD Standard Film RES 1/8W 5% 200ppm/°C	BC Components
R60	3k9	0805 SMD Standard Film RES 1/8W 1% 100ppm/°C	BC Components
R61	3k9	0805 SMD Standard Film RES 1/8W 1% 100ppm/°C	BC Components
R62	47	0805 SMD Standard Film RES 1/8W 5% 200ppm/°C	BC Components
R64	1k6	0805 SMD Standard Film RES 1/8W 1% 100ppm/°C	BC Components
R66	1k0	0805 SMD Standard Film RES 1/8W 5% 200ppm/°C	BC Components
R67	1k0	0805 SMD Standard Film RES 1/8W 5% 200ppm/°C	BC Components
R68	22k	0805 SMD Standard Film RES 1/8W 5% 200ppm/°C	BC Components
R69	0R	0805 SMD Standard Film RES 1/8W 5% 200ppm/°C	BC Components
R70	22R	0805 SMD Standard Film RES 1/8W 5% 200ppm/°C	BC Components
R71	10k	0805 SMD Standard Film RES 1/8W 5% 200ppm/°C	BC Components
R72	10k	0805 SMD Standard Film RES 1/8W 5% 200ppm/°C	BC Components
R73	8k2	0805 SMD Standard Film RES 1/8W 5% 200ppm/°C	BC Components
R74	10k	0805 SMD Standard Film RES 1/8W 5% 200ppm/°C	BC Components
R75	0R	1206 SMD Standard Film RES 1/4W	BC Components
R76	1k5	1206 SMD Standard Film RES 1/4W 1% 100ppm/°C	BC Components
R77	4k7	0805 SMD Standard Film RES 1/8W 1% 100ppm/°C	BC Components
R79	1k0	0805 SMD Standard Film RES 1/8W 5% 200ppm/°C	BC Components
R82	1k5	1206 SMD Standard Film RES 1/4W 1% 100ppm/°C	BC Components
R83	1M0	VR25 Type High Voltage Resistor	BC Components
R84	150k	Standard Metal Film RES 1/4W 5% 200ppm/°C	BC Components
T1	T-RES-ER49	86H-5411 Type Resonant Transformer ER49-27-17	Delta
T2	T-FLY-AUX-E20	86A-6079-R Type Flyback Transformer E20 Core	Delta
U1	L6563	Advanced Transition Mode PFC Controller	STMicroelectronics
U2	L6599	High Voltage Resonant Controller	STMicroelectronics

Table 7. Bill of materials (continued)

Item	Part type/value	Description	Supplier
U3	SFH617A-2	63-125% CTR Selection Optocoupler	Infineon
U4	TL431	TO92 Programmable Shunt Voltage Regulator	STMicroelectronics
U5	VIPER12A	Low Power Off Line SMPS Primary Switcher	STMicroelectronics
U6	SFH617A-2	63-125% CTR Selection Optocoupler	Infineon
U7	TL431	TO92 Programmable Shunt Voltage Regulator	STMicroelectronics
U8	SFH617A-2	63-125% CTR Selection Optocoupler	Infineon

*Note: Q9 and R72: Mounted by reworking on PCB
Q11, R83, R84 and C58: Added by reworking on PCB*

6 PFC coil specification

- Application type: Consumer, home appliance
- Transformer type: Open
- Coil former: vertical type, 6+6 pins
- Maximum temperature rise: 45° C
- Maximum operating ambient temperature: 60° C

6.1 Electrical characteristics

- Converter topology: FOT-PFC Pre-regulator
- Core type: PQ35-35 material grade PC44 or equivalent
- Maximum operating frequency: 100 kHz
- Primary inductance: 900 μH ±10% @1kHz - 0.25V (see [Note 1](#))
- Primary RMS current: 2.65 A

Note: 1 Measured between Pins 2 and 3 and Pins 10 and 11

Figure 19. PFC coil electrical diagram

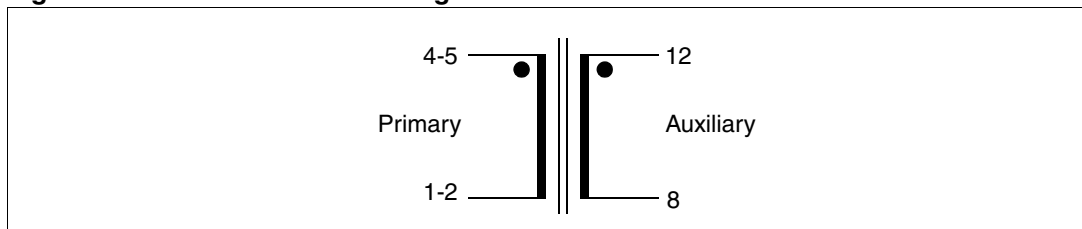

Note: The auxiliary winding is not used in this design, but is foreseen for another application

Table 8. PFC coil winding characteristics

Start pins	End pins	Turn number	Wire type	Wire diameter (mm)	Notes
12	8	5 (spaced)	Single	0.28Ø	Bottom
4 and 5	1 and 2	70	Multistrand - G2	Litz 0.2Ø x 20	Top

6.2 Mechanical aspect and pin numbering

- Maximum height from PCB: 38 mm
- Cut pins: 7, 10 and 11
- Pin distance: 5.08 mm
- Row distance: 35.5 mm

Figure 20. PFC coil pin side view

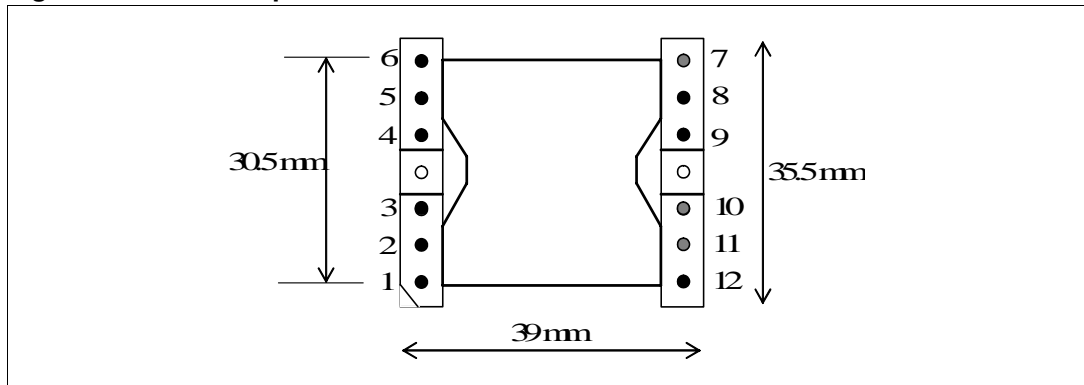

Note: External copper shield 15 x 0.05 (mm) connected to pin 12 by tinned wire
Manufacturer: DELTA ELECTRONICS - Part number: 86H-5409

7 Resonant power transformer specification

- Application type: Consumer, home appliance
- Transformer type: Open
- Coil former: Horizontal type, 7+7 pins, 2 Slots
- Maximum temperature rise: 45° C
- Maximum operating ambient temperature: 60° C
- Mains insulation: Compliance with EN60065 specifications

7.1 Electrical characteristics and mechanical aspect

- Converter topology: half-bridge, resonant
- Core type: ER49 - PC44 or equivalent
- Typical operating frequency: 100 kHz
- Primary inductance: 585 $\mu\text{H} \pm 10\%$ @ 1 kHz - 0.25V (see [Note 1](#))
- Leakage inductance: 110 $\mu\text{H} \pm 10\%$ @ 1 kHz - 0.25V (see [Note 1](#) and [Note 2](#))

Note: 1 Measured between Pins 1 and 3
 2 Measured between Pins 1 and 3 with ONLY a secondary winding shorted

Figure 21. Mechanical aspect and pin numbering of resonant transformer

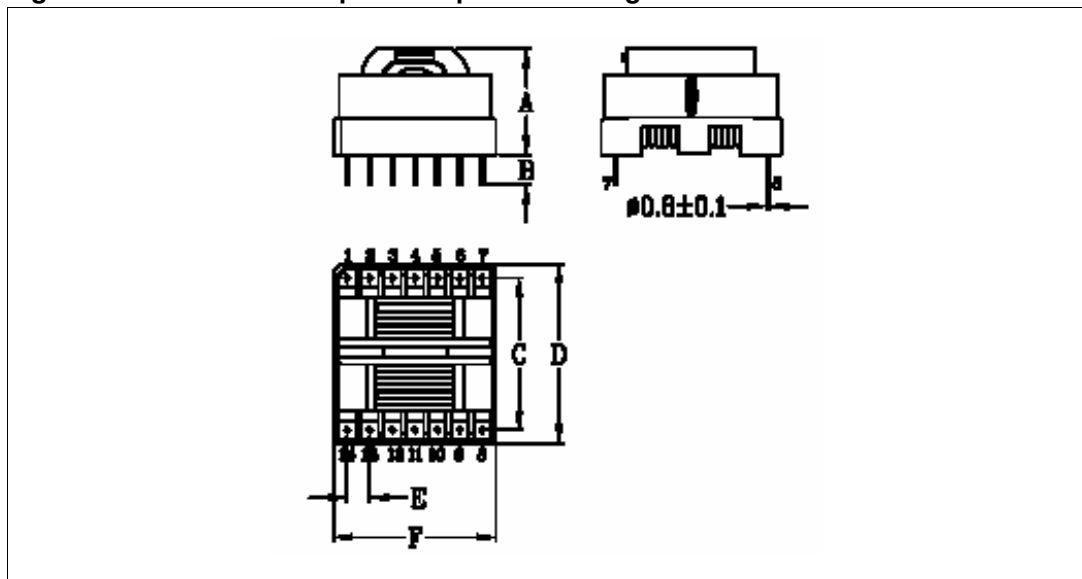

Table 9. Resonant transformer dimensions

	A	B	C	D	E	F
Dimensions (mm)	39.0 MAX	3.5±0.5	41.6±0.4	51 MAX	7.0±0.2	51.5 MAX

Figure 22. Resonant transformer electrical diagram

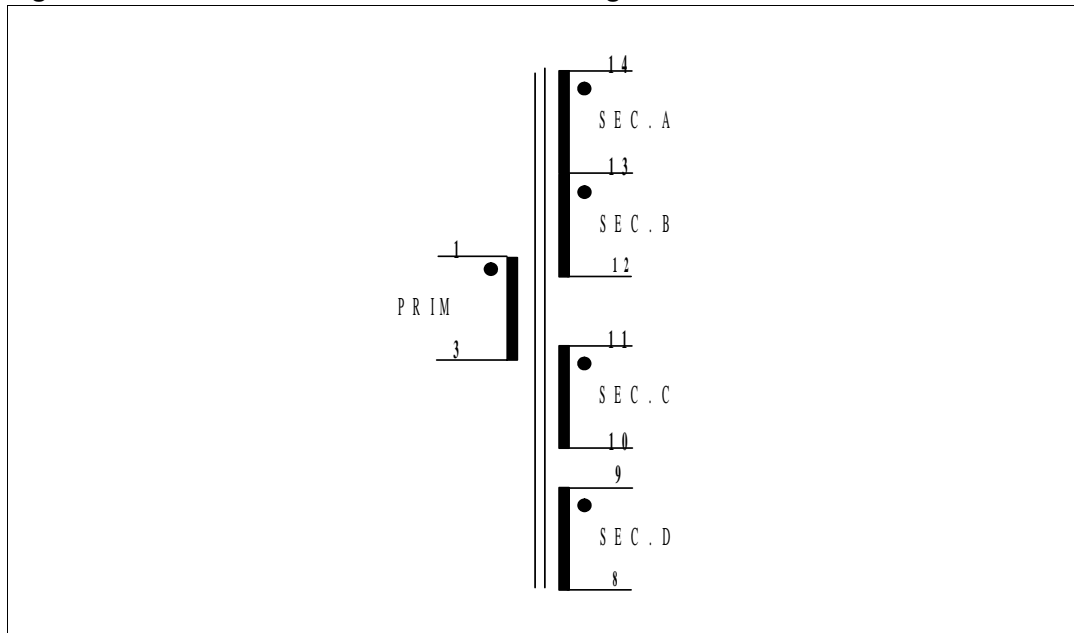
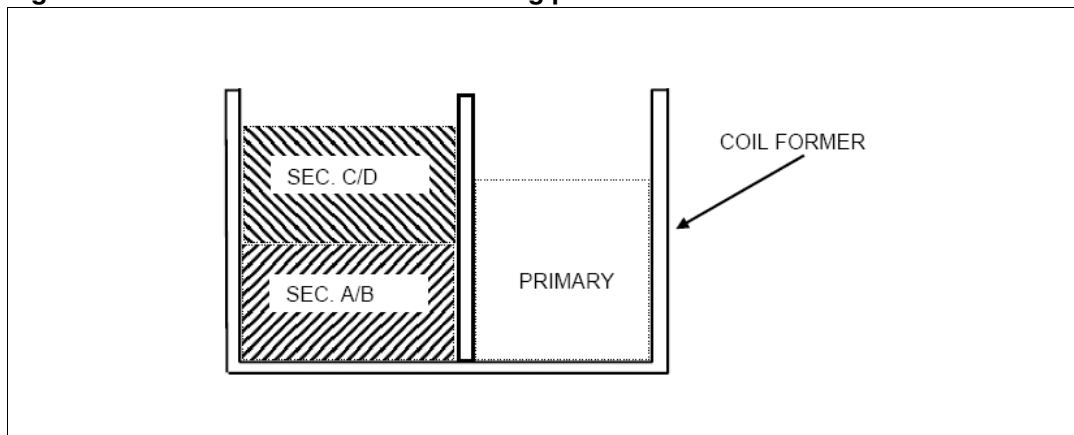

Table 10. Resonant transformer winding characteristics

Pins	Winding	RMS current	Turn number	Wire type [mm]
1 - 3	Primary	1.5 A _{RMS}	36	LITZ - dia. 0.15x20
14 - 13	Sec. A ⁽¹⁾	6.7 A _{RMS}	4	LITZ - dia. 0.20x30
13 - 12	Sec. B ⁽¹⁾	6.7 A _{RMS}	4	LITZ - dia. 0.20x30
11 - 10	Sec. C ⁽²⁾	5.6 A _{RMS}	2	LITZ - dia. 0.20x30
9 - 8	Sec. D ⁽²⁾	5.6 A _{RMS}	2	LITZ - dia. 0.20x30

- 1. Secondary windings A and B must be wound in parallel
- 2. Aux winding is wound on top of primary winding

Figure 23. Resonant transformer winding position on coil former



Note: Manufacturer: DELTA ELECTRONICS - Part number: 86H-5411

8 Auxiliary flyback power transformer

- Application type: Consumer, home appliance
- Transformer type: Open
- Winding type: Layer
- Coil former: Horizontal type, 4+5 pins
- Maximum temperature rise: 45° C
- Maximum operating ambient temperature: 60° C
- Mains insulation: Complies with EN60065 specifications

8.1 Electrical characteristics

- Converter topology: Flyback, DCM/CCM mode
- Core type: E20-N67 or equivalent
- Operating frequency: 60 kHz
- Primary inductance: 4.20 $\mu\text{H} \pm 10\%$ @ 1 kHz - 0.25V (see [Note 1](#))
- Leakage inductance: 50 μH MAX @ 100 kHz - 0.25V (see [Note 2](#))
- Maximum peak primary current: 0.38 Apk
- RMS primary current: 0.2 A_{RMS}

Note: 1 Measured between Pins 4 and 5

2 Measured between Pins 4 and 5 with all secondary windings shorted

Figure 24. Auxiliary transformer electrical diagram

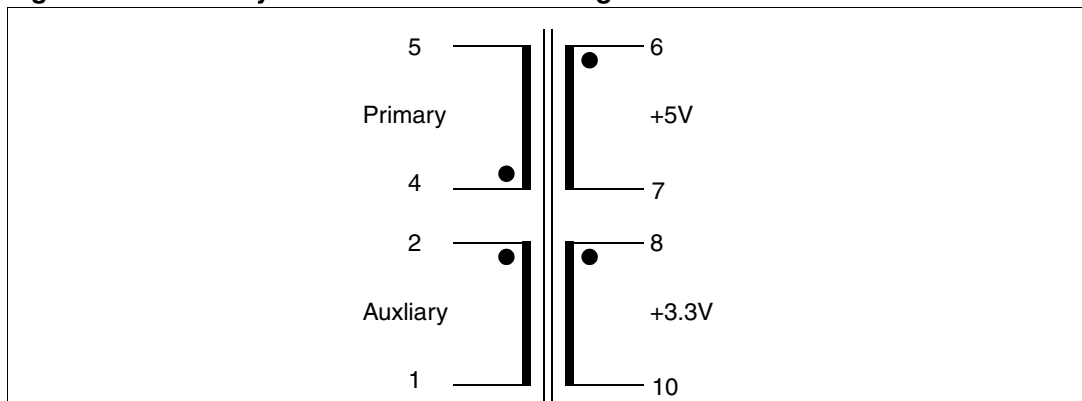

Figure 25. Auxiliary transformer winding position on coil former

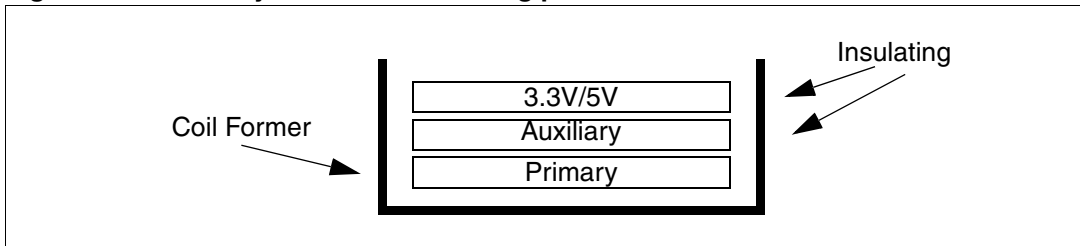

Table 11. Auxiliary transformer winding characteristics

Pins Start - End	Winding	RMS current	Number of turns	Wire type
4-5	PRIMARY	0.2 A _{RMS}	140	G2 - φ0.25 mm
2-1	AUX	0.05 A _{RMS}	29	G2 - φ0.25 mm
8-10	3.3V	1.2 A _{RMS}	7	TIW - φ0.75 mm
6-7	5V	1 A _{RMS}	3	TIW - φ0.75 mm

Note: Manufacturer: DELTA ELECTRONICS - Part number: 86A-6079-R

9 Reference design board layout

Figure 26. Copper tracks

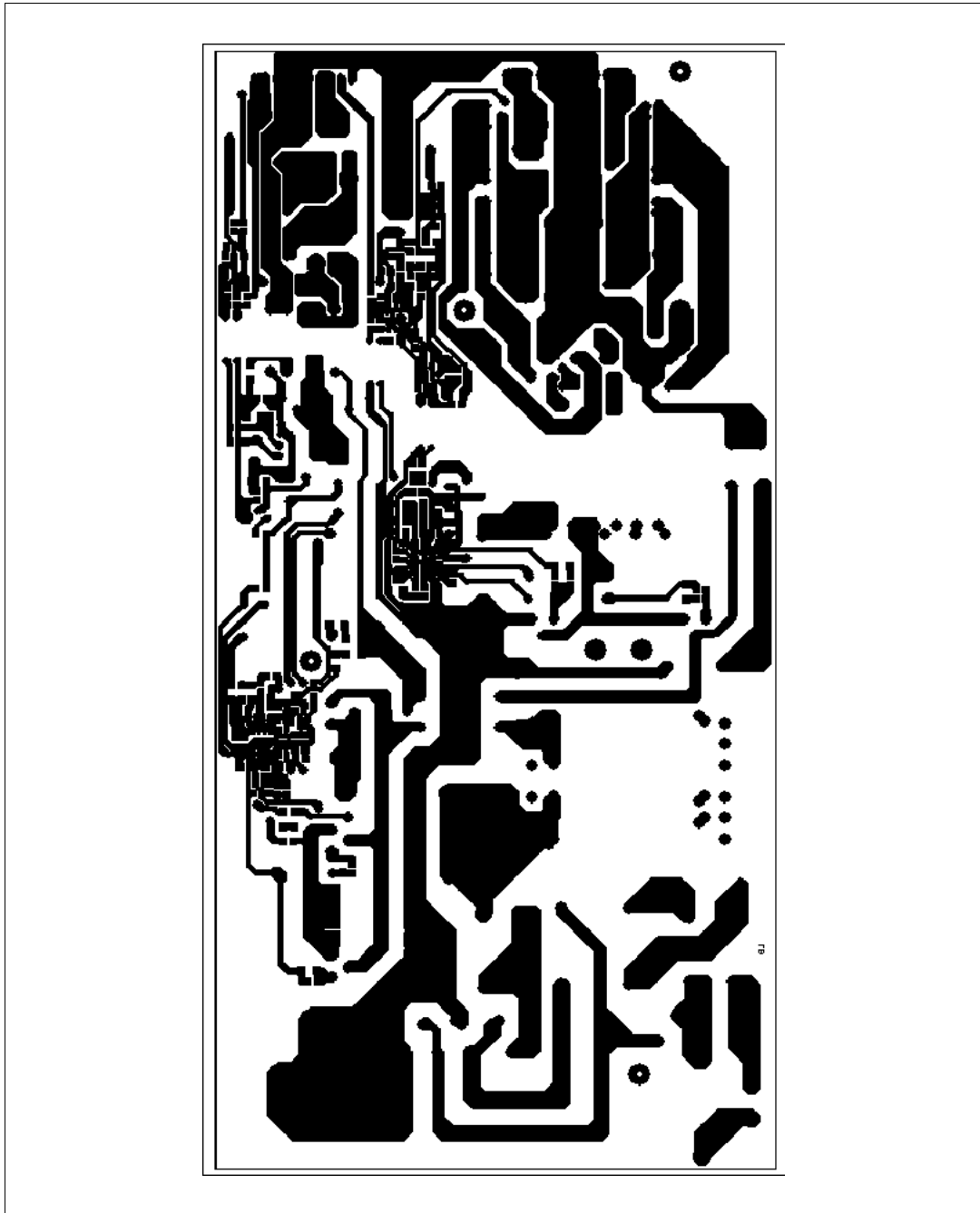

Figure 27. Thru-hole component placing and top silk screen

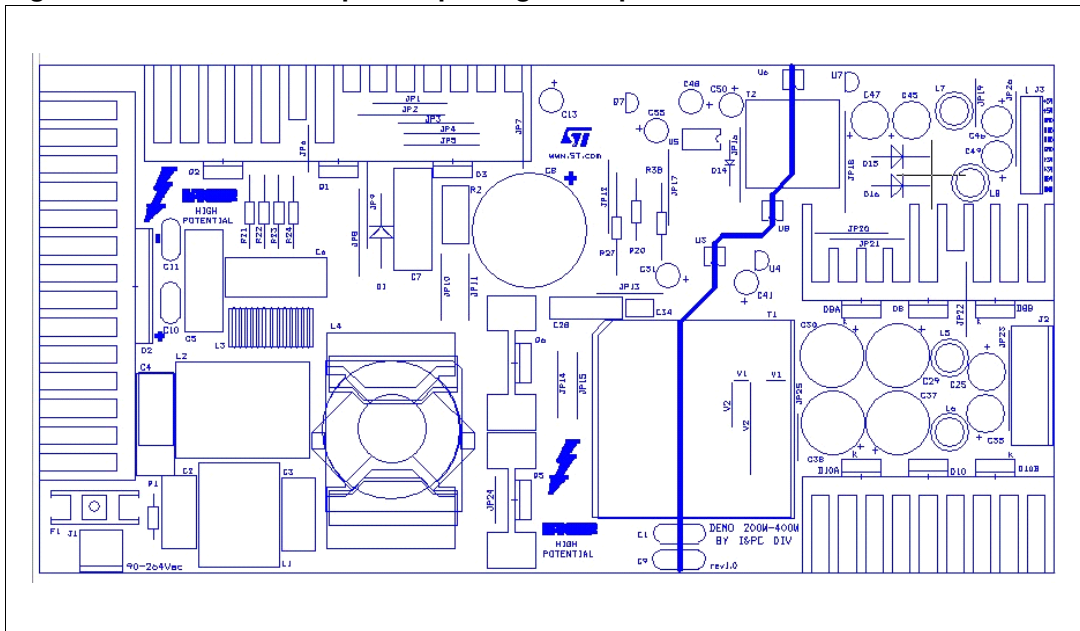
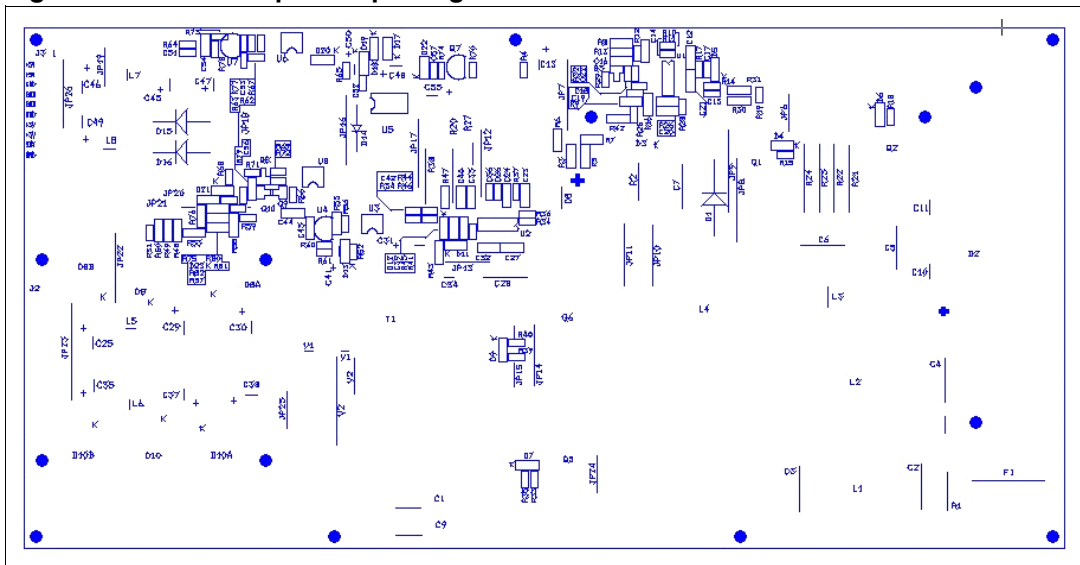

Figure 28. SMT component placing and bottom silk screen



10 Revision history

Table 12. Revision history

Date	Revision	Changes
02-Aug-2006	1	Initial release
08-Sep-2006	2	<i>Figure 2.</i> modified

Please Read Carefully:

Information in this document is provided solely in connection with ST products. STMicroelectronics NV and its subsidiaries ("ST") reserve the right to make changes, corrections, modifications or improvements, to this document, and the products and services described herein at any time, without notice.

All ST products are sold pursuant to ST's terms and conditions of sale.

Purchasers are solely responsible for the choice, selection and use of the ST products and services described herein, and ST assumes no liability whatsoever relating to the choice, selection or use of the ST products and services described herein.

No license, express or implied, by estoppel or otherwise, to any intellectual property rights is granted under this document. If any part of this document refers to any third party products or services it shall not be deemed a license grant by ST for the use of such third party products or services, or any intellectual property contained therein or considered as a warranty covering the use in any manner whatsoever of such third party products or services or any intellectual property contained therein.

UNLESS OTHERWISE SET FORTH IN ST'S TERMS AND CONDITIONS OF SALE ST DISCLAIMS ANY EXPRESS OR IMPLIED WARRANTY WITH RESPECT TO THE USE AND/OR SALE OF ST PRODUCTS INCLUDING WITHOUT LIMITATION IMPLIED WARRANTIES OF MERCHANTABILITY, FITNESS FOR A PARTICULAR PURPOSE (AND THEIR EQUIVALENTS UNDER THE LAWS OF ANY JURISDICTION), OR INFRINGEMENT OF ANY PATENT, COPYRIGHT OR OTHER INTELLECTUAL PROPERTY RIGHT.

UNLESS EXPRESSLY APPROVED IN WRITING BY AN AUTHORIZED ST REPRESENTATIVE, ST PRODUCTS ARE NOT RECOMMENDED, AUTHORIZED OR WARRANTED FOR USE IN MILITARY, AIR CRAFT, SPACE, LIFE SAVING, OR LIFE SUSTAINING APPLICATIONS, NOR IN PRODUCTS OR SYSTEMS WHERE FAILURE OR MALFUNCTION MAY RESULT IN PERSONAL INJURY, DEATH, OR SEVERE PROPERTY OR ENVIRONMENTAL DAMAGE. ST PRODUCTS WHICH ARE NOT SPECIFIED AS "AUTOMOTIVE GRADE" MAY ONLY BE USED IN AUTOMOTIVE APPLICATIONS AT USER'S OWN RISK.

Resale of ST products with provisions different from the statements and/or technical features set forth in this document shall immediately void any warranty granted by ST for the ST product or service described herein and shall not create or extend in any manner whatsoever, any liability of ST.

ST and the ST logo are trademarks or registered trademarks of ST in various countries.

Information in this document supersedes and replaces all information previously supplied.

The ST logo is a registered trademark of STMicroelectronics. All other names are the property of their respective owners.

© 2006 STMicroelectronics - All rights reserved

STMicroelectronics group of companies

Australia - Belgium - Brazil - Canada - China - Czech Republic - Finland - France - Germany - Hong Kong - India - Israel - Italy - Japan - Malaysia - Malta - Morocco - Singapore - Spain - Sweden - Switzerland - United Kingdom - United States of America

www.st.com

