

## 1.6MHz, 600mA Synchronous Step Down Converter in SOT23-5

### FEATURES

- High Efficiency - Up to 95%
- Very Low 24 $\mu$ A Quiescent Current
- Guaranteed 600mA Output Current
- 1.6MHz Constant Frequency Operation
- Internal Synchronous Rectifier Eliminates Schottky Diode
- Adjustable Output Voltages From 0.6V to  $V_{IN}$
- Fixed Output Voltage Options Available
- 100% Duty Cycle Low-Dropout Operation
- 0.1 $\mu$ A Shutdown Current
- Tiny SOT23-5 Package

### APPLICATIONS

- Blue Tooth Headsets
- Portable Audio Players
- Mobile Phones
- Wireless and DSL Modems
- Digital Still Cameras
- Portable Instruments

### GENERAL DESCRIPTION

The ACT6906 is a fixed-frequency current-mode synchronous PWM step down converter that is capable of delivering 600mA of output current while achieving peak efficiency of 95%. Under light load conditions, the ACT6906 operates in a proprietary pulse skipping mode that consumes just 24 $\mu$ A of supply current, maximizing battery life in portable applications. The ACT6906 operates with a fixed frequency of 1.6MHz, minimizing noise in noise-sensitive applications and allowing the use of small external components. The ACT6906 is an ideal solution for applications powered by Li-Ion batteries or other portable applications that require small board space.

The ACT6906 is available in a variety of fixed output voltage options, 1.5V, 1.8V, and 2.5V, and is also available in an adjustable output voltage version capable of generating output voltages from 0.6V to  $V_{IN}$ . The ACT6906 is available in a tiny 5-pin SOT23-5 package.

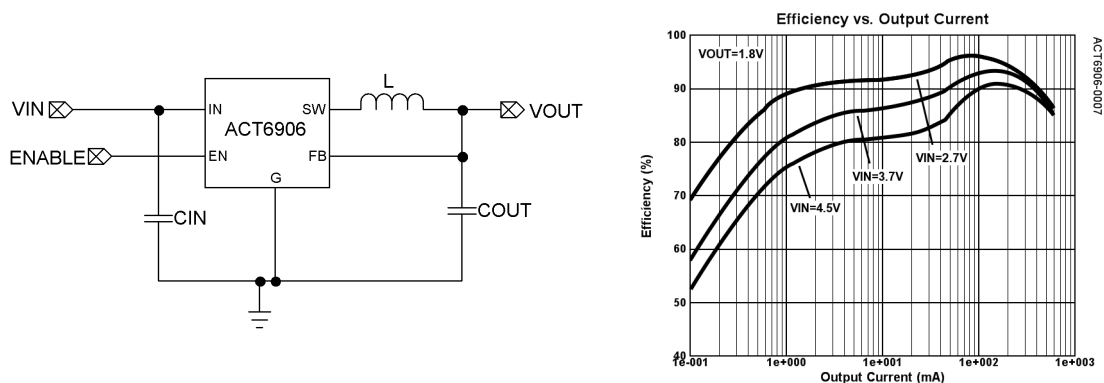

Figure 1. Typical Application Circuit and Efficiency

## ORDERING INFORMATION

PART NUMBER <sup>(1)(2)</sup>	TEMPERATURE RANGE	OUTPUT VOLTAGE (V)	PACKAGE	TOP MARK
ACT6906UC150-T	-40° C to 85° C	1.5	SOT23-5	IAFX
ACT6906UC180-T	-40° C to 85° C	1.8	SOT23-5	IAFA
ACT6906UC250-T	-40° C to 85° C	2.5	SOT23-5	IAFB
ACT6906UCADJ-T	-40° C to 85° C	Adjustable	SOT23-5	IAFM

<sup>(1)</sup> Contact factory for other output voltage options

<sup>(2)</sup> -T denotes Tape & Reel packing

## PIN CONFIGURATION

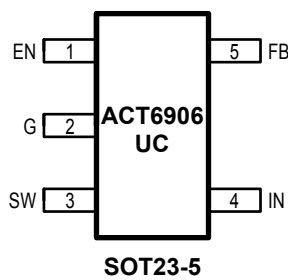

## PIN DESCRIPTION

PIN NUMBER	PIN NAME	PIN DESCRIPTION
1	EN	Enable Control Input. Drive EN to IN or to a logic high for normal operation, drive to G or a logic low to disable the regulator.
2	G	Ground.
3	SW	Switching Node Output. Connect this pin to the switching end of the inductor.
4	IN	Power Input. Bypass to G as close as possible to the IC with a high quality ceramic capacitor.
5	FB	Feedback Node. For fixed output voltage options, connect this pin directly to the output. For the adjustable output version the voltage at this pin is regulated to 0.6V; connect to this pin to the center of the output voltage feedback network.

## ABSOLUTE MAXIMUM RATINGS

(Note: Exceeding these limits may damage the device. Exposure to absolute maximum rating conditions for long periods may affect device reliability.)

PARAMETER	VALUE	UNIT
IN, FB, EN to G	-0.3 to 6	V
SW to G	-0.3 to $V_{IN} + 0.3$	V
Continuous SW Current	Internally limited	A
Junction to Ambient Thermal Resistance ( $\theta_{JA}$ )	190	°C/W
Maximum Power Dissipation (derate 5.3mW/°C above $T_A = 50^\circ\text{C}$ )	0.53	W
Operating Junction Temperature	-40 to 150	°C
Storage Temperature	-55 to 150	°C
Lead Temperature (Soldering, 10 sec)	300	°C

## ELECTRICAL CHARACTERISTICS

( $V_{IN} = V_{EN} = 3.6\text{V}$ ,  $T_A = 25^\circ\text{C}$  unless otherwise specified.)

PARAMETER	SYMBOL	TEST CONDITIONS	MIN	TYP	MAX	UNIT
Input Voltage Range	$V_{IN}$		2.7		5.5	V
Under Voltage Lockout Threshold	$V_{UVLO}$	$V_{IN}$ rising, hysteresis = 0.1V	2.25	2.4	2.5	V
Operating Supply Current		$V_{FB} = 60\%$ , $I_{OUT} = 0$		586		$\mu\text{A}$
Standby Supply Current		$V_{FB} = 105\%$ , $I_{OUT} = 0$		22	33	$\mu\text{A}$
Shutdown Supply Current		$V_{EN} = 0\text{V}$ , $V_{IN} = 4.2\text{V}$		0.1	5	$\mu\text{A}$
Adjustable Version Regulation Voltage (ACT6906UCADJ)	$V_{FB}$	$T_A = 25^\circ\text{C}$	0.591	0.6	0.609	V
		$0 < T_A < 85^\circ\text{C}$	0.588	0.6	0.612	
		$-40^\circ\text{C} < T_A < 85^\circ\text{C}$	0.582	0.6	0.618	
Fixed Output Regulation Voltage	$V_{OUT}$	ACT6906UC150	1.473	1.5	1.527	V
		ACT6906UC180	1.768	1.8	1.832	
		ACT6906UC250	2.455	2.5	2.545	
Output Voltage Line Regulation		$V_{IN} = 3\text{V to } 5\text{V}$		0.016	0.4	%/V
Output Voltage Load Regulation		$I_{OUT} = 10\text{mA to } 500\text{mA}$		0.5		%
Inductor Current Limit	$I_{LIM}$	$V_{IN} = 3.6\text{V}$ , $V_{FB} = 90\%$ of $V_{OUT(NOM)}$		0.9		A
Oscillator Frequency	$f_{SW}$	$V_{FB}$ or $V_{OUT}$ in regulation	1.3	1.6	1.9	MHz
		$V_{FB}$ or $V_{OUT} = 80\%$ of $V_{OUT(NOM)}$		360		kHz
PMOS On Resistance	$R_{ONP}$	$I_{SW} = -100\text{mA}$		0.37	0.6	$\Omega$
NMOS On Resistance	$R_{ONN}$	$I_{SW} = 100\text{mA}$		0.36	0.6	$\Omega$
SW Leakage Current		EN = G, $V_{IN} = 5.5\text{V}$ , $V_{SW} = 5.5\text{V}$ or 0V			1	$\mu\text{A}$
EN Logic High Threshold	$V_{IH}$	$V_{IN} = 2.7\text{V to } 5.5\text{V}$	1.4			V
EN Logic Low Threshold	$V_{IL}$	$V_{IN} = 2.7\text{V to } 5.5\text{V}$			0.4	V
EN Input Bias Current	$I_{EN}$	$V_{IN} = 5.5\text{V}$ , EN = G or IN		0.01	0.1	$\mu\text{A}$

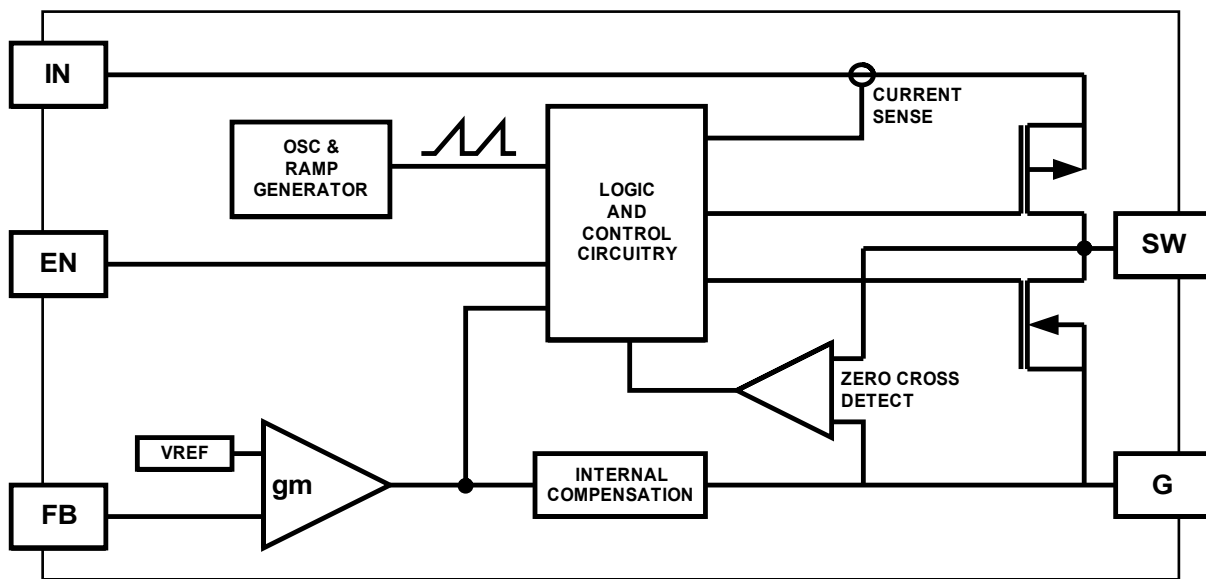

Figure 2. Functional Block Diagram

## FUNCTIONAL DESCRIPTION

### CONTROL SCHEME

The ACT6906 utilizes a fixed-frequency, current-mode PWM control scheme combined with fully-integrated power MOSFETs to produce a compact and efficient step-down DC-DC solution. During normal operation the high-side MOSFET turns on each cycle and remains on until the current comparator turns it off. At this point the low-side MOSFET turns on and remains on until either the end of the switching cycle or until the inductor current approaches zero. The error amplifier adjusts the current comparator's threshold as necessary in order to ensure that the output voltage remains in regulation.

### LIGHT LOAD POWER SAVING OPERATION

When operating under light-load conditions, the ACT6906 uses a proprietary and patent-pending control scheme that reduces quiescent supply current to maximize efficiency while maintaining output voltage regulation. Under light load conditions the ACT6906 reduces its

switching frequency in order to achieve high efficiency. Whenever the feedback voltage falls below the regulation voltage the high-side MOSFET turns on and remains on for a period of time that is controlled by the ACT6906 control circuitry. The duration of the on cycle is dynamically adjusted to maximize efficiency under all load current conditions.

### SOFT START

The ACT6906 integrates a 50 $\mu$ s soft start function that prevents input inrush current and output overshoot during start up.

### OVER-CURRENT PROTECTION

The ACT6906 has an internal current limit of 900mA, which is detected on a cycle by cycle basis. When this maximum inductor current limit is reached the charging cycle is terminated, and the low-side MOSFET is turned on to allow the inductor current to decrease. Under extreme overloads, such as short-circuit conditions, the ACT6906 reduces its oscillator frequency to 360kHz to allow further inductor current reduction and to minimize power dissipation.

## APPLICATION INFORMATION

### INDUCTOR SELECTION

Under normal operation, the inductor maintains continuous current to the output. This inductor current has a ripple that is dependent on the inductance value: higher inductance reduces the peak-to-peak ripple current. In general, select an inductance value L based on ripple current requirement:

$$L = \frac{V_{OUT} \cdot (V_{IN} - V_{OUT})}{V_{IN} f_{SW} I_{OUTMAX} K_{RIPPLE}} \quad (1)$$

where  $V_{IN}$  is the input voltage,  $V_{OUT}$  is the output voltage,  $f_{SW}$  is the switching frequency,  $I_{OUTMAX}$  is the maximum output current, and  $K_{RIPPLE}$  is the ripple factor. Typically, choose  $K_{RIPPLE} = 30\%$  to correspond to the peak-to-peak ripple current being 30% of the maximum output current.

With this inductor value (Table 1), the peak inductor current is  $I_{OUT} \cdot (1 + K_{RIPPLE} / 2)$ . Make sure that this peak inductor current is less than the 0.9A current limit. Finally, select the inductor core size so that it does not saturate at the current limit value.

**Table 1. Typical Inductor Values**

$V_{OUT}$	0.6V to 0.9V	0.9V to 1.8V	>1.8V
L	1.5 $\mu$ H	2.2 $\mu$ H	2.7 $\mu$ H

### INPUT CAPACITOR SELECTION

The input capacitor reduces input voltage ripple to the converter; a 4.7 $\mu$ F ceramic capacitor is recommended for most applications. The input capacitor should be placed as close as possible to IN and G, with short, wide traces.

### OUTPUT CAPACITOR SELECTION

A low ESR output capacitor is required in order to maintain low output voltage ripple. Output ripple voltage is given by:

$$V_{RIPPLE} = I_{OUTMAX} K_{RIPPLE} R_{ESR} + \frac{V_{IN}}{28 \cdot f_{SW}^2 L C_{OUT}} \quad (2)$$

where  $I_{OUTMAX}$  is the maximum output current,  $K_{RIPPLE}$  is the ripple factor,  $R_{ESR}$  is the ESR of the output capacitor,  $f_{SW}$  is the switching frequency, L is the inductor value, and  $C_{OUT}$  is the output capacitance. In the case of ceramic output capacitors,  $R_{ESR}$  is very small and does not contribute to the ripple. Therefore, a lower capacitance value is acceptable when ceramic capacitors are used. A 10 $\mu$ F ceramic output capacitor is suitable for most applications.

### OUTPUT VOLTAGE PROGRAMMING

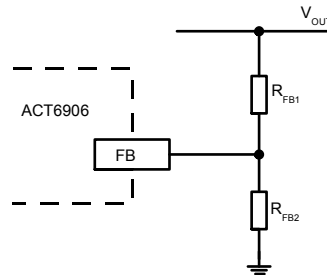

**Figure 3. Output Voltage Programming**

Figure 3 shows the feedback network necessary to set the output voltage when the adjustable version is used. Select the proper ratio of the two feedback resistors  $R_{FB1}$  and  $R_{FB2}$  based on the desired output voltage. Typically choose  $R_{FB2} \approx 100k\Omega$  and determine  $R_{FB1}$  from the output voltage:

$$R_{FB1} = R_{FB2} \left( \frac{V_{OUT}}{0.6V} - 1 \right) \quad (3)$$

Connect a small capacitor across  $R_{FB1}$  for Feed forward capacitance at the FB pin:

$$C_{ff} = 2E - 5/R_{FB1} \quad (4)$$

where  $R_{FB1} = 900k\Omega$ , use 22pF. When using very low ESR output capacitors, such as ceramic, check for stability while examining load-transient response, and increase the compensation capacitor C1 if needed.

## TYPICAL PERFORMANCE CHARACTERISTICS

( $V_{IN} = V_{EN} = 3.6V$ ,  $L = 2.2\mu H$ ,  $C_{IN} = 4.7\mu F$ ,  $C_{OUT} = 10\mu F$ , unless otherwise specified.)

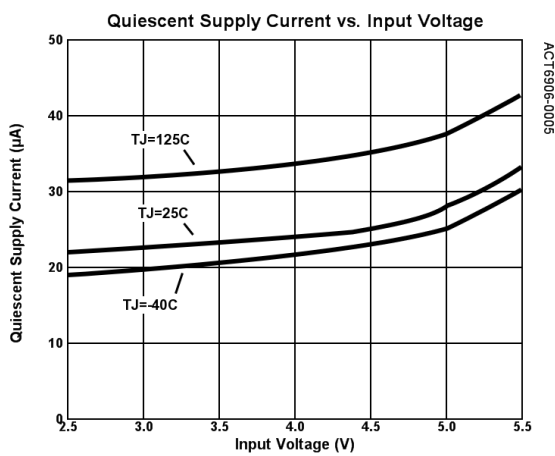
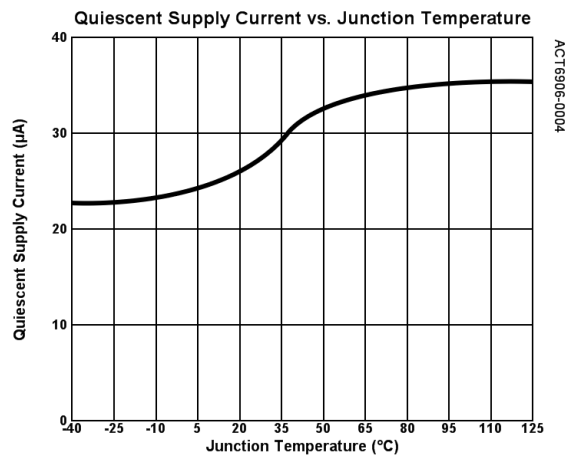
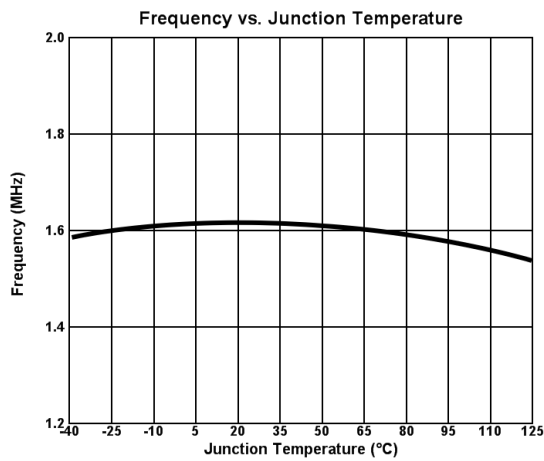
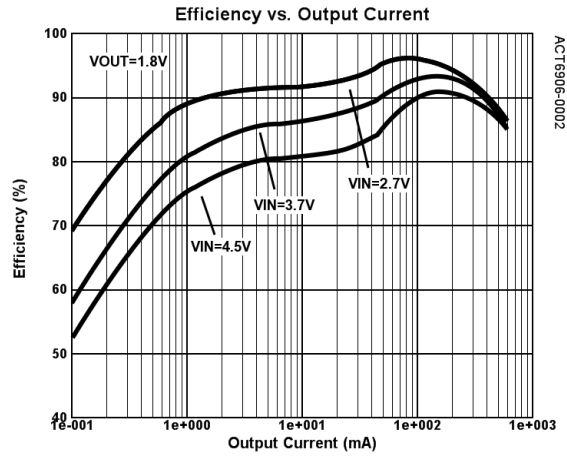
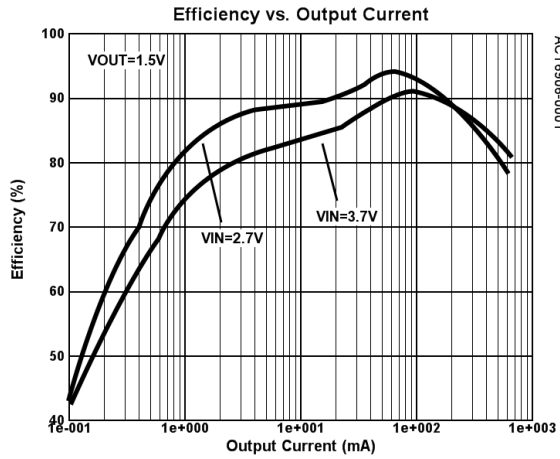

## TYPICAL PERFORMANCE CHARACTERISTICS CONT'D

( $V_{IN} = V_{EN} = 3.6V$ ,  $L = 2.2\mu H$ ,  $C_{IN} = 4.7\mu F$ ,  $C_{OUT} = 10\mu F$ , unless otherwise specified.)

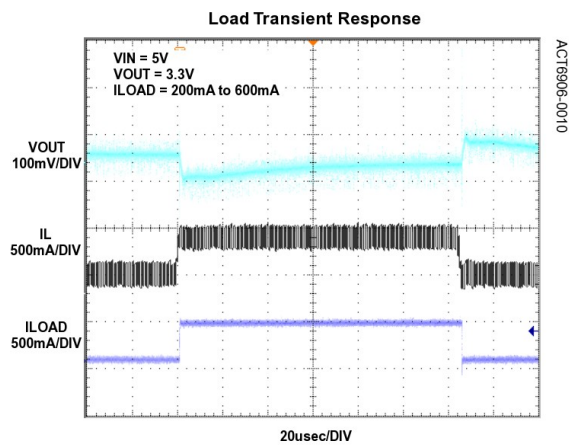
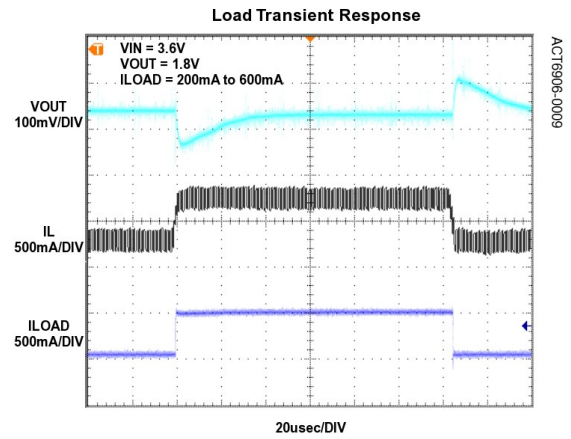
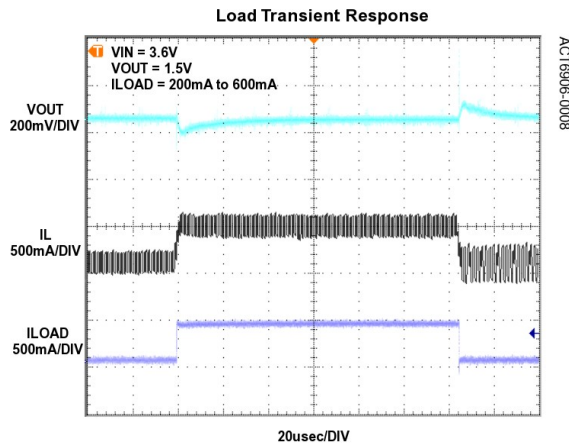

## PACKAGE OUTLINE

### SOT23-5 PACKAGE OUTLINE AND DIMENSIONS

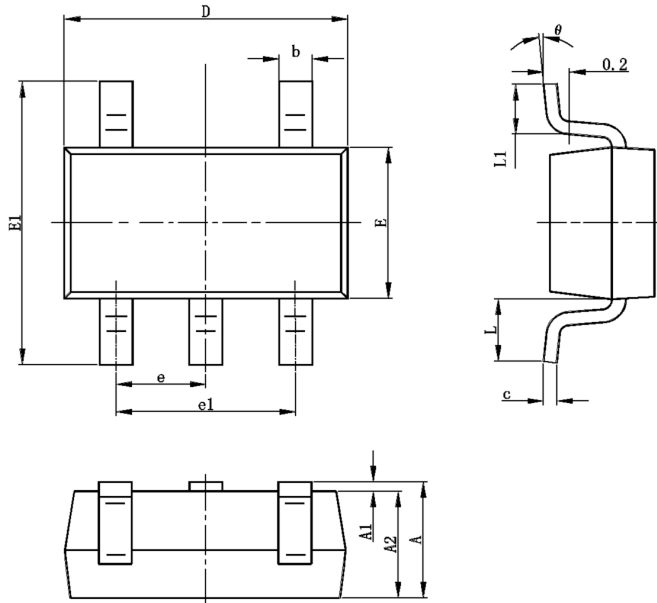

SYMBOL	DIMENSION IN MILLIMETERS		DIMENSION IN INCHES	
	MIN	MAX	MIN	MAX
A	1.050	1.250	0.041	0.049
A1	0.000	0.100	0.000	0.004
A2	1.050	1.150	0.041	0.045
b	0.300	0.400	0.012	0.016
c	0.100	0.200	0.004	0.008
D	2.820	3.020	0.111	0.119
E	1.500	1.700	0.059	0.067
E1	2.650	2.950	0.104	0.116
e	0.950 TYP		0.037 TYP	
e1	1.800	2.000	0.071	0.079
L	0.700 REF		0.028 REF	
L1	0.300	0.600	0.012	0.024
$\theta$	0°	8°	0°	8°

Active-Semi, Inc. reserves the right to modify the circuitry or specifications without notice. Users should evaluate each product to make sure that it is suitable for their applications. Active-Semi products are not intended or authorized for use as critical components in life-support devices or systems. Active-Semi, Inc. does not assume any liability arising out of the use of any product or circuit described in this data sheet, nor does it convey any patent license.

1270 Oakmead Parkway, Suite 310, Sunnyvale, California 94085-4044, USA