



AO3401

P-Channel Enhancement Mode Field Effect Transistor

General Description

The AO3401 uses advanced trench technology to provide excellent $R_{DS(ON)}$, low gate charge and operation with gate voltages as low as 2.5V. This device is suitable for use as a load switch or in PWM applications.

Features

- $V_{DS} (V) = -30V$
- $I_D = -4.2 A$
- $R_{DS(ON)} < 50m\Omega (V_{GS} = -10V)$
- $R_{DS(ON)} < 65m\Omega (V_{GS} = -4.5V)$
- $R_{DS(ON)} < 120m\Omega (V_{GS} = -2.5V)$

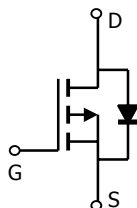
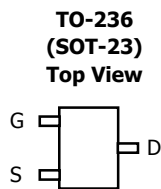

Absolute Maximum Ratings $T_A=25^\circ C$ unless otherwise noted

Parameter	Symbol	Maximum	Units
Drain-Source Voltage	V_{DS}	-30	V
Gate-Source Voltage	V_{GS}	± 12	V
Continuous Drain Current ^A	$T_A=25^\circ C$	-4.2	A
	$T_A=70^\circ C$	-3.5	
Pulsed Drain Current ^B	I_{DM}	-30	
Power Dissipation ^A	$T_A=25^\circ C$	1.4	W
	$T_A=70^\circ C$	1	
Junction and Storage Temperature Range	T_J, T_{STG}	-55 to 150	$^\circ C$

Thermal Characteristics

Parameter	Symbol	Typ	Max	Units
Maximum Junction-to-Ambient ^A	$R_{\theta JA}$	65	90	$^\circ C/W$
Maximum Junction-to-Ambient ^A		Steady-State	85	
Maximum Junction-to-Lead ^C	$R_{\theta JL}$	43	60	$^\circ C/W$

Electrical Characteristics ($T_J=25^\circ\text{C}$ unless otherwise noted)

Symbol	Parameter	Conditions	Min	Typ	Max	Units
STATIC PARAMETERS						
BV_{DSS}	Drain-Source Breakdown Voltage	$I_D=-250\mu\text{A}$, $V_{GS}=0\text{V}$	-30			V
I_{DSS}	Zero Gate Voltage Drain Current	$V_{DS}=-24\text{V}$, $V_{GS}=0\text{V}$ $T_J=55^\circ\text{C}$			-1 -5	μA
I_{GSS}	Gate-Body leakage current	$V_{DS}=0\text{V}$, $V_{GS}=\pm 12\text{V}$			± 100	nA
$V_{GS(th)}$	Gate Threshold Voltage	$V_{DS}=V_{GS}$, $I_D=-250\mu\text{A}$	-0.7	-1	-1.3	V
$I_{D(ON)}$	On state drain current	$V_{GS}=-4.5\text{V}$, $V_{DS}=-5\text{V}$	-25			A
$R_{DS(ON)}$	Static Drain-Source On-Resistance	$V_{GS}=-10\text{V}$, $I_D=-4.2\text{A}$ $T_J=125^\circ\text{C}$		42	50	$\text{m}\Omega$
		$V_{GS}=-4.5\text{V}$, $I_D=-4\text{A}$		53	65	$\text{m}\Omega$
		$V_{GS}=-2.5\text{V}$, $I_D=-1\text{A}$		80	120	$\text{m}\Omega$
g_{FS}	Forward Transconductance	$V_{DS}=-5\text{V}$, $I_D=-5\text{A}$	7	11		S
V_{SD}	Diode Forward Voltage	$I_S=-1\text{A}$, $V_{GS}=0\text{V}$		-0.75	-1	V
I_S	Maximum Body-Diode Continuous Current				-2.2	A
DYNAMIC PARAMETERS						
C_{iss}	Input Capacitance	$V_{GS}=0\text{V}$, $V_{DS}=-15\text{V}$, $f=1\text{MHz}$		954		pF
C_{oss}	Output Capacitance			115		pF
C_{rss}	Reverse Transfer Capacitance			77		pF
R_g	Gate resistance	$V_{GS}=0\text{V}$, $V_{DS}=0\text{V}$, $f=1\text{MHz}$		6		Ω
SWITCHING PARAMETERS						
Q_g	Total Gate Charge	$V_{GS}=-4.5\text{V}$, $V_{DS}=-15\text{V}$, $I_D=-4\text{A}$		9.4		nC
Q_{gs}	Gate Source Charge			2		nC
Q_{gd}	Gate Drain Charge			3		nC
$t_{D(on)}$	Turn-On Delay Time	$V_{GS}=-10\text{V}$, $V_{DS}=-15\text{V}$, $R_L=3.6\Omega$, $R_{GEN}=6\Omega$		6.3		ns
t_r	Turn-On Rise Time			3.2		ns
$t_{D(off)}$	Turn-Off Delay Time			38.2		ns
t_f	Turn-Off Fall Time			12		ns
t_{rr}	Body Diode Reverse Recovery Time	$I_F=-4\text{A}$, $di/dt=100\text{A}/\mu\text{s}$		20.2		ns
Q_{rr}	Body Diode Reverse Recovery Charge	$I_F=-4\text{A}$, $di/dt=100\text{A}/\mu\text{s}$		11.2		nC

A: The value of $R_{\theta JA}$ is measured with the device mounted on 1in² FR-4 board with 2oz. Copper, in a still air environment with $T_A=25^\circ\text{C}$. The value in any a given application depends on the user's specific board design. The current rating is based on the $t \leq 10\text{s}$ thermal resistance rating.

B: Repetitive rating, pulse width limited by junction temperature.

C: The $R_{\theta JA}$ is the sum of the thermal impedance from junction to lead $R_{\theta JL}$ and lead to ambient.

D: The static characteristics in Figures 1 to 6,12,14 are obtained using 80 μs pulses, duty cycle 0.5% max.

E: These tests are performed with the device mounted on 1 in² FR-4 board with 2oz. Copper, in a still air environment with $T_A=25^\circ\text{C}$. The SOA curve provides a single pulse rating.

TYPICAL ELECTRICAL AND THERMAL CHARACTERISTICS

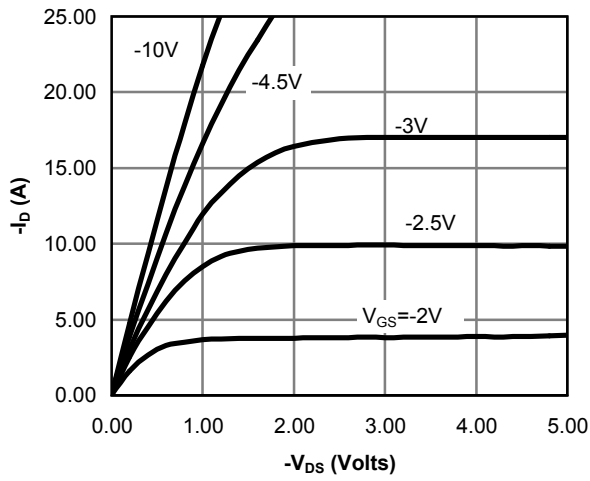

Fig 1: On-Region Characteristics

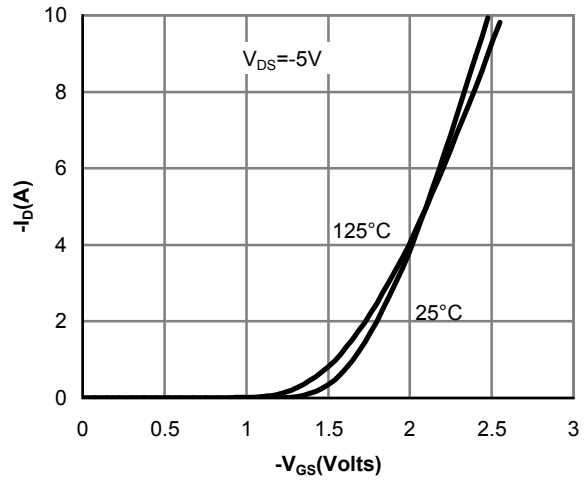

Figure 2: Transfer Characteristics

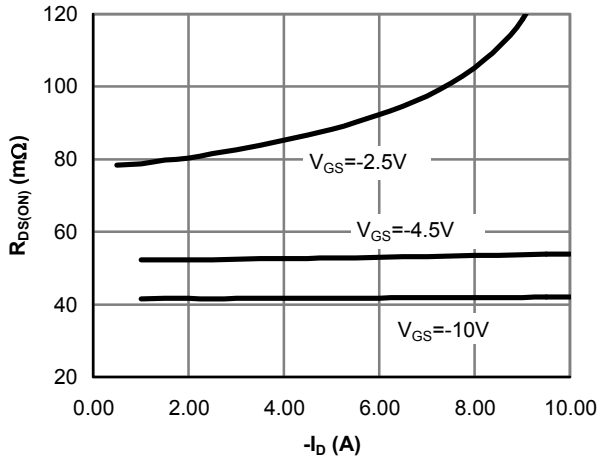

Figure 3: On-Resistance vs. Drain Current and Gate Voltage

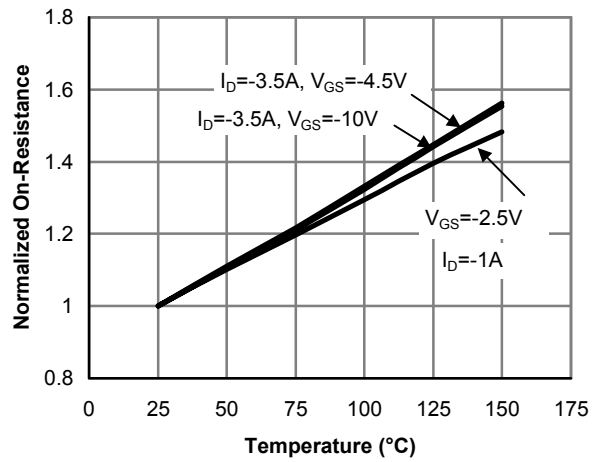

Figure 4: On-Resistance vs. Junction Temperature

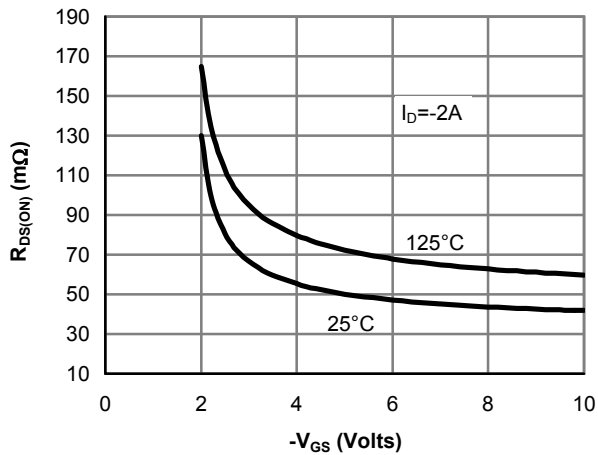

Figure 5: On-Resistance vs. Gate-Source Voltage

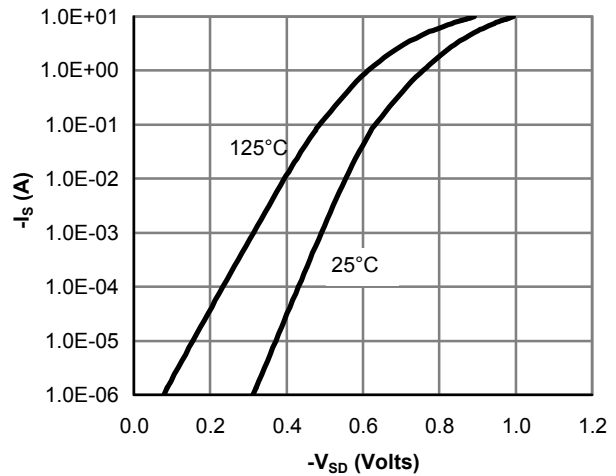

Figure 6: Body-Diode Characteristics

TYPICAL ELECTRICAL AND THERMAL CHARACTERISTICS

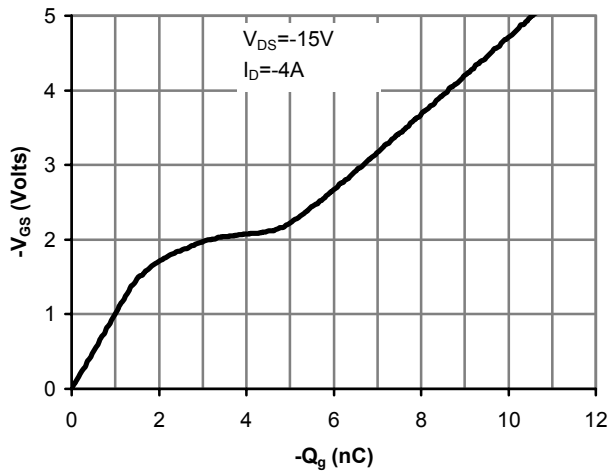

Figure 7: Gate-Charge Characteristics

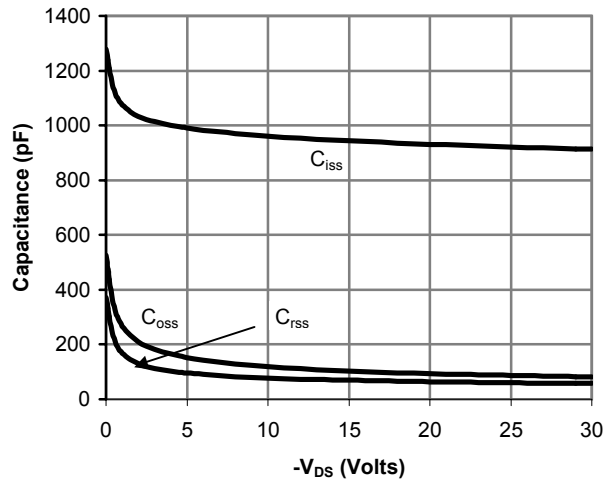

Figure 8: Capacitance Characteristics

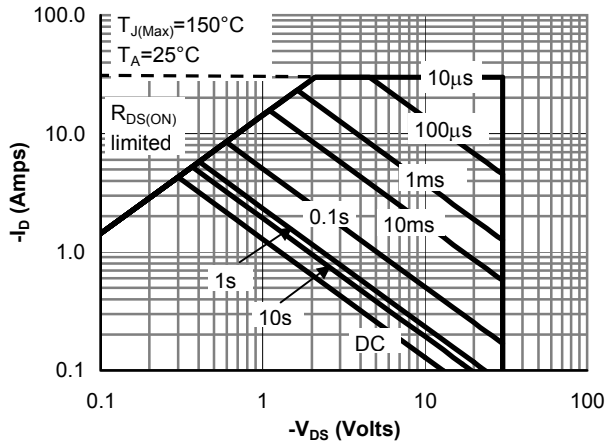

Figure 9: Maximum Forward Biased Safe Operating Area (Note E)

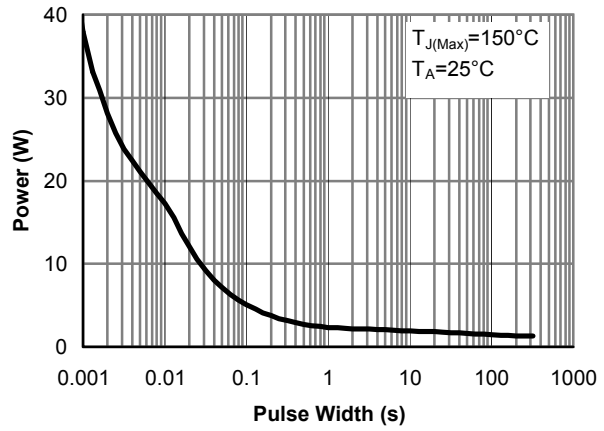

Figure 10: Single Pulse Power Rating Junction-to-Ambient (Note E)

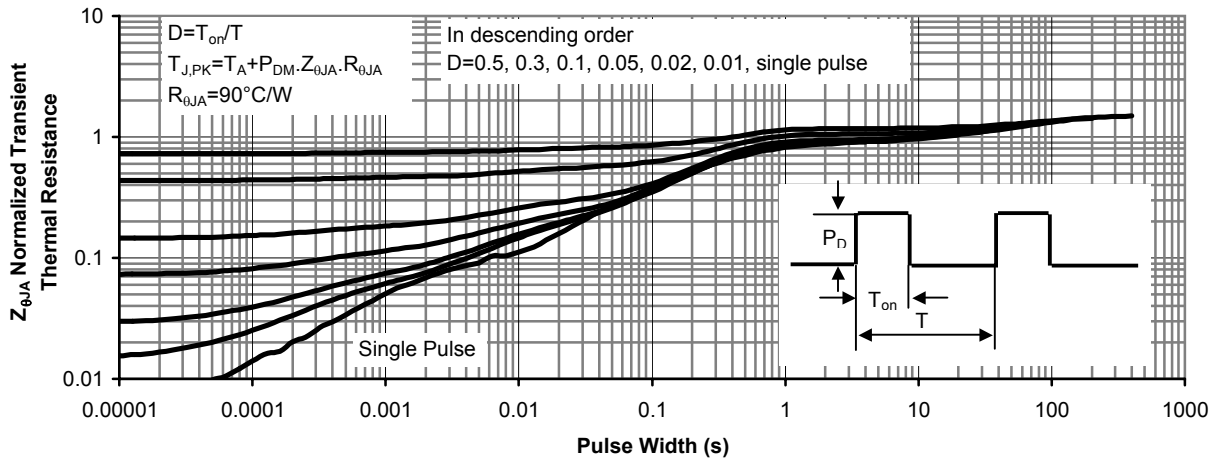
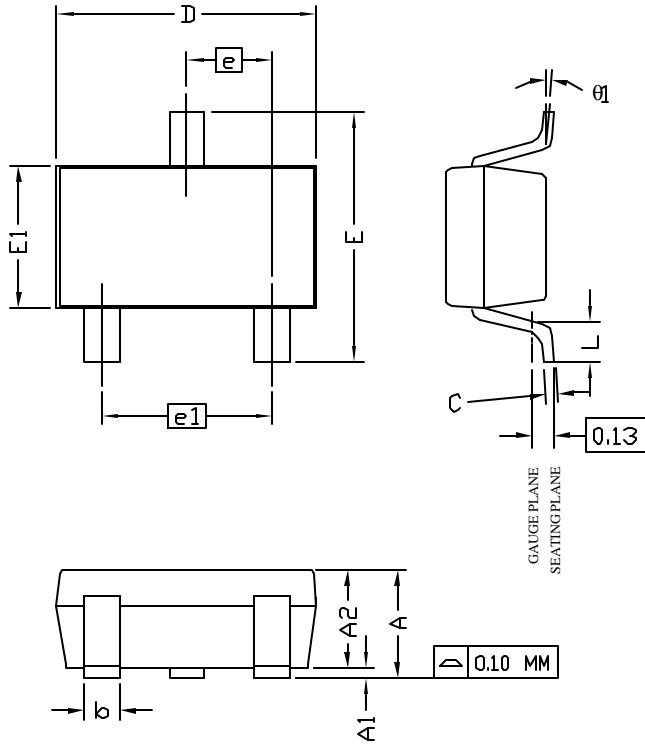

Figure 11: Normalized Maximum Transient Thermal Impedance



ALPHA & OMEGA
SEMICONDUCTOR, INC.

SOT-23 Package Data



SYMBOLS	DIMENSIONS IN MILLIMETERS		
	MIN	NOM	MAX
A	1.00	—	1.25
A1	0.00	—	0.10
A2	1.00	1.10	1.15
b	0.35	0.40	0.50
C	0.10	0.15	0.25
D	2.80	2.90	3.04
E	2.60	2.80	2.95
E1	1.40	1.60	1.80
e	—	0.95 BSC	—
e1	—	1.90 BSC	—
L	0.40	—	0.60
$\theta 1$	1°	5°	8°

- NOTE:
- LEAD FINISH: 150 MICRONS (3.8 um) MIN.
THICKNESS OF Tin/Lead (SOLDER) PLATED ON LEAD
 - TOLERANCE = ±0.100 mm (4 mil) UNLESS OTHERWISE SPECIFIED
 - COPLANARITY : 0.1000 mm
 - DIMENSION L IS MEASURED IN GAGE PLANE

PACKAGE MARKING DESCRIPTION

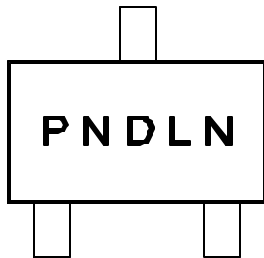

NOTE:
P N - PART NUMBER CODE.
D - YAER AND WEEK CODE.
L N - ASSEMBLY LOT CODE, FAB AND ASSEMBLY LOCATION CODE.

SOT-23 PART NO. CODE

PART NO.	CODE
AO3400	A0
AO3401	A1

RECOMMENDED LAND PATTERN

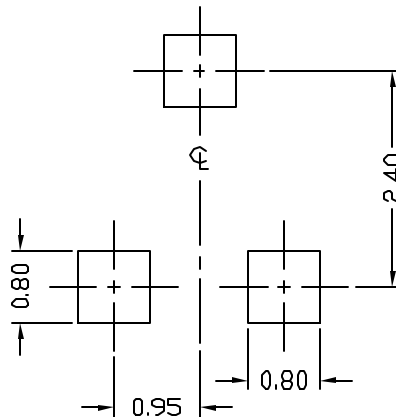



SOT-23 Carrier Tape

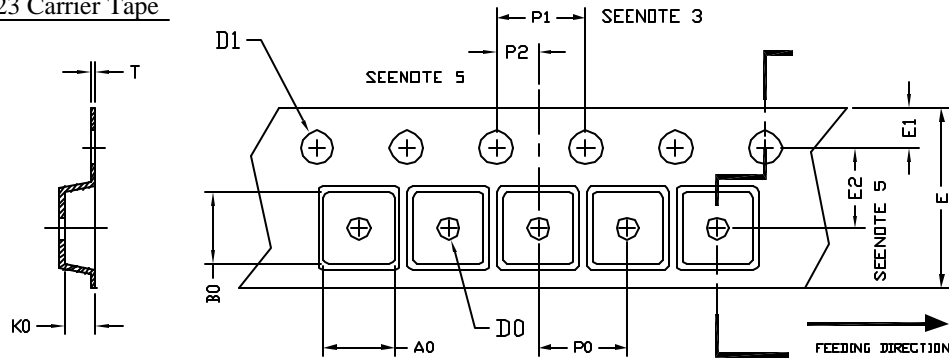

UNIT: MM

PACKAGE	A0	B0	K0	D0	D1	E	E1	E2	P0	P1	P2	T
SOT-23 (8 mm)	3.15 ±0.10	3.20 ±0.10	1.40 ±0.10	1.00 MIN	1.30 +0.10	8.00 ±0.30	1.75 ±0.10	3.50 ±0.05	4.00 ±0.10	4.00 ±0.10	2.00 ±0.05	0.25 ±0.05

SOT-23 Reel

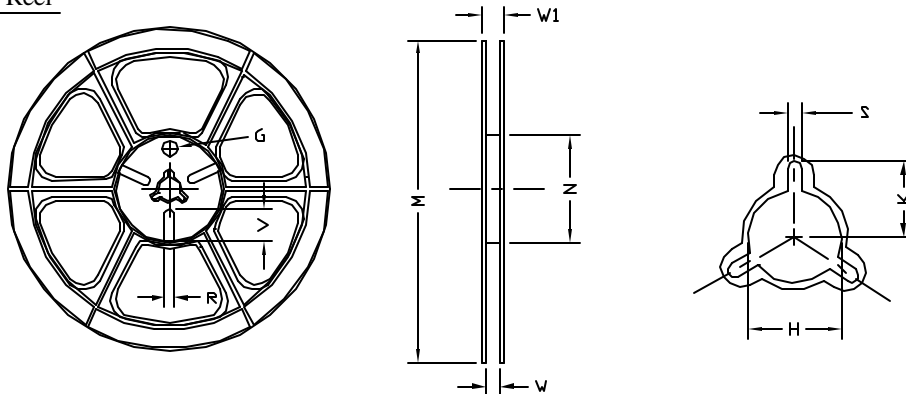

UNIT: MM

TAPE SIZE	REEL SIZE	M	N	W	W1	H	K	S	G	R	V
8 mm	φ180	φ180.00 ±0.50	φ60.50	9.00 ±0.30	11.40 ±1.00	φ13.00 +0.50 -0.20	10.60	2.00 ±0.50	φ9.00	5.00	18.00

SOT-23 Tape

Leader / Trailer
& Orientation

