



# SP6002

## Synchronous Rectifier Driver

### DESCRIPTION

The fundamental of SP6002 synchronous rectifier (SR) driver IC is based on our U.S. patented methods that utilize the principle of “prediction” logic circuit. The IC deliberates previous cycle timing to control the SR in present cycle by “predictive” algorithm that makes adjustments to the turn-off time, in order to achieve maximum efficiency and avoid cross-conduction at the same time. It also maintains the MOSFET’s body diode conduction at minimum level. The SP6002 is capable to adapt in almost all existing forward converters with few adjustments considered necessary.

### FEATURES

- Offers 4 to 8% efficiency improvement over Schottky Diodes (depend on drive configuration of the SR).
- Drives all logic level Power MOSFET.
- Prediction gate timing control.
- Minimum MOSFET body diode conduction.
- Operating frequency up to 650 KHz.
- Synchronize to transformer secondary voltage waveform.

### APPLICATIONS

- Servers & workstations
- Storage area network power supplies
- Telecommunication converters
- Embedded systems
- Industrial & commercial systems using high current processors

### PIN CONFIGURATION (SOP-8)



### PART MARKING

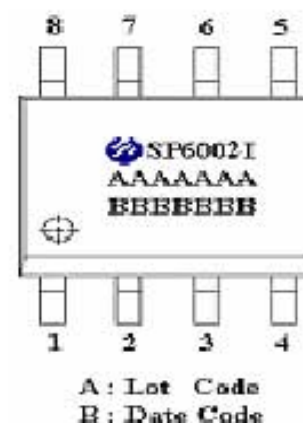



# SP6002 Synchronous Rectifier Driver

## TYPICAL APPLICATION CIRCUIT

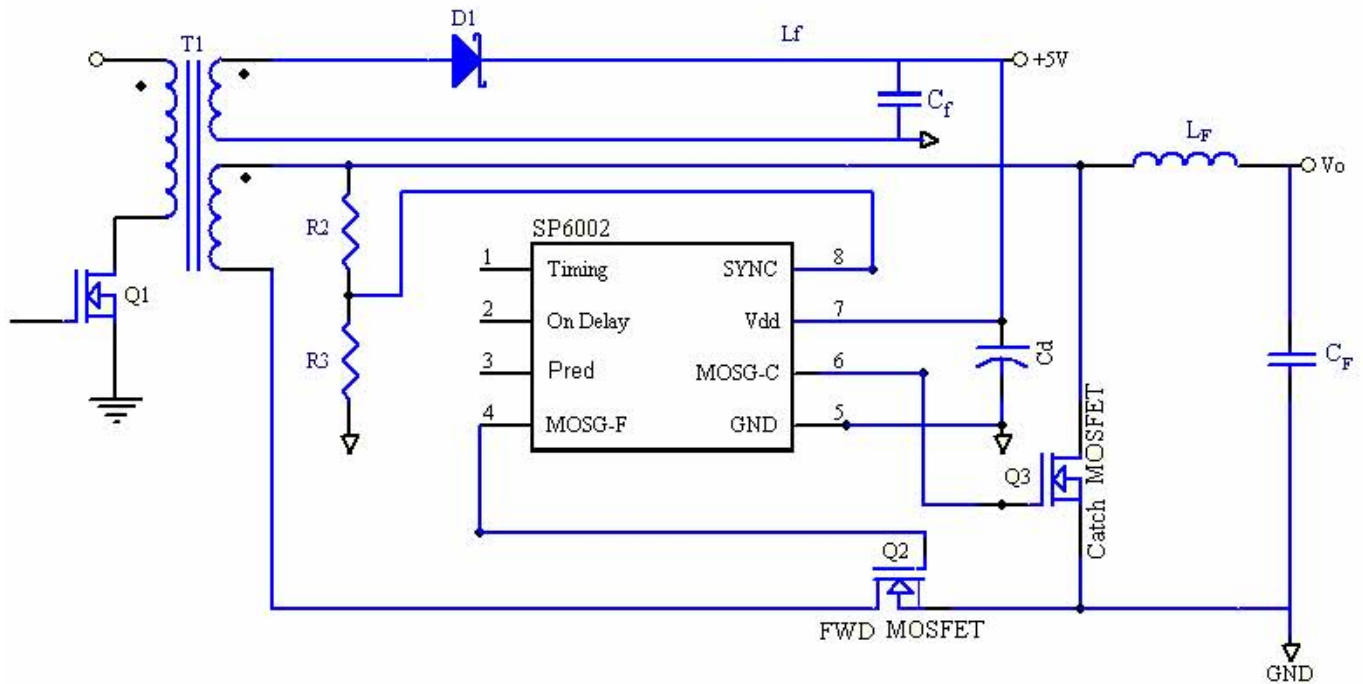

## PIN DESCRIPTION

Pin	Symbol	Description
1	Timing	Discontinuous current filter timing adjustment resistor connection.
2	On Delay	Imposed delay between Catch gate turn OFF and Forward gate turn ON.
3	Pred	Capacitor to store previous cycle timing for Catch MOSFET
4	MOSG-F	Forward MOSFET gate drive.
5	GND	Ground connection.
6	MOSG-C	Catch MOSFET gate drive.
7	Vdd	DC supply voltage.
8	SYNC	Synchronized signal from transformer's output.



# SP6002

## Synchronous Rectifier Driver

### BLOCK DIAGRAM

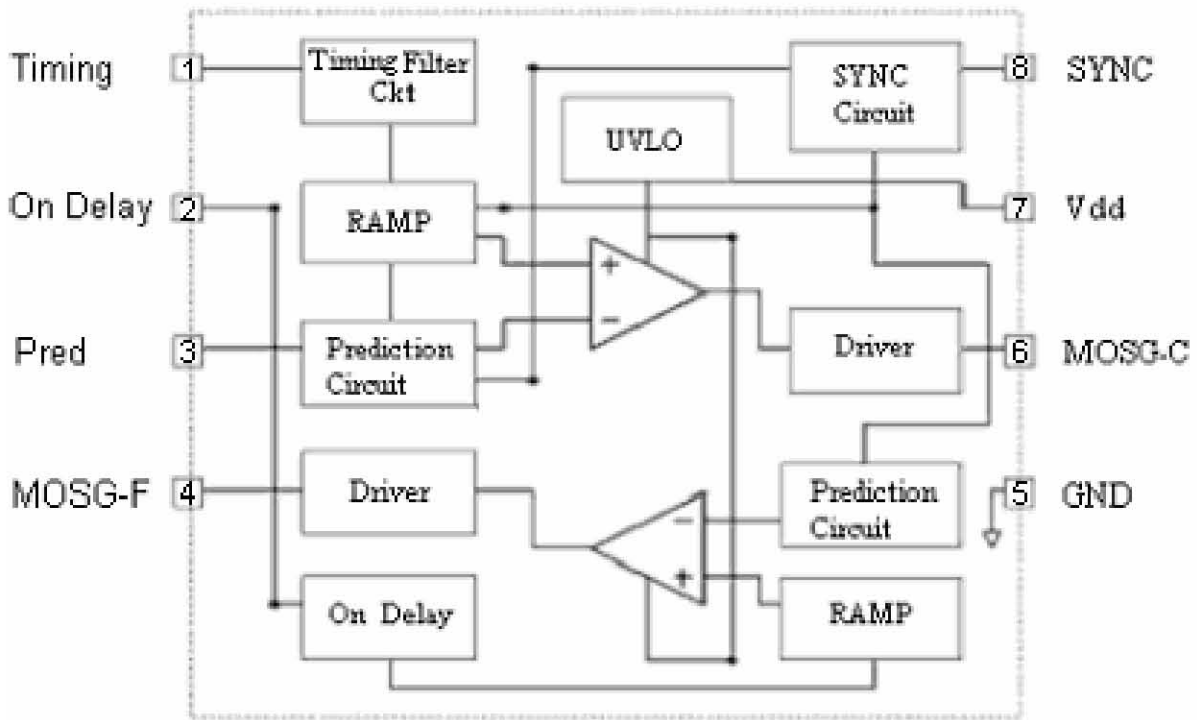

### ORDERING INFORMATION

Part Number	Package	Part Marking
SP6002S8RG	SOP-8	SP6002I
SP6002S8TG	SOP-8	SP6002I

※ SP6002S8RG : 7" Tape Reel ; Pb – Free

※ SP6002S8TG : Tube ; Pb – Free

### ABSOLUTE MAXIMUM RATINGS (T<sub>A</sub>=25°C, unless otherwise specified.)

The following ratings designate persistent limits beyond which damage to the device may occur.

Symbol	Parameter	Value	Unit
V <sub>dd</sub>	DC Supply Voltage	7	V
V <sub>SYNC</sub>	SYNC Voltage	7.5	V
I <sub>OUT</sub>	Peak Source Current (Pulsed)	1	A
	Peak Sink Current (Pulsed)	1.5	A
P <sub>D</sub>	Power Dissipation @ T <sub>A</sub> =85°C (*)	0.25	W
T <sub>J</sub>	Operating Junction Temperature Range	-40 to 150	°C
T <sub>STG</sub>	Storage Temperature Range	-40 to 150	°C
T <sub>LEAD</sub>	Lead Soldering Temperature for 5 sec.	260	°C



# SP6002

## Synchronous Rectifier Driver

### THERMAL RESISTANCE

Symbol	Parameter	Value	Unit
$R_{\theta JC}$	Thermal Resistance Junction – Case (*)	45	$^{\circ}\text{C}/\text{W}$

(\*) The power dissipation and thermal resistance are evaluated under copper board mounted with free air conditions.

### ELECTRICAL CHARACTERISTICS

( $T_A=25^{\circ}\text{C}$ ,  $V_{DD}=5\text{V}$ ,  $V_{sync}=5\text{V}$ , Freq. =300 KHz, Duty Cycle=50%, unless otherwise specified.)

Symbol	Parameter	Conditions	Min.	Typ.	Max.	Unit
<b>SUPPLY INPUT</b>						
$I_{DD}$	Supply current	No load	4	5.5	8	mA
$V_{onth}$	$V_{DD}$ turn on threshold (*)			5.0	7.0	V
$V_{offth}$	$V_{DD}$ turn off threshold		3.8	4.1		V
<b>SYNC REFERENCE (SYNC)</b>						
$V_{shth}$	SYNC high voltage		3.9	5.0		V
$V_{slth}$	SYNC low voltage			0.9	1.2	V
<b>MOSFET GATE DRIVER (MOSG-C &amp; MOSG-F)</b>						
$V_{oh}$	Output high voltage	$I_o = -200\text{mA}$	4.8	4.9	5.0	V
$V_{ol}$	Output low voltage	$I_o = 200\text{mA}$	0.0	0.1	0.2	V
$T_d$	Propagation delay	No load	15	20	25	ns
$T_r$	Rise time	Load = 1nF (**)	24	28	36	ns
$T_f$	Fall time	Load = 1nF (**)	20	23	30	ns
$T_{pred}$	Delay time	No load		100		ns

(\*) We have build in a diode from SYNC(pin8) to VDD(pin7).

(\*\*)  $T_r$  &  $T_f$  are measured among 10% and 90% of starting and final voltage.

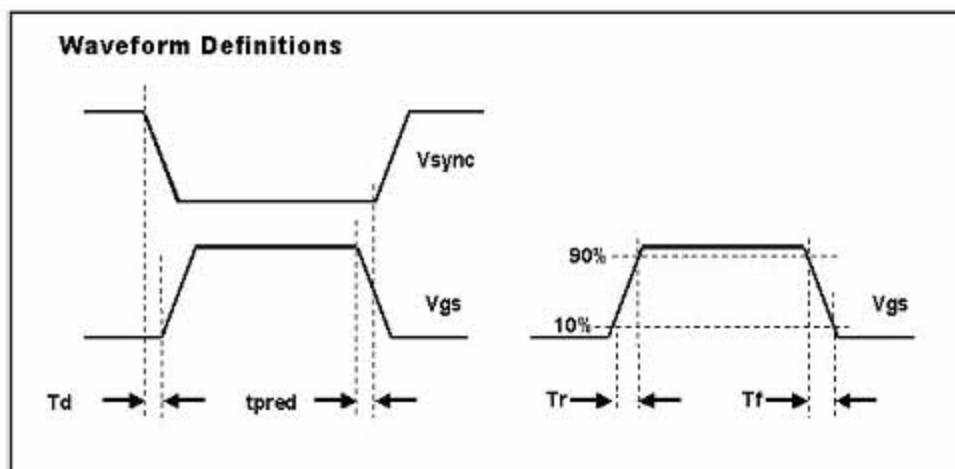

$V_{gs}$  = MOSG-C Output



# SP6002 Synchronous Rectifier Driver

PERFORMANCE CHARACTERISTICS ( $T_A=25^\circ\text{C}$ , unless otherwise specified.)

Figure 1: Supply Current vs Supply Voltage

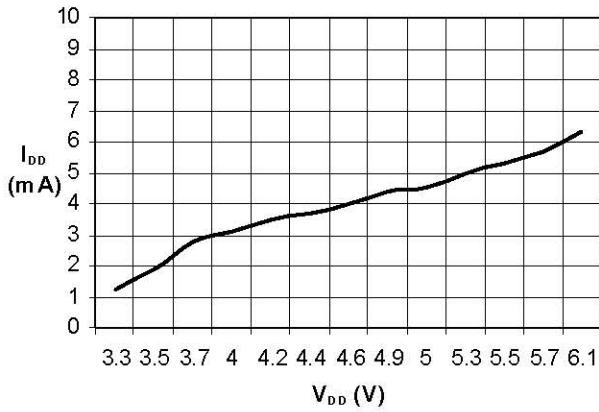

Figure 4: Supply Current vs Load Capacitor

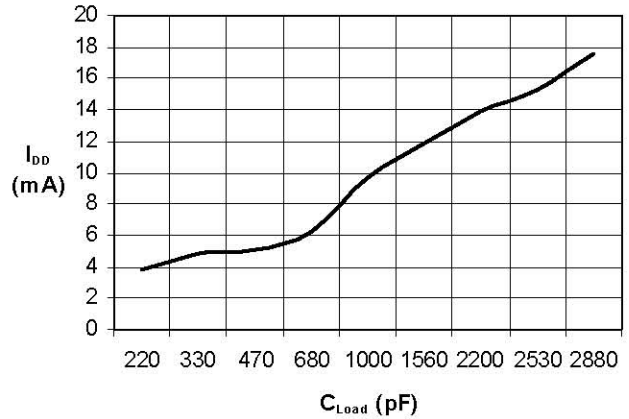

Figure 2: Output Rise Time vs Load Capacitor

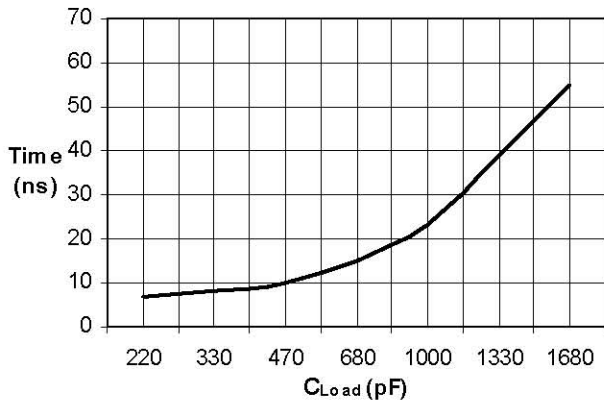

Figure 5: Supply Current vs Freq. @ No Load

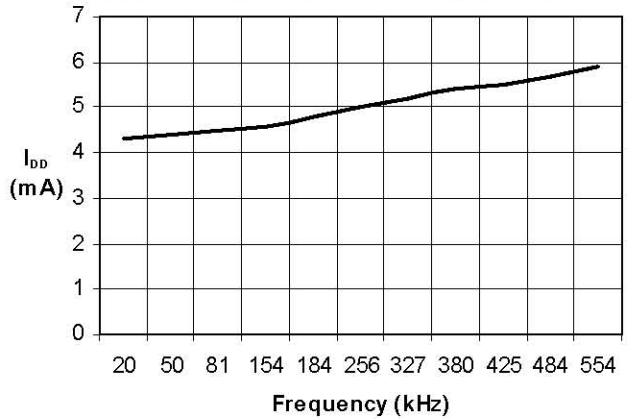

Figure 3: Output Fall Time vs Load Capacitor

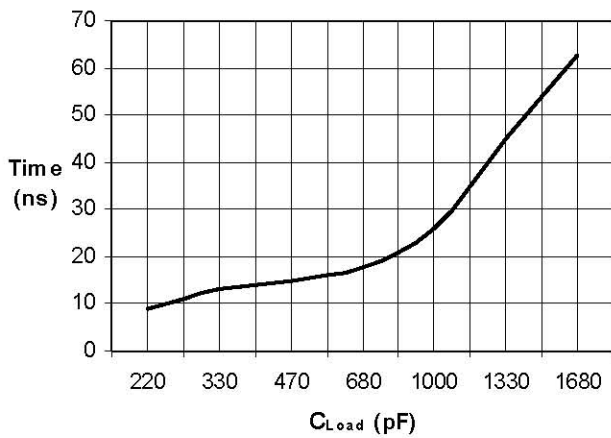
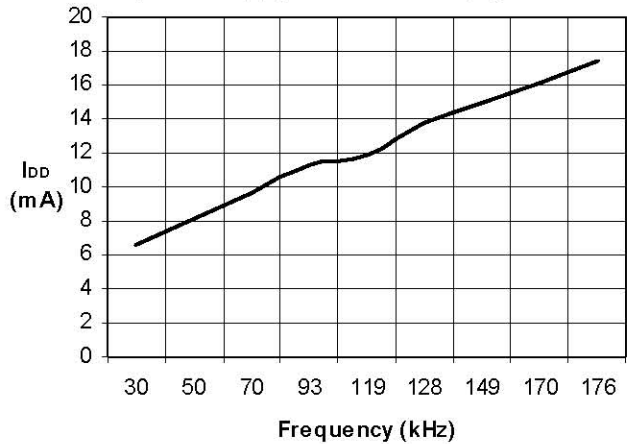

Figure 6: Supply Current vs Freq. @ Load=1nF





# SP6002

## Synchronous Rectifier Driver

### SOP- 8 PACKAGE OUTLINE

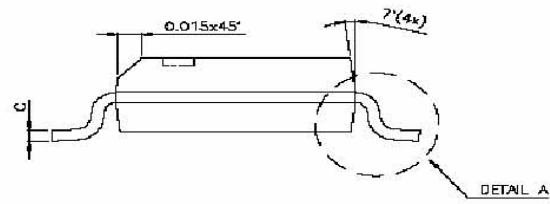
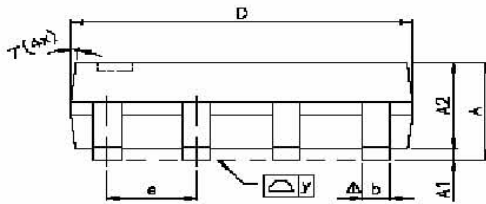
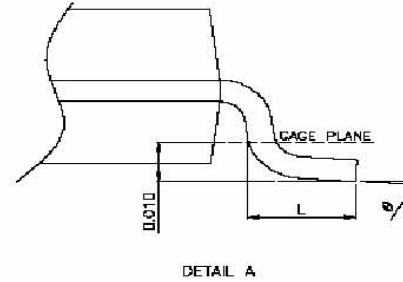
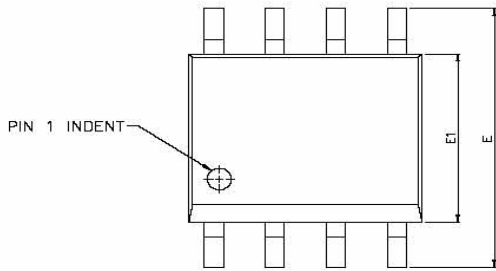

SYMBOLS	DIMENSIONS IN MILLIMETERS			DIMENSIONS IN INCHES		
	MIN	NOM	MAX	MIN	NOM	MAX
A	1.47	1.60	1.73	0.058	0.063	0.068
A1	0.10	—	0.25	0.004	—	0.010
A2	—	1.45	—	—	0.057	—
b	0.33	0.41	0.51	0.013	0.016	0.020
C	0.19	0.20	0.25	0.0075	0.008	0.0098
D	4.80	4.85	4.95	0.189	0.191	0.195
E	5.80	6.00	6.20	0.228	0.236	0.244
E1	3.80	3.90	4.00	0.150	0.154	0.157
e	—	1.27	—	—	0.050	—
L	0.38	0.71	1.27	0.015	0.028	0.050
$\Delta$ y	—	—	0.076	—	—	0.003
$\theta$	0°	—	8°	0°	—	8°