



AN2321 Application note

Reference design: high performance, L6599-based HB-LLC adapter with PFC for laptop computers

Introduction

This note describes the performances of a 90 W, wide-range mains, power-factor-corrected AC-DC adapter reference board. Its electrical specification is tailored on a typical hi-end portable computer power adapter. The peculiarities of this design are the very low no-load input consumption (<0.4 W) and the very high global efficiency.

The architecture is based on a two-stage approach: a front-end PFC pre-regulator based on the L6563 TM PFC controller and a downstream multi-resonant half-bridge converter that makes use of the new L6599 resonant controller. The Standby function of the L6599, pushing the DCDC converter upon recognition of a light load to work in burst mode and the logic dedicated to stop the PFC stage allows meeting the severe no-load consumption requirement.

The PFC TM operation and the top-level efficiency performance of the HB-LLC topology provide also a very good overall efficiency of the circuit.

L6599 & L6563 90W - adapter demo-board (EVAL6599-90W)

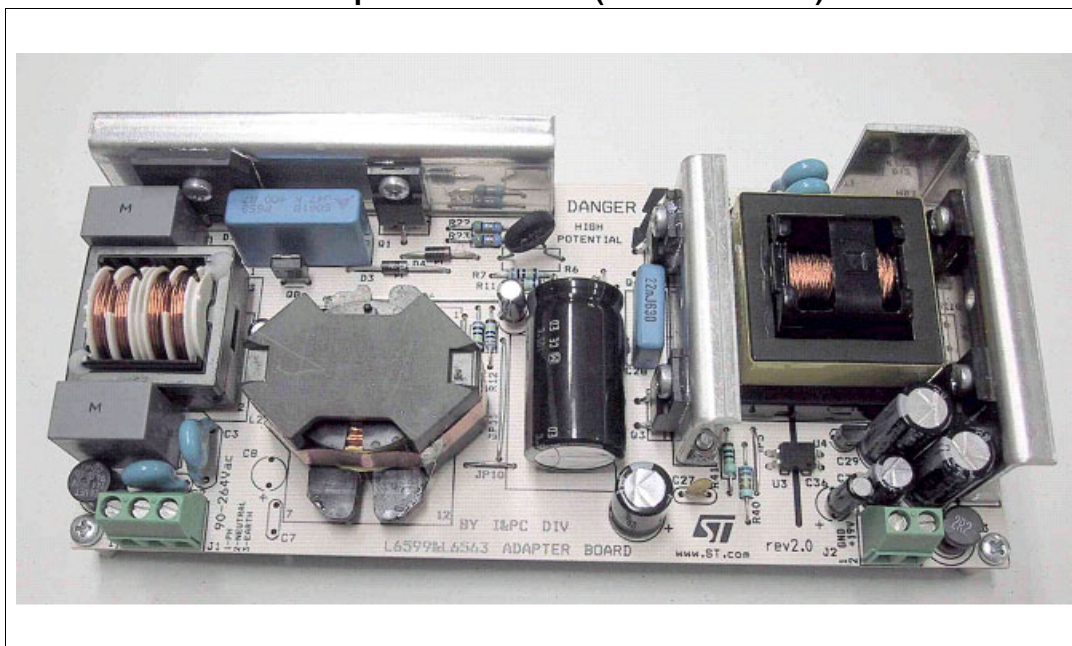

Contents

- 1 Main characteristics and circuit description 5**
- 2 Test results 7**
 - 2.1 Efficiency measurements 7
 - 2.2 Resonant stage operating waveforms 8
 - 2.3 Stand-by & no load power consumption 9
 - 2.4 Short circuit protection 12
 - 2.5 Over voltage protections 13
 - 2.6 Start-up sequence 13
- 3 Thermal tests 15**
- 4 Conducted emission pre-compliance test 17**
- 5 Bill of material 18**
- 6 PFC coil specification 23**
 - 6.1 Electrical characteristics 23
 - 6.2 Mechanical aspect and pin numbering 24
- 7 Resonant power transformer specification 25**
 - 7.1 Electrical characteristics 25
 - 7.2 Mechanical aspect and Pin numbering 26
- 8 PCB lay-out 27**
- 9 Revision history 28**

List of tables

Table 1.	Efficiency measurements - Vin=115Vac	7
Table 2.	Efficiency measurements - Vin=230Vac	7
Table 3.	Stand-by consumption - Vin=115Vac	11
Table 4.	Stand-by consumption - Vin=230Vac	11
Table 5.	Temperature of measured points @115Vac - full load	15
Table 6.	Temperature of measured points @230Vac - full load	16
Table 7.	Bill of material	18
Table 8.	Winding characteristics	23
Table 9.	Winding characteristics	25
Table 10.	Revision history	28

List of figures

Figure 1.	Electrical diagram	6
Figure 2.	Efficiency vs. Pout	8
Figure 3.	Resonant circuit primary side waveforms	8
Figure 4.	Resonant circuit secondary side waveforms	9
Figure 5.	Input power without load vs. mains voltage	10
Figure 6.	Waveforms at no-load operation	10
Figure 7.	Waveforms at no-load operation	10
Figure 8.	Load transition 0 ÷ 100%	11
Figure 9.	Load transition 100% ÷ 0	11
Figure 10.	O/P short circuit waveforms	12
Figure 11.	O/P short circuit waveforms (zoomed)	12
Figure 12.	Start-up @115Vac - Full load	13
Figure 13.	Start-up @115Vac - Full load	13
Figure 14.	Thermal map @115Vac - Full load	15
Figure 15.	Thermal map @230Vac - Full load	16
Figure 16.	CE peak measure at 115Vac and full load	17
Figure 17.	CE peak measure at 230Vac and full load	17
Figure 18.	Electrical diagram	23
Figure 19.	Bottom view	24
Figure 20.	Electrical diagram	25
Figure 21.	Pin lay-out, top view	26
Figure 22.	Thru-hole component placing and top silk screen	27
Figure 23.	SMT component placing and bottom silk screen	27
Figure 24.	Copper tracks	27

1 Main characteristics and circuit description

The main characteristics of the SMPS are listed here below:

- Universal input mains range: 90÷264Vac - frequency 45 to 65Hz
- Output voltage: 19V@4.7A continuous operation
- Mains harmonics: Compliance with EN61000-3-2 specifications
- Standby mains consumption: Typ. 0.4W @230Vac; Max 0.5W @265Vac
- Overall efficiency: better than 90%
- EMI: Compliance with EN55022-class B specifications
- Safety: Compliance with EN60950 specifications
- Low profile design: 25mm maximum height
- PCB single layer: 78x174 mm, mixed PTH/SMT technologies

The circuit consists of two stages: a front-end PFC implementing the L6563 and a resonant DC/DC converter based on the new resonant controller, the L6599. The Power Factor Corrected (PFC) stage delivers a stable 400 VDC and provides for the reduction of the mains harmonic, allowing to meet European standard EN61000-3-2. The controller is the L6563 (U1), working in transition mode and integrating all functions needed to control the PFC and interface the downstream resonant converter. The power stage of the PFC is a conventional boost converter, connected to the output of the rectifier bridge. It includes coil L2, diode D4 and capacitor C9. The boost switch is represented by the power MOSFET Q1. The L2 secondary winding (pins 8-10) is dedicated to provide to the L6563 the information about the PFC coil core demagnetization, necessary to the controller for the TM operation. The divider R1, R2 and R14 provides to the L6563 the information of the instantaneous voltage that is used to modulate the boost current, and to derive some further information like the average value of the AC line, used by the V_{FF} (voltage feed-forward) function. This function keeps the output voltage almost independent of the mains one. The divider R7, R8, R9, R10 detects the output voltage. The second divider R11, R12, R13 and R28 protects the circuit in case of voltage loop fail. The second stage is a resonant converter, half bridge topology, working in ZVS. The controller is the new L6599, incorporating the necessary functions to drive properly the Half-bridge by a 50 percent fixed duty cycle with dead-time, working with variable frequency.

The main features of the L6599 are a non-linear soft-start, a new current protection pin (ISEN, pin 6) that programs the hiccup mode timing, a dedicated pin for sequencing or brown-out (LINE) and a stand-by pin (STBY) for burst mode operation at light load. The transformer uses the integrated magnetic approach, incorporating the resonant series inductance. Thus, no any external additional coil is needed for the resonance. The transformer configuration chosen for the secondary winding is centre tap, using two Schottky rectifiers, type STPS10L60FP. The feedback loop is implemented by means of a typical circuit using a TL431 modifying the current in the optocoupler diode. The optocoupler transistor modulates the current from pin 4, so the frequency will change accordingly, thus achieving the output voltage regulation. Resistor R34 sets the maximum operating frequency and the load at which the controller starts to work in Burst mode. In case of a short circuit, the current into the primary winding is detected by the lossless circuit R41, C27, D11, D10, R39, and C25 and it is fed into the pin 6. In case of overload, the voltage on pin #6 will overpass an internal threshold that will trigger a protection sequence via pin #2, keeping the current flowing in the circuit at a safe level. In case of output voltage loop failure, the intervention of the zener diode connected to pin #8 (DIS) will activate the latched protection of the L6599. The DIS pin can be also activated by the L6563 via the PWM_LATCH pin in case of PFC loop failure.

Figure 1. Electrical diagram

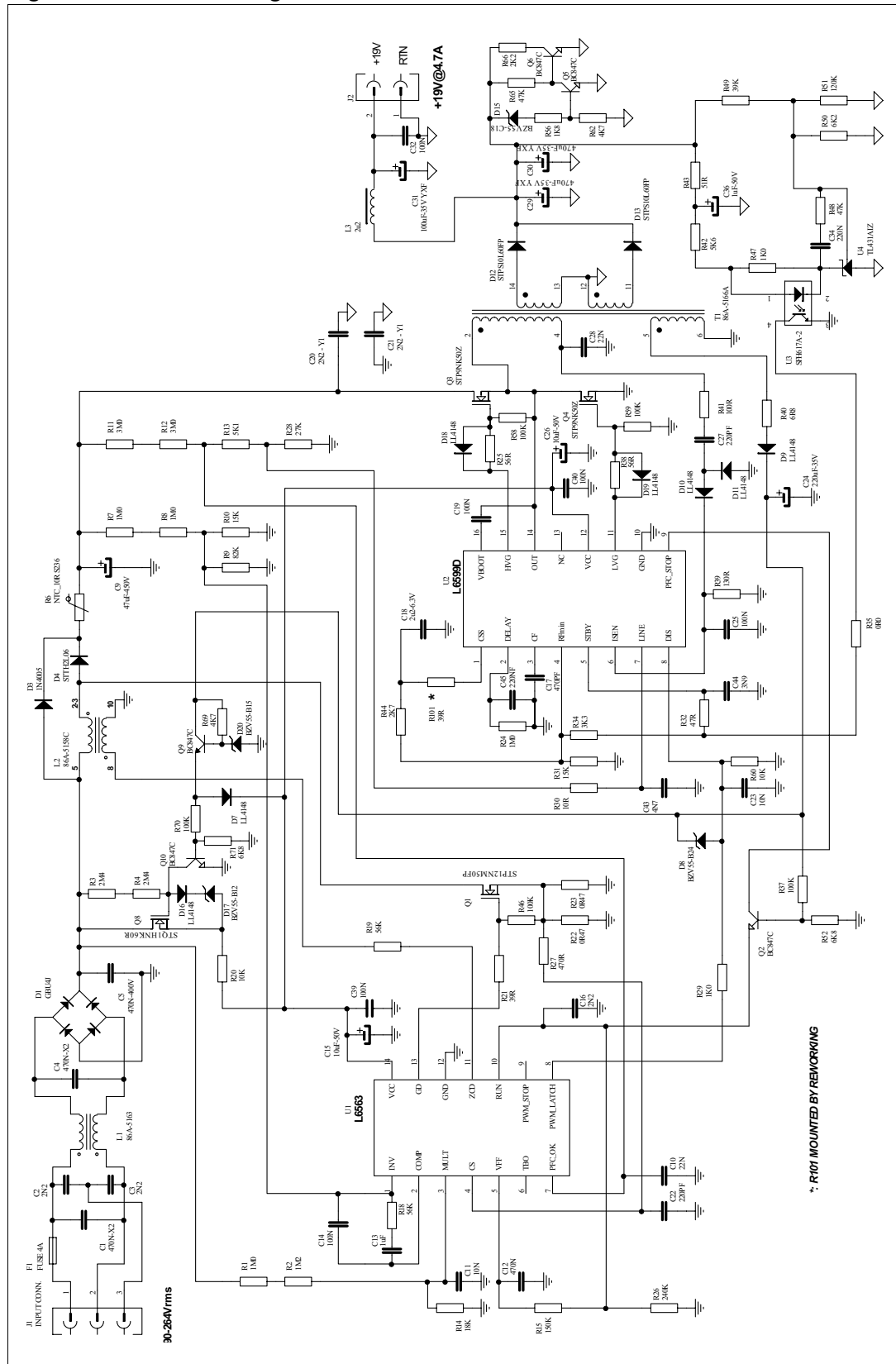

2 Test results

2.1 Efficiency measurements

[Table 1](#) and [Table 2](#) show the output voltage measurements at nominal mains with different load conditions. Efficiency is then calculated. For all measurements, both at full load and no load operation, the input power has been measured by a digital power meter, Yokogawa WT-210. Particular attention has to be paid when measuring input power at full load in order to avoid measurement errors due to the voltage drop on cables and connections. Therefore please connect the WT210 voltmeter termination to the board input connector. For the same reason please measure the output voltage at the output connector or use the remote detect option of your active load for a correct voltage measurement.

Table 1. Efficiency measurements - Vin=115Vac

Vout [V]	Iout [A]	Pout [W]	Pin [W]	Efficiency (%)
18.95	4.71	89.25	99.13	90.04
18.95	3.72	70.49	78.00	90.38
18.97	2.7	51.22	56.55	90.57
18.98	1.71	32.46	36.00	90.16
18.99	1.0	18.99	21.70	87.51
18.99	0.5	9.50	11.30	84.03
19.00	0.25	4.75	5.86	81.06

Table 2. Efficiency measurements - Vin=230Vac

Vout [V]	Iout [A]	Pout [W]	Pin [W]	Efficiency (%)
18.95	4.71	89.25	97.23	91.80
18.96	3.72	70.53	76.74	91.91
18.97	2.7	51.22	55.85	91.71
18.98	1.71	32.46	35.57	91.24
18.99	1.0	18.99	21.30	89.15
19.00	0.5	9.50	10.87	87.40
19.00	0.25	4.75	5.77	82.32

In [Table 1](#), [Table 2](#) and [Figure 2](#), the overall circuit efficiency is measured at different loads, powering the board at the two nominal input mains voltages. The measures have been done after 30 minutes of warm-up at maximum load. The high efficiency of the PFC working in transition mode and the very high efficiency of the resonant stage working in ZVS, provides for an overall efficiency better than 90%. This is a significant high number for a two-stage converter delivering an output current of 4.7 amps, especially at low input mains voltage where the PFC conduction losses increase. Even at lower loads, the efficiency remains still high.

Figure 2. Efficiency vs. Pout

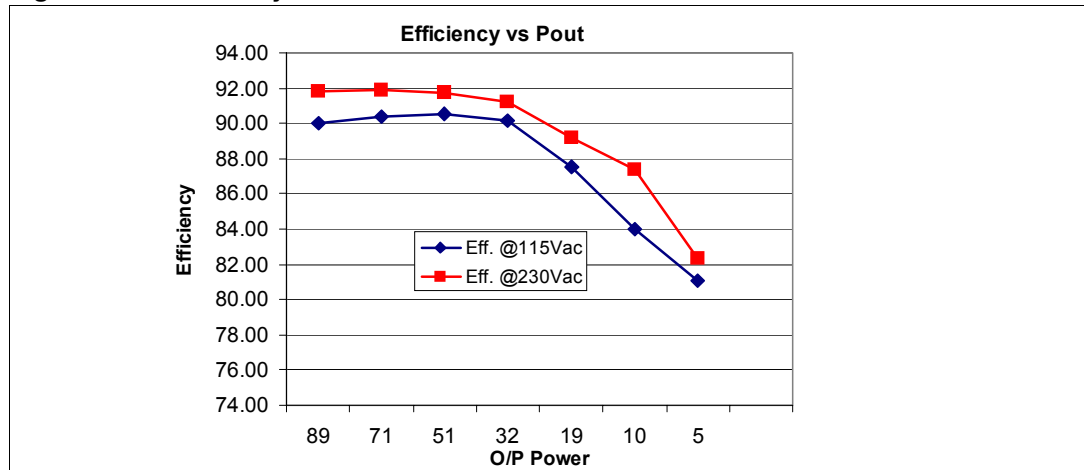

The global efficiency at full load has been measured with good results even at the limits of the input voltage range:

Vin = 90Vac - Full load

Vin = 264Vac - Full load

Pin = 100.5W

Pin = 96.3W

Efficiency = 88.9%

Efficiency = 92.6%

2.2 Resonant stage operating waveforms

Figure 3. Resonant circuit primary side waveforms

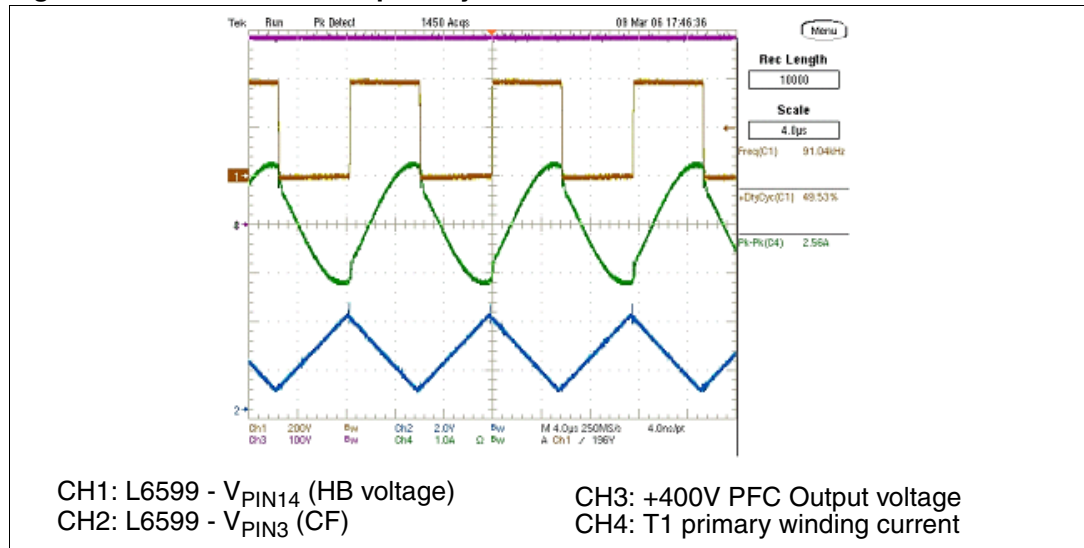

In *Figure 3* are reported some waveforms during steady state operation of the circuit at full load. The CH2 waveform is the oscillator signal at pin #3 of the L6599, while the CH3 waveform is the PFC output voltage, powering the resonant stage. The CH1 trace is the half bridge waveform, driving the resonant circuit. In the picture it is not obvious, but the switching frequency is normally slightly modulated following the PFC 100Hz ripple that is rejected by the resonant control circuitry. The switching frequency has been chosen around 90 kHz, in order to have a good trade off between transformer losses and its dimensions.

The transformer primary current wave shape is the CH4 trace. As shown, it is almost sinusoidal, because the operating frequency is slightly above the resonance of the leakage inductance and the resonant capacitor (C28).

In this condition, the circuit has a good margin for ZVS operations providing good efficiency and the almost sinusoidal wave shape provides for an extremely low EMI generation.

Figure 4. Resonant circuit secondary side waveforms

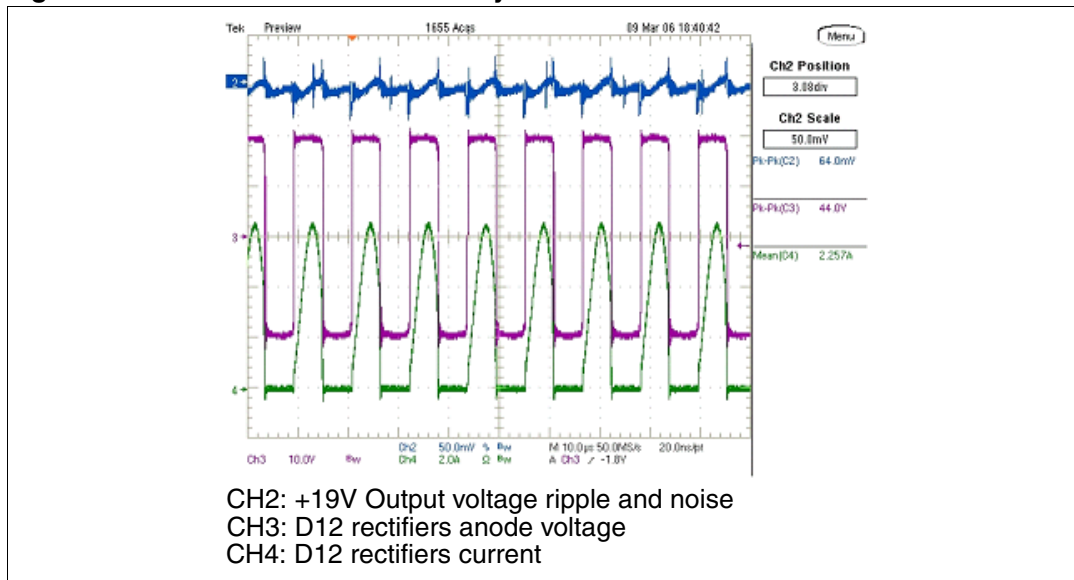

In *Figure 4*, are represented some waveforms relevant to the secondary side: the rectifiers reverse voltage is measured by CH3 and the peak to peak value is indicated on the right of the picture. It is a bit higher than the theoretical value that would be $2(V_{OUT}+V_F)$, hence about 40V. It is possible to observe a small ringing on the bottom side of the waveform, responsible for this difference. The channel CH4 (green in the picture) shows the current in the diode D12, equal to that one flowing in D13. Even this current shape is almost a sine wave, its average value is half of the output current. The ripple and noise on the output voltage is measured by CH2.

Thanks to the advantages of the resonant converter, the high frequency ripple and noise of the output voltage is only 100mV (0.52%) including spikes, while the residual ripple at mains frequency is 130mV at maximum load and any line condition.

2.3 Stand-by & no load power consumption

The board is specifically designed for light load and zero load operation, like during operation with load disconnected. The results are reported in the diagram of *Figure 5*, here following. As highlighted in the diagram of *Figure 4*, the input power at no load is always below 0.4W for any input mains voltage. Thanks to the L6599 stand-by function, at light load conditions both the resonant converter and the PFC work skipping switching cycles, according to the load. In fact, the L6599 via the PFC_STOP pin (#9) stops the operation of the L6563 during the burst mode off-time.

Figure 5. Input power without load vs. mains voltage

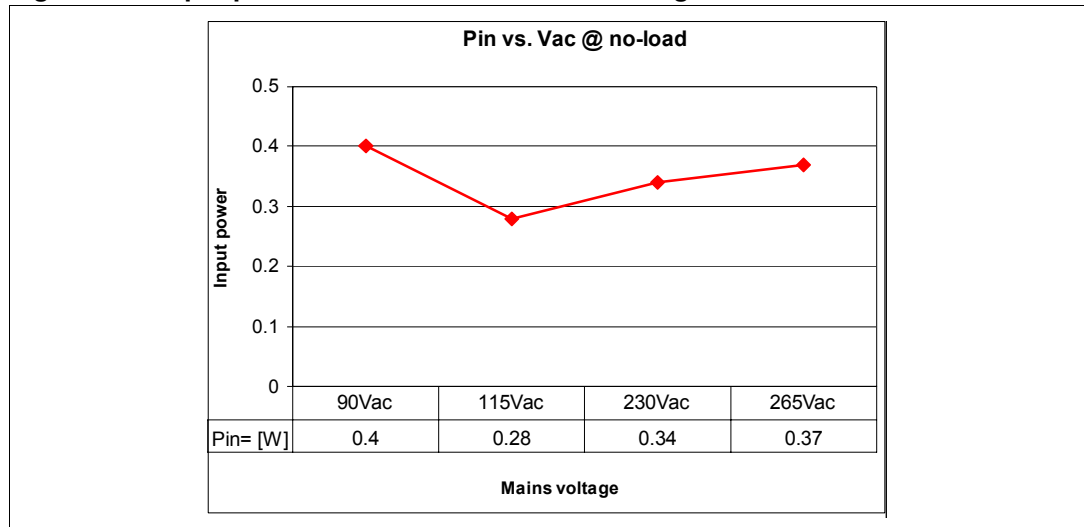

The result is visible in [Figure 6](#): the two converters are now working for a very short time, the output voltage is perfectly regulated at its nominal value, with just a negligible residual ripple over imposed (~140mV). Thanks to the burst mode and the reduced number of switching cycles the relevant losses are drastically reduced, therefore input power drawn from the mains is very low. However, if the output voltage has a sudden load change, both converters are ready to react immediately, thus avoiding output voltage drops. In [Figure 7](#) the details of the waveforms captured in [Figure 6](#) show some details during the switching period and additionally, the L6563 RUN pin (#10) signal is captured. This pin is connected to the PFC_STOP pin (#9) of the L6599 and enables the operation of the PFC during the burst pulse of the resonant.

Figure 6. Waveforms at no-load operation

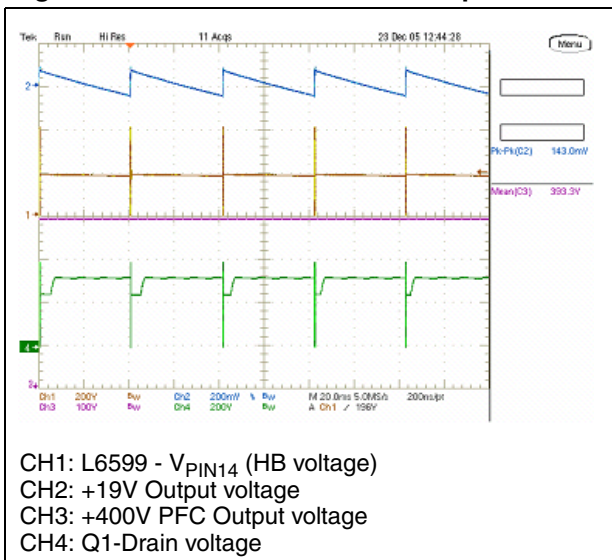
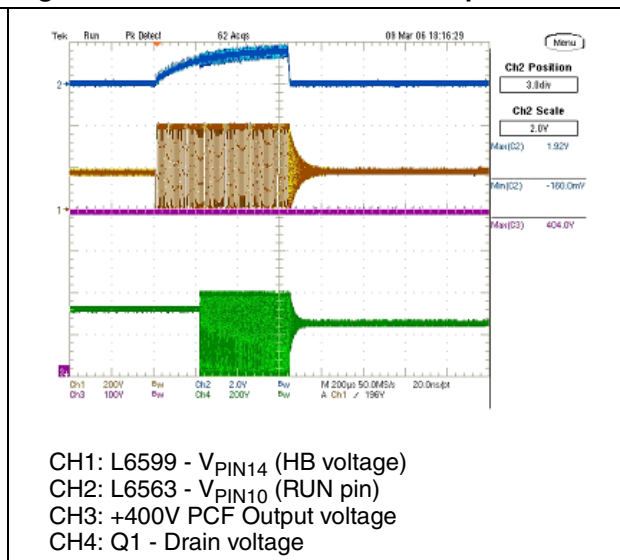

Figure 7. Waveforms at no-load operation



[Table 3](#) and [Table 4](#) report the measurements of the input power during operation as a function of the output power. Even with reduced load operation, the burst mode functionality allows to work with good circuit efficiency.

Table 3. Stand-by consumption - Vin=115Vac

Vout [V]	Iout [mA]	Pout [W]	Pin [W]
19.01	80	1.5	3
19.01	53	1	2
19.01	27	0.5	1.08
19.01	13	0.25	0.66

Table 4. Stand-by consumption - Vin=230Vac

Vout [V]	Iout [mA]	Pout [W]	Pin [W]
19.01	80	1.5	2.4
19.01	53	1	1.68
19.01	27	0.5	1
19.01	13	0.25	0.67

Figure 8 shows the waveforms of the output voltage and current during a load variation from 0 to 100%. During operation at zero load, the circuit is working in burst mode as described before then, as soon as the load increases it works in continuous switching operation. As shown, due to the fact that the PFC is always operating, the circuit response is fast enough to avoid output voltage dips. In Figure 9, the opposite load transition is checked (100% to 0). Even in this case the transition is clean and doesn't show any problem for the output voltage regulation.

Thus, it is clear that the proposed architecture is the most suitable for power supply operating with strong load variation without any problem related to the load regulation.

Figure 8. Load transition 0 ÷ 100%

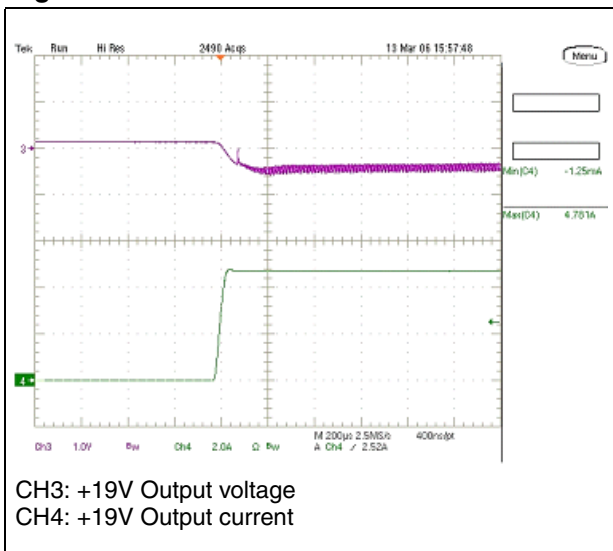
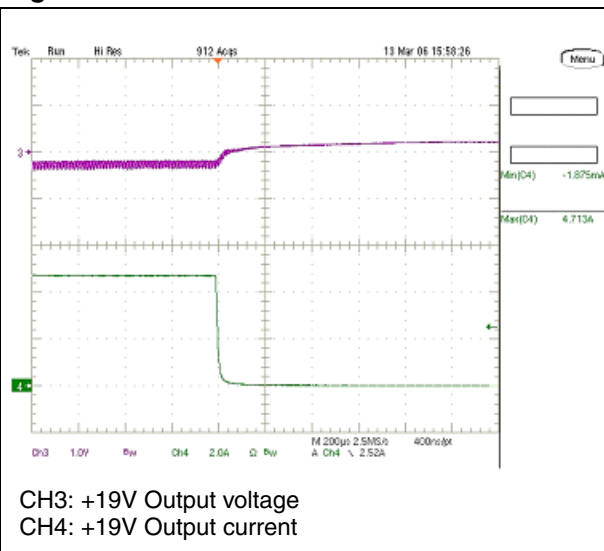

Figure 9. Load transition 100% ÷ 0



2.4 Short circuit protection

The L6599 is equipped with a current sensing input (pin #6, ISEN) and a dedicated over current management system. The current flowing in the circuit is detected and the signal is fed into the ISEN pin. It is internally connected to the input of a first comparator, referenced to 0.8V, and to that of a second comparator referenced to 1.5V. If the voltage externally applied to the pin by either circuit in [Figure 8](#) exceeds 0.8V, the first comparator is tripped causing an internal switch to be turned on and discharging the soft-start capacitor CSS.

Under output short circuit, this operation results in a nearly constant peak primary current. With the L6599 the designer can program externally the maximum time (TSH) that the converter is allowed to run overloaded or under short circuit conditions. Overloads or short circuits lasting less than TSH will not cause any other action, hence providing the system with immunity to short duration phenomena. If, instead, TSH is exceeded, an overload protection (OLP) procedure is activated that shuts down the L6599 and, in case of continuous overload/short circuit, results in continuous intermittent operation with a user-defined duty cycle. This function is realized with the pin DELAY (#2), by means of a capacitor C45 and the parallel resistor R24 connected to ground. As the voltage on the ISEN pin exceeds 0.8V the first OCP comparator, in addition to discharging CSS, turns on an internal current generator that via the DELAY pin charges C45. As the voltage on C45 is 3.5V, the L6599 stops switching and the PFC_STOP pin is pulled low. Also the internal generator is turned off, so that C45 will now be slowly discharged by R24. The IC will restart when the voltage on C45 will be less than 0.3V. Additionally, if the voltage on the ISEN pin reaches 1.5V for any reason (e.g. transformer saturation), the second comparator will be triggered, the L6599 will shutdown and the operation will be resumed after an on-off cycle.

Figure 10. O/P short circuit waveforms

Figure 11. O/P short circuit waveforms (zoomed)

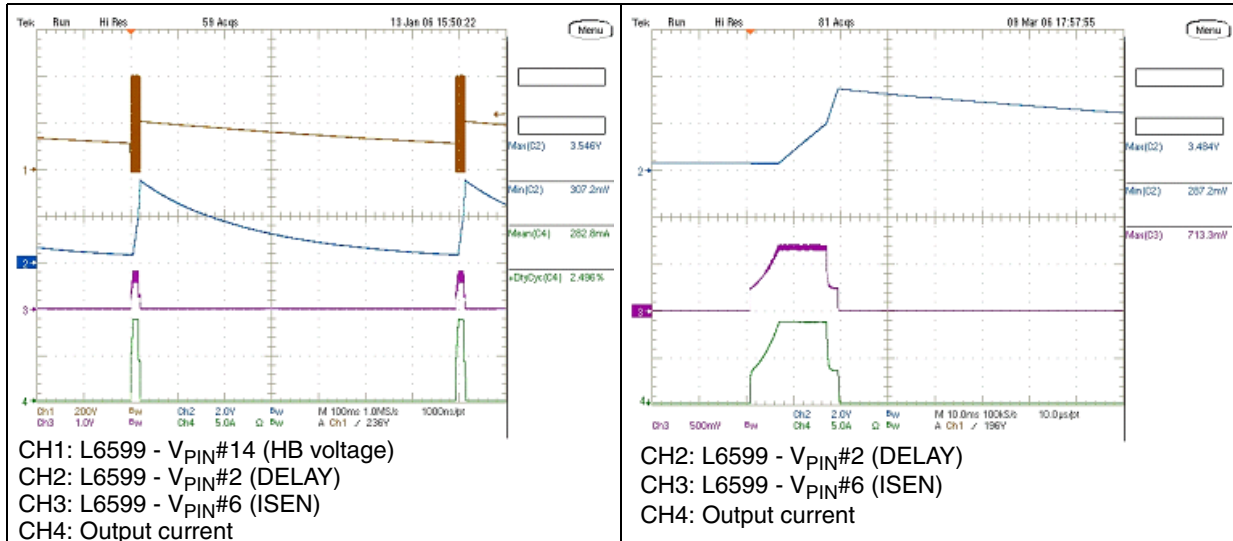

The L6599 short circuit protection sequence described above is visible in the [Figure 10](#). The on/off operation is controlled by the voltage on pin #2 (DELAY), providing for the hiccup mode of the circuit.

Thanks to this control pin, the designer can select the hiccup mode timing and thus keep the average output current at a safe level. Please note on the picture left side the very low mean current flowing in the shorted output, less than 0.3 A. A better detail of the waveforms can

be appreciated in [Figure 11](#) where it is possible to recognize the operation phases described above.

2.5 Over voltage protections

Both circuit stages, PFC and resonant, are equipped with their own over voltage protection. The PFC controller L6563 is internally equipped with a dynamic and a static over voltage protection circuit detecting the error amplifier via the voltage divider dedicated to the feedback loop to detect the PFC output voltage. In case the internal threshold is exceeded, the IC limits the voltage to a programmable, safe value. Moreover, in the L6563 there is an additional protection against loop failures using an additional divider (R11, R12, R13, R28) connected to a dedicated pin (PFC_OK, #7) protecting the circuit in case of loop failures, disconnection or deviation from the nominal value of the feedback loop divider. Hence the PFC output voltage is always under control and in case a fault condition is detected the PFC_OK circuitry will latch the L6563 operations and, by means of the PWM_LATCH pin (#8) it will latch the L6599 as well via the pin #8 (DIS).

The pin DIS is also used to protect the resonant stage against over voltage or loop disconnections. In fact, the zener diode D8 connected to pin DIS detects the voltage and in case of open loop it will conduct and voltage on pin DIS will exceed the internal threshold. Then the IC will be immediately shut down and its consumption reduced at a low value. This state will be latched and will be necessary to let the voltage on the Vcc pin go below the UVLO threshold to reset the latch and restart the IC operation.

2.6 Start-up sequence

Figure 12. Start-up @115Vac - Full load

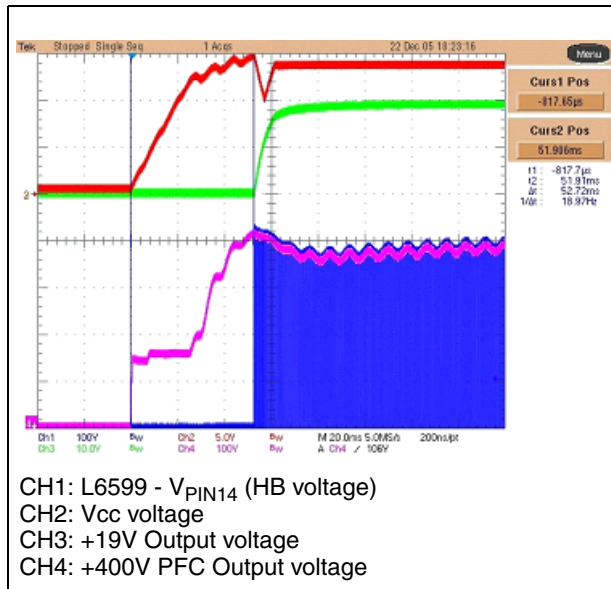
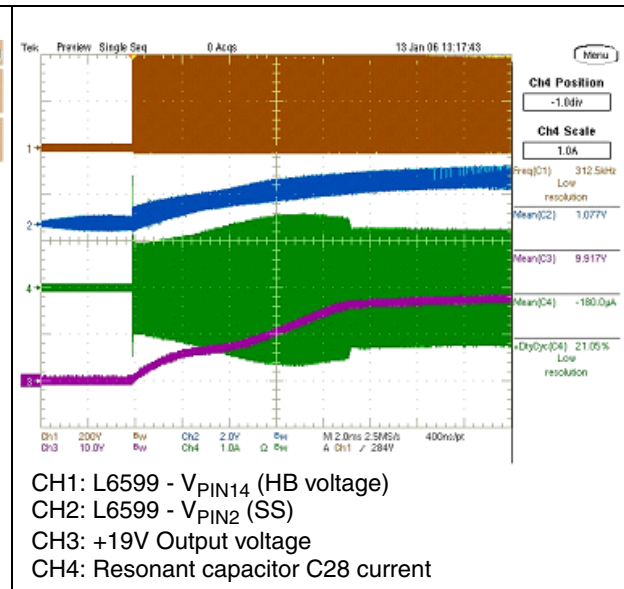

Figure 13. Start-up @115Vac - Full load



[Figure 12](#) shows the waveforms during the start at 90Vac and full load. It is possible to note the sequence of the two stages: at power on the L6563 and L6599 Vcc voltages increase up to the turn-on thresholds of the two ICs. The PFC starts and its output voltage increases from the mains rectified voltage to its nominal value, with a small overshoot. In the meantime the L6599 is kept inactive by the LINE pin (#7) until the PFC voltage reaches the threshold

set by the divider R11, R12, R13, R28. As soon as it reaches the L6599 LINE pin threshold, the resonant starts to operate. Hence the output voltage rises according to the soft-start and reaches the nominal level. This sequence provides for the advantages of a perfect sequencing of the circuit at start-up with the PFC acting as master and avoids complex additional circuitry for the correct start-up of the circuit in all conditions. The circuit has been tested in all line and load conditions showing a correct start-up sequence. The used high voltage start-up circuit used avoids useless power dissipation during light load operation and provides for an almost constant wake-up time of the circuit.

In [Figure 13](#), the L6599 start-up sequence is analyzed: as soon as the LINE pin (#7) enables the operation of the L6599 converter's soft start-up sequence is triggered therefore initially, the capacitor C18 is totally discharged, and the resistor R44 is effectively in parallel to R24 thus the resulting initial frequency is determined by R_{SS} and R_{Fmin} only, since the optocoupler's phototransistor is off (as long as the output voltage is not too far away from the regulated value). C18 is progressively charged until its voltage reaches the reference voltage (2 V) and, consequently, the current through R44 goes to zero.

During this frequency sweep the operating frequency will decrease following the exponential charge of C18 that will count balance the non-linear frequency dependence of the tank circuit. As a result, the average input current will smoothly increase, without the peaking that occurs with linear frequency sweep, and the output voltage will reach the regulated value with almost no overshoot as the waveforms in the picture.

3 Thermal tests

In order to check the design reliability, a thermal mapping by means of an IR Camera was done. Here below the thermal measures of the board, component side, at nominal input voltage are shown. Some pointers visible on the pictures have been placed across key components or components showing high temperature. The correlation between measurement points and components is indicated below, for both diagrams.

Figure 14. Thermal map @115Vac - Full load

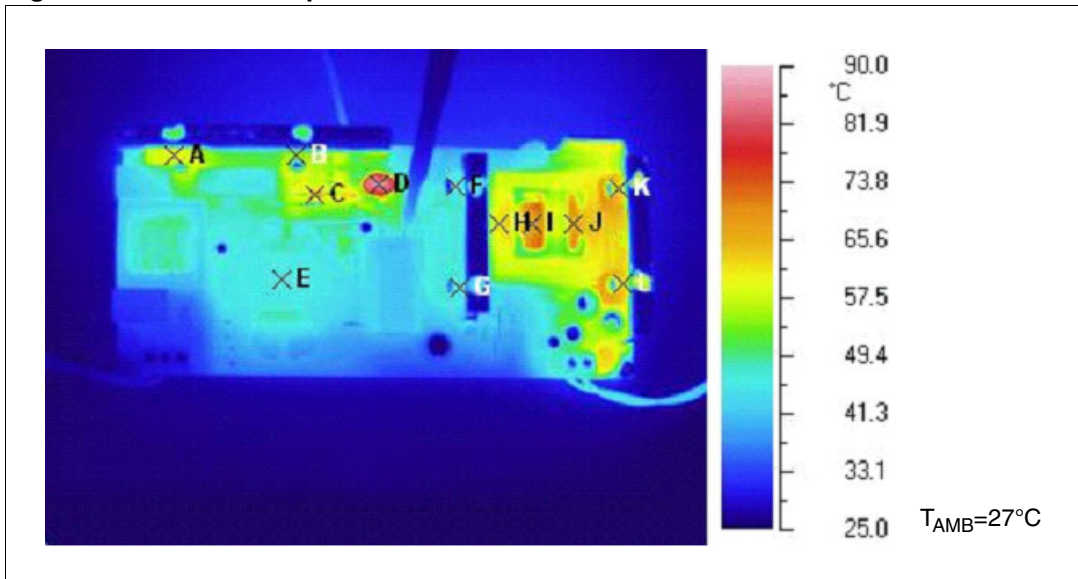

Table 5. Temperature of measured points @115Vac - full load

Points - Ref.	Temp
A - D1	59.1°C
B - Q1	54.0°C
C - D4	67.6°C
D - R6	85.8°C
E - L2	45.7°C
F - Q4	46.2°C
G - Q3	46.5°C
H - T1 _{CORE}	61.8°C
I - T1 _{PR}	67.2°C
J - T1 _{SEC}	67.4°C
K - D12	62.8°C
L - D13	62.8°C

Figure 15. Thermal map @230Vac - Full load

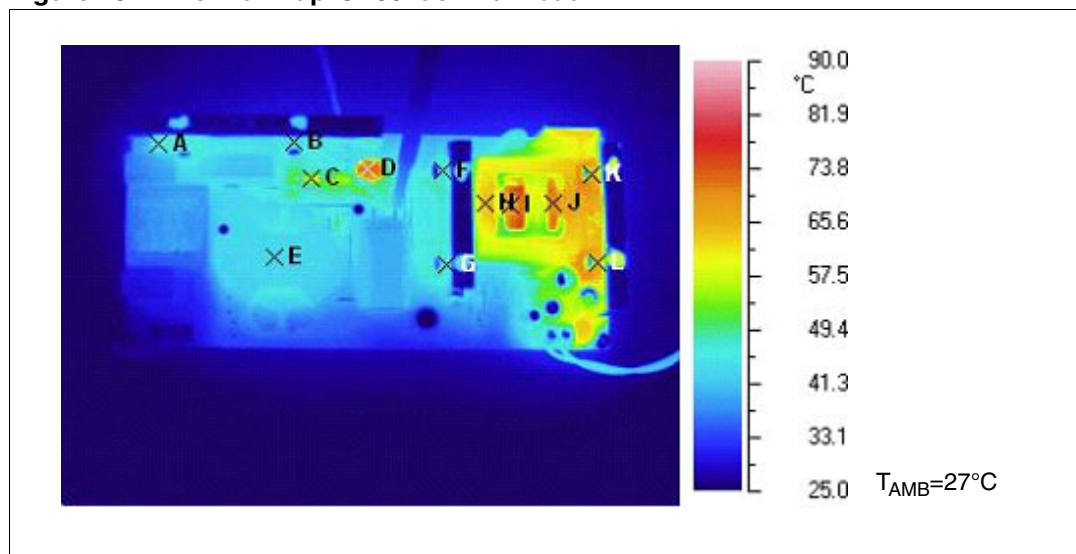

Table 6. Temperature of measured points @230Vac - full load

Points - Ref.	Temp
A - D1	45.9°C
B - Q1	44.3°C
C - D4	59.0°C
D - R6	72.4°C
E - L2	43.7°C
F - Q4	46.8°C
G - Q3	46.5°C
H - T1 _{CORE}	63.7°C
I - T1 _{PR}	67.9°C
J - T1 _{SEC}	69.5°C
K - D12	64.8°C
L - D13	64.9°C

All other components of the board are working within the temperature limits, assuring a reliable long term operation of the power supply.

4 Conducted emission pre-compliance test

The limits indicated on both diagrams at 115Vac and 230Vac comply with EN55022 Class-B specifications. The values are measured in peak detection mode.

Figure 16. CE peak measure at 115Vac and full load

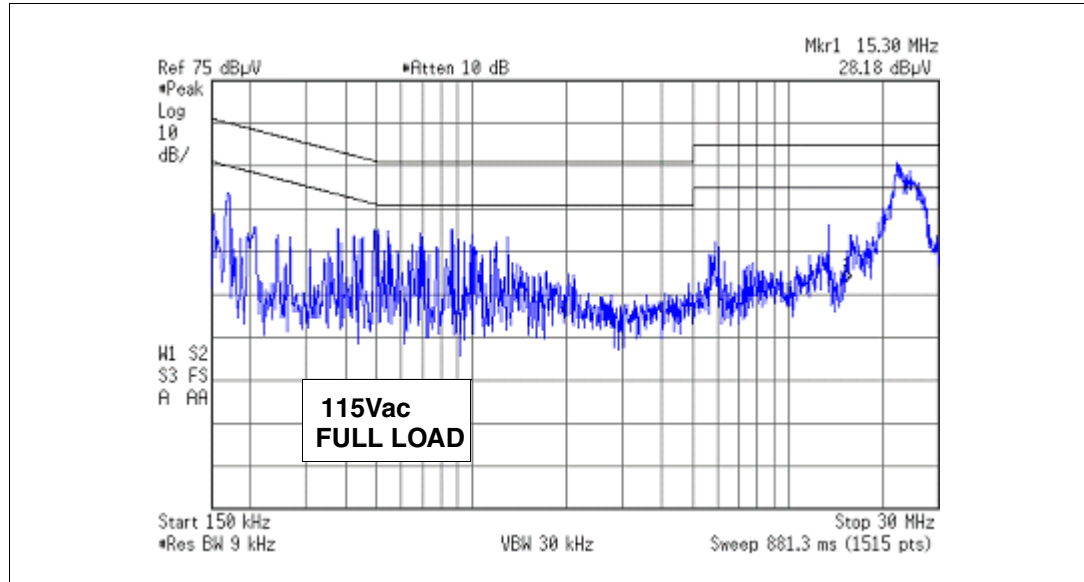
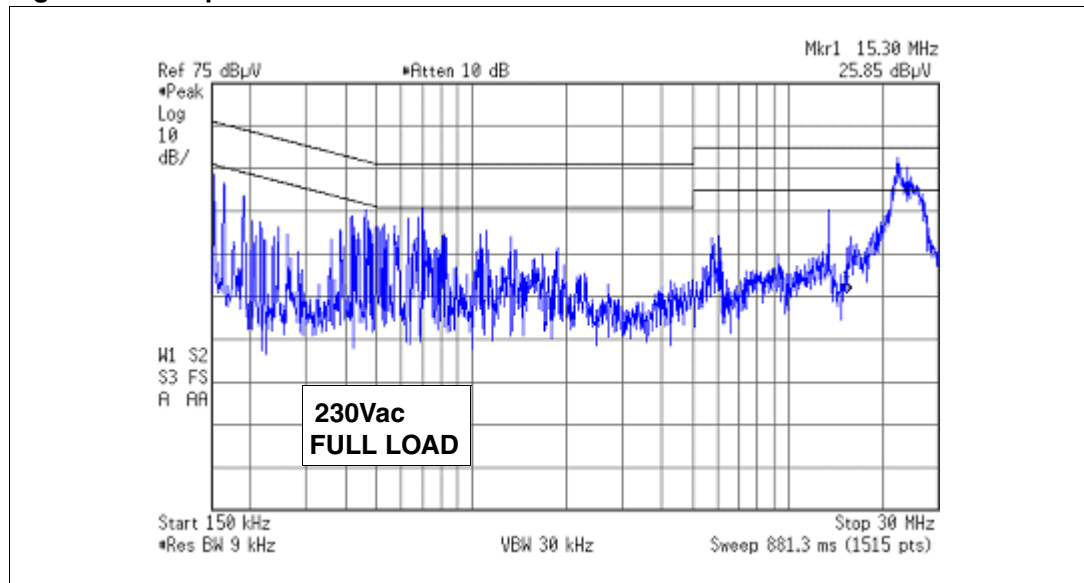

Figure 17. CE peak measure at 230Vac and full load



5 Bill of material

Table 7. Bill of material

Res. Des.	Part Type/ Part Value	Description	Supplier
C1	470N-X2	X2 FILM CAPACITOR - R46-I 3470--M1-	RUBYCON
C1	470N-X2	X2 FILM CAPACITOR - R46-I 3470--M1-	ARCOTRONICS
C10	22N	50V CERCAP - GENERAL PURPOSE	AVX
C11	10N	50V CERCAP - GENERAL PURPOSE	AVX
C12	470N	25V CERCAP - GENERAL PURPOSE	AVX
C13	1uF	25V CERCAP - GENERAL PURPOSE	AVX
C14	100N	50V CERCAP - GENERAL PURPOSE	AVX
C15	10uF-50V	ALUMINIUM ELCAP - YXF SERIES - 105°C	RUBYCON
C16	2N2	50V CERCAP - GENERAL PURPOSE	AVX
C17	470PF	50V - 5% - C0G - CERCAP	AVX
C18	2uF2-6.3V	25V CERCAP - GENERAL PURPOSE	AVX
C19	100N	50V CERCAP - GENERAL PURPOSE	AVX
C2	2N2	Y1 SAFETY CAP.	MURATA
C20	2N2 - Y1	DE1E3KX222M - Y1 SAFETY CAP.	MURATA
C21	2N2 - Y1	DE1E3KX222M - Y1 SAFETY CAP.	MURATA
C22	220PF	50V CERCAP - GENERAL PURPOSE	AVX
C23	10N	50V CERCAP - GENERAL PURPOSE	AVX
C24	220uF-35V	ALUMINIUM ELCAP - YXF SERIES - 105°C	RUBYCON
C25	100N	50V CERCAP - GENERAL PURPOSE	AVX
C26	10uF-50V	ALUMINIUM ELCAP - YXF SERIES - 105°C	RUBYCON
C27	220PF	500V CERCAP - 5MQ221KAAAA	AVX
C28	22N	630V - PHE450MA5220JR05	EVOX-RIFA
C29	470uF-35V YXF	ALUMINIUM ELCAP - YXF SERIES - 105°C	RUBYCON
C3	2N2	Y1 SAFETY CAP.	MURATA
C30	470uF-35V YXF	ALUMINIUM ELCAP - YXF SERIES - 105°C	RUBYCON
C31	100uF-35V YXF	ALUMINIUM ELCAP - YXF SERIES - 105°C	RUBYCON
C32	100N	50V CERCAP - GENERAL PURPOSE	AVX
C34	220N	50V CERCAP - GENERAL PURPOSE	AVX
C36	1uF-50V	ALUMINIUM ELCAP - YXF SERIES - 105°C	RUBYCON
C39	100N	50V CERCAP - GENERAL PURPOSE	AVX
C4	470N-X2	X2 FILM CAPACITOR - R46-I 3470--M1-	ARCOTRONICS
C40	100N	50V CERCAP - GENERAL PURPOSE	AVX

Table 7. Bill of material (continued)

Res. Des.	Part Type/ Part Value	Description	Supplier
C43	4N7	50V CERCAP - GENERAL PURPOSE	AVX
C44	3N9	50V CERCAP - GENERAL PURPOSE	AVX
C45	220NF	25V CERCAP - GENERAL PURPOSE	AVX
C5	470N-400V	PHE426KD6470JR06L2 - POLYPROP. FILM CAP	EVOX-RIFA
C9	47uF-450V	ALUMINIUM ELCAP - ED SERIES - 105°C	PANASONIC
D1	GBU4J	SINGLE PHASE BRIDGE RECTIFIER	VISHAY
D10	LL4148	FAST SWITCHING DIODE	VISHAY
D11	LL4148	FAST SWITCHING DIODE	VISHAY
D12	STPS10L60FP	POWER SCHOTTKY RECTIFIER	STMicroelectronics
D13	STPS10L60FP	POWER SCHOTTKY RECTIFIER	STMicroelectronics
D15	BZV55-C18	ZENER DIODE	VISHAY
D16	LL4148	FAST SWITCHING DIODE	VISHAY
D17	BZV55-C12	ZENER DIODE	VISHAY
D18	LL4148	FAST SWITCHING DIODE	VISHAY
D19	LL4148	FAST SWITCHING DIODE	VISHAY
D20	BZV55-B15	ZENER DIODE	VISHAY
D3	1N4005	GENERAL PURPOSE RECTIFIER	VISHAY
D4	STTH2L06	ULTRAFast HIGH VOLTAGE RECTIFIER	STMicroelectronics
D7	LL4148	FAST SWITCHING DIODE	VISHAY
D8	BZV55-B24	ZENER DIODE	VISHAY
D9	LL4148	FAST SWITCHING DIODE	VISHAY
F1	FUSE 4A	FUSE T4A - TIME DELAY	WICHMANN
HS1		HEAT SINK FOR D1&Q1	DWG
HS2		HEAT SINK FOR Q3&Q4	DWG
HS3		HEAT SINK FOR D12&D13	DWG
J1	MKDS 1,5/ 3-5,08	PCB TERM. BLOCK, SCREW CONN.- 3 W.	PHOENIX CONTACT
J2	MKDS 1,5/ 2-5,08	PCB TERM. BLOCK, SCREW CONN.- 2 W.	PHOENIX CONTACT
L1	86A-5163	INPUT EMI FILTER	DELTA ELECTRONICS
L2	86A-5158C	PFC INDUCTOR	DELTA ELECTRONICS
L3	RFB0807-2R2	2u2 - RADIAL INDUCTOR	COILCRAFT
Q1	STP12NM50FP	N-CHANNEL POWER MOSFET	STMicroelectronics
Q10	BC847C	NPN SMALL SIGNAL BJT	STMicroelectronics
Q2	BC847C	NPN SMALL SIGNAL BJT	STMicroelectronics
Q3	STP9NK50ZFP	N-CHANNEL POWER MOSFET	STMicroelectronics

Table 7. Bill of material (continued)

Res. Des.	Part Type/ Part Value	Description	Supplier
Q4	STP9NK50ZFP	N-CHANNEL POWER MOSFET	STMicroelectronics
Q5	BC847C	NPN SMALL SIGNAL BJT	STMicroelectronics
Q6	BC847C	NPN SMALL SIGNAL BJT	STMicroelectronics
Q8	STQ1HNK60R	N-CHANNEL POWER MOSFET	STMicroelectronics
Q9	BC847C	NPN SMALL SIGNAL BJT	STMicroelectronics
R1	1M0	SMD STANDARD FILM RES - 1/4W - 5% - 250ppm/°C	BC COMPONENTS
R10	15K	SMD STANDARD FILM RES - 1/8W - 1% - 100ppm/°C	BC COMPONENTS
R11	3M0	MBB0207 AXIAL FILM RES - 0.4W - 1% - 50ppm/°C	BC COMPONENTS
R12	3M0	MBB0207 AXIAL FILM RES - 0.4W - 1% - 50ppm/°C	BC COMPONENTS
R13	8K2	SMD STANDARD FILM RES - 1/8W - 1% - 100ppm/°C	BC COMPONENTS
R14	18K	SMD STANDARD FILM RES - 1/4W - 5% - 250ppm/°C	BC COMPONENTS
R15	150K	SMD STANDARD FILM RES - 1/8W - 5% - 250ppm/°C	BC COMPONENTS
R18	56K	SMD STANDARD FILM RES - 1/8W - 5% - 250ppm/°C	BC COMPONENTS
R19	56K	SMD STANDARD FILM RES - 1/8W - 5% - 250ppm/°C	BC COMPONENTS
R2	1M2	SMD STANDARD FILM RES - 1/4W - 5% - 250ppm/°C	BC COMPONENTS
R20	10K	SMD STANDARD FILM RES - 1/4W - 5% - 250ppm/°C	BC COMPONENTS
R21	39R	SMD STANDARD FILM RES - 1/4W - 5% - 250ppm/°C	BC COMPONENTS
R22	0R47	SFR25 AXIAL STAND. FILM RES - 0.4W - 5% - 250ppm/°C	BC COMPONENTS
R23	0R47	SFR25 AXIAL STAND. FILM RES - 0.4W - 5% - 250ppm/°C	BC COMPONENTS
R24	1M0	SMD STANDARD FILM RES - 1/4W - 5% - 250ppm/°C	BC COMPONENTS
R25	56R	SMD STANDARD FILM RES - 1/8W - 5% - 250ppm/°C	BC COMPONENTS
R26	240K	SMD STANDARD FILM RES - 1/8W - 5% - 250ppm/°C	BC COMPONENTS
R27	470R	SMD STANDARD FILM RES - 1/4W - 5% - 250ppm/°C	BC COMPONENTS
R28	24K9	SMD STANDARD FILM RES - 1/8W - 1% - 100ppm/°C	BC COMPONENTS
R29	1K0	SMD STANDARD FILM RES - 1/4W - 5% - 250ppm/°C	BC COMPONENTS
R3	2M4	SMD STANDARD FILM RES - 1/4W - 5% - 250ppm/°C	BC COMPONENTS
R30	10R	SMD STANDARD FILM RES - 1/8W - 5% - 250ppm/°C	BC COMPONENTS
R31	15K	SMD STANDARD FILM RES - 1/8W - 1% - 100ppm/°C	BC COMPONENTS
R32	47R	SMD STANDARD FILM RES - 1/4W - 5% - 250ppm/°C	BC COMPONENTS
R34	3K3	SMD STANDARD FILM RES - 1/4W - 5% - 250ppm/°C	BC COMPONENTS
R35	0R0	SMD STANDARD FILM RES - 1/8W - 5% - 250ppm/°C	BC COMPONENTS
R37	100K	SMD STANDARD FILM RES - 1/4W - 5% - 250ppm/°C	BC COMPONENTS
R38	56R	SMD STANDARD FILM RES - 1/8W - 5% - 250ppm/°C	BC COMPONENTS

Table 7. Bill of material (continued)

Res. Des.	Part Type/ Part Value	Description	Supplier
R39	130R	SMD STANDARD FILM RES - 1/4W - 5% - 250ppm/°C	BC COMPONENTS
R4	2M4	SMD STANDARD FILM RES - 1/4W - 5% - 250ppm/°C	BC COMPONENTS
R40	6R8	SFR25 AXIAL STAND. FILM RES - 0.4W - 5% - 250ppm/°C	BC COMPONENTS
R41	100R	SFR25 AXIAL STAND. FILM RES - 0.4W - 5% - 250ppm/°C	BC COMPONENTS
R42	5K6	SMD STANDARD FILM RES - 1/4W - 5% - 250ppm/°C	BC COMPONENTS
R43	51R	SMD STANDARD FILM RES - 1/8W - 5% - 250ppm/°C	BC COMPONENTS
R44	2K7	SMD STANDARD FILM RES - 1/4W - 5% - 250ppm/°C	BC COMPONENTS
R46	100K	SMD STANDARD FILM RES - 1/8W - 5% - 250ppm/°C	BC COMPONENTS
R47	1K0	SMD STANDARD FILM RES - 1/8W - 5% - 250ppm/°C	BC COMPONENTS
R48	47K	SMD STANDARD FILM RES - 1/8W - 5% - 250ppm/°C	BC COMPONENTS
R49	39K	SMD STANDARD FILM RES - 1/4W - 5% - 250ppm/°C	BC COMPONENTS
R50	6K2	SMD STANDARD FILM RES - 1/8W - 1% - 100ppm/°C	BC COMPONENTS
R51	120K	SMD STANDARD FILM RES - 1/8W - 1% - 100ppm/°C	BC COMPONENTS
R52	6K8	SMD STANDARD FILM RES - 1/4W - 5% - 250ppm/°C	BC COMPONENTS
R53	0R0	0R0 JUMPER	BC COMPONENTS
R54	0R0	0R0 JUMPER	BC COMPONENTS
R55	0R0	0R0 JUMPER	BC COMPONENTS
R56	1K8	SMD STANDARD FILM RES - 1/8W - 5% - 250ppm/°C	BC COMPONENTS
R57	0R0	0R0 JUMPER	BC COMPONENTS
R58	100K	SMD STANDARD FILM RES - 1/8W - 5% - 250ppm/°C	BC COMPONENTS
R59	100K	SMD STANDARD FILM RES - 1/8W - 5% - 250ppm/°C	BC COMPONENTS
R6	NTC_10R S236	NTC RESISTOR P/N B57236S0100M000	EPCOS
R60	10K	SMD STANDARD FILM RES - 1/4W - 5% - 250ppm/°C	BC COMPONENTS
R62	4K7	SMD STANDARD FILM RES - 1/8W - 5% - 250ppm/°C	BC COMPONENTS
R65	47K	SMD STANDARD FILM RES - 1/8W - 5% - 250ppm/°C	BC COMPONENTS
R66	2K2	SMD STANDARD FILM RES - 1/4W - 5% - 250ppm/°C	BC COMPONENTS
R69	4K7	SMD STANDARD FILM RES - 1/8W - 5% - 250ppm/°C	BC COMPONENTS
R7	1M0	MBB0207 AXIAL FILM RES - 0.4W - 1% - 50ppm/°C	BC COMPONENTS
R70	100K	SMD STANDARD FILM RES - 1/8W - 5% - 250ppm/°C	BC COMPONENTS
R71	12K	SMD STANDARD FILM RES - 1/4W - 1% - 100ppm/°C	BC COMPONENTS
R72	0R0	0R0 JUMPER	BC COMPONENTS
R8	1M0	MBB0207 AXIAL FILM RES - 0.4W - 1% - 50ppm/°C	BC COMPONENTS
R9	82K	SMD STANDARD FILM RES - 1/8W - 1% - 100ppm/°C	BC COMPONENTS

Table 7. Bill of material (continued)

Res. Des.	Part Type/ Part Value	Description	Supplier
R101 ^[1]	39R	SMD STANDARD FILM RES - 1/8W - 5% - 250ppm/°C	BC COMPONENTS
T1	86A-5166A	RESONANT POWER TRANSFORMER	DELTA ELECTRONICS
U1	L6563	TRANSITION-MODE PFC CONTROLLER	STMicroelectronics
U2	L6599D	HIGH VOLTAGE RESONANT CONTROLLER	STMicroelectronics
U3	SFH617A-2	OPTOCOUPLER	INFINEON
U4	TL431AIZ	PROGRAMMABLE SHUNT VOLTAGE REFERENCE	STMicroelectronics

Note: 1 R101 mounted by reworking on PCB

6 PFC coil specification

- Application type: Consumer, IT
- Transformer type: Open
- Coil former: vertical type, 6+6 pins
- Max. temp. rise: 45°C
- Max. operating ambient temp.: 60° C
- Mains insulation: N.A.

6.1 Electrical characteristics

- Converter topology: Boost, Transition mode
- Core type: RM14 - PC40 or equivalent
- Min. operating frequency: 20 kHz
- Primary inductance: 700 μ H \pm 10% @1kHz - 0.25V (see [Note 1](#))
- Peak primary current: 5 Apk
- RMS primary current: 1.8 A rms

Note: 1 Measured between pins #2 & #5

Figure 18. Electrical diagram

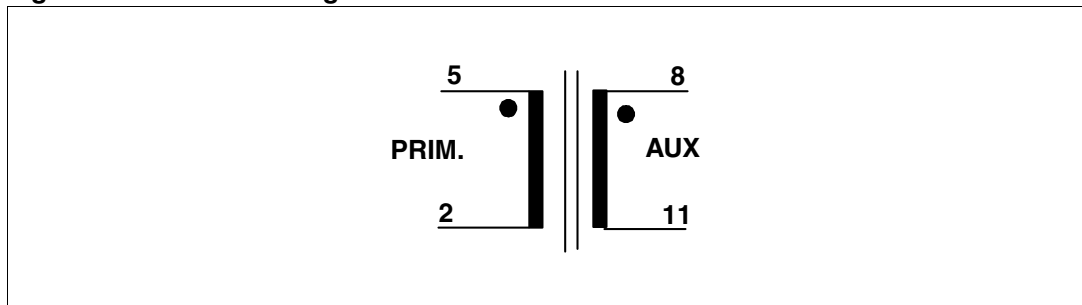

Table 8. Winding characteristics

Pins	Winding	RMS current	Number of turns	Wire type
5 - 2	PRIMARY	1.8 A _{RMS}	53	STRANDED 7 x ϕ 0.28 mm – G2
8 - 11	AUX ⁽¹⁾	0.05 A _{RMS}	4 SPACED	ϕ 0.28 mm – G2

1. Auxiliary winding is wound on top of primary winding

6.2 Mechanical aspect and pin numbering

- Maximum height from PCB: 22 mm
 - Coil former type: vertical, 6+6 pins
 - Pin distance: 5.08 mm
 - Pins #1, 3, 4, 6, 7, 10, 12 are removed - Pin 9 is for polarity key.
 - External copper shield: Bare, wound around the ferrite core and including the winding and coil former. Height is 7mm. Connected by a solid wire soldered to pin 11.
-
- Manufacturer: DELTA ELECTRONICS
 - P/N: 86A - 5158C

Figure 19. Bottom view

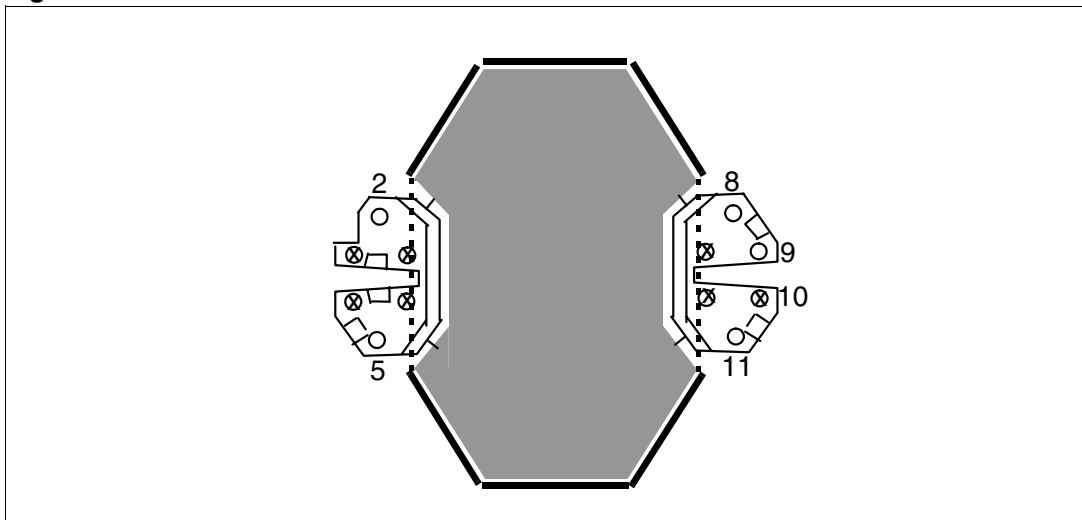

7 Resonant power transformer specification

- Application type: Consumer, IT
- Transformer type: Open
- Coil former: Horizontal type, 7+7 pins, 2 Slots
- Max. temp. rise: 45°C
- Max. operating ambient temp.: 60°C
- Mains insulation: Compliance with EN60950

7.1 Electrical characteristics

- Converter topology: half-bridge, resonant
- Core type: ER35 - PC40 or equivalent
- Min. operating frequency: 60 kHz
- Typical operating frequency: 100 kHz
- Primary inductance: 810 $\mu\text{H} \pm 10\%$ @ 1kHz - 0.25V (see [Note 1](#))
- Leakage inductance: 200 $\mu\text{H} \pm 10\%$ @ 1kHz - 0.25V (see [Note 1](#) and [Note 2](#))

Note: 1 Measured between pins 1-4.

2 Measured between pins 1-4 with ONLY a secondary winding shorted.

Figure 20. Electrical diagram

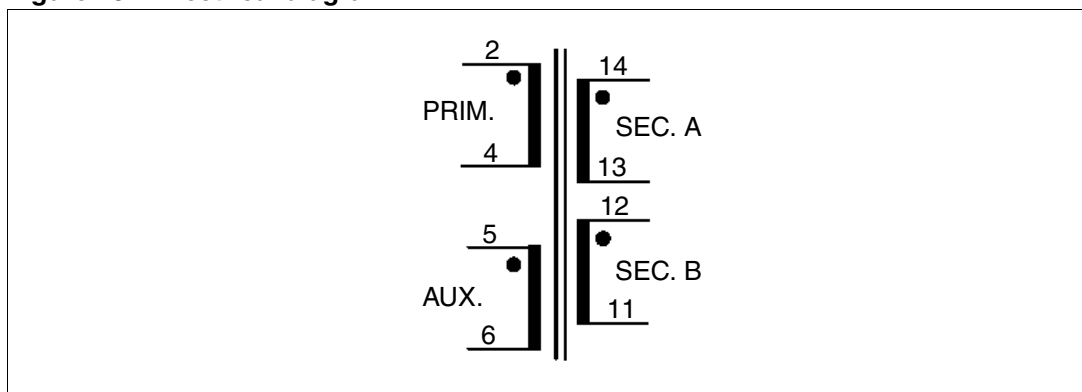

Table 9. Winding characteristics

Pins	Winding	RMS current	Number of turns	Wire type
2 - 4	PRIMARY	1 A _{RMS}	60	MULTISTRAND -0.12x12-G2
14 - 13	SEC. A ⁽¹⁾	4 A _{RMS}	6	MULTISTRAND -0.20x20-G2
12 - 11	SEC. B ⁽²⁾	4 A _{RMS}	6	MULTISTRAND -0.20x20-G2
5-6	AUX ⁽²⁾	0.05 A _{RMS}	5 SPACED	0.22-G2

1. Secondary windings A and B must be wound in parallel

2. Auxiliary winding is wound on top of primary winding

7.2 Mechanical aspect and Pin numbering

- Maximum height from PCB: 22 mm
 - Coil former type: horizontal, 7+7 Pins (Pins 1 and 7 are removed)
 - Pin distance: 5 mm
 - Row distance: 30 mm
-
- Manufacturer: DELTA ELECTRONICS
 - P/N: 86A-5166A

Figure 21. Pin lay-out, top view

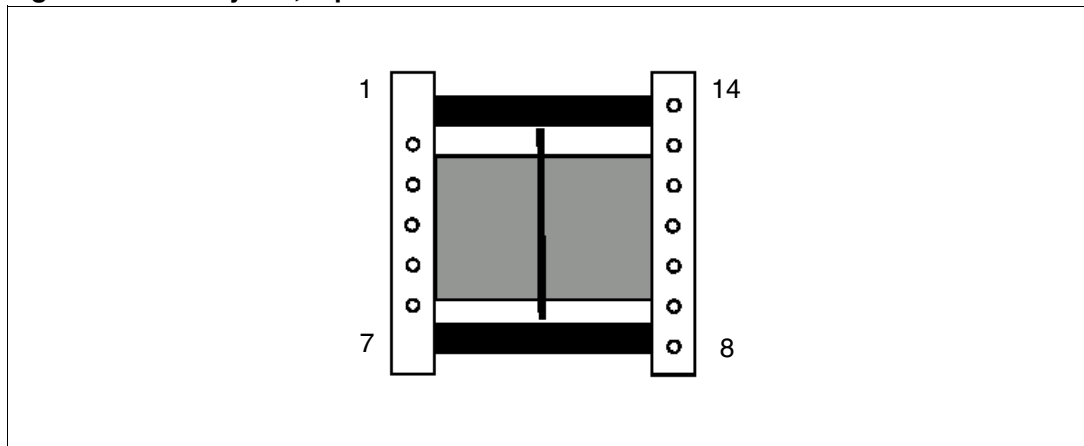

8 PCB lay-out

Figure 22. Thru-hole component placing and top silk screen

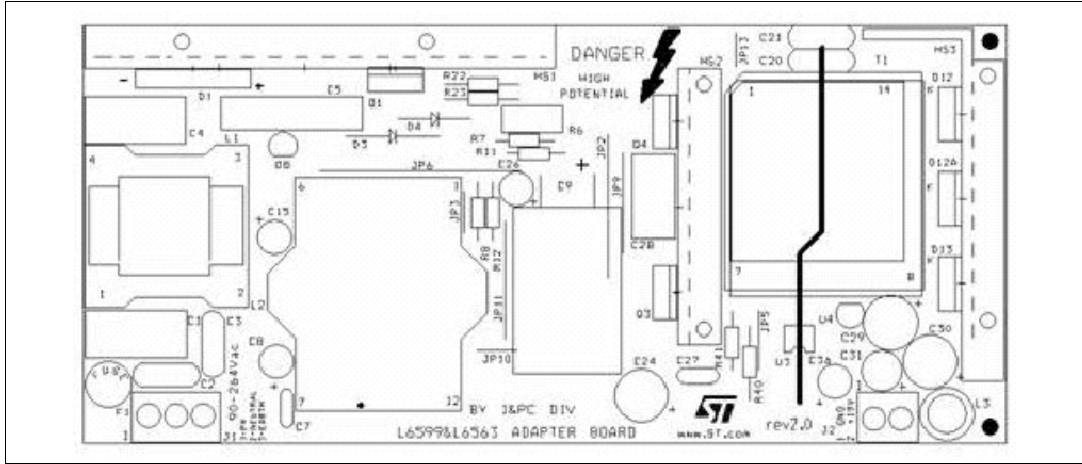

Figure 23. SMT component placing and bottom silk screen

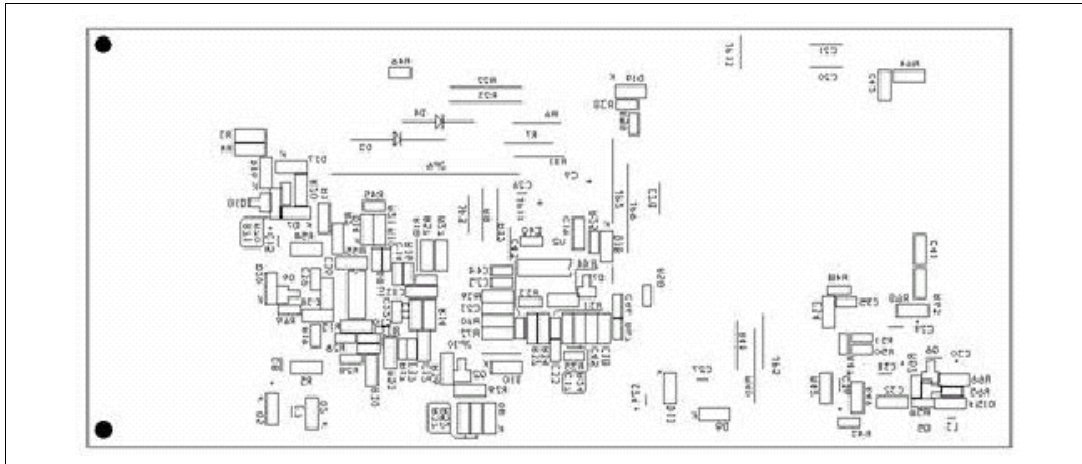
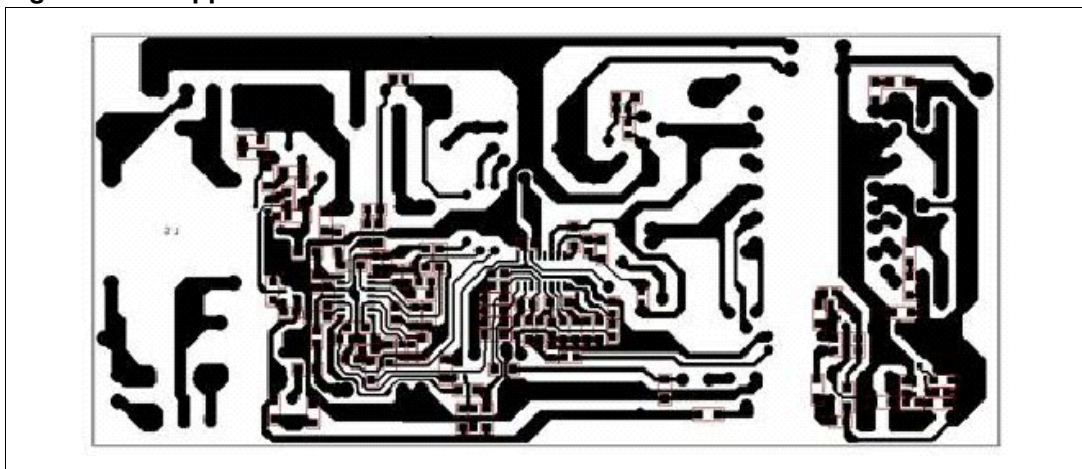

Figure 24. Copper tracks



9 Revision history

Table 10. Revision history

Date	Revision	Changes
01-Aug-2006	1	Initial release.

Please Read Carefully:

Information in this document is provided solely in connection with ST products. STMicroelectronics NV and its subsidiaries ("ST") reserve the right to make changes, corrections, modifications or improvements, to this document, and the products and services described herein at any time, without notice.

All ST products are sold pursuant to ST's terms and conditions of sale.

Purchasers are solely responsible for the choice, selection and use of the ST products and services described herein, and ST assumes no liability whatsoever relating to the choice, selection or use of the ST products and services described herein.

No license, express or implied, by estoppel or otherwise, to any intellectual property rights is granted under this document. If any part of this document refers to any third party products or services it shall not be deemed a license grant by ST for the use of such third party products or services, or any intellectual property contained therein or considered as a warranty covering the use in any manner whatsoever of such third party products or services or any intellectual property contained therein.

UNLESS OTHERWISE SET FORTH IN ST'S TERMS AND CONDITIONS OF SALE ST DISCLAIMS ANY EXPRESS OR IMPLIED WARRANTY WITH RESPECT TO THE USE AND/OR SALE OF ST PRODUCTS INCLUDING WITHOUT LIMITATION IMPLIED WARRANTIES OF MERCHANTABILITY, FITNESS FOR A PARTICULAR PURPOSE (AND THEIR EQUIVALENTS UNDER THE LAWS OF ANY JURISDICTION), OR INFRINGEMENT OF ANY PATENT, COPYRIGHT OR OTHER INTELLECTUAL PROPERTY RIGHT.

UNLESS EXPRESSLY APPROVED IN WRITING BY AN AUTHORIZED ST REPRESENTATIVE, ST PRODUCTS ARE NOT RECOMMENDED, AUTHORIZED OR WARRANTED FOR USE IN MILITARY, AIR CRAFT, SPACE, LIFE SAVING, OR LIFE SUSTAINING APPLICATIONS, NOR IN PRODUCTS OR SYSTEMS WHERE FAILURE OR MALFUNCTION MAY RESULT IN PERSONAL INJURY, DEATH, OR SEVERE PROPERTY OR ENVIRONMENTAL DAMAGE. ST PRODUCTS WHICH ARE NOT SPECIFIED AS "AUTOMOTIVE GRADE" MAY ONLY BE USED IN AUTOMOTIVE APPLICATIONS AT USER'S OWN RISK.

Resale of ST products with provisions different from the statements and/or technical features set forth in this document shall immediately void any warranty granted by ST for the ST product or service described herein and shall not create or extend in any manner whatsoever, any liability of ST.

ST and the ST logo are trademarks or registered trademarks of ST in various countries.

Information in this document supersedes and replaces all information previously supplied.

The ST logo is a registered trademark of STMicroelectronics. All other names are the property of their respective owners.

© 2006 STMicroelectronics - All rights reserved

STMicroelectronics group of companies

Australia - Belgium - Brazil - Canada - China - Czech Republic - Finland - France - Germany - Hong Kong - India - Israel - Italy - Japan - Malaysia - Malta - Morocco - Singapore - Spain - Sweden - Switzerland - United Kingdom - United States of America

www.st.com

