

CR6851 Demo Board 12V/3A 电路及元器件参数表

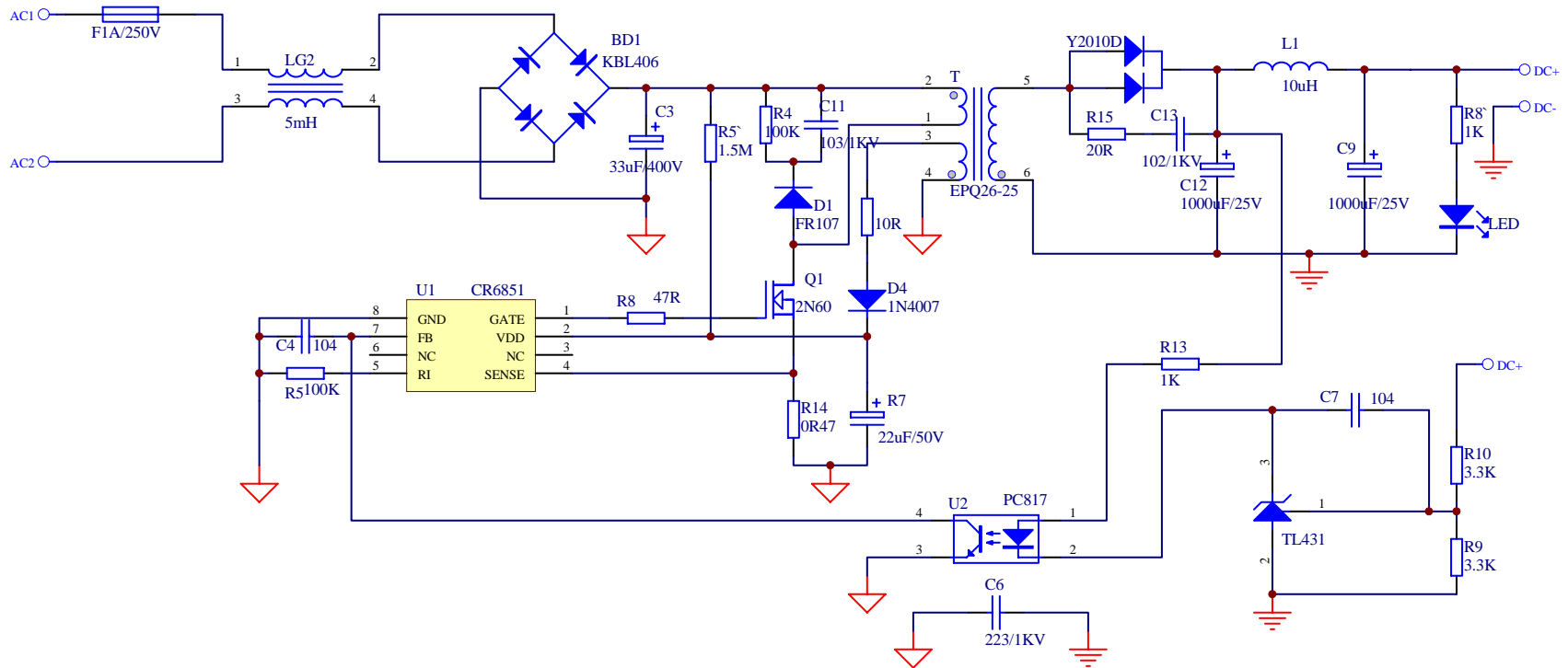

Quantity	Part Number	Description	Quantity	Part Number	Description
1	FUSE1	F1A/250V	1		10R
1	LG2	5mH	1	R15	20R
1	BD1	KBL406	2	R13、R8`	1K
1	C3	33uF/400V	2	R9、R10	3.3K
1	C11	103/1KV	1	Q1	2N60
2	C4、C7	104	1	D1	FR107
1	C13	102/1KV	1	D4	1N4007
1	C6	223/1KV	1		Y2010D
2	C9、C12	1000uF/25V	1		LED
1	R7	22uF	1	U1	CR6848
1	R5`	1.5M	1	U2	PC817B
2	R4、R5	100K	1		TL431
1	R8	47R			
1	R14	0R47			

变压器示意图及参数配置：

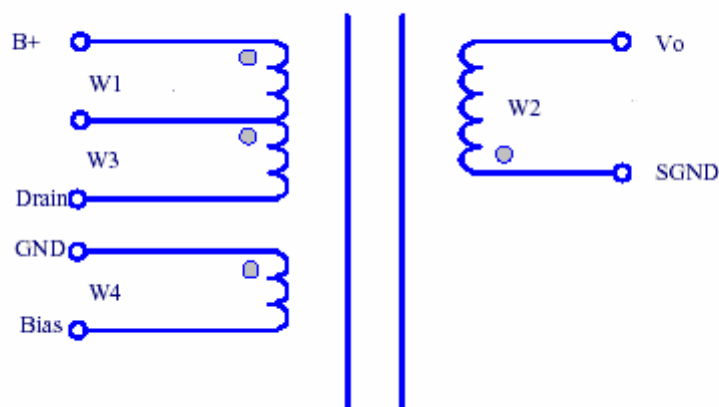

Core & Bobbin	Winding	Wire Gauge(mm)	Turns
PQ26-25	W1	0.37*1	26
	W2	0.8*1	8
	W3	0.37*1	26
	W4	0.2*1	9

NOTE: $N1(W1+W3)$ inductance=800uH