

<b>Title</b>	<b><i>Engineering Prototype Report for EP-86 – 6.6 W Multi-Class Powered Device (PD) for Power over Ethernet (PoE) Using DPA-Switch<sup>®</sup> (DPA423G)</i></b>
<b>Specification</b>	Input: 33-57 VDC, Output: 3.3 V / 2.0 A
<b>Application</b>	PoE Class 2 PD – Including IEEE802.3af Compliant Interface Circuit
<b>Author</b>	Power Integrations Applications Department
<b>Document Number</b>	EPR-86
<b>Date</b>	April 13, 2006
<b>Revision</b>	1.1

### Summary and Features

- Meets **IEEE802.3af** requirements according to University of New Hampshire Interoperability Consortium (**UNH-IOC**) test results, for Class 1–3 PoE PDs
- *DPA-Switch* PWM controller with integrated 220 V power MOSFET switch
  - Under-voltage (UV) and overvoltage (OV) shutdown functions
  - Auto-recovering, hysteretic thermal shutdown
  - Auto-restart function: protects against short-circuit and open loop faults
  - No-load regulation achieved by cycle skipping
  - Fully integrated soft-start minimizes start-up stress and overshoot
  - Externally programmed  $I_{LIMIT}$  scales with  $V_{IN}$  for power limiting
  - Lossless MOSFET current sense eliminates external sensing components
- Small footprint 3.1" × 1", low overall height 0.45" (excluding RJ-45 connector)

The products and applications illustrated herein (including circuits external to the products and transformer construction) may be covered by one or more U.S. and foreign patents or potentially by pending U.S. and foreign patent applications assigned to Power Integrations. A complete list of Power Integrations' patents may be found at [www.powerint.com](http://www.powerint.com).

## Table Of Contents

1	Introduction.....	3
2	Power Supply Specification .....	4
3	Schematic.....	5
4	Circuit Operation.....	6
4.1	General .....	6
4.2	<i>DPA-Switch</i> Primary.....	6
4.3	Output Rectification.....	6
4.4	Output Feedback.....	6
4.5	PoE Interface Circuit Description.....	7
4.6	Wide Hysteresis Under-Voltage Lockout.....	8
5	Bill of Materials .....	10
6	Layout.....	12
7	Transformer Design Spreadsheet.....	13
8	Transformer Specification.....	15
8.1	Transformer Winding .....	15
8.2	Electrical Specifications.....	15
8.3	Materials.....	15
8.4	Transformer Build Diagram .....	16
8.5	Transformer Construction.....	16
9	Performance Data .....	17
9.1	Efficiency.....	17
9.2	Load Regulation .....	18
9.3	Line Regulation .....	18
9.4	Overload Output Current.....	19
10	Waveforms.....	20
10.1	Drain Voltage and Current, Full-Load Operation .....	20
10.2	Output Voltage Start-Up Profile.....	20
10.3	Load Transient Response (75% to 100% Load Step) .....	21
10.4	Output Ripple Measurements.....	22
10.4.1	Ripple Measurement Technique .....	22
10.4.2	Output Ripple Measurements.....	23
11	Revision History .....	24

### Important Note:

Although this board was designed to satisfy safety isolation requirements, it has not been agency approved. Therefore, please take the appropriate safety precautions.



## 1 Introduction

This engineering report describes a PoE power supply designed around the DPA423G. The supply can deliver 6.6 W continuously, from an input voltage range of 33 VDC to 57 VDC.

The following design information is provided: the power supply specification, circuit diagrams, a complete bill of materials, the results of the *PIXIs* spreadsheet file that was used to design the supply and detailed information on the design and construction of the transformer. Data and test results that document the performance of the supply under various line and load conditions are also included.



Figure 1 – Populated Circuit Board Top View.

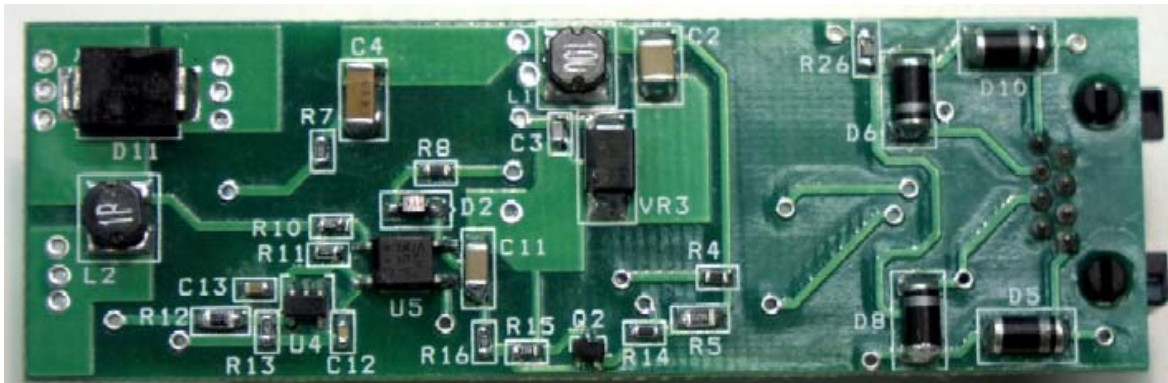


Figure 2 – Populated Circuit Board Bottom View.

## 2 Power Supply Specification

Description	Symbol	Min	Typ	Max	Units	Comment
<b>Input</b>						
Voltage	$V_{IN}$	33	48	57	VDC	
Under-Voltage ON	$V_{IN\_UV\_ON}$			42	VDC	
Under-Voltage OFF	$V_{IN\_UV\_OFF}$	33			VDC	
<b>Output</b>						
Output Voltage 1	$V_{OUT1}$	3.135	3.3	3.465	V	± 5% 20 MHz bandwidth
Output Ripple Voltage 1	$V_{RIPPLE1}$			35	mVp-p	
Output Current 1	$I_{OUT1}$	0		2	A	
Output Peak Current 1	$I_{OUT1\_PK}$	2.5			A	
<b>Total Output Power</b>						
Average Output Power	$P_{OUT1}$		6.6		W	R6 = 10.2 $\Omega$
Average Output Power	$P_{OUT\_FAULT}$	8.6			W	
<b>Full Load Efficiency</b>	$\eta$		73		%	
<b>Environmental</b>						
Conducted EMI		Meets CISPR22B / EN55022B				
Safety		Designed to meet IEC950, UL1950 Class II				
Ambient Temperature	$T_{AMB}$	0		40	$^{\circ}\text{C}$	





## 4 Circuit Operation

### 4.1 General

A flyback topology was used to minimize circuit board size, parts count and cost. This topology also provides excellent operating efficiency across the input voltage range.

### 4.2 DPA-Switch Primary

The DPA423G IC implements PWM control of the internal power MOSFET and initiates a soft start-up function when it first powers up. The IC also monitors die temperature as part of its over-temperature protection function and also monitors the input voltage as part of its under-voltage detection and overvoltage shutdown functions. The integrated 220 V MOSFET provides excellent switching characteristics at the selected 400 kHz operating frequency. The MOSFET and controller consume very little power, giving good efficiency across the entire input voltage operating range.

Diodes D3 through D9 ensure that the incoming DC input voltage is correctly polarized. Capacitors C1 and C2 and inductor L1 form a low-cost pi ( $\pi$ ) filter that attenuates conducted EMI noise, to keep it from being passed to the incoming line.

Resistors R4 and R6 program the internal current limit of the DPA423G, so that it reduces as the input voltage increases. This helps to keep the variance of the maximum output overload current below 5%, across the entire input voltage range.

The IC's integrated MOSFET is protected from overvoltage stresses that could damage it (during a line surge) by a primary-side Zener diode clamp (VR3). Zener diode VR3 does not conduct under normal operating conditions.

The primary bias winding provides CONTROL pin current after start-up. Diode D2 rectifies the bias winding voltage, while R8 and C11 attenuate high frequency switching noise and reduce the peak charging of the bias voltage.

### 4.3 Output Rectification

The secondary winding voltage is rectified by a low-loss Schottky diode (D11). Low ESR, tantalum output capacitors, C7 and C8, filter the output voltage. The LC output filter (L2, C9 and C10) further attenuates switching noise and ripple from the output voltage.

### 4.4 Output Feedback

Resistor divider (R12 and R13) senses the output voltage and feeds it into the reference pin of a 1.24 V reference IC (U4). The conduction of U4 pulls current through the LED of optocoupler U5, which controls the conduction of its phototransistor (U5-B). The phototransistor modulates the current that flows into the CONTROL pin of U1. Since the *DPA-Switch* is a current-to-duty-cycle converter, it uses the varying CONTROL pin current to pulse-width modulate the duty cycle of the MOSFET switch. Resistor R10 sets the gain of U4, while R11 and C13 compensate for the variation in gain of U4 over the frequency range of the feedback loop's bandwidth (about 10 kHz). Feedback



compensation is required to ensure stable operation of the supply and optimum response to line and load transients. Capacitor C12 performs a soft-finish function that prevents the output voltage from overshooting the regulation set point during initial startup of the converter.

#### 4.5 PoE Interface Circuit Description

See DI-88 for a full description. Resistor R26 provides the correct impedance for the detection phase of PD operation.

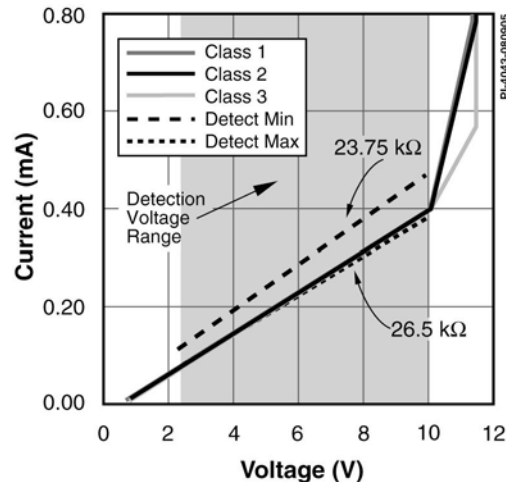


Figure 4 – Detection Impedance V-I curve.

The classification circuit is enabled when Zener diode VR6 conducts (above 11 VDC). Transistor Q9 controls the bias current source programmed to approximately 350  $\mu$ A by resistor R21. This bias current source provides the minimum operating current to voltage reference IC U6. The main classification current flowing through R20 generates a voltage that is referenced to the internal reference (1.24 VDC) of U6 and that later closes the loop by controlling the base drive of Q7. The value of the classification current source is determined by the value of the voltage on the reference pin of U6 divided by the value of R20 in ohms.



Class	P <sub>OUT</sub> (min)	P <sub>OUT</sub> (max)	I <sub>CL</sub> (min)	I <sub>CL</sub> (max)	R34
	W	W	mA	mA	Ohms
0	0.44	12.95	0.5	4	-
1	0.44	3.84	9	12	133
2	3.84	6.49	17	20	69.8
3	6.49	12.95	26	30	45.3

Figure 5 – Table of PoE Classifications and Power Levels.

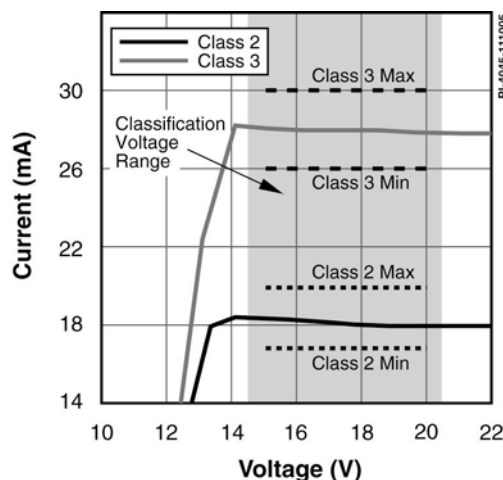


Figure 6 – Classification Current (Class 2: R34 = 69.8 Ω; Class 3: R34 = 45.3 Ω).

Zener diode VR5 conducts above 27 VDC, raising the gate voltage on the pass-switch MOSFET (Q8), turning it on when the gate-threshold voltage is exceeded. Pull-down resistor R25 limits the current through VR5 while pull-down resistor R24 keeps Q8 turned off, unless it is being actively driven on. Zener diode VR4 limits the maximum gate-to-source voltage on Q8 to 15 V. When VR5 conducts, it also turns on Q6 through R23. Transistor Q6 pulls down on the base of Q7, which turns off the main classification current source (although the bias current source of 350 μA will continue to conduct).

#### 4.6 Wide Hysteresis Under-Voltage Lockout

If there were no other components connected to the L pin, then resistor R5 would set the under-voltage turn-on threshold to approximately 35 VDC and the turn-off threshold to approximately 33 VDC.

However, in the case of PoE, the turn-on voltage is much higher than the turn-off voltage. This requires more under-voltage hysteresis. When the power supply is operating normally, the bias voltage is approximately 14 VDC. Resistors R15 and R16 form a voltage divider that turns off the base of Q2, once the DC-DC converter has begun switching and the bias voltage is present. At start-up, when the bias voltage is absent,





Q2 is on, and sinks additional current from the resistor (R5) that connects the L pin to the DC input voltage. The value of R14 was selected so that an extra 10  $\mu\text{A}$  is drawn at startup, which increases the turn-on threshold voltage to 41 VDC typical. However, because Q2 turns off after start-up, the UV turn-off threshold stays at 34 VDC (see DI-101 for more details).

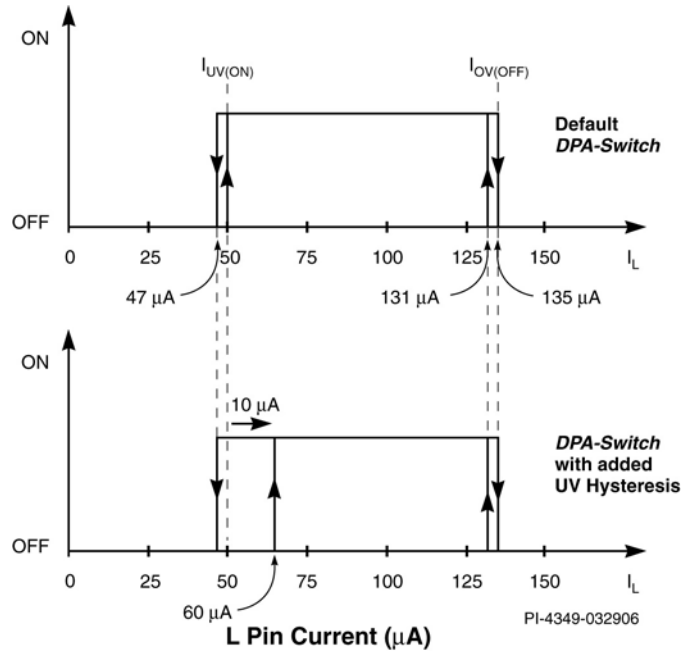


Figure 7 – L-pin current without and with the widened UV hysteresis circuit.



## 5 Bill of Materials

Item	Qty.	Ref.	Description	Mfg Part Number	Mfg
1	2	C1, C2	470 nF, 100 V, Ceramic, X7R, 1210	ECJ-4YB2A474K	Panasonic
2	1	C3	47 pF, 100 V, Ceramic, NPO, 0603	06031A470JAT2A	AVX
3	1	C4	1000 pF, 1500V, 1808	1808SC102KAT1A	AVX
4	2	C5, C13	100 nF 25 V, Ceramic, X7R, 0603	ECJ-1VB1E104K	Panasonic
5	1	C6	22 $\mu$ F, 10 V, Tant Electrolytic, SMD	TAJA226K010R	Kemet
6	3	C7, C8, C9	330 $\mu$ F, 6.3 V, Tant Electrolytic, SMD	T495X337K006AS	Kemet
7	1	C10	1 $\mu$ F, 16 V, Ceramic, X5R, 0603	GRM188R61C105KA 93D	Murata
8	1	C11	1 $\mu$ F, 25 V, Ceramic, X7R, 1206	ECJ-3YB1E105K	Panasonic
9	1	C12	220 nF, 25 V, Ceramic, X7R, 0603	06033D224KAT2A	AVX
10	1	D2	75 V, 0.2 A, Fast Switching, 50 ns, SOD-323	1N4148WS-7	Diode Inc.
11	8	D3, D4, D5, D6, D7, D8, D9, D10	100 V, 1 A, Rectifier, Glass Passivated, DO-213AA (MELF)	DL4002	Diodes Inc
12	1	D11	20 V, 4 A, Schottky, SMD, DO-214AB	SL42-9B	Vishay
13	1	J1	R/A, RJ45 Non-shielded, PCBM	RJHS-5080	Amphenol Canada
14	2	J2-1, J2-2	Zierick output pins		Zierick
15	1	L1	10 $\mu$ H, 0.85 A	HM79-10100LFTR7	B.I.Technologies
16	1	L2	1 $\mu$ H, 1.9 A	HM79-101R0LFTR7	B.I.Technologies
17	1	Q2	PNP, Small Signal BJT, 40 V, 0.2 A, SOT-323	MMST3906-7	Diodes Inc
18	3	Q4, Q5, Q7	NPN, Small Signal BJT, 80 V, 0.5 A, SOT-23	MMBTA06LT1	On Semiconductor
19	1	Q6	NPN, Small Signal BJT, 40 V, 0.2 A, SOT-323	MMST3904	Diodes Inc
20	1	Q8	100 V, 1.15 A, 250 m $\Omega$ , N-Channel, SOT-23	SI2328DS	Vishay
21	1	R4	1.00 M $\Omega$ , 1%, 1/16 W, Metal Film, 0603	ERJ-3EKF1004V	Panasonic
22	1	R5	649 k $\Omega$ , 1%, 1/8 W, Metal Film, 0805	ERJ-6ENF6493V	Panasonic
23	1	R6	10.00 k $\Omega$ , 1%, 1/16 W, Metal Film, 0603	ERJ-3EKF1002V	Panasonic
24	1	R7	10 $\Omega$ , 5%, 1/10 W, Metal Film, 0603	ERJ-3GEYJ100V	Panasonic
25	1	R8	100 $\Omega$ , 1%, 1/16 W, Metal Film, 0603	ERJ-3EKF1000V	Panasonic
26	1	R9	5.1 $\Omega$ , 5%, 1/10 W, Metal Film, 0603	ERJ-3GEYJ5R1V	Panasonic
27	1	R10	75 $\Omega$ , 5%, 1/10 W, Metal Film, 0603	ERJ-3GEYJ750V	Panasonic
28	1	R11	1 k $\Omega$ , 5%, 1/10 W, Metal Film, 0603	ERJ-3GEYJ102V	Panasonic
29	1	R12	33.2 k $\Omega$ , 1%, 1/8 W, Metal Film, 0805	ERJ-6ENF3322V	Panasonic



30	1	R13	20 k $\Omega$ , 5%, 1/10 W, Metal Film, 0603	ERJ-3GEYJ203V	Panasonic
31	1	R14	174 k $\Omega$ , 1%, 1/16 W, Metal Film, 0603	ERJ-3EKF1743V	Panasonic
32	1	R15, R16	10 k $\Omega$ , 5%, 1/10 W, Metal Film, 0603	ERJ-3GEYJ103V	Panasonic
35	1	R20	69.8 $\Omega$ , 1%, 1/16 W, Metal Film, 0603	ERJ-3EKF69R8V	Panasonic
36	1	R21	2 k $\Omega$ , 5%, 1/10 W, Metal Film, 0603	ERJ-3GEYJ202V	Panasonic
37	2	R22, R23	100 k $\Omega$ , 5%, 1/10 W, Metal Film, 0603	ERJ-3GEYJ104V	Panasonic
38	1	R24	220 k $\Omega$ , 5%, 1/10 W, Metal Film, 0603	ERJ-3GEYJ224V	Panasonic
39	1	R25	51 k $\Omega$ , 5%, 1/10 W, Metal Film, 0603	ERJ-3GEYJ513V	Panasonic
40	1	R26	24.9 k $\Omega$ , 1%, 1/8 W, Metal Film, 0805	ERJ-6ENF2492V	Panasonic
41	1	T1	Bobbin, ER14.5/6, Horizontal, 10 pins, SMD	HM00-A5861LF DA2062-ALD SIL6029 LSTA30825 SNX1393 YC-1404S	B.I Technologies Coilcraft Hical LiShin Santronics Ying Chin
42	1	U1	<i>DPA-Switch</i> , DPA423G, SMD-8	DPA423G	Power Integrations
43	1	U4	1.24 V Shunt Regulator IC, 1%, -40 to 85 °C, SOT23-5	LMV431AIM5	National Semiconductor
44	1	U5	Optocoupler, 80 V, CTR 200-400%, 4-Mini Flat	PC357N3T	Sharp
45	1	U6	1.24 V Shunt Regulator IC, 1%, -40 to 85 °C, SOT23-5	LMV431AIM5	National Semiconductor
46	1	VR3	150 V, 5 W, 5%, DO214AC (SMB)	SMBJ150A	Diodes, Inc
47	1	VR4	15.0 V, 5%, 150 mW, SOD-323	BZT52C15T-7	Diodes, Inc
48	1	VR5	27.0 V, 5%, 150 mW, SOD-323	MAZS2700ML	Panasonic-SSG
49	1	VR6	11 V, 5%, 500 mW, DO-213AA (MELF)	ZMM5241B-7	Diodes Inc
50	1	-	PCB, EP-86, REV B		



## 6 Layout

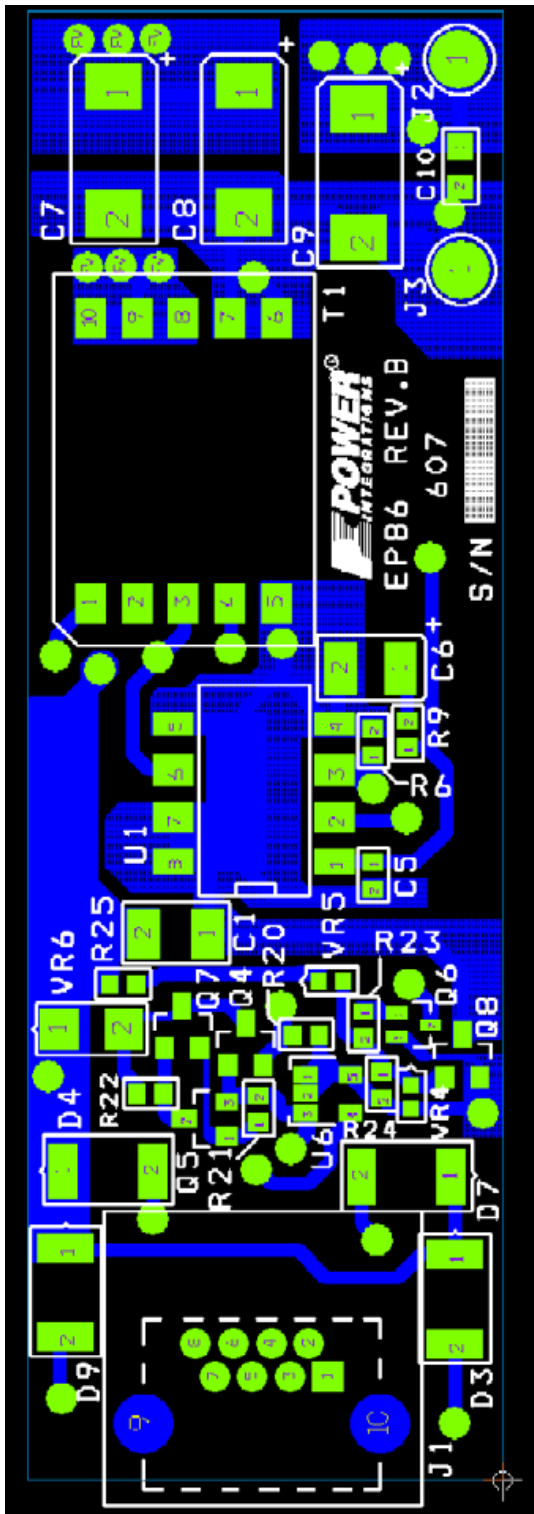


Figure 8 – PCB Layout Top Side.

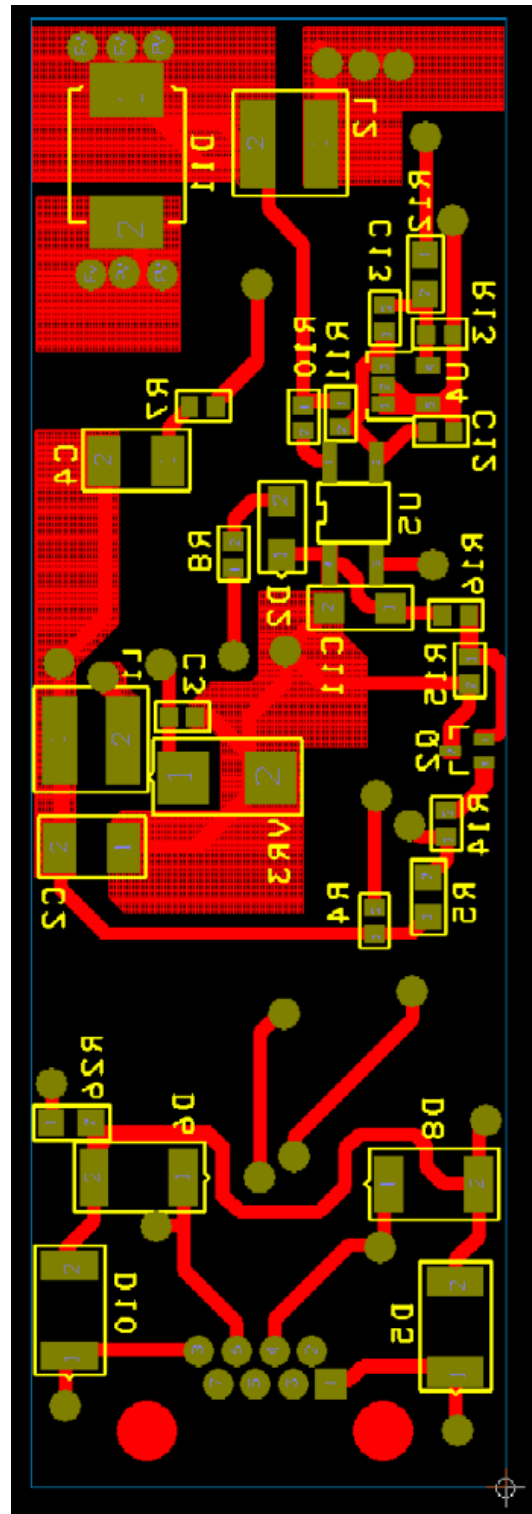


Figure 9 – PCB Layout Bottom Side.



## 7 Transformer Design Spreadsheet

DCDC_DPASwitch_Flyback_071405; Rev.2.7; Copyright Power Integrations 2005	INPUT	INFO	OUTPUT	UNITS	DPASwitch_Flyback_071405 - Continuous/Discontinuous mode Spreadsheet. Copyright 2005 Power Integrations
<b>ENTER APPLICATION VARIABLES</b>					<b>DC-DC Converter</b>
VDCMIN	36			Volts	Minimum DC Input Voltage
VDCMAX	57			Volts	Maximum DC Input Voltage
VO	3.3			Volts	Output Voltage (main)
PO	6.6	<i>Comment</i>		Watts	Verify temperature rise for continuous power. P and G packages may be thermally limited
n	0.8				Efficiency Estimate
Z			0.7		Loss Allocation Factor, (0.7 Recommended)
VB	14			Volts	Bias Voltage (Recommended between 12V and 18V)
<b>UV AND OV PARAMETERS</b>					
		min	max		
VUVOFF		30.0	33.1	Volts	Minimum undervoltage On-Off threshold
VUVON		32.2	34.7	Volts	Maximum undervoltage Off-On threshold (turn-on)
VOVON		74.9	-	Volts	Minimum overvoltage Off-On threshold
VOVOFF			94.7	Volts	Maximum overvoltage On-Off threshold (turn-off)
RL			619.0	k-Ohms	
<b>ENTER DPASWITCH VARIABLES</b>					
<b>DPASWITCH</b>	<b>DPA423G</b>			16VDC	36 VDC
<i>Chosen Device</i>	<i>DPA423G</i>		<i>Power Out</i>	6W	13W
ILIMITMAX	1.16	1.34		Amps	From DPASWITCH Data Sheet
<b>Frequency</b>	<b>F</b>				Enter 'F' for fS = 400KHz and 'L' for fS = 300KHz
fS	375000			Hertz	DPASWITCH Switching Frequency
VOR	38		38	Volts	Reflected Output Voltage
KI	0.7		0.7		Current Limit Reduction Factor
ILIMITEXT			0.812	Amps	Minimum External Current limit
RX			11.0	k-Ohms	Resistor from X pin to source to set external current limit
VDS	1			Volts	DPASWITCH on-state Drain to Source Voltage
VD	0.5			Volts	Output Winding Diode Forward Voltage Drop
VDB	0.7			Volts	Bias Winding Diode Forward Voltage Drop
KRP/KDP	0.62				Ripple to Peak Current Ratio (0.2 < KRP < 1.0 : 1.0 < KDP < 6.0)
<b>ENTER TRANSFORMER CORE/CONSTRUCTION VARIABLES</b>					
<b>Core Type</b>	<b>ER14.5</b>				
<b>Core Manuf</b>					
<b>Bobbin Manuf</b>					
<i>Core</i>		ER14.5		P/N:	ER14.5-3F3-S
<i>Bobbin</i>		ER14.5_Bobbin		P/N:	CPVS-ER14.5-1S-10P
AE			0.176	cm^2	Core Effective Cross Sectional Area
LE			1.9	cm	Core Effective Path Length
AL			1400	nH/T^2	Ungapped Core Effective Inductance
BW			1.9	mm	Bobbin Physical Winding Width
M	0			mm	Safety Margin Width (Half the Primary to Secondary Creepage Distance)
L	2				Number of Primary Layers
NS	2				Number of Secondary Turns



CURRENT WAVEFORM SHAPE PARAMETERS				
DMAX			0.52	Maximum Duty Cycle
Iavg			0.23 Amps	Average Primary Current
IP			0.64 Amps	Peak Primary Current
IR			0.40 Amps	Primary Ripple Current
IRMS			0.33 Amps	Primary RMS Current
<b>TRANSFORMER PRIMARY DESIGN PARAMETERS</b>				
LP			119 uHenries	Primary Inductance
NP			20	Primary Winding Number of Turns
NB			8	Bias Winding Number of Turns
ALG			297 nH/T^2	Gapped Core Effective Inductance
BP			2739 Gauss	Peak Flux density during transients (Limit to 3000 Gauss)
BM			2152 Gauss	Maximum Flux Density
BAC			667 Gauss	AC Flux Density for Core Loss Curves (0.5 X Peak to Peak)
ur			1203	Relative Permeability of Ungapped Core
LG			0.06 mm	Gap Length (Lg >> 0.051 mm)
BWE			3.8 mm	Effective Bobbin Width
<b>TRANSFORMER SECONDARY DESIGN PARAMETERS</b>				
ISP			6.38 Amps	Peak Secondary Current
ISRMS			3.15 Amps	Secondary RMS Current
IO			2.00 Amps	Power Supply Output Current
IRIPPLE			2.43 Amps	Output Capacitor RMS Ripple Current
<b>VOLTAGE STRESS PARAMETERS</b>				
VDRAIN			157 Volts	Maximum Drain Voltage (Includes Effect of Leakage Inductance)
PIVS			9 Volts	Output Rectifier Maximum Peak Inverse Voltage
PIVB			36 Volts	Bias Rectifier Maximum Peak Inverse Voltage
<b>ADDITIONAL OUTPUTS</b>				
V_OUT2			Volts	2nd Output Voltage
VD_OUT2			Volts	2nd Output - Diode Forward voltage
N_OUT2			0.00	2nd Output - Turns
PIV_OUT2			0 Volts	2nd Output - Diode Peak Inverse Voltage
V_OUT3			Volts	3rd Output Voltage
VD_OUT3			Volts	3rd Output - Diode Forward voltage
N_OUT3			0.00	3rd Output - Turns
PIV_OUT3			0 Volts	3rd Output - Diode Peak Inverse Voltage
I_OUT2			Amps	2nd Output - Output Current
I_OUT3			Amps	3rd Output - Output Current
Negative Output			N/A	If negative output exists enter Output number; eg: If VO2 is negative output, enter 2



## 8 Transformer Specification

### 8.1 Transformer Winding

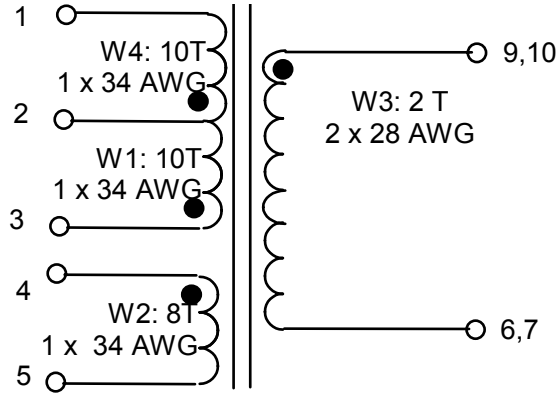


Figure 10 – Transformer Electrical Diagram.

### 8.2 Electrical Specifications

<b>Electrical Strength</b>	1 second, 60 Hz, from Pins 1-5 to Pins 6-10	1500 VDC
<b>Primary Inductance</b>	Pins 1-3, all other windings open	120 $\mu$ H, $\pm$ 10%
<b>Resonant Frequency</b>	Pins 1-3, all other windings open	7.5 MHz (Min.)
<b>Primary Leakage Inductance</b>	Pins 1-3, with Pins 6/7-9/10 shorted	3.0 $\mu$ H (Max.)

### 8.3 Materials

Item	Description
[1]	Core: ER14.5, Ferroxcube 3C96, 3F3 (or equivalent), $A_{LG} = 312 \text{ nH/T}^2$
[2]	Bobbin: ER14.5, 10 pin
[3]	Magnet Wire: #34 AWG, Double Coated (Heavy Nyleze)
[4]	Magnet Wire: #28 AWG, Double Coated (Heavy Nyleze)
[5]	Tape: 3M 1298 Polyester Film (or equivalent), 1.8 mm wide
[6] (optional)	Core Clamp ER14.5 Ferroxcube CLM14.5
[7]	Varnish (DIPPED ONLY, NOT VACUUM IMPREGNATED)



### 8.4 Transformer Build Diagram

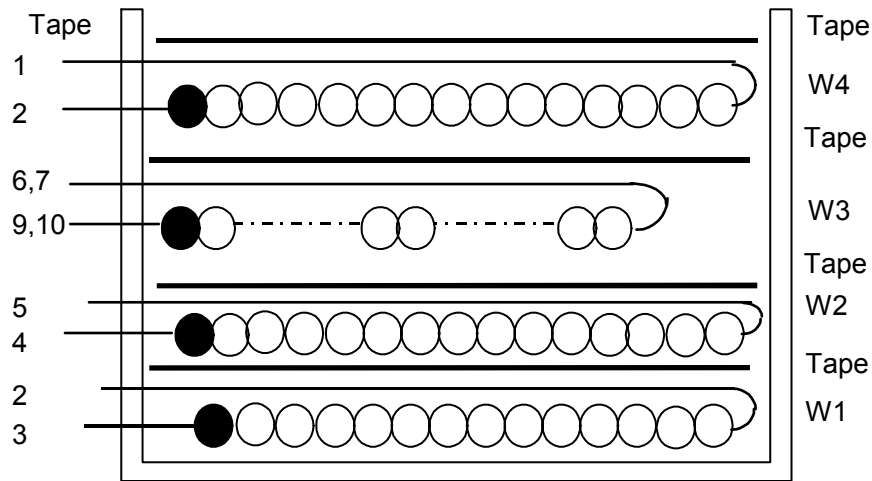


Figure 11 – Transformer Build Diagram.

### 8.5 Transformer Construction

Bobbin Preparation	Arrange bobbin & rotation such that primary start/finish wires do not overlap.
W1	Start at Pin 3. Wind 10 turns of item [3] in 1 layer. Bring finish lead back and terminate on Pin 2.
W2	Starting at Pin 4, wind 8 turns of item [3]. Spread turns evenly across bobbin in a single layer. Bring finish lead back and terminate on Pin 5.
Tape	Use one layer of item [5] for basic insulation.
W3	Start at Pins 9 and 10. Wind 2 turns of bifilar item [4] in 1 layer. Bring finish lead back and terminate on Pins 6 and 7.
Tape	Use one layer of item [5] for basic insulation.
W4	Continue from Pin 2. Wind 10 turns of item [3] in 1 layer. Bring finish lead back and terminate on Pin 1.
Outer Wrap	Use one layer of item [5] for basic insulation.
Final Assembly	Assemble and secure (glue or clamp, item [6]) core halves. Dip varnish item [7] and cure.





## 9 Performance Data

All measurements were taken at room temperature utilizing a DC input source and DC dynamic loads (except where resistive loads are specified). Input and output voltages and current were measured with dedicated digital multi-meters (DMMs).

### 9.1 Efficiency

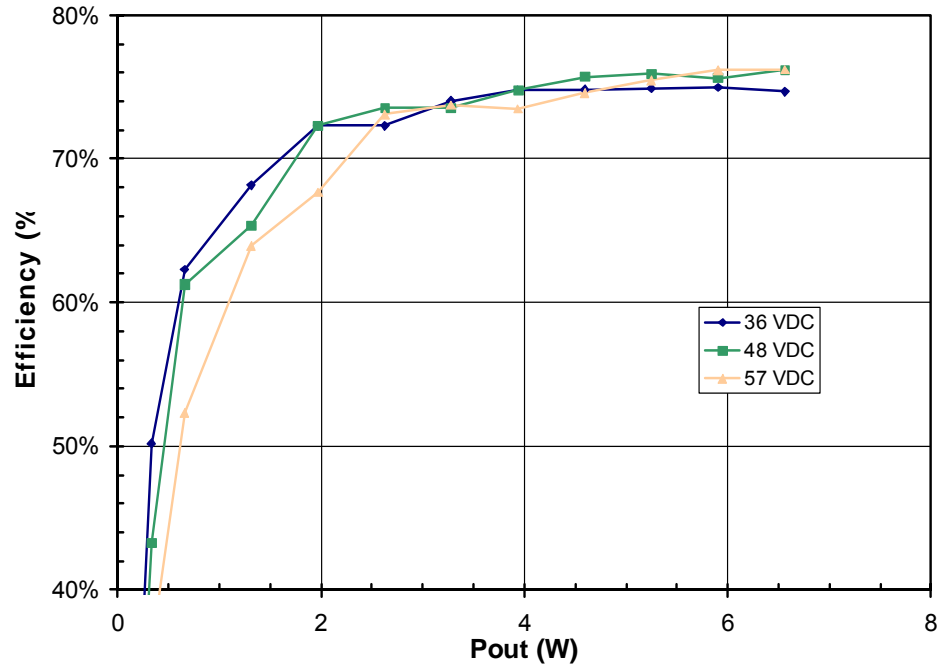


Figure 12 – Efficiency vs. Line and Load, Room Temperature.



### 9.2 Load Regulation

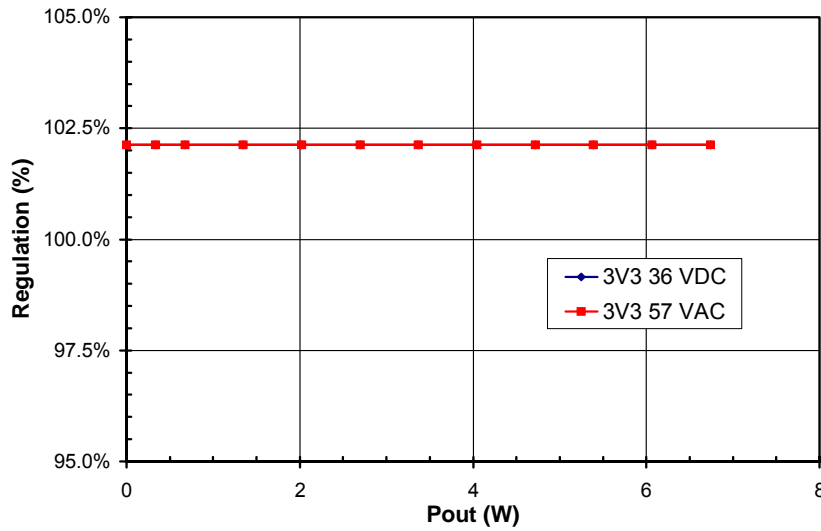


Figure 13 – Load Regulation, Room Temperature.

### 9.3 Line Regulation

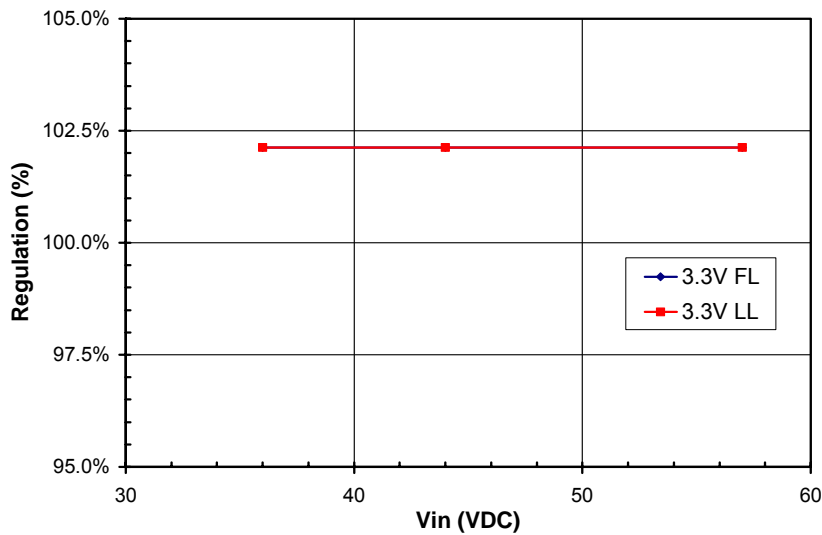
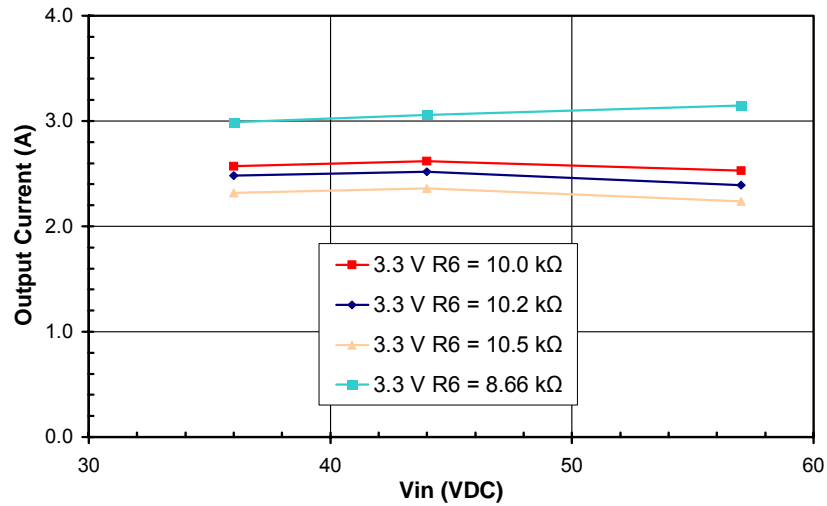


Figure 14 – Line Regulation, Room Temperature.



#### 9.4 Overload Output Current

The DC output load current was recorded just prior to the auto-restart operation at various input line voltages. Performance was measured for various values of resistor R6.

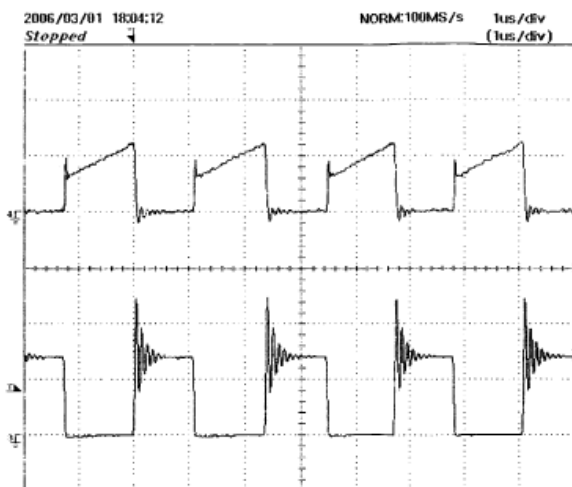


**Figure 15** – Overload Output Current vs. Line Voltage for Different Values of R6, Room Temperature.

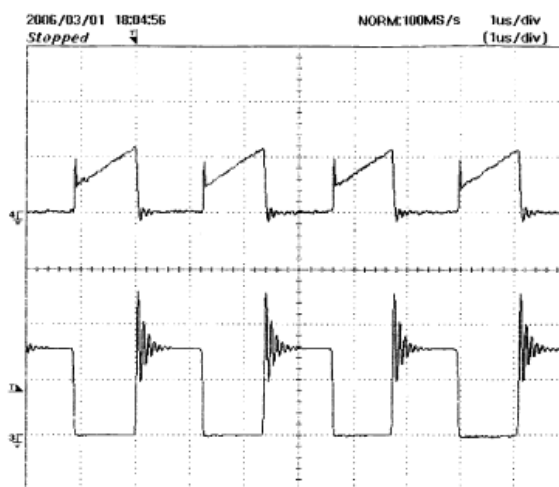


## 10 Waveforms

### 10.1 Drain Voltage and Current, Full-Load Operation

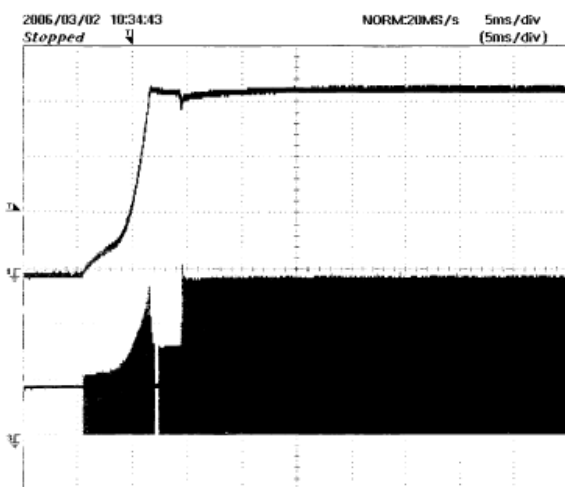


**Figure 16** – 36 VDC, Full Load.  
Upper:  $I_{DRAIN}$ , 0.5 A / div.  
Lower:  $V_{DRAIN}$ , 50 V, 1  $\mu$ s / div.

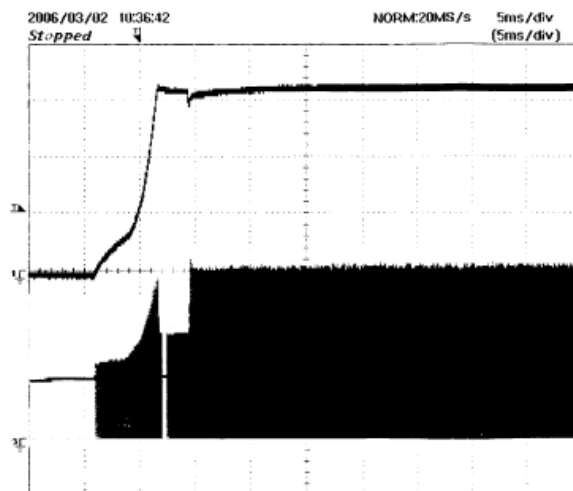


**Figure 17** – 57 VDC, Full Load.  
Upper:  $I_{DRAIN}$ , 0.5 A / div.  
Lower:  $V_{DRAIN}$ , 50 V, 1  $\mu$ s / div.

### 10.2 Output Voltage Start-Up Profile



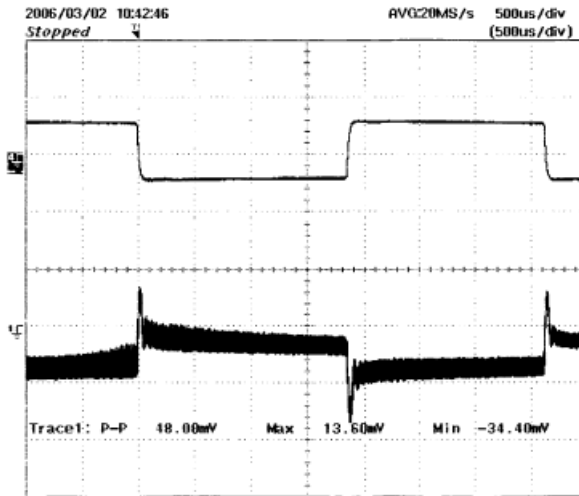
**Figure 18** – Start-Up Profile, 36 VDC, No Load (worst-case).  
Upper:  $V_{OUT}$ , 1 V / div.  
Lower:  $V_{DRAIN}$ , 50 V, 1  $\mu$ s / div.



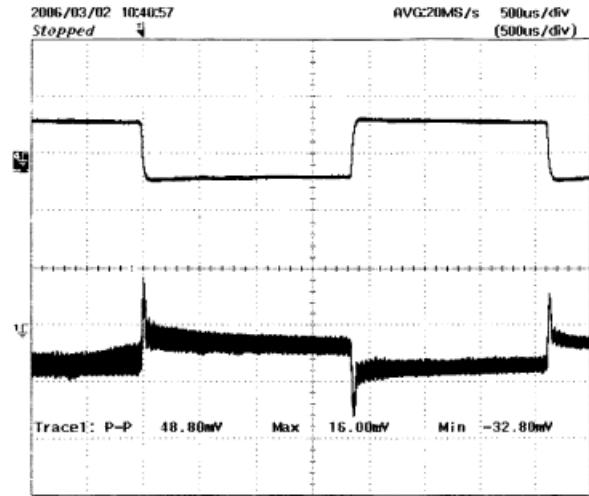
**Figure 19** – Start-Up Profile, 57 VDC, No Load (worst-case).  
Upper:  $V_{OUT}$ , 1 V / div.  
Lower:  $V_{DRAIN}$ , 50 V, 1  $\mu$ s / div.

### 10.3 Load Transient Response (75% to 100% Load Step)

In the figures shown below, signal averaging was used to better enable viewing of the load transient response. The oscilloscope was triggered using the load current step as a trigger source. Since the output switching is random with respect to the load transient, contributions to the output ripple from these sources will average out, leaving the contribution only from the load step response.



**Figure 20** – Transient Response,  
36 VDC, 75-100-75% Load Step.  
Upper: Load Current, 1 A / div.  
Lower: Output Voltage,  
20 mV, 500 μs / div.



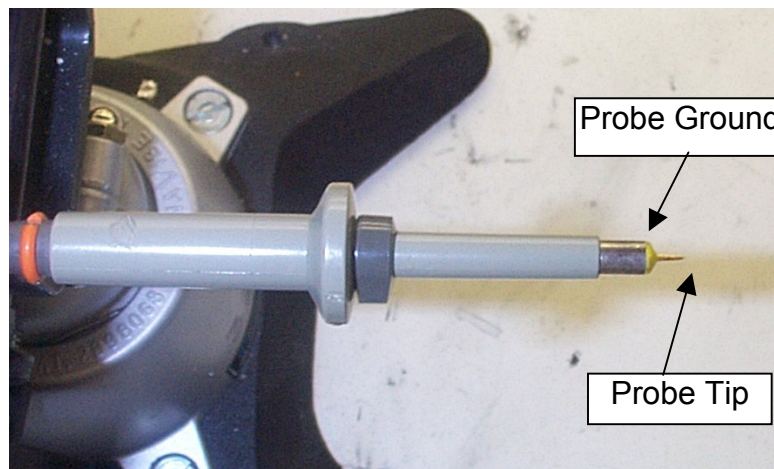
**Figure 21** – Transient Response,  
57 VDC, 75-100-75% Load Step.  
Upper: Load Current, 1 A / div.  
Lower: Output Voltage,  
20 mV, 500 μs / div.

## 10.4 Output Ripple Measurements

### 10.4.1 Ripple Measurement Technique

For DC output ripple measurements, a modified oscilloscope test probe must be utilized in order to reduce spurious signal pickup. Details of the probe modification are provided in Figures 22 and 23.

The 5125BA probe adapter is affixed with two capacitors tied in parallel across the probe tip. The capacitors include one (1) 0.1  $\mu\text{F}/50\text{ V}$  ceramic type and one (1) 1.0  $\mu\text{F}/50\text{ V}$  aluminum electrolytic. **Since the aluminum electrolytic type capacitor is polarized, proper polarity must be observed when connecting it to the output (see below).**



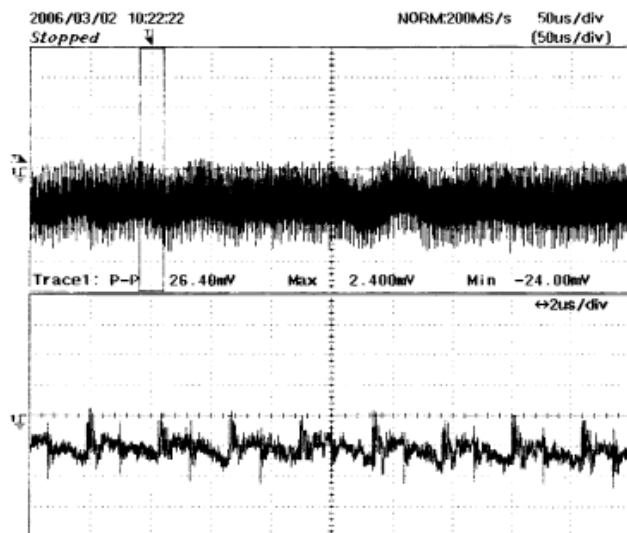
**Figure 22** – Oscilloscope Probe Prepared for Ripple Measurement (End cap and ground lead removed).



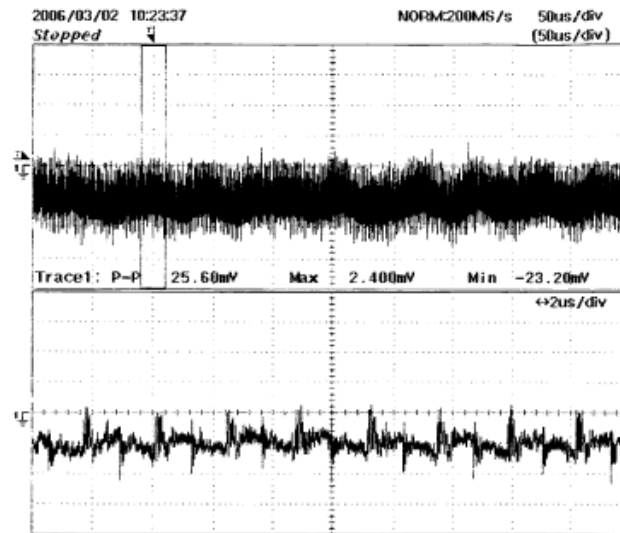
**Figure 23** – Oscilloscope Probe with Probe Master 5125BA BNC Adapter (Modified with wires for probe ground for ripple measurement, and two parallel decoupling capacitors added).



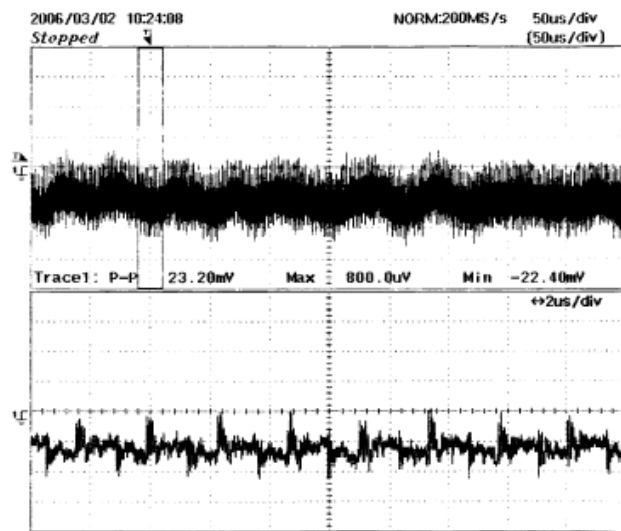
10.4.2 Output Ripple Measurements



**Figure 24** – Ripple, 36 VDC, Full Load.  
Upper: 50  $\mu$ s / div, 10 mV / div.  
Lower: 2  $\mu$ s / div, 10 mV / div.



**Figure 25** – Ripple, 48 VDC, Full Load.  
Upper: 50  $\mu$ s / div, 10 mV / div.  
Lower: 2  $\mu$ s / div, 10 mV / div.



**Figure 26** – Ripple, 57 VDC, Full Load.  
Upper: 50  $\mu$ s / div, 10 mV / div.  
Lower: 2  $\mu$ s / div, 10 mV / div.



## 11 Revision History

<b>Date</b>	<b>Author</b>	<b>Revision</b>	<b>Description &amp; changes</b>
January 3, 2006	RM/LN/ME	1.0	Initial release
April 13 2006	RM	1.1	Updated photo, layout, schematic and BOM





**Notes**



## Notes



**Notes**



**For the latest updates, visit our website: [www.powerint.com](http://www.powerint.com)**

Power Integrations reserves the right to make changes to its products at any time to improve reliability or manufacturability. Power Integrations does not assume any liability arising from the use of any device or circuit described herein. POWER INTEGRATIONS MAKES NO WARRANTY HEREIN AND SPECIFICALLY DISCLAIMS ALL WARRANTIES INCLUDING, WITHOUT LIMITATION, THE IMPLIED WARRANTIES OF MERCHANTABILITY, FITNESS FOR A PARTICULAR PURPOSE, AND NON-INFRINGEMENT OF THIRD PARTY RIGHTS.

#### PATENT INFORMATION

The products and applications illustrated herein (including transformer construction and circuits external to the products) may be covered by one or more U.S. and foreign patents, or potentially by pending U.S. and foreign patent applications assigned to Power Integrations. A complete list of Power Integrations' patents may be found at [www.powerint.com](http://www.powerint.com). Power Integrations grants its customers a license under certain patent rights as set forth at <http://www.powerint.com/ip.htm>.

The PI Logo, **TOPSwitch**, **TinySwitch**, **LinkSwitch**, **DPA-Switch**, **PeakSwitch**, **EcoSmart**, **Clampless**, **E-Shield**, **Filterfuse**, **PI Expert** and **PI FACTS** are trademarks of Power Integrations, Inc. Other trademarks are property of their respective companies. ©Copyright 2006 Power Integrations, Inc.

## Power Integrations Worldwide Sales Support Locations

#### WORLD HEADQUARTERS

5245 Hellyer Avenue  
San Jose, CA 95138, USA.  
Main: +1-408-414-9200  
Customer Service:  
Phone: +1-408-414-9665  
Fax: +1-408-414-9765  
*e-mail: [usasales@powerint.com](mailto:usasales@powerint.com)*

#### GERMANY

Rueckertstrasse 3  
D-80336, Munich  
Germany  
Phone: +49-89-5527-3910  
Fax: +49-89-5527-3920  
*e-mail: [eurossales@powerint.com](mailto:eurossales@powerint.com)*

#### JAPAN

Keihin Tatemono 1<sup>st</sup> Bldg  
2-12-20  
Shin-Yokohama, Kohoku-ku,  
Yokohama-shi, Kanagawa ken,  
Japan 222-0033  
Phone: +81-45-471-1021  
Fax: +81-45-471-3717  
*e-mail: [japansales@powerint.com](mailto:japansales@powerint.com)*

#### TAIWAN

5F, No. 318, Nei Hu Rd., Sec. 1  
Nei Hu Dist.  
Taipei, Taiwan 114, R.O.C.  
Phone: +886-2-2659-4570  
Fax: +886-2-2659-4550  
*e-mail: [taiwansales@powerint.com](mailto:taiwansales@powerint.com)*

#### CHINA (SHANGHAI)

Rm 807-808A,  
Pacheer Commercial Centre,  
555 Nanjing Rd. West  
Shanghai, P.R.C. 200041  
Phone: +86-21-6215-5548  
Fax: +86-21-6215-2468  
*e-mail: [chinasales@powerint.com](mailto:chinasales@powerint.com)*

#### INDIA

261/A, Ground Floor  
7th Main, 17th Cross,  
Sadashivanagar  
Bangalore, India 560080  
Phone: +91-80-5113-8020  
Fax: +91-80-5113-8023  
*e-mail: [indiasales@powerint.com](mailto:indiasales@powerint.com)*

#### KOREA

RM 602, 6FL  
Korea City Air Terminal B/D,  
159-6  
Samsung-Dong, Kangnam-Gu,  
Seoul, 135-728, Korea  
Phone: +82-2-2016-6610  
Fax: +82-2-2016-6630  
*e-mail: [koreasales@powerint.com](mailto:koreasales@powerint.com)*

#### EUROPE HQ

1st Floor, St. James's House  
East Street, Farnham  
Surrey, GU9 7TJ  
United Kingdom  
Phone: +44 (0) 1252-730-140  
Fax: +44 (0) 1252-727-689  
*e-mail: [eurossales@powerint.com](mailto:eurossales@powerint.com)*

#### CHINA (SHENZHEN)

Room 2206-2207, Block A,  
Elec. Sci. Tech. Bldg.  
2070 Shennan Zhong Rd.  
Shenzhen, Guangdong,  
China, 518031  
Phone: +86-755-8379-3243  
Fax: +86-755-8379-5828  
*e-mail: [chinasales@powerint.com](mailto:chinasales@powerint.com)*

#### ITALY

Via Vittorio Veneto 12  
20091 Bresso MI  
Italy  
Phone: +39-028-928-6000  
Fax: +39-028-928-6009  
*e-mail: [eurossales@powerint.com](mailto:eurossales@powerint.com)*

#### SINGAPORE

51 Newton Road,  
#15-08/10 Goldhill Plaza,  
Singapore, 308900  
Phone: +65-6358-2160  
Fax: +65-6358-2015  
*e-mail: [singaporesales@powerint.com](mailto:singaporesales@powerint.com)*

#### APPLICATIONS HOTLINE

World Wide +1-408-414-9660

#### APPLICATIONS FAX

World Wide +1-408-414-9760



**Power Integrations, Inc.**

Tel: +1 408 414 9200 Fax: +1 408 414 9201  
[www.powerint.com](http://www.powerint.com)