

Silicon Carbide Schottky Diode

- Worlds first 600V Schottky diode
- Revolutionary semiconductor material - Silicon Carbide
- Switching behavior benchmark
- No reverse recovery
- No temperature influence on the switching behavior
- No forward recovery

Product Summary

V_{RRM}	600	V
Q_C	30	nC
I_F	12	A

P-TO220-2-2.

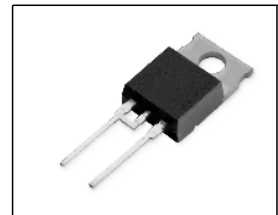

Type	Package	Ordering Code	Marking	Pin 1	Pin 2	Pin 3
SDT12S60	P-TO220-2-2.	Q67040-S4470	D12S60	C	A	

Maximum Ratings, at $T_j = 25\text{ }^\circ\text{C}$, unless otherwise specified

Parameter	Symbol	Value	Unit
Continuous forward current, $T_C=100^\circ\text{C}$	I_F	12	A
RMS forward current, $f=50\text{Hz}$	I_{FRMS}	17	
Surge non repetitive forward current, sine halfwave $T_C=25^\circ\text{C}$, $t_p=10\text{ms}$	I_{FSM}	36	
Repetitive peak forward current $T_j=150^\circ\text{C}$, $T_C=100^\circ\text{C}$, $D=0.1$	I_{FRM}	49	
Non repetitive peak forward current $t_p=10\mu\text{s}$, $T_C=25^\circ\text{C}$	I_{FMAX}	120	
i^2t value, $T_C=25^\circ\text{C}$, $t_p=10\text{ms}$	$\int i^2 dt$	6.48	A ² s
Repetitive peak reverse voltage	V_{RRM}	600	V
Surge peak reverse voltage	V_{RSM}	600	
Power dissipation, $T_C=25^\circ\text{C}$	P_{tot}	88.2	W
Operating and storage temperature	T_j, T_{stg}	-55... +175	$^\circ\text{C}$

Thermal Characteristics

Parameter	Symbol	Values			Unit
		min.	typ.	max.	
Characteristics					
Thermal resistance, junction - case	R_{thJC}	-	-	1.7	K/W
Thermal resistance, junction - ambient, leaded	R_{thJA}	-	-	62	

Electrical Characteristics, at $T_j = 25\text{ }^\circ\text{C}$, unless otherwise specified

Parameter	Symbol	Values			Unit
		min.	typ.	max.	
Static Characteristics					
Diode forward voltage $I_F=12\text{A}$, $T_j=25\text{ }^\circ\text{C}$ $I_F=12\text{A}$, $T_j=150\text{ }^\circ\text{C}$	V_F	-	1.5 1.7	1.7 2.1	V
Reverse current $V_R=600\text{V}$, $T_j=25\text{ }^\circ\text{C}$ $V_R=600\text{V}$, $T_j=150\text{ }^\circ\text{C}$	I_R	-	40 100	400 2000	

Electrical Characteristics, at $T_j = 25\text{ }^\circ\text{C}$, unless otherwise specified

Parameter	Symbol	Values			Unit
		min.	typ.	max.	
AC Characteristics					
Total capacitive charge $V_R=400\text{V}$, $I_F=12\text{A}$, $dI_F/dt=200\text{A}/\mu\text{s}$, $T_j=150\text{ }^\circ\text{C}$	Q_C	-	30	-	nC
Switching time $V_R=400\text{V}$, $I_F=12\text{A}$, $dI_F/dt=200\text{A}/\mu\text{s}$, $T_j=150\text{ }^\circ\text{C}$	t_{rr}	-	n.a.	-	ns
Total capacitance $V_R=1\text{V}$, $T_C=25\text{ }^\circ\text{C}$, $f=1\text{MHz}$ $V_R=300\text{V}$, $T_C=25\text{ }^\circ\text{C}$, $f=1\text{MHz}$ $V_R=600\text{V}$, $T_C=25\text{ }^\circ\text{C}$, $f=1\text{MHz}$	C	-	450 45 43	-	pF

1 Power dissipation

$$P_{tot} = f(T_C)$$

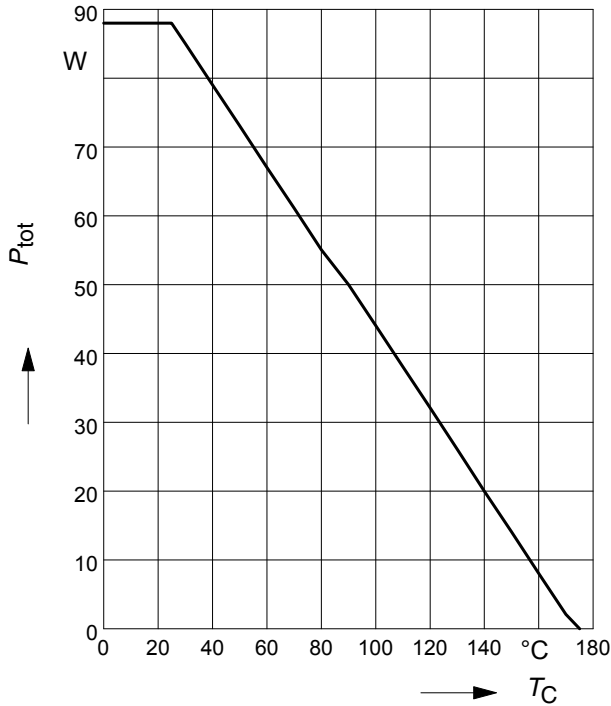

2 Diode forward current

$$I_F = f(T_C)$$

parameter: $T_j \leq 175^\circ\text{C}$

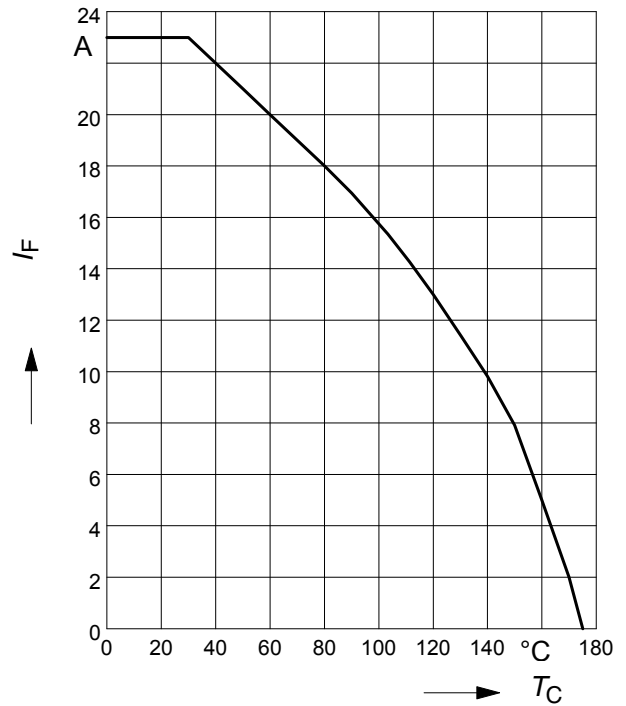

3 Typ. forward characteristic

$$I_F = f(V_F)$$

parameter: T_j , $t_p = 350 \mu\text{s}$

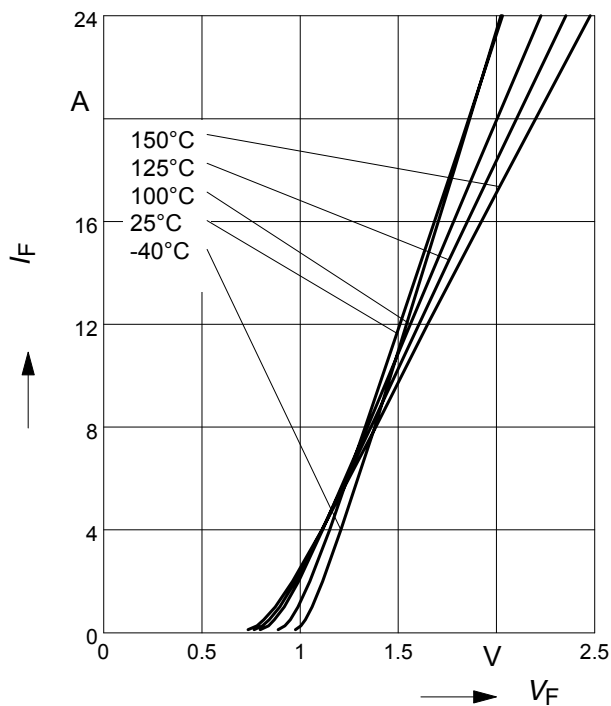

4 Typ. forward power dissipation vs. average forward current

$$P_{F(AV)} = f(I_F) \quad T_C = 100^\circ\text{C}, d = t_p/T$$

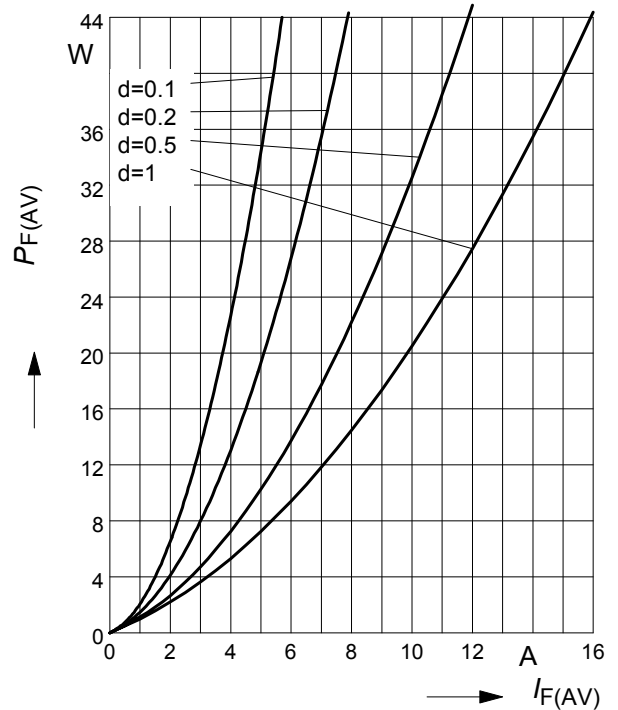

5 Typ. reverse current vs. reverse voltage

$$I_R = f(V_R)$$

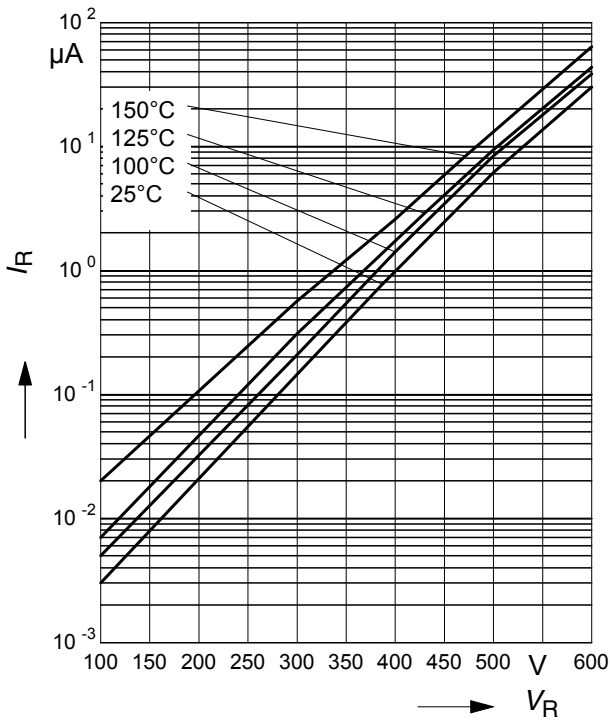

6 Transient thermal impedance

$$Z_{thJC} = f(t_p)$$

parameter : $D = t_p/T$

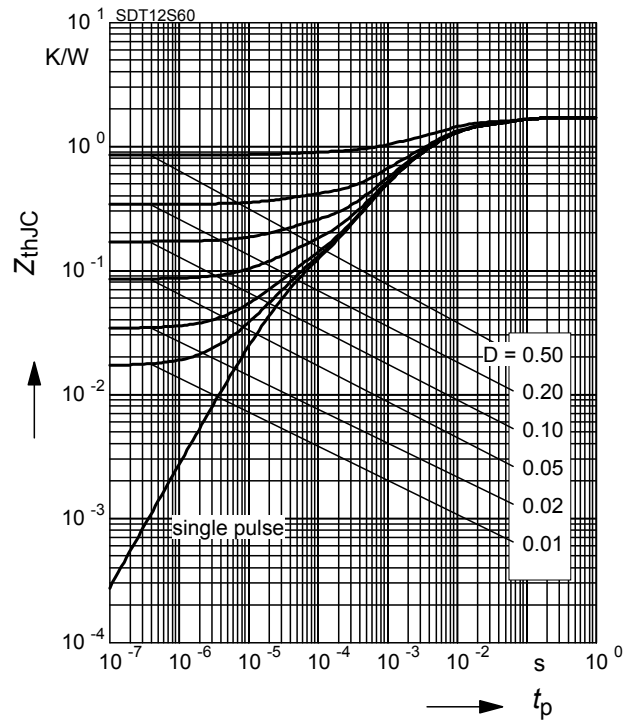

7 Typ. capacitance vs. reverse voltage

$$C = f(V_R)$$

parameter: $T_C = 25^\circ\text{C}$, $f = 1\text{ MHz}$

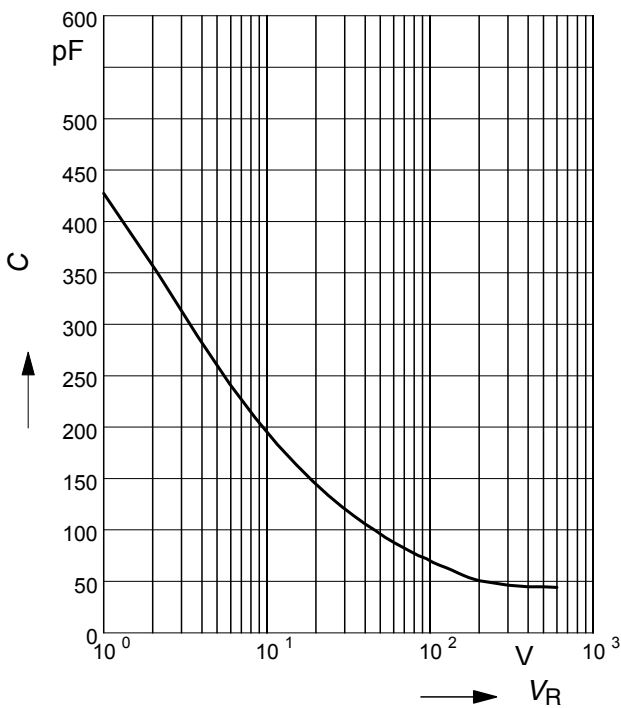

8 Typ. C stored energy

$$E_C = f(V_R)$$

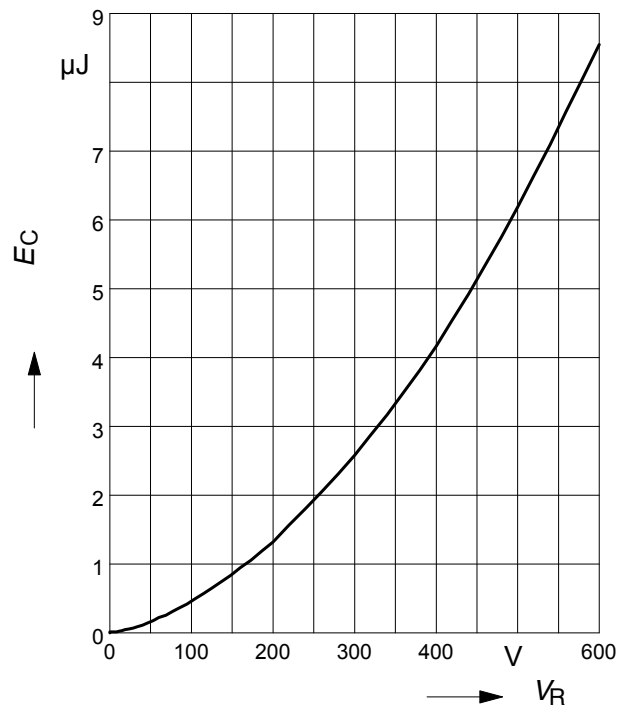

9 Typ. capacitive charge vs. current slope

$$Q_c = f(di_F/dt)$$

parameter: $T_j = 150\text{ }^\circ\text{C}$

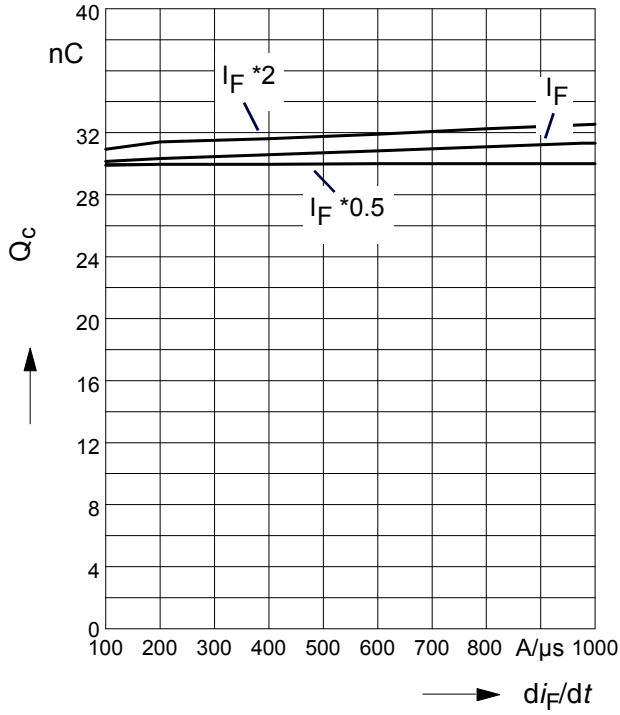

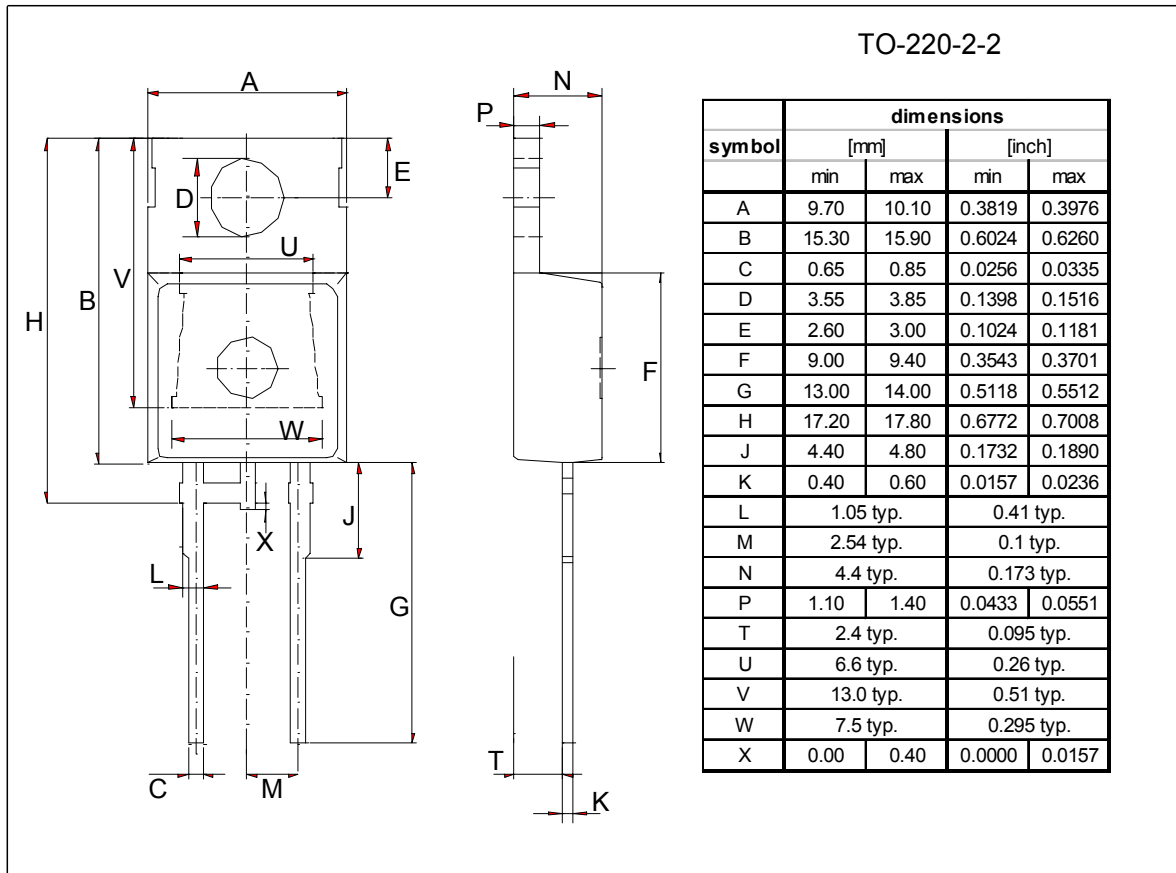

Published by
Infineon Technologies AG,
Bereichs Kommunikation
St.-Martin-Strasse 53,
D-81541 München
© Infineon Technologies AG 1999
All Rights Reserved.

Attention please!

The information herein is given to describe certain components and shall not be considered as warranted characteristics.

Terms of delivery and rights to technical change reserved.

We hereby disclaim any and all warranties, including but not limited to warranties of non-infringement, regarding circuits, descriptions and charts stated herein.

Infineon Technologies is an approved CECC manufacturer.

Information

For further information on technology, delivery terms and conditions and prices please contact your nearest Infineon Technologies Office in Germany or our Infineon Technologies Representatives worldwide (see address list).

Warnings

Due to technical requirements components may contain dangerous substances.

For information on the types in question please contact your nearest Infineon Technologies Office.

Infineon Technologies Components may only be used in life-support devices or systems with the express written approval of Infineon Technologies, if a failure of such components can reasonably be expected to cause the failure of that life-support device or system, or to affect the safety or effectiveness of that device or system. Life support devices or systems are intended to be implanted in the human body, or to support and/or maintain and sustain and/or protect human life. If they fail, it is reasonable to assume that the health of the user or other persons may be endangered.

This datasheet has been download from:

www.datasheetcatalog.com

Datasheets for electronics components.