

■ General Description

The GT1504 is a monolithic integrated circuit that provide all the active functions for a step-down switching regulator, capable of driving a 2A load without additional transistor component. Requiring a minimum number of external component, the board space can be saved easily. The external shutdown function can be controlled by TTL logic level and then come into standby mode. The internal compensation makes feedback control have good line and load regulation without external design. Regarding protected function, thermal shutdown is to prevent over temperature operating from damage, and current limit is against over current operating of the output switch. The GT1504 operates at a switching frequency of 150Khz thus allowing smaller sized filter components than what would be needed with lower frequency switching regulators. Other features include a guaranteed $\pm 4\%$ tolerance on output voltage under specified input voltage and output load conditions, and $\pm 15\%$ on the oscillator frequency. The output version included fixed 3.3V, 5V, 12V, and an adjustable type. The packages are available in a standard 8-lead SOP8.

■ Pin Assignments 脚位排列

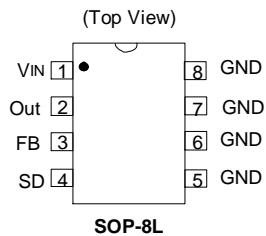

■ Features

- 3.3V, 5V, 12V and adjustable output versions
- Adjustable version output voltage range, 1.23V to 37V $\pm 4\%$ max over line and load condition
- SOP-8L packages
- Voltage mode non-synchronous PWM control
- Thermal-shutdown and current-limit protection
- ON/OFF shutdown control input
- Input voltage range up to 40V
- Output load current: 2A
- 150 kHz fixed frequency internal oscillator
- Low power standby mode
- Built-in switching transistor on chip

■ Applications

- Simple High-efficiency step-down(buck) regulator
- Efficient preregulator for linear regulators
- On-card switching regulators
- Positive to negative converter
- Battery Charger

■ Pin Descriptions 脚位描述

Name	Description
V _{IN}	Operating voltage input. 输入脚
Out	Switching output. 输出脚
Gnd	Ground. 接地脚
FB	Output voltage feedback control. 反馈脚
SD	ON/OFF Shutdown. 使能脚

■ Ordering Information

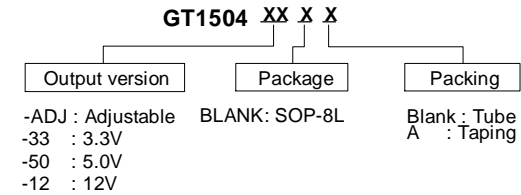

■ Block Diagram

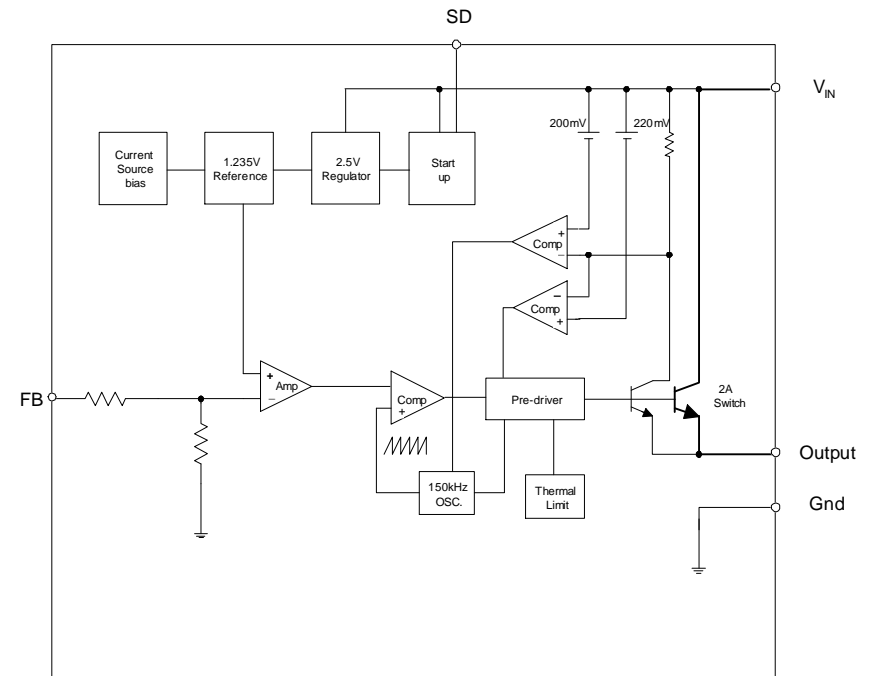

Absolute Maximum Ratings

Symbol 符号	Parameter参数	Rating范围	Unit单位
V _{CC} 输入电压	Supply Voltage	+45	V
V _{SD} 使能电压	ON/OFF Pin input voltage	-0.3 to +25	V
V _{FB} 反馈电压	Feedback Pin voltage	-0.3 to +25	V
V _{OUT} 输出电压	Output voltage to Ground	-1	V
P _D 耗散功率	Power dissipation	Internally limited	W
T _{ST} 储存温度	Storage temperature	-65 to +150	°C
T _{OP} 运行温度	Operating temperature	-40 to +125	°C
V _{OP} 运行电压	Operating voltage	+4.5 to +25	V

Electrical Characteristics (All Output Voltage Versions)

 Unless otherwise specified, V_{IN}=12V for 3.3V, 5V, adjustable version and V_{IN}=24V for the 12V version. I_{LOAD}=0.2A

Symbol	Parameter	Conditions	Min.	Typ.	Max.	Unit
I _B 反馈偏流	Feedback bias current	V _{FB} =1.3V 仅适用于可调版 (Adjustable version only)		-10	-50 -100	nA
F _{OSC} 振荡频率	oscillator frequency		127 110	150	173 173	Khz
F _{scp} 短路保护时的震荡频率	Oscillator frequency of short circuit protect	When current limit occurred and V _{FB} <0.55V 限流出现时		30	70	Khz
V _{SAT} 饱和电压	saturation voltage 饱和电压	I _{OUT} =1.5A no outside circuit 无外部电路 V _{FB} =0V force driver on 强制驱动开		1.25	1.4 1.5	V
DC 死区	Max. Duty Cycle(ON)	V _{FB} =0V force driver on 强制驱动开		100		%
	Min. Duty cycle(OFF)	V _{FB} =12V force driver off 强制驱动关		0		
I _{CL} 极限电流	current limit 极限电流	peak current 峰值电流 no outside circuit 无外围电路 V _{FB} =0 force driver on 强制驱动	2.4	2.8	3.3 3.6	A
I _L	Output = 0V	no outside circuit 无外围电路			-200	uA
	Leakage Current	V _{FB} =12 force driver off 强制驱动关				
I _O	Output = -1V	V _{IN} =24V		-5		mA
I _Q	Quiescent Current 静态电流	V _{FB} =12 force driver off 强制驱动关		5	10	mA
I _{STBY}	Standby Quiescent Current 待机静态电流	ON/OFF pin=5V V _{IN} =24V		70	150 200	uA
V _{IL}	ON/OFF pin logic input threshold voltage 使能阈值输入电压	Low (regulator ON)	-		0.6	V
V _{IH}		High (regulator OFF)	2.0	1.3	-	
I _H	ON/OFF pin logic input current 使能输入电流	V _{LOGIC} =2.5V (OFF)			-0.01	uA
I _L	ON/OFF pin input current	V _{LOGIC} =0.5V (ON)		-0.1	-1	°C
		T _J increasing		175		
T _s	Over temperature shutdown threshold 温控阈值	T _J decreasing		150		

Electrical Characteristics (Continued)

	Symbol	Parameter	Conditions	Typ.	Limit	Unit
GT1504-ADJ	V _{FB} 反馈电压	Output Feedback	5V ≤ V _{IN} ≤ 40V 0.2A ≤ I _{LOAD} ≤ 2A V _{OUT} programmed for 3V	1.235	1.193/1.18 1.267/1.28	V V _{MIN} V _{MAX}
	η效率	Efficiency	V _{IN} = 12V, I _{LOAD} =2A	75		%
GT1504-3.3V	V _{OUT} 输出电压	Output voltage	5.5V ≤ V _{IN} ≤ 40V 0.2A ≤ I _{LOAD} ≤ 2A	3.3	3.168/3.135 3.432/3.465	V V _{MIN} V _{MAX}
	η效率	Efficiency	V _{IN} = 12V, I _{LOAD} =2A	75		%
GT1504-5V	V _{OUT} 输出电压	Output voltage	8V ≤ V _{IN} ≤ 40V 0.2A ≤ I _{LOAD} ≤ 2A	5	4.8/4.75 5.2/5.25	V V _{MIN} V _{MAX}
	η效率	Efficiency	V _{IN} = 12V, I _{LOAD} =2A	80		%
GT1504-12V	V _{OUT} 输出电压	Output voltage	15V ≤ V _{IN} ≤ 40V 0.2A ≤ I _{LOAD} ≤ 2A	12	11.52/11.4 12.48/12.6	V V _{MIN} V _{MAX}
	η效率	Efficiency	V _{IN} = 15V, I _{LOAD} = 2A	90		%

 Specifications with **boldface type** are for full operating temperature range, the other type are for T_J=25_°C.

■ Typical Performance Characteristics

Typical Performance Characteristics
Normalized Output Voltage

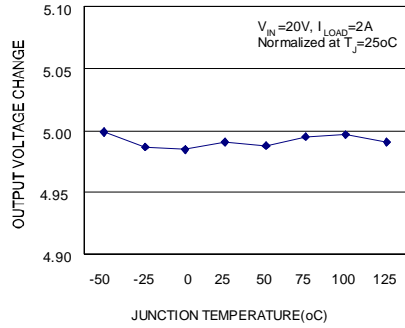

Efficiency

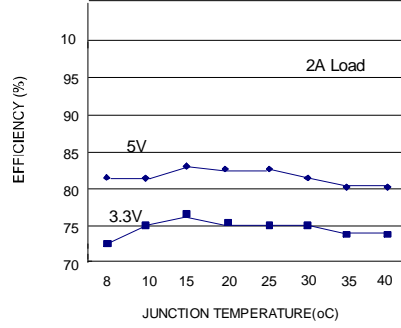

Switch Saturation Voltage

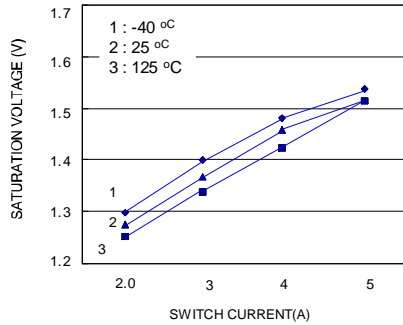

Switch Current Limit

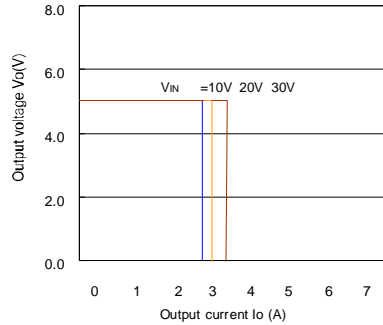

Operating Quiescent Current

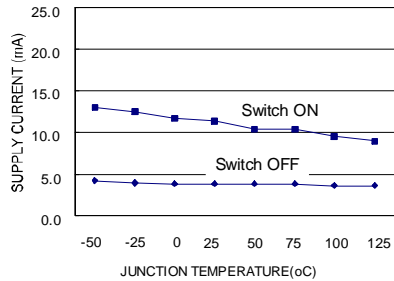

Shutdown Quiescent Current

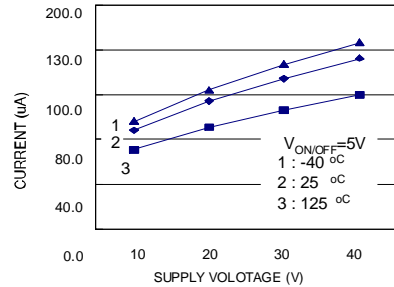

■ Typical Performance Characteristics (Continued)

Minimum Operating Supply Voltage

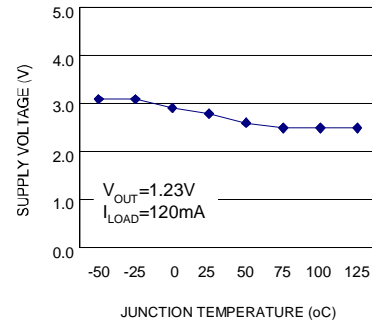

ON/OFF Threshold Voltage

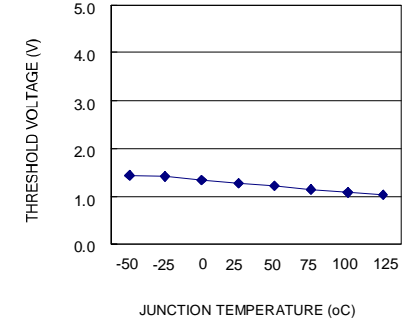

ON/OFF Pin Current (Sinking)

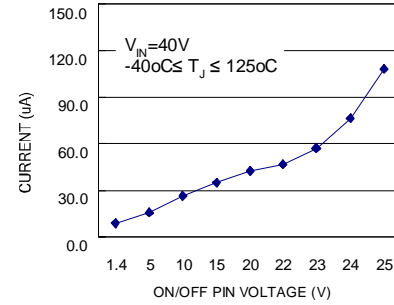

Switch Frequency

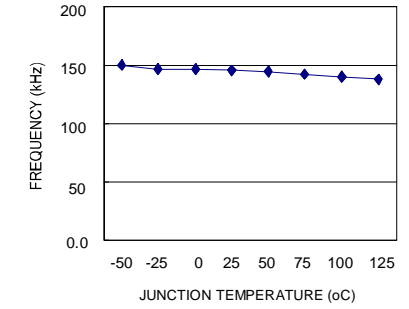

Feedback Pin Bias Current

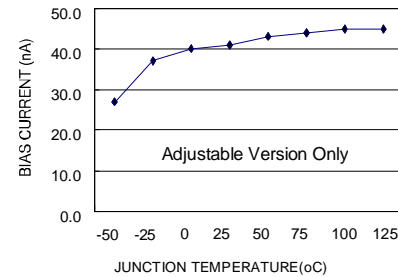

Thermal protection

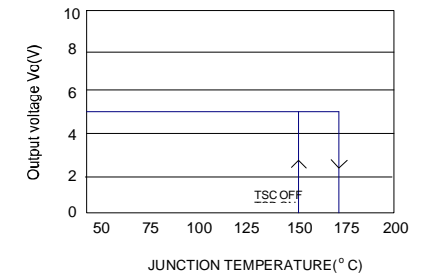

■ Typical Application Circuit

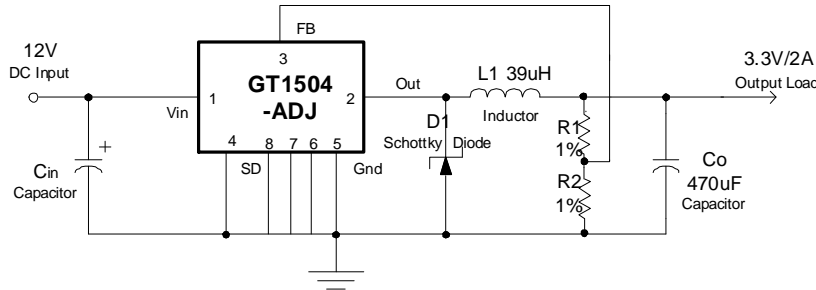

Some standard value of R1 and R2 for most commonly used output voltage are listed below.

VIN(V) /Vo (V)	R1 (KΩ)	R2 (KΩ)	L1 Minimum
24/12	17.6	2	68uH
12/5.0	6	2	33uH
12/3.3	3.3	2	33uH
12/2.5	2	2	27uH
12/1.8	0.91	2	22uH
5.0/3.3	3.4	2	33uH
5.0/2.5	2.1	2	27uH
5.0/1.8	0.95	2	22uH

■ Function Description

Pin Functions

+VIN

This is the positive input supply for the IC switching regulator. A suitable input bypass capacitor must be present at this pin to minimize voltage transients and to supply the switching currents needed by the regulator.

Out

Internal switch and power output. The voltage at this pin switches between (+VIN V_{SAT}) and approximately 0.5V, with a duty cycle of approximately V_{OUT} / V_{IN} . The PC board copper area connected to this pin should be kept a minimum in order to reduce the coupling sensitivity to the circuitry

Ground

Circuit ground.

Feedback

Complete the feedback loop by sensing the regulated output voltage

ON/OFF

Allows the switching regulator circuit to be shutdown using logic level signals thus dropping the total input

supply current to approximately 100uA. Pulling this pin below a threshold voltage of approximately 1.3V turns the regulator on, and pulling this pin above 1.3V (up to a maximum of 25V) shuts the regulator down.

If this shutdown feature is not needed, the ON/OFF pin must be wired to the ground pin, in either case the regulator will be in the ON condition.

Thermal Considerations

The SOP-8 package needs a heat sink under most conditions. The size of the heatsink depends on the input voltage, the output voltage, the load current and the ambient temperature. The GT1504 junction temperature rises above ambient temperature for a 2A load and different input and output voltages. The data for these curves was taken with the GT1504 operating as a buck switching regulator in an ambient temperature of 25°C (still air). These temperature increments are all approximate and are affected by many factors. Some of these factors include board size, shape, thickness, position, location, and even board temperature. Other factors are trace width, total printed circuit copper area, copper thickness, single or double-sided, multi-layer board and amount of solder on the board. Higher ambient temperatures require more heat sinking.

For the best thermal performance, wide copper traces and generous amounts of printed circuit board copper should be used in the board layout. (One exception is the out(switch) pin, which should not have large areas of copper.) Large areas of copper provide the best transfer of heat (lower thermal resistance) to the surrounding air, and moving air lowers the thermal resistance even further.

The effectiveness of the PC board to dissipate heat also depends on the size, quantity and spacing of other components on the board, as well as whether the surrounding air is still or moving. Furthermore, some of these components such as the catch diode will add heat to the PC board and heat can vary as the input voltage changes. For the inductor, depending on the physical size, type of core material and the DC resistance, it could either act as a heat sink taking heat away from the board, or it could add heat to the board.

■ Marking Information

(1) SOP-8L

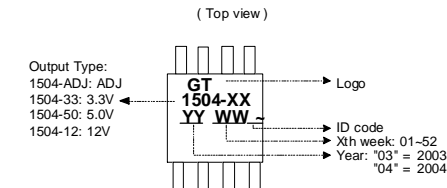

■ Package Information

(1) Package Type: SOP-8L

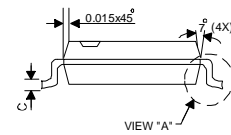
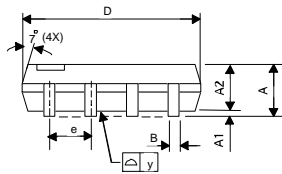
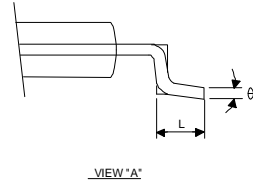
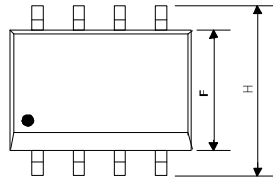

Symbol	Dimensions In Millimeters			Dimensions In Inches		
	Min.	Nom.	Max.	Min.	Nom.	Max.
A	1.40	1.60	1.75	0.055	0.063	0.069
A1	0.10	-	0.25	0.040	-	0.100
A2	1.30	1.45	1.50	0.051	0.057	0.059
B	0.33	0.41	0.51	0.013	0.016	0.020
C	0.19	0.20	0.25	0.0075	0.008	0.010
D	4.80	4.85	5.05	0.189	0.191	0.199
E	3.80	3.91	4.00	0.150	0.154	0.157
e	-	1.27	-	-	0.050	-
H	5.79	5.99	6.20	0.228	0.236	0.244
L	0.38	0.71	1.27	0.015	0.028	0.050
y	-	-	0.10	-	-	0.004
θ	0°	-	8°	0°	-	8°