

▼ General Description

The GA8518 is a voltage mode, step-down DC-DC converter that is designed to meet 4A output current and utilizes PWM control scheme that switches with 300KHz fixed frequency. This device includes a reference voltage source, error amplifier, oscillation circuit, P-channel MOSFET, and etc.

The input voltage range of GA8518 is from 3.6V to 23V, and provides adjustable output voltage range from 0.8V to V_{IN} for customers in application.

The GA8518 provides an enable function that can be controlled by external logic signal and excellent regulation during line or load transient due to the internal compensation. Other features of thermal protection, current limit and short circuit protection are also included. Due to the low Drain-Source resistance of internal power MOSFET, the GA8518 provides a high efficiency step-down application. It can also operate with a maximum duty cycle of 100% for use in low drop-out conditions.

The package is available in a standard SOP-8L.

▼ Features

- Adjustable Output Voltage from 0.8V to V_{IN}
- Operating Input Voltage up to 23V
- Great Output Capability: 4A
- Oscillation Frequency: 300KHz
- Built-in P-channel MOSFET
- External ON/OFF Control Function
- Low Shutdown Current: 1uA
- Current Limit and Thermal Protection
- Short Circuit Protection
- Stable With Low ESR Output Ceramic Capacitor
- SOP-8L Package
- All Products meet Rohs Standard

▼ Applications

- Broadband Communication Device
- LCD TV / Monitor
- Storage Device
- Wireless Application

▼ Typical Application

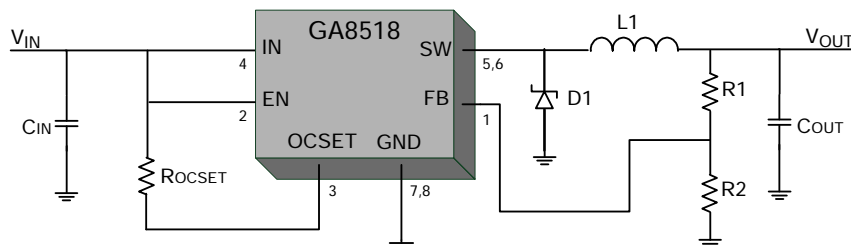

$$* V_{OUT} = V_{FB} \times (1 + R1 / R2)$$

Functional Block Diagram

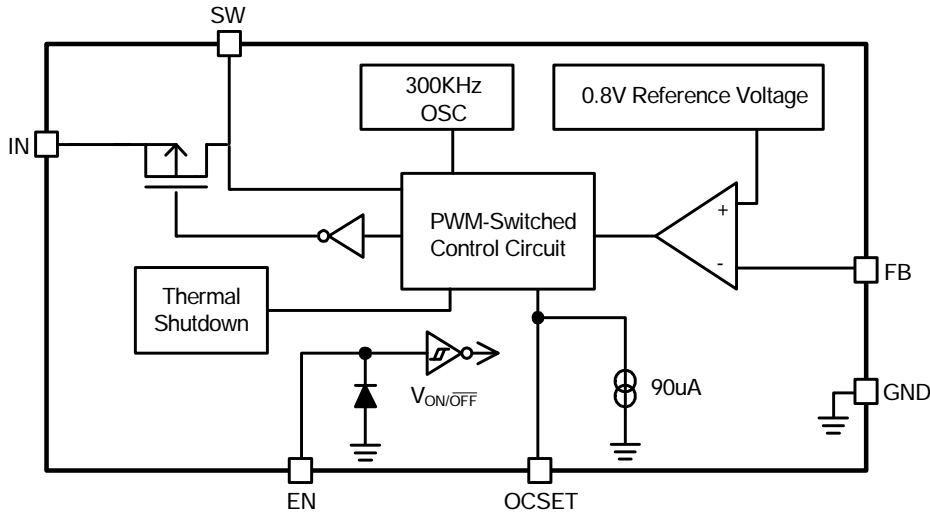

Pin Configurations

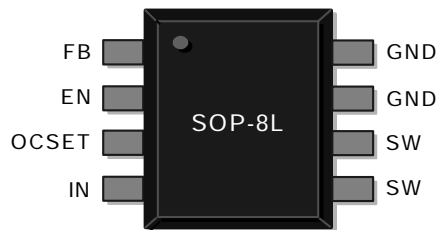

Pin No.	Name	Description
1	FB	This pin senses the feedback voltage to regulate the output voltage. Connect this pin to a resistor divider to set the output voltage.
2	EN	This pin allows an external logic control signal to turn-on/off this device. Float this pin or drive it to low level to turn-off this device, drive it to high level to turn-on this device. If this feature is not needed, connect this pin to IN pin directly.
3	OCSET	Add an external resistor from this pin to IN pin to set peak current.
4	IN	The input pin of the step-down converter. A suitably large capacitor must be connected from this pin to ground to bypass noise on the input of the IC.
5,6	SW	The output pin of the step-down converter. This pin is the switching node that supplies power to the output. Connect a LC filter from this pin to the output load and a rectifier diode to the ground.
7,8	GND	The ground pin of the step-down converter. Connect this pin to the circuit ground.

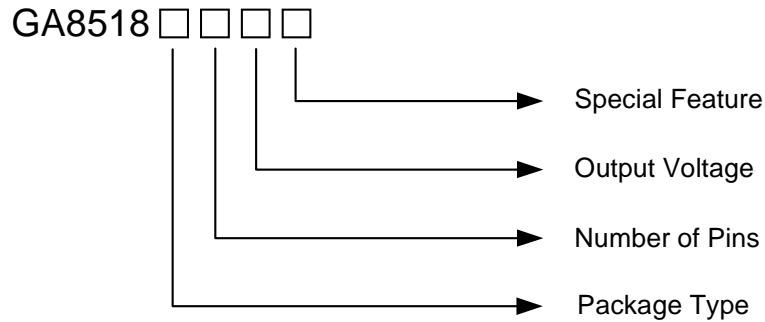
Ordering Information

Package Type	Number of Pins	Output Voltage	Special Feature
J: SOP	G: 8 pin	ADJ: Adjustable version	Blank: Original

Marking Information

①②③ - Product Code

Part Number	Output Voltage	Package Type	Product Code
GA8518JGADJ	ADJ	SOP-8L	AAT

④⑤ - Date Code

Year Week	xxx0	xxx1	xxx2	xxx3	xxx4	xxx5	xxx6	xxx7	xxx8	xxx9
	01	AA	CA	EA	GA	IA	KA	MA	OA	RA
02	AB	CB	EB	GB	IB	KB	MB	OB	RB	TB
.
26	AZ	CZ	EZ	GZ	IZ	KZ	MZ	OZ	RZ	TZ
27	BA	DA	FA	HA	JA	LA	NA	PA	SA	UA
.
51	BY	DY	FY	HY	JY	LY	NY	PY	SY	UY
52	BZ	DZ	FZ	HZ	JZ	LZ	NZ	PZ	SZ	UZ

✓ Absolute Maximum Ratings

Parameter	Rating
Input Voltage	25V
SW Pin Voltage Range	-0.5V ~ $V_{IN}+0.5V$
FB Pin Voltage Range	-0.3V ~ V_{IN}
EN Pin Voltage Range	-0.3V ~ $V_{IN}+0.3V$
Storage Temperature Range	-65°C ~ 150°C
Junction Temperature	150°C
Lead Soldering Temperature (10 sec)	300°C

These are stress ratings only and functional operation is not implied. Exposure to absolute maximum ratings for prolonged time periods may affect device reliability. All voltages are with respect to ground.

✓ Recommended Operating Conditions

Parameter	Rating
Input Voltage Range	3.6V ~ 23V
Junction Temperature Range	-40°C ~ 125°C

These are conditions under which the device functions but the specifications might not be guaranteed. For guaranteed specifications and test conditions, please see the *Electrical Specifications*.

✓ Package Information

Parameter	Package	Symbol	Maximum	Unit
Thermal Resistance (Junction to Case)	SOP-8L	θ_{JC}	20	°C / W
Thermal Resistance (Junction to Ambient)		θ_{JA}	60	°C / W

▼ Electrical Specifications

$V_{IN}=12V$, V_{OUT} set to 3.3V, $T_A=25^{\circ}C$, unless otherwise noted.

Parameter	Symbol	Test Condition	Min	Typ	Max	Units
Feedback Voltage	V_{FB}	$I_{LOAD}=0.1A$	0.784	0.8	0.816	V
Efficiency	η	$V_{IN}=12V$, $V_{OUT}=5V$, $I_{LOAD}=4A$		91		%
		$V_{IN}=5V$, $V_{OUT}=3.3V$, $I_{LOAD}=4A$		89		
Oscillation Frequency	F_{OSC}	$V_{IN}=3.6\sim 23V$, $I_{LOAD}=0.2\sim 4A$	240	300	360	KHz
Frequency of Short Circuit Protection	F_{SCP}	$V_{IN}=3.6\sim 23V$	30	50	70	KHz
Duty Cycle	DC	$V_{FB}=0V$ force driver on		100		%
		$V_{FB}=1.5V$ force driver off		0		
Internal MOSFET On Resistance	$R_{DS(ON)}$	$V_{IN}=5V$, $V_{FB}=0V$		40	45	$m\Omega$
		$V_{IN}=12V$, $V_{FB}=0V$		30	35	
Quiescent Current	I_Q	$V_{IN}=3.6V\sim 23V$, $V_{FB}=1.5V$ force drive off		3	10	mA
Shutdown Current	I_S	EN pin = GND		1	10	μA
EN Pin Input Threshold Voltage	V_{EN}	Regulator OFF		1.3	0.8	V
		Regulator ON	2.0			
EN Pin Bias Current	I_{EN}	Regulator OFF		1		μA
		Regulator ON		20		
FB Pin Bias Current	I_{FB}	$I_{LOAD}=0.2A$		0.1	0.5	μA
OCSET Pin Bias Current	I_{OCSET}	$I_{LOAD}=0.2A$	75	90	105	μA
Line Regulation	ΔV_{LINE}	$V_{IN}=3.6V\sim 23V$, $I_{LOAD}=0.2A$		2		%
Load Regulation	ΔV_{LOAD}	$I_{LOAD}=0.2A\sim 4A$		0.1		%
Over Temperature Shutdown	T_{SD}			150		$^{\circ}C$
Over Temperature Shutdown Hysteresis	T_{HYS}			25		$^{\circ}C$

v Typical Performance Characteristics

$V_{IN}=12V$, V_{OUT} set to 3.3V, $T_A=25^\circ C$, unless otherwise noted.

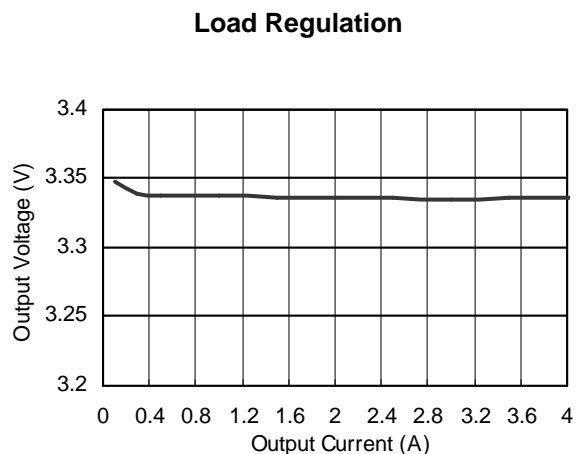
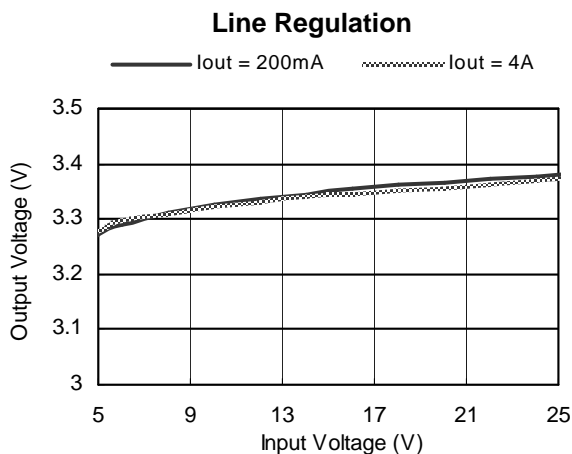
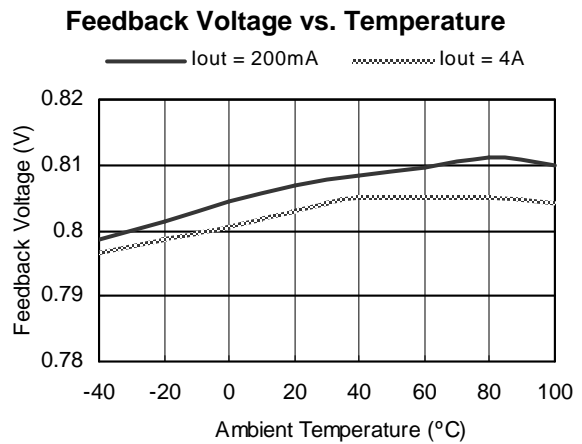
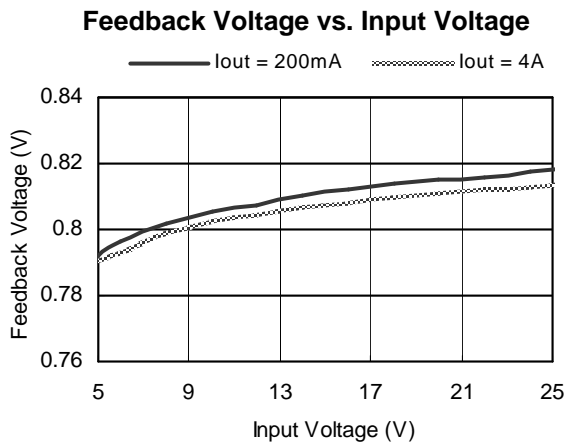
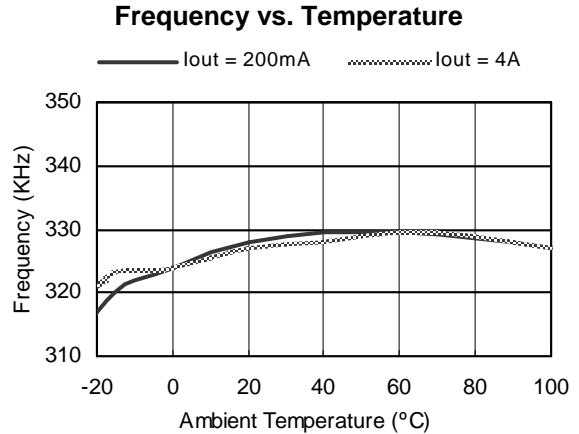
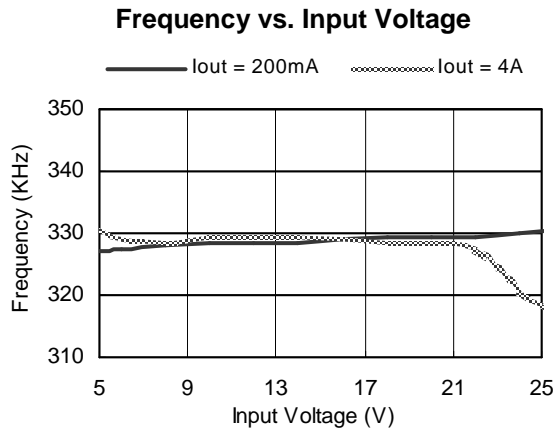

▼ **Typical Performance Characteristics (Contd.)**

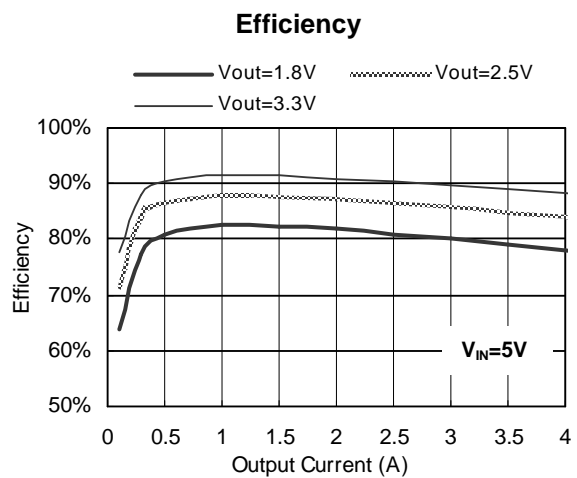
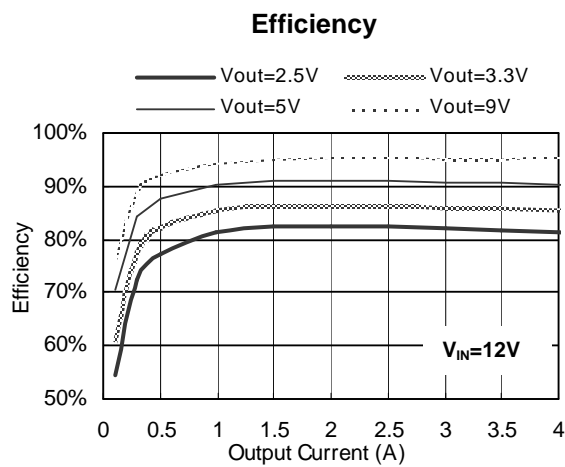
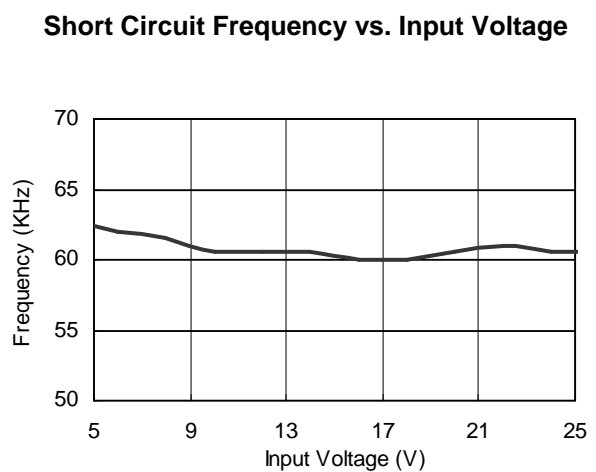
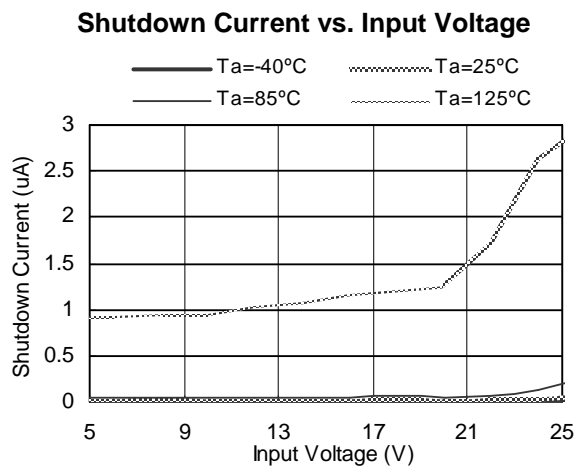
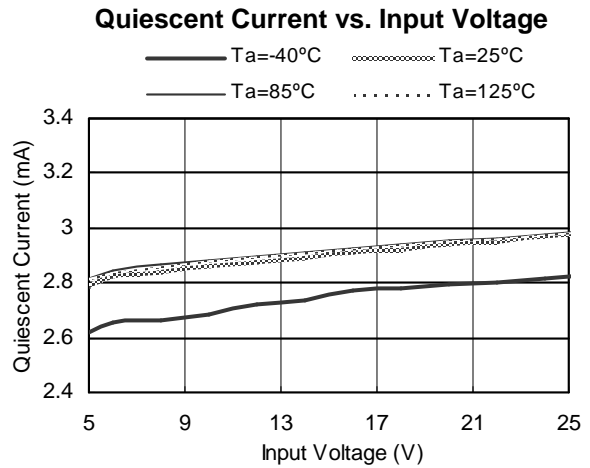
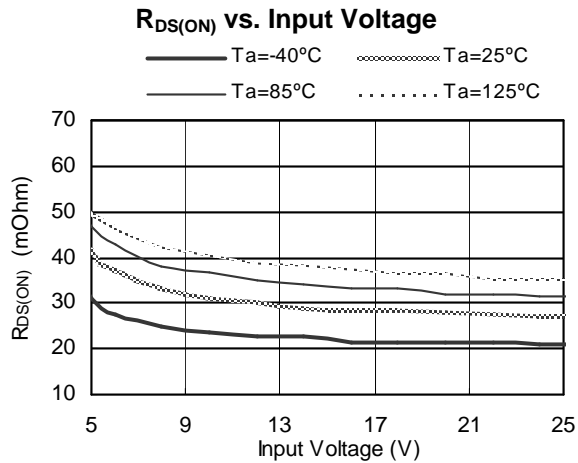

▼ **Typical Performance Characteristics (Contd.)**

Output Voltage Ripple - CCM

$V_{IN}=12V$ $V_{OUT}=5V$, $I_{LOAD}=4A$

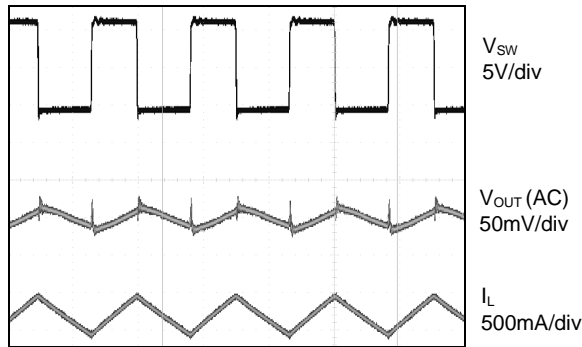

Time Base: 2us/div

Output Voltage Ripple - DCM

$V_{IN}=12V$ $V_{OUT}=5V$, $I_{LOAD}=0.05A$

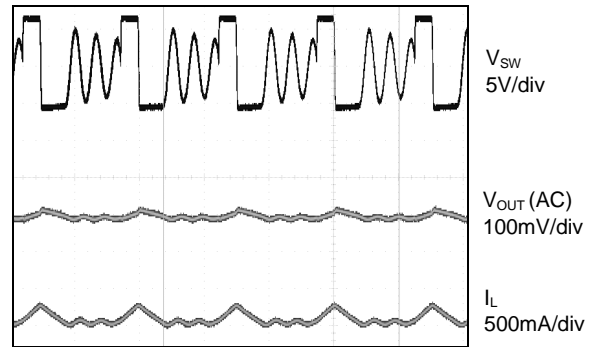

Time Base: 2us/div

Start-up

$V_{IN}=12V$ $V_{OUT}=5V$, $I_{LOAD}=4A$

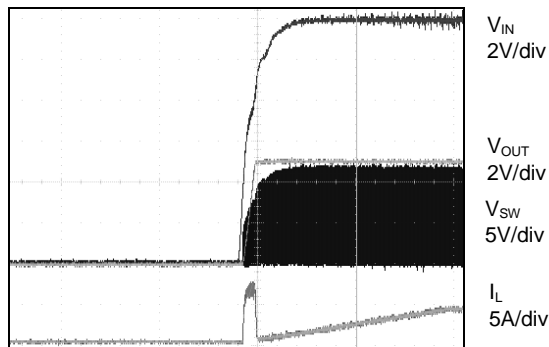

Time Base: 2ms/div

Start-up From Enable

$V_{IN}=12V$ $V_{OUT}=5V$, $I_{LOAD}=4A$

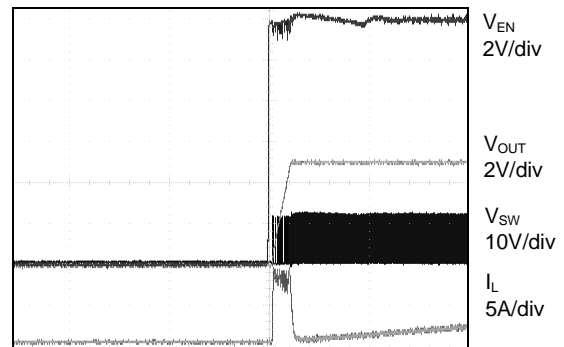

Time Base: 1ms/div

Load Transient

$V_{IN}=12V$ $V_{OUT}=5V$, $I_{LOAD}=200mA-4A$
 $T_{ON}=T_{OFF}=1ms$, $T_r=T_f=100mA/us$

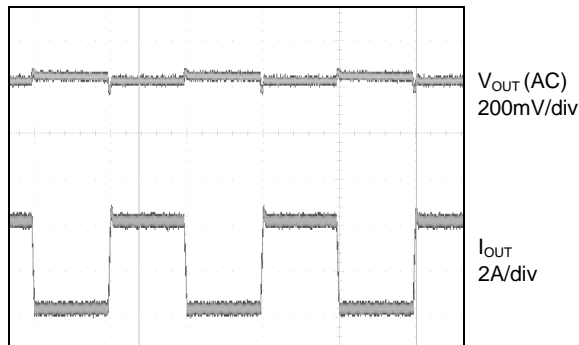

Time Base: 1ms/div

Short Circuit Protection

$V_{IN}=12V$ $V_{OUT}=5V$, $I_{LOAD}=4A$

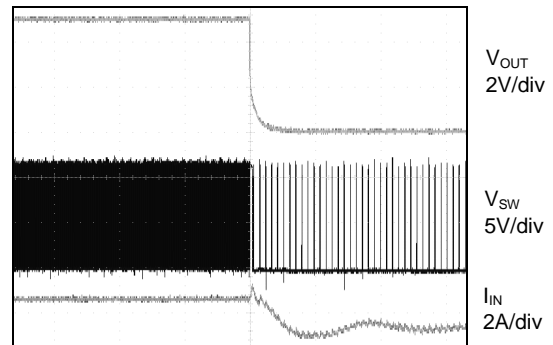

Time Base: 200us/div

Application Information

Output Voltage Programming

This device develops a band-gap between the feedback pin and ground pin. Therefore, the output voltage can be formed by R1 and R2. Use 1% metal film resistors for the lowest temperature coefficient and the best stability. Select lower resistor value to minimize noise pickup in the sensitive feedback pin, or higher resistor value to improve efficiency.

The output voltage is given by the following formula:

$$V_{OUT} = V_{FB} \times (1 + R1 / R2) \quad \text{where } V_{FB} = 0.8V$$

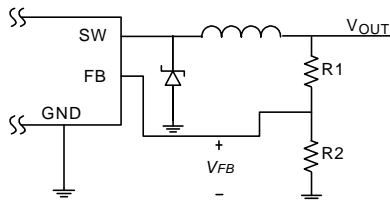

Short Circuit Protection

This device includes short circuit protection. When the output is shorted to ground, the protection circuit will be triggered and force the oscillation frequency down to approximately 50KHz. The oscillation frequency will return to the normal value once the output voltage or the feedback voltage rises above 0V.

Peak Current Setting

This device reserves OCSET pin to set the switching peak current. In general, the peak current must be 1.5 times of the continuous output current. It can be calculated as below:

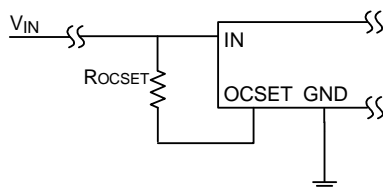

$$I_{PK} = (I_{OCSET} \times R_{OCSET}) / R_{DS(ON)}$$

Where:

I_{PK} ; Peak Current

I_{OCSET} ; OCSET Pin Bias Current

$R_{DS(ON)}$; Internal MOSFET On-Resistance

Delay Start-up

The following circuit uses the EN pin to provide a time delay between the input voltage is applied and the output voltage comes up. As the instant of the input voltage rises, the charging of capacitor C_{DELAY} pulls the EN pin low, keeping the device off. Once the capacitor voltage rises above the EN pin threshold voltage, the device will start to operate.

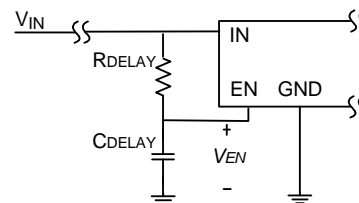

For example, setting at $V_{IN}=12V$, $R_{DELAY}=100K\Omega$, $C_{DELAY}=0.1\mu F$. The start-up delay time can be calculated as below:

$$V_C = V_{IN} \times (1 - e^{-T/\tau}) > V_{EN}$$

$$T > 1.147mS$$

Where:

V_C is Capacitor Voltage

$V_{EN} = 1.3V$ (Typ.); EN Pin Threshold Voltage

T = Delay Time

$$\tau = R_{DELAY} \times C_{DELAY}$$

This feature is useful in situations where the input power source is limited in the amount of current it can deliver. It allows the input voltage to rise to a higher voltage before the device starts operating.

Snubber Circuit

The simple RC snubber is used for voltage transient and ringing suppression. The high frequency ringing and voltage overshooting at the SW pin is caused by fast switching transition and resonating circuit parasitical elements in the power circuit. It maybe generates EMI and interferes with circuit performance.

Reserve a snubber circuit in the PC board is preferred to damp the ringing due to the parasitical capacitors and inductors of layout. The following circuit is a simple RC snubber:

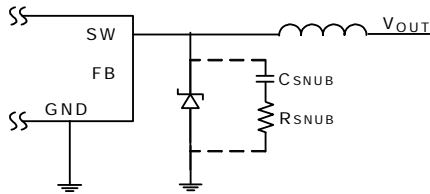

Choose the value of RC network by the following procedure:

- (1) Measure the voltage ringing frequency (f_R) of the SW pin.
- (2) Find a small capacitor and place it across the SW pin and the GND pin to damp the ringing frequency by half.
- (3) The parasitical capacitance (C_{PAR}) at the SW pin is 1/3 the value of the added capacitance above. The parasitical inductance (L_{PAR}) at the SW pin is:

$$L_{PAR} = \frac{I}{(2\pi f_R)^2 \times C_{PAR}}$$

- (4) Select the value of C_{SNUB} that should be more than 2~4 times the value of C_{PAR} but must be small enough so that the power dissipation of R_{SNUB} is kept to a minimum. The power rating of R_{SNUB} can be calculated by following formula:

$$P_{RSNUB} = C_{SNUB} \times V_{IN}^2 \times f_S$$

- (5) Calculate the value of R_{SNUB} by the following formula and adjust the value to meet the expectative peak voltage.

$$R_{SNUB} = 2\pi \times f_R \times L_{PAR}$$

Thermal Considerations

Thermal protection limits total power dissipation in this device. When the junction temperature reaches approximately 150°C, the thermal sensor signals the shutdown logic turning off this device. The thermal sensor will turn this device on again after the IC's junction temperature cools by 25°C.

For continuous operation, do not exceed the maximum operation junction temperature 125°C.

The power dissipation across this device can be calculated by the following formula:

$$P_D = (I_{LOAD})^2 \times R_{DS(ON)} \times D + 1/2 \times V_{IN} \times I_{OUT} \times (t_r + t_f) \times f_S + Q_{Gate} \times V_{GS} \times f_S + I_Q \times V_{IN}$$

Where:

D: Duty Cycle

f_S : Switching Frequency

V_{GS} : Power MOSFET Gate Voltage

I_Q : Quiescent Current

The t_r , t_f , and Q_{Gate} are the rising, falling time, and gate charge of the internal power switch. The typical value of $(t_r + t_f)$ is approximately 52ns, and the Q_{Gate} is approximately 17nC. The V_{GS} is approximately equal V_{IN} .

The maximum power dissipation of this device depends on the thermal resistance of the IC package and PCB layout, the temperature difference between the die junction and ambient air, and the rate of airflow. The maximum power dissipation can be calculated by the following formula:

$$P_{D(MAX)} = (T_J - T_A) / \theta_{JA}$$

Where $T_J - T_A$ is the temperature difference between the die junction and surrounding environment, θ_{JA} is the thermal resistance from the junction to the surrounding environment.

The value of junction to case thermal resistance θ_{JC} is also popular to users. This thermal parameter is convenient for users to estimate the internal junction operated temperature of packages while IC operating. The operated junction temperature can be calculated by the following formula:

$$T_J = T_C + P_D \times \theta_{JC}$$

T_C is the package case temperature measured by thermal sensor. Therefore it's easy to estimate the junction temperature by any condition.

There are many factors affect the thermal resistance. Some of these factors include trace width, copper thickness, total PCB copper area, and etc.

For the best thermal performance, wide copper traces and generous amounts of PCB copper should be used in the board layout. If further improve thermal characteristics are needed, double sided and multi-layer PCB with large copper areas and airflow will be recommended.

Layout Considerations

PC board layout is very important, especially for switching regulators of high frequencies and large peak currents. A good layout minimizes EMI on the feedback path and provides best efficiency. The following layout guides should be used to ensure proper operation of this device.

- (1) The power charge path that consists of the IN trace, the SW trace, external inductor and the GND trace should be kept wide and as short as possible.
- (2) The power discharge path that consists of the SW trace, external inductor, external diode and the GND trace should be kept wide and as short as possible.
- (3) The feedback path of voltage divider should be close to the FB pin and keep noisy traces away; also keep them separate using grounded copper.
- (4) The (+) plates of input capacitors should be close to the regulator.
- (5) Keep the (-) plates of input and output capacitors as close as possible.

Component Selection

1. Inductor Selection

The conduction mode of power stage depends on input voltage, output voltage, output current, and the value of the inductor. Select an inductor to maintain this device operating in continuous conduction mode (CCM). The minimum value of inductor can be determined by the following procedure.

- (1) Calculate the minimum duty ratio:

$$D_{(MIN)} = \frac{V_{OUT} + I_{LOAD} \times R_L + V_F}{V_{IN(MAX)} - I_{LOAD} \times R_{DS(ON)} + V_F} = \frac{T_{ON}}{T_S}$$

Where R_L is the DC resistance of external inductor, V_F is the forward voltage of external diode, and T_S is the switching period.

This formula can be simplified to

$$D_{(MIN)} = \frac{V_{OUT}}{V_{IN(MAX)}} = \frac{T_{ON}}{T_S} ; 0 \leq D \leq 1$$

- (2) Define a value of minimum current that is approximately 10%~30% of full load current to maintain continuous conduction mode, usually referred to as the critical current (I_{CRIT}).

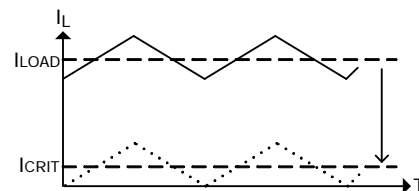

$$I_{CRIT} = \delta \times I_{LOAD} ; \delta = 0.1 \sim 0.3$$

- (3) Calculate the inductor ripple current (ΔI_L). In steady state conditions, the inductor ripple current increase, (ΔI_{L+}), during the ON time and the current decrease, (ΔI_{L-}), during the OFF time must be equal.

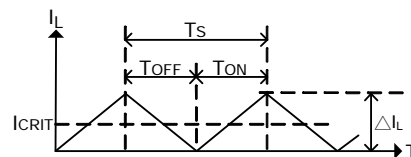

$$\Delta I_L = 2 \times I_{CRIT}$$

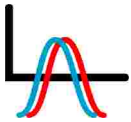

(4) Calculate the minimum value of inductor use maximum input voltage. That is the worst case condition because it gives the maximum ΔI_L .

$$L \geq \frac{[V_{IN(MAX)} - I_{LOAD} \times (R_{DS(ON)} + R_L) - V_{OUT}] \times D_{(MIN)}}{\Delta I_L \times f_s}$$

This formula can be simplified to

$$L \geq \frac{(V_{IN(MAX)} - V_{OUT}) \times D_{(MIN)}}{\Delta I_L \times f_s}$$

The higher value inductor results in lower output ripple current and ripple voltage. It also reduces the conduction loss. But higher value inductor requires larger physical size and price.

(5) Calculate the inductor peak current and choose a suitable inductor to prevent saturation.

$$I_{L(PEAK)} = I_{LOAD} + \frac{\Delta I_L}{2}$$

Coil inductors and surface mount inductors are all available. The surface mount inductors can reduce the board size but they are more expensive and its larger DC resistance results in more conduction loss. The power dissipation is due to the DC resistance can be calculated as below:

$$P_{D_INDUCTOR} = I_{LOAD}^2 \times R_L$$

2. Output Rectifier Diode Selection

The rectifier diode provides a current path for the inductor current when the internal power switch of the converter turns off. The best solution is Schottky diode, and some parameters about the diode must be take care as below:

- (1) The forward current rating of diode must be higher than the continuous output current.
- (2) The reverse voltage rating of diode must be higher than the maximum input voltage.
- (3) The lower forward voltage of diode will reduce the conduction loss.
- (4) The faster reverse recovery time of diode will reduce the switching loss, but it is very small compared to conduction loss.
- (5) The power dissipation can be calculated by the forward voltage and output current for the time that the diode is conducting.

$$P_{D_DIODE} = I_{LOAD} \times V_F \times (1 - D)$$

3. Output Capacitor Selection

The functions of the output capacitor are to store energy and maintain the output voltage. The low ESR (Equivalent Series Resistance) capacitors are preferred to reduce the output ripple voltage (ΔV_{OUT}) and conduction loss. The output ripple voltage can be calculated as below:

$$\Delta V_{OUT} = \Delta I_L \times (ESR_{_COUT} + \frac{1}{8 \times f_s \times C_{OUT}})$$

(1) When low ESR ceramic capacitor is used as output capacitor, the output ripple voltage due to the ESR can be ignored results in all the output ripple voltage is due to the capacitance. Choose suitable capacitors must define the expectative value of output ripple voltage first.

The minimum capacitance can be determined by the switching frequency, the output ripple current, and the expectative output ripple voltage. The above formula can be simplified to:

$$C_{OUT(MIN)} \geq \frac{\Delta I_L}{8 \times f_s \times \Delta V_{OUT}}$$

Besides, the compensation components must be used to stabilize the control loop in some applications, such as using a 1nF ceramic capacitor across the high side resistor of the output voltage divider.

(2) The ESR of the aluminum electrolytic or tantalum output capacitor is an important parameter to determine the output ripple voltage. But the manufacturers usually do not specify ESR in the specifications. Assuming the capacitance is enough results in the output ripple voltage is due to the capacitance can be ignored, the ESR should be limited to achieve the expectative output ripple voltage. The maximum ESR can be calculated as below:

$$ESR_{_COUT} \leq \frac{\Delta V_{OUT}}{\Delta I_L}$$

Choose the output capacitance by the average value of the RC product as below:

$$C_{OUT} \approx \frac{50 \sim 80 \times 10^{-6}}{ESR_{_COUT}}$$

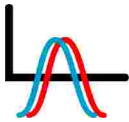

(3) The ESR and the ripple current results in power dissipation in the capacitor. It will increase the internal temperature. Usually, the capacitors' manufacturers specify ripple current ratings and should not be exceeded to prevent excessive temperature shorten the life time. Choose a smaller inductor causes higher ripple current which maybe result in the capacitor overstress. The RMS ripple current flowing through the output capacitor and power dissipation can be calculated as below:

$$I_{RMS_COUT} = \frac{\Delta I_L}{\sqrt{12}} = \Delta I_L \times 0.289$$

$$P_{D_COUT} = (I_{RMS_COUT})^2 \times ESR_COUT$$

(4) Besides, the capacitor's ESL (Equivalent Series Inductance) maybe causes ringing in the low MHz region. Choose low ESL capacitors, limiting lead length of PCB and capacitor, and parallel connecting several smaller capacitors to replace with a larger one will reduce the ringing phenomenon.

4. Input Capacitor Selection

The input capacitor is required to supply current to the regulator and maintain the DC input voltage. Low ESR capacitors are preferred those provide the better performance and the less ripple voltage.

(1) The input capacitors need an adequate RMS current rating. It can be calculated by following formula and should not be exceeded.

$$I_{RMS_CIN} = I_{LOAD(MAX)} \times \sqrt{D \times (1 - D)}$$

This formula has a maximum at $V_{IN}=2V_{OUT}$. That is the worst case and the above formula can be simplified to:

$$I_{RMS_CIN} = \frac{I_{LOAD(MAX)}}{2}$$

Therefore, choose a suitable capacitor at input whose ripple current rating must greater than half of the maximum load current.

(2) The input ripple voltage (ΔV_{IN}) mainly depends on the input capacitor's ESR and its capacitance. Assuming the input current of the regulator is constant, the required input capacitance for a given input ripple voltage can be calculated as below:

$$C_{IN} = \frac{I_{LOAD(MAX)} \times D \times (1 - D)}{f_S \times (\Delta V_{IN} - I_{LOAD(MAX)} \times ESR_CIN)}$$

If using aluminum electrolytic or tantalum input capacitors, parallel connecting a 0.1uF ceramic capacitor as close to the IN pin of regulator as possible. If using ceramic capacitor, make sure the capacitance is enough to prevent the excessive input ripple current.

(3) The power dissipation of input capacitor causes a small conduction loss can be calculated as below:

$$P_{D_CIN} = (I_{RMS_CIN})^2 \times ESR_CIN$$

✓ Quick Design Table

For 4A output current, $\Delta I_L=0.8A$, continuous mode operation

A: Inductor value

B: High side resistor of the output voltage divider

C: Low side resistor of the output voltage divider

D: Peak current setting resistor (R_{OCSET})

$V_{OUT} \backslash V_{IN}$	5V	9V	12V	18V
0.8V	A: 3.9uH B: 0 Ohm C: NC D: 3.3KOhm			
1.2V	A: 4.7uH B: 1.5KOhm C: 3KOhm D: 3.3KOhm			
1.5V	A: 6.8uH B: 1.3KOhm C: 1.5KOhm D: 3.3KOhm	A: 6.8uH B: 1.3KOhm C: 1.5KOhm D: 2.7KOhm		
1.8V	A: 6.8uH B: 2.5KOhm C: 2KOhm D: 3.3KOhm	A: 12uH B: 2.5KOhm C: 2KOhm D: 2.7KOhm		
2.5V	A: 6.8uH B: 4.7KOhm C: 2.2KOhm D: 3.3KOhm	A: 10uH B: 4.7KOhm C: 2.2KOhm D: 2.7KOhm	A: 12uH B: 4.7KOhm C: 2.2KOhm D: 2.2KOhm	
3.3V	A: 6.8uH B: 4.7KOhm C: 1.5KOhm D: 3.3KOhm	A: 12uH B: 4.7KOhm C: 1.5KOhm D: 2.7KOhm	A: 15uH B: 4.7KOhm C: 1.5KOhm D: 2.2KOhm	A: 15uH B: 4.7KOhm C: 1.5KOhm D: 2.7KOhm
5V		A: 12uH B: 6.8KOhm C: 1.3KOhm D: 2.7KOhm	A: 18uH B: 6.8KOhm C: 1.3KOhm D: 2.2KOhm	A: 22uH B: 6.8KOhm C: 1.3KOhm D: 2.7KOhm
9V			A: 12uH B: 10.2KOhm C: 1KOhm D: 2.2KOhm	A: 27uH B: 10.2KOhm C: 1KOhm D: 2.7KOhm
12V				A: 22uH B: 18.2KOhm C: 1.3KOhm D: 2.7KOhm

▼ Evaluation Board Layout

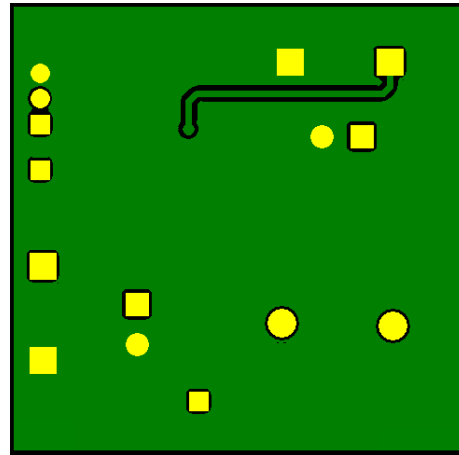
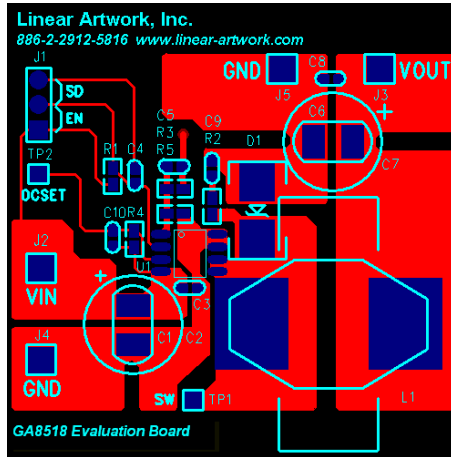

▼ Evaluation Board Schematic

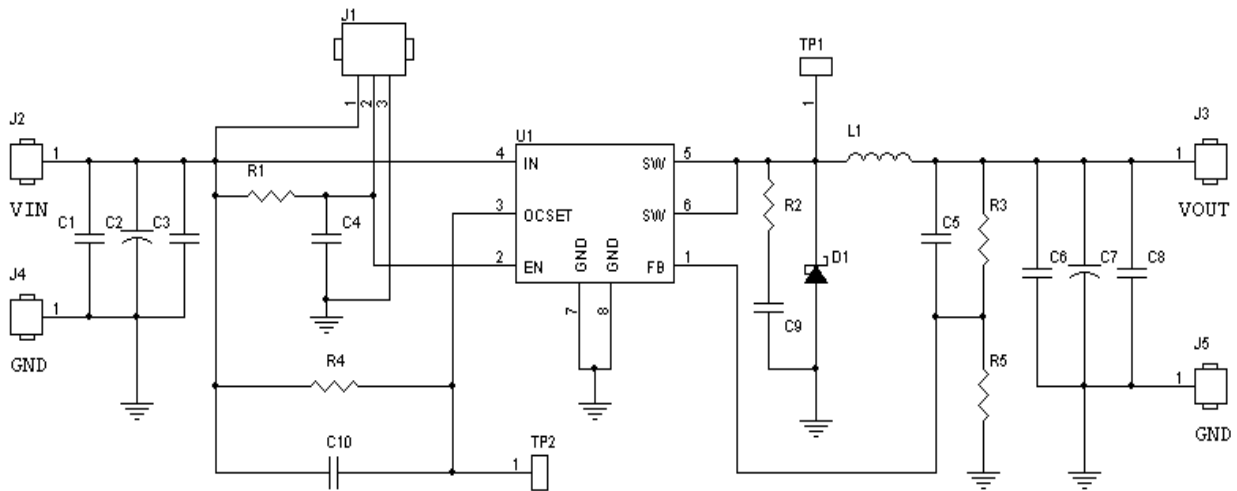

√ Bill of Materials
 $V_{IN}=12V, V_{OUT}=3.3V, I_{OUT}=4A$

Designation	Descriptions	Manufacturer Part #	Manufacturer	Manufacturer Website
U1	300KHz, 4A Step-Down DC-DC Converter SOP-8L Package	GA8518JGADJ	Linear Artwork	www.linear-artwork.com
L1	Surface Mount Inductor 15uH 8A 0.036Ohm	SSL1306T-150M-N	Chilisin	www.chilisin.com.tw
	Choke 15uH 7.2A 0.015Ohm	TDH1420T-150K-N	Chilisin	www.chilisin.com.tw
D1	Schottky Diode 40V 5A 0.55V _F , SMC Package	SK54C	TSC	www.taiwansemi.com
C2,C7	Low ESR E/C 330uF, 25V, 8x15mm	EKY-250EXX331MH15D	NCC	www.chemi-con.co.jp
C3,C8	MLCC 0.1uF, 0805, X7R, 50V	CC0805KRX7R9BB104	Yageo	www.yageo.com
	MLCC 0.1uF, 0805, X7R, 50V	UMK212BJ104KG	Taiyo Yuden	www.yuden.co.jp
	MLCC 0.1uF, 0603, B, 50V	C1608JB1H104K	TDK	www.tdk.com
C4,C5,C9, C10	Optional Parts			
C1,C6	No Connection			
R3	Chip Resistor, 4.7KOhm, 0805, ±1%	RC0805FR-074K7L	Yageo	www.yageo.com
R4	Chip Resistor, 2.2KOhm, 0805, ±1%	RC0805FR-072K2L	Yageo	www.yageo.com
R5	Chip Resistor, 1.5KOhm, 0805, ±1%	RC0805FR-071K5L	Yageo	www.yageo.com
R1,R2	Optional Parts			
J1	Male Header 180° 3*1P 2.54mm			
J2,J3,J4,J5	Terminal Binding Post 1.6mm			
TP1,TP2	Male Header 180° 1P 2.54mm			

▼ Typical Application Circuits

◆ 12V->9V Application Circuit

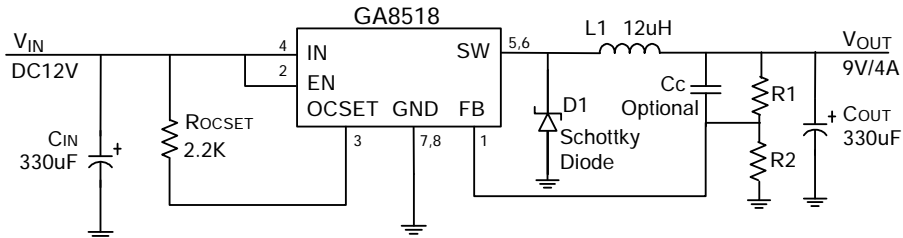

$$V_{OUT} = V_{FB} \times (1 + R1 / R2); \quad R1=10.2K\Omega, R2=1K\Omega$$

◆ 12V->5V With ON/OFF Control Circuit

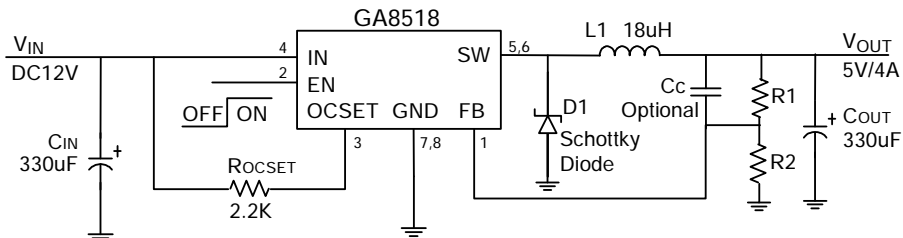

$$R1=6.8K\Omega, R2=1.3K\Omega$$

◆ 12V->3.3V With Delay Start-up Circuit

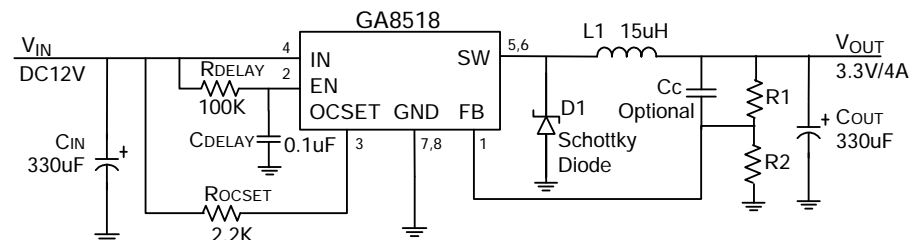

$$R1=4.7K\Omega, R2=1.5K\Omega, T_{DELAY} \approx 1.147mS$$

◆ 5V->1.8V Application Circuit

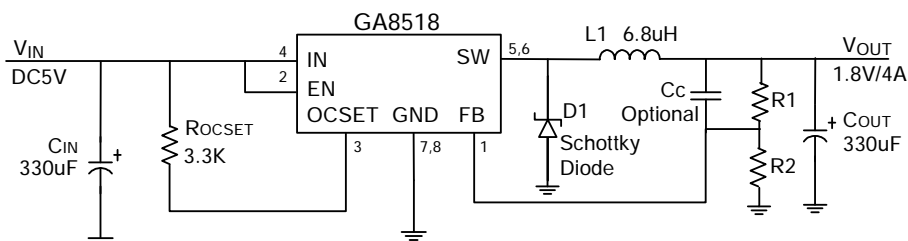

$$R1=2.5K\Omega, R2=2K\Omega$$

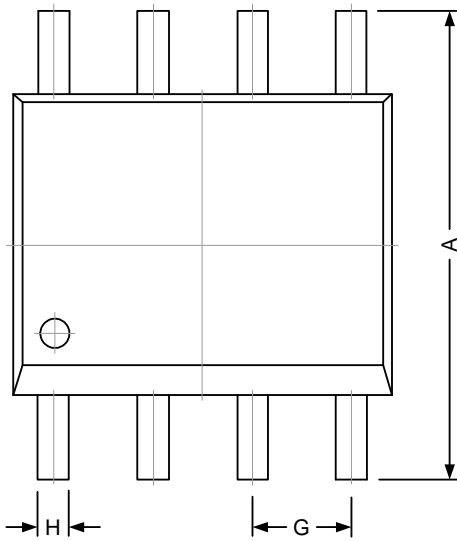
▼ Package Outline
SOP-8L

REF.	DIMENSIONS	
	Millimeter	
	Min.	Max.
A	5.80	6.20
B	4.80	5.00
C	3.80	4.00
D	0°	8°
E	0.40	0.90
F	0.19	0.25
M	0.10	0.25
H	0.35	0.49
L	1.35	1.75
J	0.375 REF.	
K	45°	
G	1.27 TYP.	

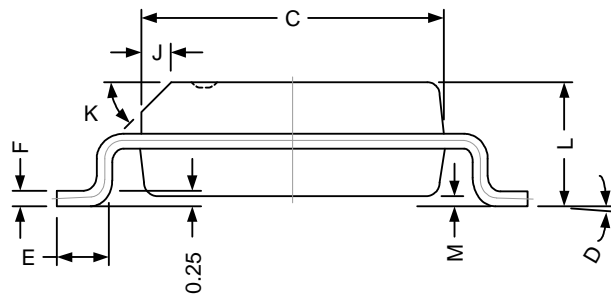
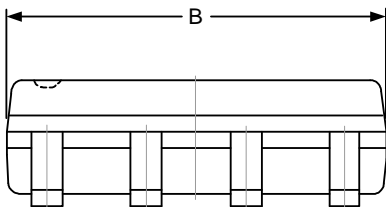

NOTICE

The specifications and product information of Linear Artwork, Inc. are subject to change without any prior notice, and customer should contact Linear Artwork, Inc. to obtain the latest relevant information before placing orders and verify that such information is current and complete.

The information provided here is believed to be reliable and accurate; however Linear Artwork, Inc. makes no guarantee for any errors that appear in this document.

LIFE SUPPORT POLICY

Linear Artwork products are not designed or authorized for use as critical components in life support devices or systems without the express written approval of the president of Linear Artwork, Inc. As used herein:

1. Life support devices or systems are devices or systems which, (a) are intended for surgical implant into the body, or (b) support or sustain life, and (c) whose failure to perform when properly used in accordance with instructions for use provided in the labeling, can be reasonably expected to result in a significant injury of the user.
2. A critical component in any component of a life support device or system whose failure to perform can be reasonably expected to cause the failure of the life support device or system, or to affect its safety or effectiveness.

Linear Artwork, Inc.**Headquarter**

6F-1, No.293, Sec.1, Beisin Road, Sindian City, Taipei Country 231, Taiwan (R.O.C.)

TEL : +886-2-2912-5816

FAX : +886-2-2912-5826

Website : www.linear-artwork.com

E-mail : sales@linear-artwork.com