

目 录

交流单相通用滤波器.....	2
交流单相高性能滤波器.....	4
交流单相超高性能滤波器.....	6
交流三相三线滤波器.....	8
交流三相四线滤波器.....	10
变频器专用型滤波器.....	12
直流滤波器.....	14
PCB 插针型 & IEC 标准插座形滤波器.....	16
军用交流单相高性能滤波器.....	18
军用交流三相滤波器.....	20
军用直流滤波器.....	22
屏蔽室电源滤波器双线系列.....	24
屏蔽室电源滤波器单线系列.....	26
滤波器外形尺寸版.....	28
滤波器基础知识介绍.....	31



交流单相通用滤波器 General Purpose Filters



产品特点

- ▲ 对差模和共模干扰具有良好的抑制特性。
- ▲ 泄漏电流小。
- ▲ 体积小，重量轻，性能可靠、价格低廉。

Features

- ▲ General purpose filters with a good suppression to common-mode and differential-mode interference.
- ▲ Lower leakage current.
- ▲ Compact, light weight, reliable and low cost

技术指标

- ▲ 额定电压: 115/250VAC
- ▲ 工作频率: 50/60Hz
- ▲ 泄漏电流: < 0.5 mA (250VAC/50Hz)
- ▲ 测试电压: 线—线: 1450VDC, 一分钟。 线—地: 1500VAC, 一分钟。
- ▲ 温度范围: -25℃~+85℃

Specification

- ▲ Rated Voltage: 115/250VAC
- ▲ Line Frequency: 50/60Hz
- ▲ Leakage Current: <0.5 mA(250VAC/50Hz)
- ▲ Test Voltage: Line—Line: 1450VDC, 1 min. Line—Ground: 1500VAC, 1 min.
- ▲ Temperature Range: -25℃~+85℃

应用场合

开关电源、UPS 电源、医疗设备、仪器仪表等电力电子设备。

Application

Switching-mode power supply, UPS, medical equipments and electronic instruments etc.

电路原理图Electrical Schematics

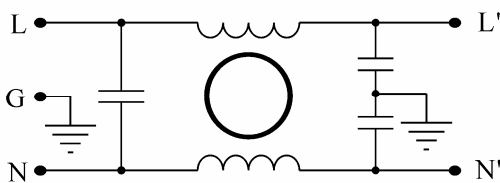

【 A 】

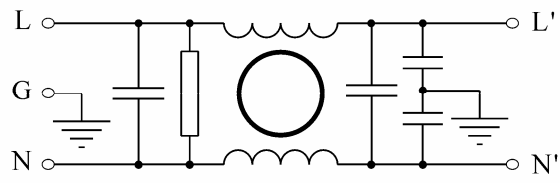

【 B 】

交流单相通用滤波器参数表 General Purpose Filter Parameter

型号	额定 电流 (A)	外形 尺寸 图号	原理 电路 图号				插入损耗 (dB) 共模/差模 (CM/DM)									
				06	07	08	测试频率(MHz)									
							0.01	0.05	0.10	0.15	0.5	1.0	5.0	10	20	30
F-FAB1-03-??	3	B1	A			08	11/5	23/10	29/15	32/19	37/29	41/36	49/53	52/55	55/54	50/52
F-FAB1-06-??	6	B1	A			08	5/4	13/9	19/15	22/18	31/28	35/33	49/55	52/57	56/56	58/52
F-FAB2-03-??	3	B2	A			08	11/5	23/10	29/15	32/19	37/29	41/36	49/53	52/55	55/54	50/52
F-FAB2-06-??	6	B2	A			08	5/4	13/9	19/15	22/18	31/28	35/33	49/55	52/57	56/56	58/52
F-LAB1-02-??	2	B1	A			08	21/7	28/15	30/20	31/21	36/53	42/53	57/63	69/69	62/68	62/68
F-LAB1-03-??	3	B1	A			08	18/6	25/15	27/19	29/21	33/48	39/50	53/63	63/69	69/65	68/68
F-LAB2-02-??	2	B2	A			08	21/7	28/15	30/20	31/21	36/53	42/53	57/63	69/69	62/68	62/68
F-LAB2-03-??	3	B2	A			08	18/6	25/15	27/19	29/21	33/48	39/50	53/63	63/69	69/65	68/68
F-FAC1-03-??	3	C1	A		07	08	16/6	29/11	35/16	39/19	45/31	47/43	52/51	53/55	52/56	52/56
F-FAC1-06-??	6	C1	A		07	08	5/4	13/9	19/15	22/18	31/28	35/33	49/55	52/57	56/56	58/52
F-FAC2-03-??	3	C2	A		07	08	16/6	29/11	35/16	39/19	45/31	47/43	52/51	53/55	52/56	52/56
F-FAC2-06-??	6	C2	A		07	08	5/4	13/9	19/15	22/18	31/28	35/33	49/55	52/57	56/56	58/52
F-LAC1-03-??	3	C1	A		07	08	26/6	37/10	38/16	41/19	45/30	50/40	57/63	60/60	58/60	55/62
F-LAC1-06-??	6	C1	A		07	08	20/6	30/11	32/16	34/19	38/29	42/36	46/55	50/53	52/54	52/58
F-LAC2-03-??	3	C2	A		07	08	26/6	37/10	38/16	41/19	45/30	50/40	57/63	60/60	58/60	55/62
F-LAC2-06-??	6	C2	A		07	08	20/6	30/11	32/16	34/19	38/29	42/36	46/55	50/53	52/54	52/58
F-FBD1-06-??	6	D1	B	06	07		11/7	23/18	30/21	32/22	37/50	42/53	53/63	53/63	68/65	62/68
F-FBD1-10-??	10	D1	B	06	07		4/5	16/17	22/21	24/25	30/44	34/47	46/53	53/63	68/65	62/64
F-FBD2-06-??	6	D2	B	06	07		11/7	23/18	30/21	32/22	37/50	42/53	53/63	53/63	68/65	62/68
F-FBD2-10-??	10	D2	B	06	07		4/5	16/17	22/21	24/25	30/44	34/47	46/53	53/63	68/65	62/64
F-LBD1-06-??	6	D1	B	06	07		21/8	33/18	36/24	38/25	42/56	47/58	59/69	59/63	68/60	62/65
F-LBD1-10-??	10	D1	B	06	07		20/8	25/19	28/24	29/25	33/47	38/50	53/59	57/63	62/63	62/65
F-LBE2-15-??	15	E2	B	06	07		20/8	25/19	28/24	29/25	33/47	38/50	53/59	57/63	62/63	62/65
F-LBE2-20-??	20	E2	B	06	07		20/8	25/19	28/24	29/25	33/47	38/50	53/59	57/63	62/63	62/65
F-FBE2-30-??	30	E2	B	06	07		3/8	13/20	18/25	20/25	25/35	28/37	40/45	43/51	50/53	62/66
F-LBE2-30-??	30	E2	B	06	07		10/8	15/19	18/20	20/31	23/42	30/43	50/57	57/63	68/68	70/70
F-FBF2-40-??	40	F2	B	06			3/8	13/20	18/25	20/25	25/35	28/37	40/45	43/51	50/53	62/66
F-LBF2-40-??	40	F2	B	06			10/8	15/19	18/20	20/31	23/42	30/43	50/57	57/63	68/68	70/70
F-FBG2-60-??	60	G2	B	06			3/8	13/20	18/25	20/25	25/35	28/37	40/45	43/51	50/53	62/66
F-LBG2-60-??	60	G2	B	06			10/8	15/19	18/20	20/31	23/42	30/43	50/57	57/63	68/68	70/70
F-FBH2-100-??	100	H2	B	06			3/8	13/20	18/25	20/25	25/35	28/37	40/45	43/51	50/53	62/66
F-LBH2-100-??	100	H2	B	06			10/8	15/19	18/20	20/31	23/42	30/43	50/57	57/63	68/68	70/70
F-FBH2-150-??	150	H2	B	06			3/8	13/20	18/25	20/25	25/35	28/37	40/45	43/51	50/53	62/66
F-LBH2-150-??	150	H2	B	06			10/8	15/19	18/20	20/31	23/42	30/43	50/57	57/63	68/68	70/70
F-LBZ2-300-??	300	Z2	B	06			10/8	15/19	18/20	20/31	23/42	30/43	50/57	57/63	68/68	70/70
F-LBP1-10-??	10	P1	B	06	07		23/8	28/19	30/22	31/24	36/50	41/60	60/64	63/69	68/70	68/68
F-LBP1-20-??	20	P1	B	06	07		18/8	25/18	26/23	28/26	32/47	38/50	53/63	60/68	68/70	62/62
F-FAM1-03-??	3	M1	A	06	07	08	11/5	23/10	29/15	32/19	37/29	41/36	49/53	52/55	55/54	50/52

外形尺寸详见外形版

交流单相高性能滤波器 High Performance Filters



产品特点

- ▲ 双级共模、一级共模一级差模滤波电路，具有良好的共模和差模干扰抑制特性。
- ▲ 能有效抑制各种高频瞬态干扰。

Features

- ▲ The filters of two CM sections, one CM plus one DM sections or two CM plus one DM sections can provide good performance in suppressing both CM and DM noises.
- ▲ Effective suppression to high frequency transient interference

技术指标

- ▲ 额定电压: 115/250VAC
- ▲ 工作频率: 50/60Hz
- ▲ 泄漏电流: <1.0 mA(250VAC/50Hz)
- ▲ 测试电压: 线—线: 1450VDC, 一分钟。 线—地 : 1500VAC, 一分钟。
- ▲ 温度范围: -25°C ~ +85°C

Specification

- ▲ Rated Voltage: 115/250VAC
- ▲ Line Frequency: 50/60Hz
- ▲ Leakage Current:<1.0 mA(250VAC/50Hz)
- ▲ Test Voltage: Line—Line 1450VDC, 1 min. Line—Ground 1500VAC, 1 min.
- ▲ Temperature Range: -25°C ~ +85°C

应用场合

适用于要求满足 FCC B 级、VDE0871 电磁兼容标准要求的电力电子设备。



Application

Suited for power and electronic equipments which must meet the EMC requirements of FCC Class Band VDE0871.

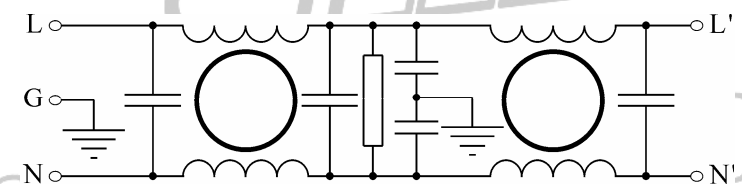
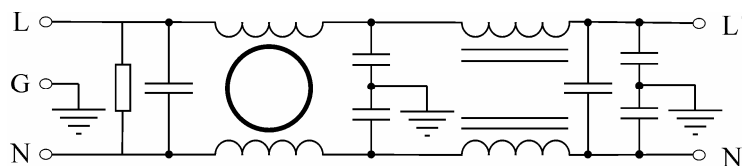
电路原理图Electrical Schematics



交流单相高性能滤波器参数表 High Performance Filter Parameter List

型号	额定 电流 (A)	外形 尺寸 图号	原理 电路 图号				插入损耗 (dB) 共模/差模 (CM/DM)									
							测试频率(MHz)									
							0.01	0.05	0.10	0.15	0.5	1.0	5.0	10	20	30
F-FDB1-01-??	1	B1	D			08	18/7	23/18	45/22	55/25	70/68	74/74	74/74	72/72	70/70	68/68
F-FDB1-02-??	2	B1	D			08	14/5	19/16	38/21	48/22	68/55	72/70	74/74	72/72	70/70	68/68
F-FDB1-03-??	3	B1	D			08	10/7	18/16	25/22	35/24	54/29	64/70	74/74	74/74	72/75	70/72
F-FDB2-01-??	1	B2	D			08	18/7	23/18	45/22	55/25	70/68	74/74	74/74	72/72	70/70	68/68
F-FDB2-02-??	2	B2	D			08	14/5	19/16	38/21	48/22	68/55	72/70	74/74	72/72	70/70	68/68
F-FDB2-03-??	3	B2	D			08	10/7	18/16	25/22	35/24	54/29	64/70	74/74	74/74	72/75	70/72
F-FCB1-01-??	1	B1	C			08	18/8	31/38	37/53	39/51	63/63	71/63	63/63	65/63	70/59	76/62
F-FCB1-03-??	3	B1	C			08	13/8	24/37	27/40	27/39	39/49	59/63	65/57	63/54	62/53	62/56
F-FCB2-01-??	1	B2	C			08	18/8	31/38	37/53	39/51	63/63	71/63	63/63	65/63	70/59	76/62
F-FCB2-03-??	3	B2	C			08	13/8	24/37	27/40	27/39	39/49	59/63	65/57	63/54	62/53	62/56
F-FDC1-03-??	3	C1	D		07	08	15/6	17/18	38/20	48/21	68/56	74/60	74/68	70/70	68/70	66/68
F-FDC1-06-??	6	C1	D		07	08	8/6	16/16	26/19	29/20	37/42	48/60	70/71	72/70	65/65	60/62
F-FDC2-03-??	3	C2	D			08	15/6	17/18	38/20	48/21	68/56	74/60	74/68	70/70	68/70	66/68
F-FDC2-06-??	6	C2	D			08	8/6	16/16	26/19	29/20	37/42	48/60	70/71	72/70	65/65	60/62
F-FCC1-03-??	3	C1	C		07	08	18/8	31/38	37/53	39/51	63/63	71/63	63/63	65/63	70/59	76/62
F-FCC1-06-??	6	C1	C		07	08	13/8	24/37	27/40	27/39	39/49	59/63	65/57	63/54	62/53	62/56
F-FCC2-03-??	3	C2	C			08	18/8	31/38	37/53	39/51	63/63	71/63	63/63	65/63	70/59	76/62
F-FCC2-06-??	6	C2	C			08	13/8	24/37	27/40	27/39	39/49	59/63	65/57	63/54	62/53	62/56
F-FCD1-06-??	6	D1	C	06	07		18/8	31/38	37/53	39/51	63/63	71/63	63/63	65/63	70/59	76/62
F-FCD1-10-??	10	D1	C	06	07		13/8	24/37	27/40	27/39	39/49	59/63	65/57	63/54	62/53	62/56
F-FCD2-06-??	6	D2	C	06	07		18/8	31/38	37/53	39/51	63/63	71/63	63/63	65/63	70/59	76/62
F-FCD2-10-??	10	D2	C	06	07		13/8	24/37	27/40	27/39	39/49	59/63	65/57	63/54	62/53	62/56
F-FDE2-20-??	20	E2	D	06	07		8/7	15/14	26/21	41/17	71/53	73/68	71/68	75/70	68/59	59/51
F-FCE2-15-??	15	E2	C	06	07		18/8	31/38	37/53	39/51	63/63	71/63	63/63	65/63	70/59	76/62
F-FCE2-20-??	20	E2	C	06	07		13/8	24/37	27/40	27/39	39/49	59/63	65/57	63/54	62/53	62/56
F-FDF2-30-??	30	F2	D	06			3/7	13/19	15/22	22/30	50/62	56/62	64/70	63/67	60/62	58/60
F-FDG2-30-??	30	G2	D	06			6/8	15/28	18/29	33/46	57/63	74/70	74/73	70/72	63/66	60/64
F-FDG2-50-??	50	G2	D	06			4/10	10/19	14/21	25/30	50/62	60/73	63/73	69/69	62/64	60/62
F-FCG2-30-??	30	G2	C	06			18/8	31/38	37/53	39/51	63/63	71/63	63/63	65/63	70/59	76/62
F-FCG2-50-??	50	G2	C	06			13/8	24/37	27/40	27/39	39/49	59/63	65/57	63/54	62/53	62/56
F-FDH2-60-??	60	H2	D	06			10/17	17/21	45/57	57/65	77/67	77/77	71/77	78/78	70/67	70/70
F-FDH2-100-??	100	H2	D	06			6/9	9/18	33/34	49/63	71/77	77/77	77/77	78/78	76/76	70/76
F-FCH2-60-??	60	H2	C	06			18/8	31/38	37/53	39/51	63/63	71/63	63/63	65/63	70/59	76/62
F-FCH2-100-??	100	H2	C	06			13/8	24/37	27/40	27/39	39/49	59/63	65/57	63/54	62/53	62/56
F-FDP1-06-??	6	P1	D	06	07		19/8	28/15	50/16	62/19	74/70	74/74	69/70	60/69	62/62	56/56
F-FDP1-10-??	10	P1	D	06	07		10/9	17/20	25/26	39/28	59/59	68/74	70/74	63/70	62/66	58/64
F-FDS1-20-??	20	S1	D	06	07		8/7	15/14	26/21	41/17	71/53	73/68	71/68	75/70	68/59	59/51

外形尺寸详见外形尺寸版

交流单相超高性能滤波器 High Performance Filters



产品特点

- ▲ 双级共模一级差模滤波电路，具有良好的共模和差模干扰抑制特性。
- ▲ 能有效抑制各种高频瞬态干扰。

Features

- ▲ The filters of two CM plus one DM sections or two CM plus one DM sections can provide good performance in suppressing both CM and DM noises.
- ▲ Effective suppression to high frequency transient interference.

技术指标

- ▲ 额定电压: 115/250VAC
- ▲ 工作频率: 50/60Hz
- ▲ 泄漏电流: <1.0 mA
- ▲ 测试电压: 线—线: 1450VDC, 一分钟。 线—地: 1500VAC, 一分钟。
- ▲ 温度范围: -25°C~+85°C

Specification

- ▲ Rated Voltage: 115/250VAC
- ▲ Line Frequency: 50/60Hz
- ▲ Leakage Current: <1.0 mA(250VAC/50Hz)
- ▲ Test Voltage: Line—Line 1450VDC, 1 min. Line—Ground 1500VAC, 1 min.
- ▲ Temperature Range: -25°C~+85°C

应用场合

适用于要求满足 FCC B 级、VDE0871 电磁兼容标准要求的电力电子设备。

Application

Suited for power and electronic equipments which must meet the EMC requirements of FCC Class Band VDE0871.

电路原理图 Electrical Schematics

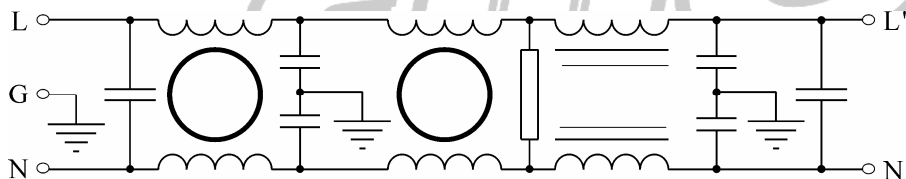

【 F 】

交流单相超高性能滤波器参数表 High Performance Filter Parameter List

型号	额定	外形	原理				插入损耗 (dB) 共模/差模 (CM/DM)									
	电流	尺寸	电路	06	07	08	测试频率(MHz)									
	(A)	图号	图号				0.01	0.05	0.10	0.15	0.5	1.0	5.0	10	20	30
F-FFB1-01-??	1	B1	F			08	18/7	20/13	44/36	53/46	67/67	66/67	63/63	63/57	70/53	64/56
F-FFB1-02-??	2	B1	F			08	18/7	20/13	44/36	53/46	67/67	66/67	63/63	63/57	70/53	64/56
F-FFB2-01-??	1	B2	F			08	18/7	20/13	44/36	53/46	67/67	66/67	63/63	63/57	70/53	64/56
F-FFB2-02-??	2	B2	F			08	18/7	20/13	44/36	53/46	67/67	66/67	63/63	63/57	70/53	64/56
F-FFC1-02-??	2	C1	F		07	08	14/10	15/15	41/35	54/47	76/76	76/76	77/77	77/77	70/66	66/68
F-FFC1-03-??	3	C1	F		07	08	11/6	18/14	30/33	41/43	63/71	71/71	71/63	68/57	61/53	70/52
F-FFC2-02-??	2	C2	F			08	14/10	15/15	41/35	54/47	76/76	76/76	77/77	77/77	70/66	66/68
F-FFC2-03-??	3	C2	F			08	11/6	18/14	30/33	41/43	63/71	71/71	71/63	68/57	61/53	70/52
F-FFD1-02-??	2	D1	F	06	07		16/10	21/21	45/41	56/53	76/76	76/76	77/77	77/77	68/72	68/66
F-FFD1-03-??	3	D1	F	06	07		14/10	15/15	41/35	54/47	76/76	76/76	77/77	77/77	70/66	66/68
F-FFD2-02-??	2	D2	F	06	07		16/10	21/21	45/41	56/53	76/76	76/76	77/77	77/77	68/72	68/66
F-FFD2-03-??	3	D2	F	06	07		14/10	15/15	41/35	54/47	76/76	76/76	77/77	77/77	70/66	66/68
F-LFD1-02-??	2	D1	F	06	07		21/15	26/26	48/44	58/55	76/76	76/76	77/77	77/77	68/72	68/66
F-LFD1-03-??	3	D1	F	06	07		18/14	20/20	44/40	56/49	76/76	76/76	77/77	77/77	70/66	66/68
F-LFD2-02-??	2	D2	F	06	07		21/15	26/26	48/44	58/55	76/76	76/76	77/77	77/77	68/72	68/66
F-LFD2-03-??	3	D2	F	06	07		18/14	20/20	44/40	56/49	76/76	76/76	77/77	77/77	70/66	66/68
F-FFE2-06-??	6	E2	F	06	07		17/6	23/14	50/36	56/48	70/70	68/70	70/72	70/72	74/74	68/68
F-FFE2-10-??	10	E2	F	06	07		6/8	15/28	18/29	33/45	57/68	70/74	70/72	65/65	63/66	60/66
F-LFE2-06-??	6	E2	F	06	07		21/15	26/26	48/44	58/55	76/76	76/76	77/77	77/77	68/72	68/66
F-LFE2-10-??	10	E2	F	06	07		18/14	20/20	44/40	56/49	76/76	76/76	77/77	77/77	70/66	66/68
F-FFF2-20-??	20	F2	F		07		6/8	15/28	18/29	33/46	57/63	74/70	74/73	70/72	63/66	60/64
F-LFF2-20-??	20	F2	F		07		16/8	19/13	25/25	37/39	62/68	74/74	74/74	73/72	72/68	68/70
F-FFG2-30-??	30	G2	F		07		17/9	20/14	26/26	37/39	62/68	74/74	74/74	73/72	72/70	68/70
F-LFG2-30-??	30	G2	F		07		22/16	27/27	50/48	58/55	76/76	76/76	77/77	77/77	68/72	68/66
F-FFS1-06-??	6	S1	F	06	07		17/6	23/14	50/36	56/48	70/70	68/70	70/72	70/72	74/74	68/68
F-FFS1-10-??	10	S1	F	06	07		6/8	15/28	18/29	33/45	57/68	70/74	70/72	65/65	63/66	60/66
F-LFS1-06-??	6	S1	F	06	07		23/16	27/20	54/36	56/48	70/70	68/70	70/72	70/72	74/74	70/70
F-LFS1-10-??	10	S1	F	06	07		16/12	19/28	25/29	33/45	57/68	70/74	70/72	68/69	68/69	66/69

外形尺寸详见外形尺寸版

交流三相三线 滤波器 Three phase Three Line Filters



产品特点

- ▲ 共模和差模电感均采用新型软磁材料。
- ▲ 泄漏电流小。
- ▲ 体积小，重量轻，低频性能好。

Features

- ▲ New type soft ferrites in CM and DM inductors.
- ▲ Lower leakage current.
- ▲ compact, light weight and good low frequency performance.

技术指标

- ▲ 额定电压: 440VAC
- ▲ 工作频率: 50/60Hz
- ▲ 泄漏电流: <2.0 mA(250VAC/50Hz)
- ▲ 测试电压: 线—线: 1450VDC, 一分钟. 线—地: 1500VAC, 一分钟
- ▲ 温度范围: -25°C ~ +85°C

Specification

- ▲ Rated Voltage: 440VAC
- ▲ Line Frequency: 50/60Hz
- ▲ Leakage Current: <2.0 mA(250VAC/50Hz)
- ▲ Test Voltage: Line—Line: 1450VDC, 1 min. Line—Ground: 1500VAC, 1 min.
- ▲ Temperature Range: -25°C ~ +85°C

应用场合

适用于需要三相供电的电力电子设备。如开关电源，UPS，通讯设备，医疗设备、变频器和电力驱动设备。

Application

Designed for 3-phase power supply systems and suited for Switching-mode power supply, UPS, communication system, medical equipments , inverters and power driving systems.

电路原理图 Electrical Schematics

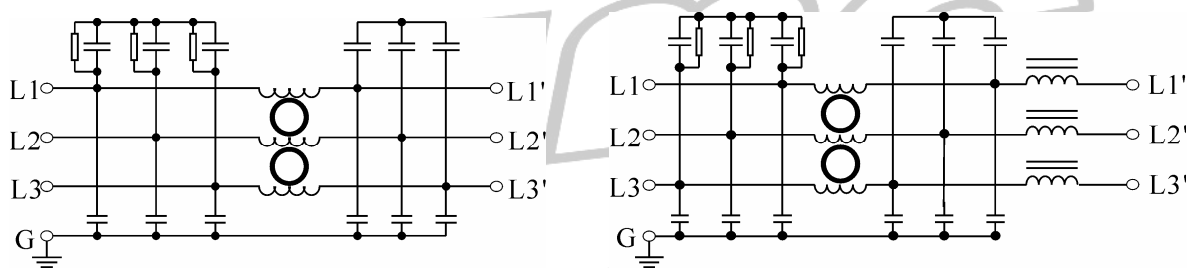



【 J 】

【 K 】

交流三相三线滤波器参数表

Three phase Three Line Filter parameter list

型号	额定 电流 (A)	外形 尺寸 图号	原理 电路 图号			插入损耗 (dB) 共模/差模 (CM/DM)									
						测试频率(MHz)									
						0.01	0.05	0.10	0.15	0.5	1.0	5.0	10	20	30
F-FJE3-06-??	6	E3	J	06	07	10/4	15/8	19/14	20/19	36/37	41/56	63/61	63/63	56/56	50/51
F-FJE3-10-??	10	E3	J	06	07	9/4	14/7	19/13	20/19	36/37	41/56	63/61	63/63	56/56	50/51
F-LJE3-06-??	6	E3	J	06	07	13/5	19/10	21/15	22/20	36/37	41/56	63/61	63/63	56/56	51/52
F-LJE3-10-??	10	E3	J	06	07	13/5	19/10	21/15	22/20	36/37	41/56	63/61	63/63	56/56	51/52
F-LKE3-06-??	6	E3	K	06	07	17/23	25/30	30/31	31/33	40/50	55/55	60/60	63/63	60/62	58/62
F-LKE3-10-??	10	E3	K	06	07	15/23	23/29	27/31	28/33	38/48	51/53	62/57	63/63	58/62	56/62
F-LKE3-15-??	15	E3	K	06	07	15/23	23/29	27/31	28/33	38/48	51/53	62/57	63/63	58/62	56/62
F-LJF3-20-??	20	F3	J	06		11/8	19/18	24/24	37/30	39/45	48/53	69/71	65/65	64/64	58/57
F-LKF3-20-??	20	F3	K	06		13/19	24/30	28/34	30/36	39/45	48/53	52/57	63/63	62/62	58/58
F-LJF3-30-??	30	F3	J	06		10/16	21/27	26/31	28/34	37/43	46/51	51/56	62/62	62/62	58/58
F-FJG3-50-??	50	G3	J	06		13/5	19/10	21/15	22/20	36/37	41/56	63/61	63/63	56/56	51/52
F-LJG3-50-??	50	G3	J	06		15/23	23/29	27/31	28/33	38/48	51/53	62/57	63/63	58/62	56/62
F-FJG3-60-??	60	G3	J	06		9/4	12/7	16/11	19/16	28/29	39/50	55/58	60/60	56/56	51/52
F-LJG3-60-??	60	G3	J	06		12/21	21/27	26/30	27/32	37/47	50/52	61/57	63/63	58/62	56/62
F-LKG3-40-??	40	G3	K	06		16/11	24/23	31/24	34/30	39/47	61/64	74/74	74/74	72/72	68/68
F-LKG3-50-??	50	G3	K	06		9/15	17/26	19/31	20/31	28/37	37/42	61/57	64/70	63/75	60/60
F-LKG3-60-??	60	G3	K	06		9/15	17/26	19/31	20/31	28/37	37/42	61/57	64/70	63/75	60/60
F-LKH3-40-??	40	H3	K	06		11/17	16/22	19/25	22/27	40/42	55/55	76/76	76/76	63/63	68/66
F-LKH3-50-??	50	H3	K	06		11/17	16/22	19/25	22/27	40/42	55/55	76/76	76/76	63/63	68/66
F-LKH3-60-??	60	H3	K	06		9/15	14/20	17/23	22/27	40/42	55/55	76/76	76/76	63/63	68/66
F-LKH3-80-??	80	H3	K	06		7/10	12/18	15/20	20/24	37/39	53/53	74/74	74/74	63/63	68/66
F-LJH3-80-??	80	H3	J	06		11/8	19/18	24/24	37/30	39/45	48/53	69/71	65/65	64/64	58/57
F-LJH3-100-??	100	H3	J	06		11/5	19/10	21/15	22/20	36/37	41/56	63/61	63/63	56/56	51/52
F-LKZ3-100-?	100	Z3	K	06		16/11	24/23	31/24	34/30	39/47	61/64	74/74	74/74	72/72	68/68
F-LKZ3-200-?	200	Z3	K	06		10/4	15/8	19/14	20/19	36/37	41/56	63/61	63/63	56/56	50/51
F-LJZ3-300-??	300	Z3	J	06		9/9	14/24	16/28	17/33	25/35	35/33	57/55	60/63	54/36	29/33

外形尺寸详见外形尺寸版

交流三相四线滤波器 Three phase Four Line Filters



产品特点

- ▲ 共模和差模电感均采用新型软磁材料。
- ▲ 泄漏电流小。
- ▲ 体积小，重量轻，低频性能好。

Features

- ▲ New type soft ferrites in CM and DM inductors.
- ▲ Lower leakage current.
- ▲ compact, light weight and good low frequency performance.

技术指标

- ▲ 额定电压: 440VAC
- ▲ 工作频率: 50/60Hz
- ▲ 泄漏电流: <2.0 mA(250VAC/50Hz)
- ▲ 测试电压: 线—线: 1450VDC, 一分钟. 线—地: 1500VAC, 一分钟
- ▲ 温度范围: -25°C~+85°C

Specification

- ▲ Rated Voltage: 440VAC
- ▲ Line Frequency: 50/60Hz
- ▲ Leakage Current: <2.0 mA(250VAC/50Hz)
- ▲ Test Voltage: Line—Line: 1450VDC, 1 min. Line—Ground: 1500VAC, 1 min.
- ▲ Temperature Range: -25°C~+85°C

应用场合

适用于需要三相供电的电力电子设备。如开关电源，UPS，通讯设备，医疗设备、变频器和电力驱动设备。



Application

Designed for 3-phase power supply systems and suited for Switching-mode power supply, UPS, communication system, medical equipments, inverters and power driving systems.

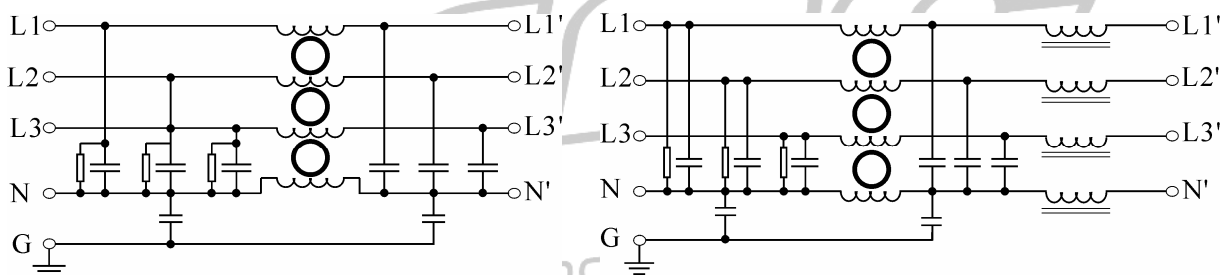
电路原理图 Electrical Schematic



交流三相四线滤波器参数表
Three phase Four Line Filter Parameter List

型号	额定 电流 (A)	外形 尺寸 图号	原理 电路 图号	 06  07	插入损耗 (dB) 共模/差模 (CM/DM)										
					测试频率(MHz)										
					0.01	0.05	0.10	0.15	0.5	1.0	5.0	10	20	30	
F-LME4-06-??	6	E4	M	06	07	16/5	21/10	23/15	25/26	38/40	45/53	69/69	60/57	56/56	52/52
F-LME4-10-??	10	E4	M	06	07	13/5	19/10	21/15	22/20	36/37	41/56	63/61	63/63	56/56	51/52
F-LME4-15-??	15	E4	M	06	07	13/5	19/10	21/15	22/20	36/37	41/56	63/61	63/63	56/56	51/52
F-LMF4-20-??	20	F4	M	06		9/8	19/19	21/24	23/28	36/40	47/53	77/73	63/63	62/58	56/56
F-LMF4-30-??	30	F4	M	06		7/6	17/17	19/22	23/28	36/40	47/53	77/73	63/63	62/58	56/56
F-LMG4-40-??	40	G4	M	06		9/15	17/26	19/31	20/31	28/37	37/42	61/57	64/70	63/75	60/60
F-LRG4-40-??	40	G4	R	06		10/14	14/24	15/27	19/30	25/34	35/39	60/60	71/71	76/76	72/72
F-LMG4-50-??	50	G4	M	06		8/13	12/18	14/19	15/20	22/26	30/30	62/60	76/76	65/65	60/63
F-LMH4-80-??	80	H4	M	06		14/18	18/28	20/31	22/32	25/34	35/39	60/60	71/71	76/76	72/72
F-LMH4-100-??	100	H4	M	06		10/14	14/24	15/27	1/1	25/34	35/39	60/60	71/71	76/76	72/72
F-LRH4-40-??	40	H4	R	06		8/13	12/18	14/19	15/20	22/26	30/30	62/60	76/76	65/65	60/63
F-LRH4-50-??	50	H4	R	06		8/13	12/18	14/19	15/20	22/26	30/30	62/60	76/76	65/65	60/63
F-LRZ4-100-??	100	Z4	R	06		16/11	24/23	31/24	34/30	39/47	61/64	74/74	74/74	72/72	68/68
F-LRZ4-200-??	200	Z4	R	06		9/9	14/24	16/28	17/33	25/35	35/33	57/55	60/63	54/36	29/33
F-LRZ4-300-??	300	Z4	R	06		9/9	14/24	16/28	17/33	25/35	35/33	57/55	60/63	54/36	29/33

外形尺寸详见外形尺寸版

变频器专用型滤波器 The Filters For Inverters

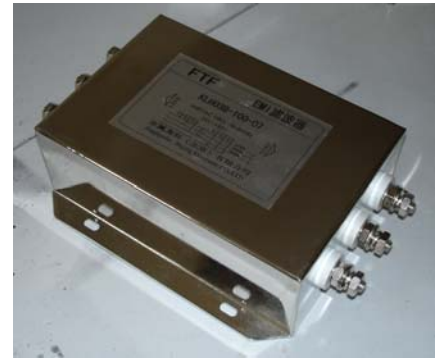

产品特点

- ▲ 滤波电感采用新型超微晶材料。
- ▲ 泄漏电流小。
- ▲ 重量轻,体积小,低频性能好,能有效的抑制变频器所造成各类低频干扰噪声。

Features

- ▲ New type soft ferrites are used for CM and DM inductors.
- ▲ Lower leakage current.
- ▲ light weight ,compact and good low frequency performance. Effective suppression to low frequency transient interference from inverters.

技术指标

- ▲ 额定电压: 440VAC
- ▲ 工作频率: 50/60Hz
- ▲ 泄漏电流: <20 mA (250VAC/50Hz)
- ▲ 测试电压: 线—线: 1450VDC, 一分钟. 线—地: 1500VAC, 一分钟
- ▲ 温度范围: -25℃~+85℃

Specification

- ▲ Rated Voltage: 440VAC
- ▲ Line Frequency: 50/60Hz
- ▲ Leakage Current: <20 mA(250VAC/50Hz)
- ▲ Test Voltage: Line—Line: 1450VDC, 1 min. Line—Ground: 1500VAC, 1 min.
- ▲ Temperature Range: -25℃~+85℃

应用场合

适用于变频器和 IGBT 驱动的电力电子设备。

Application

Designed for the inverters and electronic equipments driven by IGBT .

电路原理图 Electrical Schematics

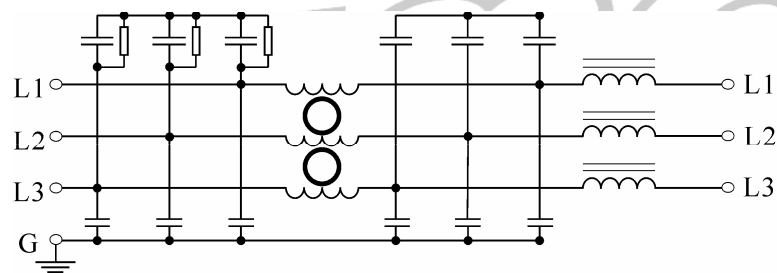

变频器专用型滤波器参数表 *Inverter Filters Parameter List*

型号	额定 电流 (A)	外形 尺寸 图号	原理 电路 图号	对应变频 器功率		06	插入损耗 (dB) 共模/差模 (CM/DM)									
							测试频率(MHz)									
							0.01	0.05	0.10	0.15	0.5	1.0	5.0	10	20	30
F-LWE3-06-??	6	E3	W	1.2	2.2	06	17/23	25/30	30/31	31/33	40/50	55/55	60/60	63/63	60/62	58/62
F-LWE3-10-??	10	E3	W	2.2	3.0	06	15/23	23/29	27/31	28/33	38/48	51/53	62/57	63/63	58/62	56/62
F-LWE3-15-??	15	E3	W	4.7	5.5	06	15/23	23/29	27/31	28/33	38/48	51/53	62/57	63/63	58/62	56/62
F-LWF3-20-??	20	F3	W	5.5	7.5	06	13/19	24/30	28/34	30/36	39/45	48/53	52/57	63/63	62/62	58/58
F-LWG3-30-??	30	G3	W	11	15	06	16/11	24/23	31/24	34/30	39/47	61/64	74/74	74/74	72/72	68/68
F-LWG3-40-??	40	G3	W	15	18.5	06	11/5	17/10	20/15	21/20	34/36	41/56	63/61	63/63	56/56	51/52
F-LWG3-50-??	50	G3	W	22		06	9/15	17/26	19/31	20/31	28/37	37/42	61/57	64/70	63/75	60/60
F-LWG3-60-??	60	G3	W	27	30	06	9/15	17/26	19/31	20/31	28/37	37/42	61/57	64/70	63/75	60/60
F-LWH3-40-??	40	H3	W	15	18.5	06	11/17	16/22	19/25	22/27	40/42	55/55	76/76	76/76	63/63	68/66
F-LWH3-50-??	50	H3	W	22		06	11/17	16/22	19/25	22/27	40/42	55/55	76/76	76/76	63/63	68/66
F-LWH3-65-??	65	H3	W	27	30	06	9/15	14/20	17/23	22/27	40/42	55/55	76/76	76/76	63/63	68/66
F-LWH3-80-??	80	H3	W	37		06	7/10	12/18	15/20	20/24	37/39	53/53	74/74	74/74	63/63	68/66
F-LWZ3-100-?	100	Z3	W	45		06	16/11	24/23	31/24	34/30	39/47	61/64	74/74	74/74	72/72	68/68
F-LWZ3-150-?	150	Z3	W	55		06	13/8	20/19	28/22	32/28	36/44	59/62	72/71	72/71	70/70	66/66
F-LWZ3-180-?	180	Z3	W	75	90	06	13/5	19/10	21/15	22/20	36/37	41/56	63/61	63/63	56/56	51/52
F-LWZ3-200-?	200	Z3	W	90		06	9/9	14/24	16/28	17/33	25/35	35/33	57/55	60/63	54/36	29/33
F-LWZ3-260-?	260	Z3	W	120		06	9/9	14/24	16/28	17/33	25/35	35/33	57/55	60/63	54/36	29/33
F-LWZ3-320-?	320	Z3	W	145		06	9/9	14/24	16/28	17/33	25/35	35/33	57/55	60/63	54/36	29/33
F-LWL3-420-?	420	L3	W	200		06	9/9	14/24	16/28	17/33	25/35	35/33	57/55	60/63	54/36	29/33
F-LWL3-520-?	520	L3	W	250		06	9/9	14/24	16/28	17/33	25/35	35/33	57/55	60/63	54/36	29/33
F-LWL3-620-?	620	L3	W	300		06	9/9	14/24	16/28	17/33	25/35	35/33	57/55	60/63	54/36	29/33
F-LWL3-720-?	720	L3	W	350		06	9/9	14/24	16/28	17/33	25/35	35/33	57/55	60/63	54/36	29/33

外形尺寸详见外形版

直流滤波器 DC filters



产品特点

- ▲ 专为抑制直流电源线干扰而设计。
- ▲ 采用新型软磁材料。
- ▲ 体积小、重量轻、性能可靠、价格低廉等优点。

Features

- ▲ Specially designed for suppressing DC power line disturbances.
- ▲ New type soft ferrites.
- ▲ Compact, light weight, reliable and low cost.

技术指标

- ▲ 额定电压: 100VDC
- ▲ 测试电压: 线—线: 200VDC, 一分钟
线—地: 500VDC, 一分钟
- ▲ 温度范围: -25°C ~ +85°C

Specification

- ▲ Rated Voltage: 100VDC
- ▲ Test Voltage: Line-Line: 200VDC, 1 min.
Line-Ground: 500VDC, 1 min.
- ▲ Temperature Range: -25°C ~ +85°C

应用场合

适用于程控交换机、光端机、开关电源以及直流供电设备。



Application

Suited for DC powered switching gear, multiplex, SDH, PDH, switching-mode power supply and electronic instruments.

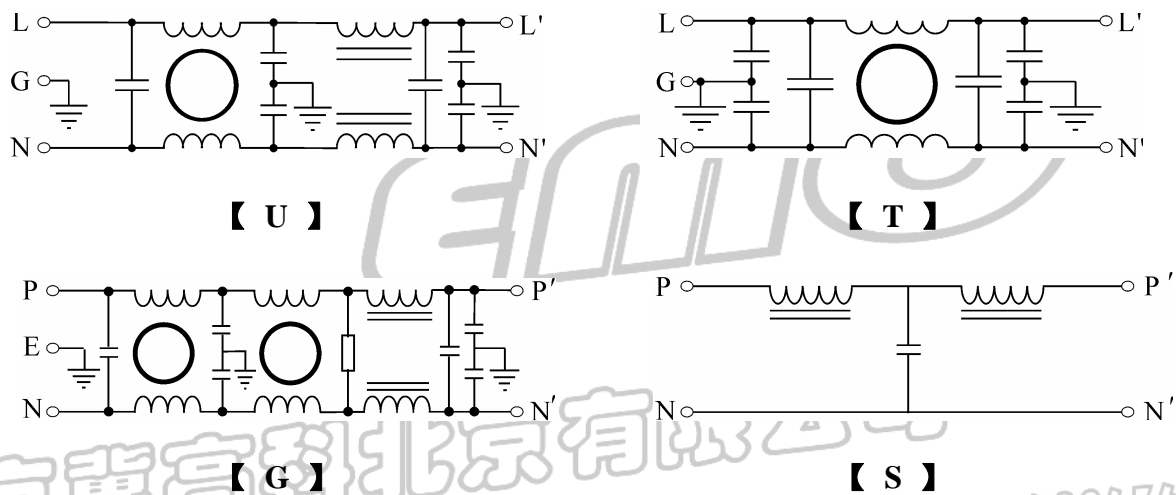
电路原理图 Electrical Schematics



直流滤波器参数表 DC Filter Parameter List

型号	额定 电流 (A)	外形 尺寸 图号	原理 电路 图号	外形			插入损耗 (dB) 共模/差模 (CM/DM)									
							测试频率(MHz)									
				06	07	08	0.01	0.05	0.10	0.15	0.5	1.0	5.0	10	20	30
F-FTB1-02-??	2	B1	T			08	8/15	20/27	28/33	33/47	53/60	68/68	64/69	63/64	62/64	58/60
F-FTB1-03-??	3	B1	T			08	5/12	20/25	28/30	31/42	50/56	62/65	64/69	63/69	62/64	60/62
F-FTB2-02-??	2	B2	T			08	8/15	20/27	28/33	33/47	53/60	68/68	64/69	63/64	62/64	58/60
F-FTB2-03-??	3	B2	T			08	5/12	20/25	28/30	31/42	50/56	62/65	64/69	63/69	62/64	60/62
F-LTD1-10-??	10	D1	T	06	07		19/25	31/33	39/47	47/53	62/68	62/62	63/63	53/57	50/52	48/50
F-LTD2-10-??	10	D2	T	06	07		19/25	31/33	39/47	47/53	62/68	62/62	63/63	53/57	50/52	48/50
F-FUB1-01-??	1	B1	U			08	18/19	28/36	41/51	53/63	71/77	71/77	71/65	71/62	67/56	56/56
F-FUB1-02-??	2	B1	U			08	7/14	28/24	30/41	35/42	58/53	66/62	74/69	74/63	66/62	62/58
F-FUB1-03-??	3	B1	U			08	5/9	18/27	21/29	32/41	67/71	71/73	71/65	71/64	67/62	66/62
F-FUB2-01-??	1	B2	U			08	18/19	28/36	41/51	53/63	71/77	71/77	71/65	71/62	67/56	56/56
F-FUB2-02-??	2	B2	U			08	7/14	28/24	30/41	35/42	58/53	66/62	74/69	74/63	66/62	62/58
F-FUB2-03-??	3	B2	U			08	5/9	18/27	21/29	32/41	67/71	71/73	71/65	71/64	67/62	66/62
F-FUC2-03-??	3	C2	U			08	18/19	28/36	41/51	53/63	71/77	71/77	71/65	71/62	67/56	56/56
F-FUC2-06-??	6	C2	U			08	7/14	28/24	30/41	35/42	58/53	66/62	74/69	74/63	66/62	62/58
F-FUD1-06-??	6	D1	U	06	07		16/14	29/37	38/49	53/63	65/65	65/65	70/70	71/65	62/62	56/56
F-FUD2-06-??	6	D2	U	06	07		16/14	29/37	38/49	53/63	65/65	65/65	70/70	71/65	62/62	56/56
F-FUP1-06-??	6	P1	U	06	07		16/14	29/37	38/49	53/63	65/65	65/65	70/70	71/65	62/62	56/56
F-FUP1-10-??	10	P1	U	06	07		16/14	29/37	38/49	53/63	65/65	65/65	70/70	71/65	62/62	56/56
F-FUE2-20-??	20	E2	U	06	07		18/13	26/21	31/53	39/62	50/68	62/63	69/63	57/60	52/58	52/54
F-FUF2-30-??	30	F2	U	06			8/15	20/27	28/33	33/47	53/60	68/68	64/69	63/64	62/64	58/60
F-FUG2-50-??	50	G2	U	06			18/13	26/21	31/53	39/62	50/68	62/63	69/63	57/60	52/58	52/54
F-FUS1-10-??	10	S1	U	06			21/16	28/23	33/55	40/63	50/68	62/63	69/63	57/60	54/60	53/56
F-FUS1-20-??	20	S1	U	06			18/13	26/21	31/53	39/62	50/68	62/63	69/63	57/60	52/58	52/54
F-FGE2-06-??	6	E2	G	06			23/20	38/28	45/55	55/62	62/68	65/65	69/65	60/62	55/58	52/54
F-FGE2-10-??	10	E2	G	06			21/18	35/25	41/53	50/62	62/68	65/65	69/65	60/62	55/58	52/54
F-FGF2-20-??	20	F2	G	06			21/18	35/25	41/53	50/62	62/68	65/65	69/65	60/62	55/58	52/54
F-LSD1-10-??	10	D1	S	06	07		-13	-56	-68	-70	-68	-68	-60	-57	-52	-50
F-LSD2-10-??	10	D2	S	06	07		-13	-56	-68	-70	-68	-68	-60	-57	-52	-50
F-LSP1-15-??	15	P1	S	06	07		-13	-56	-68	-70	-68	-68	-60	-57	-52	-50
F-LSB1-03-??	3	B1	S			08	-14	-57	-68	-71	-69	-69	-61	-57	-52	-50
F-LSC1-06-??	6	C1	S		07	08	-14	-57	-70	-72	-69	-69	-62	-59	-54	-50

外形尺寸详见外形尺寸版

PCB 插针型 & IEC 标准插座型滤波器



产品特点

- ▲ 对差模和共模干扰具有良好的抑制特性。
- ▲ 泄漏电流小。
- ▲ 体积小，重量轻，性能可靠、价格低廉。

Features

- ▲ General purpose filters with a good suppression to common-mode and differential-mode interference.
- ▲ Lower leakage current.
- ▲ Compact, light weight, reliable and low cost

技术指标

- ▲ 额定电压: 115/250VAC
- ▲ 工作频率: 50/60Hz
- ▲ 泄漏电流: < 0.5 mA (250VAC/50Hz)
- ▲ 测试电压: 线—线: 1450VDC, 一分钟。 线—地 : 1500VAC, 一分钟。
- ▲ 温度范围: -25°C~+85°C

Specification

- ▲ Rated Voltage: 115/250VAC
- ▲ Line Frequency: 50/60Hz
- ▲ Leakage Current: <0.5 mA(250VAC/50Hz)
- ▲ Test Voltage: Line—Line: 1450VDC, 1 min. Line—Ground: 1500VAC, 1 min.
- ▲ Temperature Range: -25°C~+85°C

应用场合

开关电源、UPS 电源、医疗设备、仪器仪表等电力电子设备。

Application

Switching-mode power supply, UPS, medical equipments and electronic instruments etc.

电路原理图 Electrical Schematics

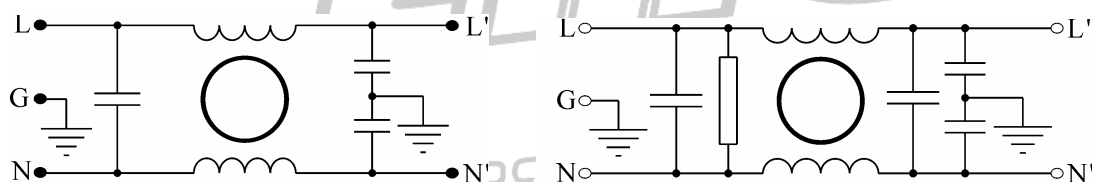

【 A 】

【 B 】

PCB 插针型滤波器参数表

型号	额定 电流 (A)	外形 尺寸 图号	原理 电路 图号	I	插入损耗 (dB) 共模/差模 (CM/DM)									
					测试频率(MHz)									
					05	0.01	0.05	0.10	0.15	0.5	1.0	5.0	10	20
F-FAA6-01-05	1	A6	A	05	10/5	23/10	29/15	32/19	42/30	48/39	53/51	57/57	68/58	62/60
F-FAA6-02-05	2	A6	A	05	8/5	19/10	23/15	30/19	35/28	41/35	53/49	57/53	68/62	62/62
F-FAA6-03-05	3	A6	A	05	5/4	15/9	20/14	22/18	33/28	40/34	50/42	53/51	62/65	62/62
F-FAB6-03-05	3	B6	A	05	11/5	23/10	29/15	32/19	37/29	41/36	49/53	52/55	55/54	50/52
F-FAB6-06-05	6	B6	A	05	5/4	13/9	19/15	22/18	31/28	35/33	49/55	52/57	56/56	58/52
F-FAN6-01-05	1	N6	A	05	10/5	23/10	29/15	32/19	42/30	48/39	53/51	57/57	68/58	62/60
F-FAN6-02-05	2	N6	A	05	8/5	19/10	23/15	30/19	35/28	41/35	53/49	57/53	68/62	62/62
F-FAN6-03-05	3	N6	A	05	5/4	15/9	20/14	22/18	33/28	40/34	50/42	53/51	62/65	62/62
F-FAY6-01-05	1	Y6	A	05	17/7	28/12	35/17	40/22	45/33	48/40	49/55	52/55	55/54	50/52
F-FAY6-02-05	2	Y6	A	05	15/7	26/11	32/15	35/19	40/30	41/36	49/53	52/55	55/54	50/52
F-FAY6-03-05	3	Y6	A	05	11/5	23/10	29/15	32/19	37/29	41/36	49/53	52/55	55/54	50/52
F-FAY6-06-05	6	Y6	A	05	5/4	13/9	19/15	22/18	31/28	35/33	49/55	52/57	56/56	58/52

IEC 标准插座型滤波器参数表

型号	额定 电流 (A)	外形 尺寸 图号	原理 电路 图号	II	插入损耗 (dB) 共模/差模 (CM/DM)									
					测试频率(MHz)									
					07	0.01	0.05	0.10	0.15	0.5	1.0	5.0	10	20
F-FAI1-01-07	1	I1	A	07	10/5	23/10	29/15	32/19	42/30	48/39	53/51	57/57	68/58	62/60
F-FAI1-02-07	2	I1	A	07	8/5	19/10	23/15	30/19	35/28	41/35	53/49	57/53	68/62	62/62
F-FAI1-03-07	3	I1	A	07	5/4	15/9	20/14	22/18	33/28	40/34	50/42	53/51	62/65	62/62
F-FAI1-06-07	6	I1	A	07	4/3	13/7	19/13	21/17	33/28	40/34	50/42	53/51	62/65	61/61
F-FAJ1-03-07	3	J1	A	07	11/5	23/10	29/15	32/19	37/29	41/36	49/53	52/55	55/54	50/52
F-FAJ1-06-07	6	J1	A	07	5/4	13/9	19/15	22/18	31/28	35/33	49/55	52/57	56/56	58/52
F-FAJ1-10-07	10	J1	A	07	5/4	13/9	19/15	22/18	31/28	35/33	49/55	52/57	56/56	58/52
F-FAJ2-03-07	3	J2	A	07	11/5	23/10	29/15	32/19	37/29	41/36	49/53	52/55	55/54	50/52
F-FAJ2-06-07	6	J2	A	07	5/4	13/9	19/15	22/18	31/28	35/33	49/55	52/57	56/56	58/52
F-FAJ2-10-07	10	J2	A	07	5/4	13/9	19/15	22/18	31/28	35/33	49/55	52/57	56/56	58/52
F-FAK1-06-07	6	K1	A	07	8/5	19/10	23/15	30/19	35/28	41/35	53/49	57/53	68/62	62/62
F-FAK1-10-07	10	K1	A	07	6/10	18/23	24/29	27/33	35/41	46/50	60/62	65/68	62/70	54/55
F-FAK1-15-07	15	K1	A	07	6/10	18/23	24/29	27/33	35/41	46/50	60/62	65/68	62/70	54/55
F-FAK1-20-07	20	K1	A	07	4/8	16/21	22/27	25/31	35/41	46/50	60/62	65/68	61/70	52/53
F-FBJ1-06-07	6	J1	B	07	11/7	23/18	30/21	32/22	37/50	42/53	53/63	53/63	68/65	62/68
F-FBJ1-10-07	10	J1	B	07	8/5	19/10	23/15	30/19	35/28	41/35	53/49	57/53	68/62	62/62
F-FBK1-10-07	10	K1	B	07	11/7	23/18	30/21	32/22	37/50	42/53	53/63	53/63	68/65	62/68
F-FBK1-15-07	15	K1	B	07	8/5	19/10	23/15	30/19	35/28	41/35	53/49	57/53	68/62	62/62

军用交流单相高性能滤波器 Military High Performance Filters



产品特点

- ▲ 双级共模一级差模滤波电路，具有良好的共模和差模干扰抑制特性，能有效抑制各种高频瞬态干扰。
- ▲ 专为军用设备通过电磁兼容军标 GJB 151A/152A 中 CE102 传导发射的要求而设计。
- ▲ 为用户定做特殊要求的军用滤波器。

Features

- ▲ The filters of two CM plus one DM sections can provide good performance in suppressing both CM and DM noises. Effective suppression to high frequency transient interference.
- ▲ Specially designed for military use to meet the demand of conducting emission regulated by CE102,GJB151A/152A.
- ▲ Custom-make military use EMI filters according to customers' special requirements.

技术指标

- ▲ 额定电压: 115/250VAC
- ▲ 工作频率: 50/60Hz
- ▲ 泄漏电流: <1.0 mA(250VAC/50Hz)
- ▲ 测试电压: 线—线: 1450VDC, 一分钟。 线—地 : 1500VAC, 一分钟。
- ▲ 温度范围: -55℃~+85℃

Specification

- ▲ Rated Voltage: 115/250VAC
- ▲ Line Frequency: 50/60Hz
- ▲ Leakage Current: <1.0 mA(250VAC/50Hz)
- ▲ Test Voltage: Line—Line 1450VDC, 1 min. Line—Ground 1500VAC, 1 min.
- ▲ Temperature Range: -55℃~+85℃

应用场合

适用于要求满足 FCC B 级、VDE0871 电磁兼容标准要求的电力电子设备。

Application

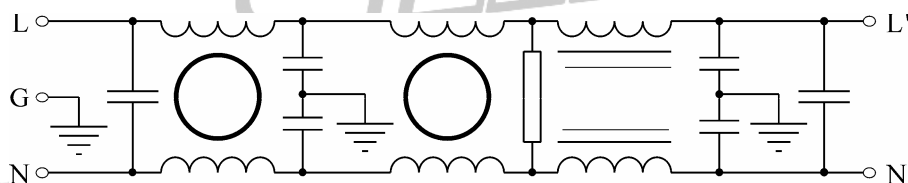

Suited for power and electronic equipments which must meet the EMC requirements of FCC Class B and VDE0871.

电路原理图 Electrical Schematics



【 F 】

军用交流单相高性能滤波器参数表
 Military High Performance Filter Parameter List

型号	额定 电流 (A)	外形 尺寸 图号	原理 电路 图号				插入损耗 (dB) 共模/差模 (CM/DM)									
							测试频率(MHz)									
							0.01	0.05	0.10	0.15	0.5	1.0	5.0	10	20	30
F-FFB1J-01-??	1	B1	F			08	18/7	20/13	44/36	53/46	67/67	66/67	63/63	63/57	70/53	64/56
F-FFB1J-02-??	2	B1	F			08	18/7	20/13	44/36	53/46	67/67	66/67	63/63	63/57	70/53	64/56
F-FFB2J-01-??	1	B2	F			08	18/7	20/13	44/36	53/46	67/67	66/67	63/63	63/57	70/53	64/56
F-FFB2J-02-??	2	B2	F			08	18/7	20/13	44/36	53/46	67/67	66/67	63/63	63/57	70/53	64/56
F-FFC1J-02-??	2	C1	F		07	08	14/10	15/15	41/35	54/47	76/76	76/76	77/77	77/77	70/66	66/68
F-FFC1J-03-??	3	C1	F		07	08	11/6	18/14	30/33	41/43	63/71	71/71	71/63	68/57	61/53	70/52
F-FFC2J-02-??	2	C2	F		07		14/10	15/15	41/35	54/47	76/76	76/76	77/77	77/77	70/66	66/68
F-FFC2J-03-??	3	C2	F		07		11/6	18/14	30/33	41/43	63/71	71/71	71/63	68/57	61/53	70/52
F-FFD1J-02-??	2	D1	F	06	07		16/10	21/21	45/41	56/53	76/76	76/76	77/77	77/77	68/72	68/66
F-FFD1J-03-??	3	D1	F	06	07		14/10	15/15	41/35	54/47	76/76	76/76	77/77	77/77	70/66	66/68
F-FFD2J-02-??	2	D2	F	06	07		16/10	21/21	45/41	56/53	76/76	76/76	77/77	77/77	68/72	68/66
F-FFD2J-03-??	3	D2	F	06	07		14/10	15/15	41/35	54/47	76/76	76/76	77/77	77/77	70/66	66/68
F-LFD1J-02-??	2	D1	F	06	07		21/15	26/26	48/44	58/55	76/76	76/76	77/77	77/77	68/72	68/66
F-LFD1J-03-??	3	D1	F	06	07		18/14	20/20	44/40	56/49	76/76	76/76	77/77	77/77	70/66	66/68
F-LFD2J-02-??	2	D2	F	06	07		21/15	26/26	48/44	58/55	76/76	76/76	77/77	77/77	68/72	68/66
F-LFD2J-03-??	3	D2	F	06	07		18/14	20/20	44/40	56/49	76/76	76/76	77/77	77/77	70/66	66/68
F-FFE2J-06-??	6	E2	F	06	07		17/6	23/14	50/36	56/48	70/70	68/70	70/72	70/72	74/74	68/68
F-FFE2J-10-??	10	E2	F	06	07		6/8	15/28	18/29	33/45	57/68	70/74	70/72	65/65	63/66	60/66
F-LFE2J-06-??	6	E2	F	06	07		21/15	26/26	48/44	58/55	76/76	76/76	77/77	77/77	68/72	68/66
F-LFE2J-10-??	10	E2	F	06	07		18/14	20/20	44/40	56/49	76/76	76/76	77/77	77/77	70/66	66/68
F-FFF2J-20-??	20	F2	F	06			6/8	15/28	18/29	33/46	57/63	74/70	74/73	70/72	63/66	60/64
F-LFF2J-20-??	20	F2	F	06			16/8	19/13	25/25	37/39	62/68	74/74	74/74	73/72	72/68	68/70
F-FFG2J-30-??	30	G2	F	06			17/9	20/14	26/26	37/39	62/68	74/74	74/74	73/72	72/70	68/70
F-LFG2J-30-??	30	G2	F	06			22/16	27/27	50/48	58/55	76/76	76/76	77/77	77/77	68/72	68/66
F-FFS1J-06-??	6	S1	F	06	07		17/6	23/14	50/36	56/48	70/70	68/70	70/72	70/72	74/74	68/68
F-FFS1J-10-??	10	S1	F	06	07		6/8	15/28	18/29	33/45	57/68	70/74	70/72	65/65	63/66	60/66
F-LFS1J-06-??	6	S1	F	06	07		23/16	27/20	54/36	56/48	70/70	68/70	70/72	70/72	74/74	70/70
F-LFS1J-10-??	10	S1	F	06	07		16/12	19/28	25/29	33/45	57/68	70/74	70/72	68/69	68/69	66/69

外形尺寸详见外形尺寸版

军用交流三相滤波器 Military Three phase Filters

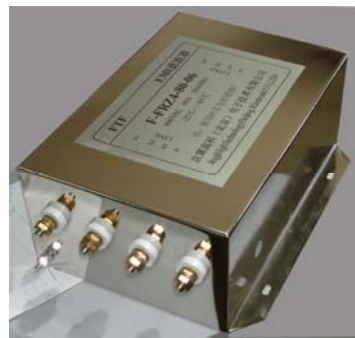

产品特点

- ▲ 专为军用设备通过电磁兼容军标 GJB 151A/152A 中 CE102 传导发射的要求而设计。
- ▲ 共模和差模电感均采用新型软磁材料。
- ▲ 泄漏电流小。
- ▲ 体积小，重量轻，低频性能好。

Features

- ▲ Specially designed for military use to meet the demand of conducting emission regulated by CE102,GJB151A/152A.
- ▲ New type soft ferrites in CM and DM inductors.
- ▲ Lower leakage current.
- ▲ compact, light weight and good low frequency performance.

技术指标

- ▲ 额定电压: 440VAC
- ▲ 工作频率: 50/60Hz
- ▲ 泄漏电流: <2.0 mA(250VAC/50Hz)
- ▲ 测试电压: 线—线: 1450VDC, 一分钟. 线—地: 1500VAC, 一分钟
- ▲ 温度范围: -55℃~+85℃



Specification

- ▲ Rated Voltage: 440VAC
- ▲ Line Frequency: 50/60Hz
- ▲ Leakage Current: <2.0 mA(250VAC/50Hz)
- ▲ Test Voltage: Line—Line: 1450VDC, 1 min. Line—Ground: 1500VAC, 1 min.
- ▲ Temperature Range: -55℃~+85℃

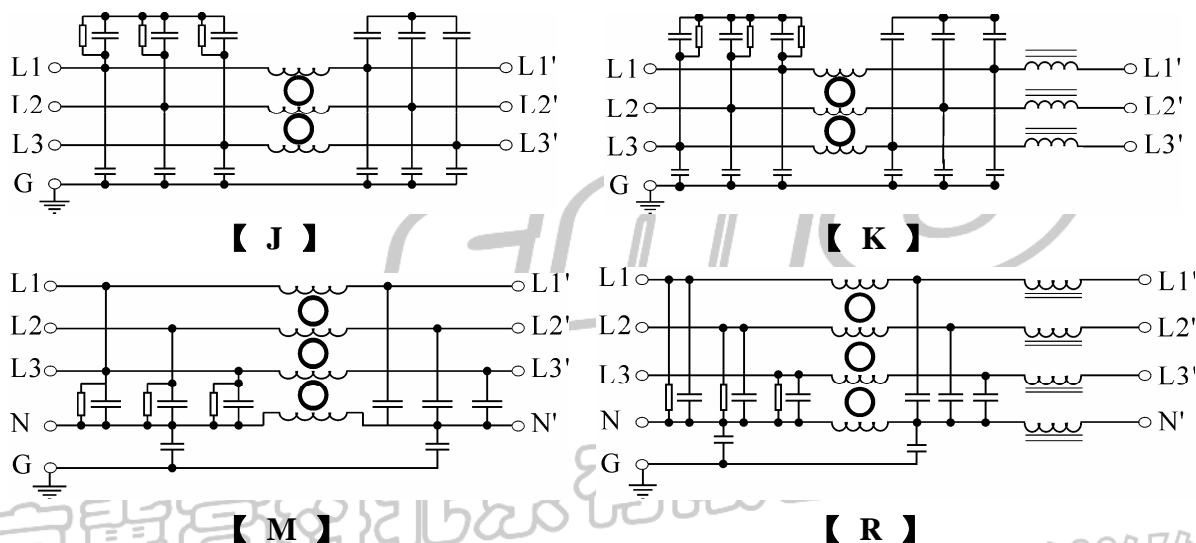
电路原理图 Electrical Schematics



军用交流三相滤波器参数表
Military Three phase Filter Parameter List

型号	额定 电流 (A)	外形 尺寸 图号	原理 电路 图号				插入损耗 (dB) 共模/差模 (CM/DM)									
							测试频率(MHz)									
							06	07	08	0.01	0.05	0.10	0.15	0.5	1.0	5.0
F-FJE3J-06-??	6	E3	J	06	07		10/4	15/8	19/14	20/19	36/37	41/56	63/61	63/63	56/56	50/51
F-FJE3J-10-??	10	E3	J	06	07		9/4	14/7	19/13	20/19	36/37	41/56	63/61	63/63	56/56	50/51
F-LJE3J-06-??	6	E3	J	06	07		13/5	19/10	21/15	22/20	36/37	41/56	63/61	63/63	56/56	51/52
F-LJE3J-10-??	10	E3	J	06	07		13/5	19/10	21/15	22/20	36/37	41/56	63/61	63/63	56/56	51/52
F-LKE3J-06-??	6	E3	K	06	07		17/23	25/30	30/31	31/33	40/50	55/55	60/60	63/63	60/62	58/62
F-LKE3J-10-??	10	E3	K	06	07		15/23	23/29	27/31	28/33	38/48	51/53	62/57	63/63	58/62	56/62
F-LKE3J-15-??	15	E3	K	06	07		15/23	23/29	27/31	28/33	38/48	51/53	62/57	63/63	58/62	56/62
F-LJF3J-20-??	20	F3	J	06			11/8	19/18	24/24	37/30	39/45	48/53	69/71	65/65	64/64	58/57
F-LKF3J-20-??	20	F3	K	06			13/19	24/30	28/34	30/36	39/45	48/53	52/57	63/63	62/62	58/58
F-LJF3J-30-??	30	F3	J	06			10/16	21/27	26/31	28/34	37/43	46/51	51/56	62/62	62/62	58/58
F-LKG3J-40-??	40	G3	K	06			16/11	24/23	31/24	34/30	39/47	61/64	74/74	74/74	72/72	68/68
F-FKG3J-50-??	50	G3	K	06			9/15	17/26	19/31	20/31	28/37	37/42	61/57	64/70	63/75	60/60
F-FKG3J-60-??	60	G3	K	06			9/15	17/26	19/31	20/31	28/37	37/42	61/57	64/70	63/75	60/60
F-LKG3J-50-??	50	G3	K	06			13/5	19/10	21/15	22/20	36/37	41/56	63/61	63/63	56/56	51/52
F-LKG3J-60-??	60	G3	K	06			11/5	17/10	20/15	21/20	34/36	41/56	63/61	63/63	56/56	51/52
F-LKH3J-40-??	40	H3	K	06			11/17	16/22	19/25	22/27	40/42	55/55	76/76	76/76	63/63	68/66
F-LKH3J-50-??	50	H3	K	06			11/17	16/22	19/25	22/27	40/42	55/55	76/76	76/76	63/63	68/66
F-LKH3J-60-??	60	H3	K	06			9/15	14/20	17/23	22/27	40/42	55/55	76/76	76/76	63/63	68/66
F-LKH3J-80-??	80	H3	K	06			7/10	12/18	15/20	20/24	37/39	53/53	74/74	74/74	63/63	68/66
F-LJH3J-80-??	80	H3	J	06			11/8	19/18	24/24	37/30	39/45	48/53	69/71	65/65	64/64	58/57
F-LJH3J-100-??	100	H3	J	06			11/5	19/10	21/15	22/20	36/37	41/56	63/61	63/63	56/56	51/52
F-LKZ3J-100-??	100	Z3	K	06			16/11	24/23	31/24	34/30	39/47	61/64	74/74	74/74	72/72	68/68
F-LKZ3J-200-??	200	Z3	K	06			9/9	14/24	16/28	17/33	25/35	35/33	57/55	60/63	54/36	29/33
F-LJZ3J-300-??	300	Z3	J	06			10/4	15/8	19/14	20/19	36/37	41/56	63/61	63/63	56/56	50/51
F-LME4J-06-??	6	E4	M	06			16/5	21/10	23/15	25/26	38/40	45/53	69/69	60/57	56/56	52/52
F-LME4J-10-??	10	E4	M	06			13/5	19/10	21/15	22/20	36/37	41/56	63/61	63/63	56/56	51/52
F-LME4J-15-??	15	E4	M	06			13/5	19/10	21/15	22/20	36/37	41/56	63/61	63/63	56/56	51/52
F-LMF4J-20-??	20	F4	M	06			9/8	19/19	21/24	23/28	36/40	47/53	77/73	63/63	62/58	56/56
F-LMF4J-30-??	30	F4	M	06			7/6	17/17	19/22	23/28	36/40	47/53	77/73	63/63	62/58	56/56
F-LMG4J-40-??	40	G4	M	06			10/14	14/24	15/27	19/30	25/34	35/39	60/60	71/71	76/76	72/72
F-LRG4J-40-??	40	G4	R	06			8/13	12/18	14/19	15/20	22/26	30/30	62/60	76/76	65/65	60/63
F-LMG4J-50-??	50	G4	M	06			9/15	17/26	19/31	20/31	28/37	37/42	61/57	64/70	63/75	60/60
F-LMH4J-80-??	80	H4	M	06			14/18	18/28	20/31	22/32	25/34	35/39	60/60	71/71	76/76	72/72
F-LMH4J-100-??	100	H4	M	06			10/14	14/24	15/27	1/1	25/34	35/39	60/60	71/71	76/76	72/72
F-LRH4J-40-??	40	H4	R	06			8/13	12/18	14/19	15/20	22/26	30/30	62/60	76/76	65/65	60/63
F-LRH4J-50-??	50	H4	R	06			14/18	18/28	20/31	22/32	25/34	35/39	60/60	71/71	76/76	72/72
F-LRZ4-100J-??	100	Z4	R	06			16/11	24/23	31/24	34/30	39/47	61/64	74/74	74/74	72/72	68/68

军用直流滤波器 Military DC filters



产品特点

- ▲ 专为军用设备通过电磁兼容军标 GJB 151A/152A 中 CE102 传导发射的要求而设计。
- ▲ 专为抑制直流电源线干扰而设计。
- ▲ 采用新型软磁材料。

Features

- ▲ Specially designed for military use to meet the demand of conducting emission regulated by CE102,GJB151A/152A.
- ▲ Specially designed for suppressing DC power line disturbances.
- ▲ New type soft ferrites.

技术指标

- ▲ 额定电压: 100VDC
- ▲ 测试电压: 线—线: 200VDC, 一分钟
线—地: 500VDC, 一分钟
- ▲ 温度范围: -55℃~+85℃

Specification

- ▲ Rated Voltage: 100VDC
- ▲ Test Voltage: Line-Line: 200VDC, 1 min.
Line-Ground: 500VDC, 1 min.
- ▲ Temperature Range: -55℃~+85℃

应用场合

适用于程控交换机、光端机、开关电源以及直流供电设备。



Application

Suited for DC powered switching gear, multiplex, SDH, PDH, switching-mode power supply and electronic instruments.

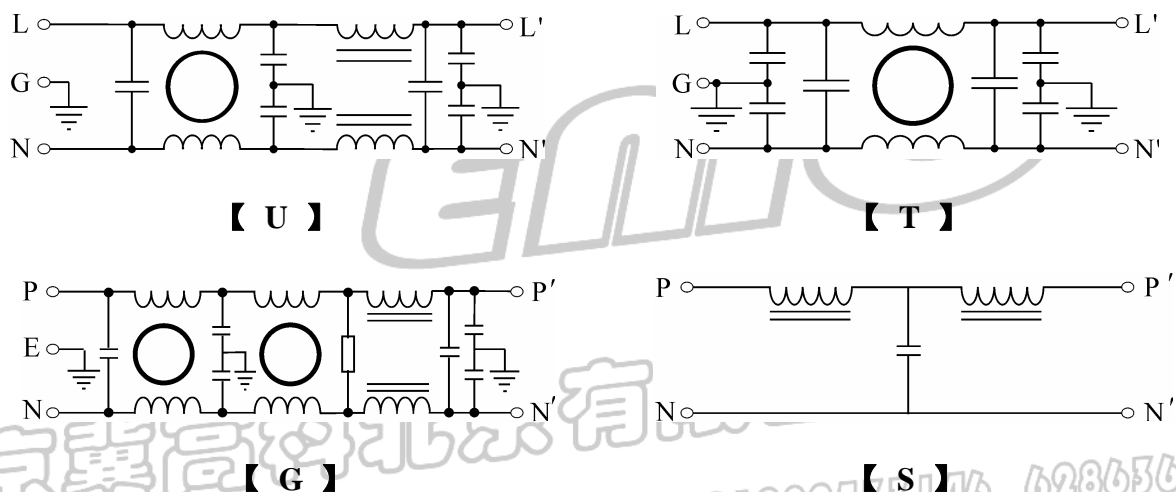
电路原理图 Electrical Schematics



军用直流滤波器参数表 *Military DC Filter Parameter List*

型号	额定 电流 (A)	外形 尺寸 图号	原理 电路 图号	  			插入损耗 (dB) 共模/差模 (CM/DM)									
				06	07	08	测试频率(MHz)									
							0.01	0.05	0.10	0.15	0.5	1.0	5.0	10	20	30
F-FTB1J-02-??	2	B1	T			08	8/15	20/27	28/33	33/47	53/60	68/68	64/69	63/64	62/64	58/60
F-FTB1J-03-??	3	B1	T			08	5/12	20/25	28/30	31/42	50/56	62/65	64/69	63/69	62/64	60/62
F-FTB2J-02-??	2	B2	T			08	8/15	20/27	28/33	33/47	53/60	68/68	64/69	63/64	62/64	58/60
F-FTB2J-03-??	3	B2	T			08	5/12	20/25	28/30	31/42	50/56	62/65	64/69	63/69	62/64	60/62
F-LTD1J-10-??	10	D1	T	06	07		19/25	31/33	39/47	47/53	62/68	62/62	63/63	53/57	50/52	48/50
F-LTD2J-10-??	10	D2	T	06	07		19/25	31/33	39/47	47/53	62/68	62/62	63/63	53/57	50/52	48/50
F-FUB1J-01-??	1	B1	U			08	18/19	28/36	41/51	53/63	71/77	71/77	71/65	71/62	67/56	56/56
F-FUB1J-02-??	2	B1	U			08	7/14	28/24	30/41	35/42	58/53	66/62	74/69	74/63	66/62	62/58
F-FUB1J-03-??	3	B1	U			08	5/9	18/27	21/29	32/41	67/71	71/73	71/65	71/64	67/62	66/62
F-FUB2J-01-??	1	B2	U			08	18/19	28/36	41/51	53/63	71/77	71/77	71/65	71/62	67/56	56/56
F-FUB2J-02-??	2	B2	U			08	7/14	28/24	30/41	35/42	58/53	66/62	74/69	74/63	66/62	62/58
F-FUB2J-03-??	3	B2	U			08	5/9	18/27	21/29	32/41	67/71	71/73	71/65	71/64	67/62	66/62
F-FUC2J-03-??	3	C2	U			08	18/19	28/36	41/51	53/63	71/77	71/77	71/65	71/62	67/56	56/56
F-FUC2J-06-??	6	C2	U			08	7/14	28/24	30/41	35/42	58/53	66/62	74/69	74/63	66/62	62/58
F-FUD1J-06-??	6	D1	U	06	07		16/14	29/37	38/49	53/63	65/65	65/65	70/70	71/65	62/62	56/56
F-FUD2J-06-??	6	D2	U	06	07		16/14	29/37	38/49	53/63	65/65	65/65	70/70	71/65	62/62	56/56
F-FUP1J-06-??	6	P1	U	06	07		16/14	29/37	38/49	53/63	65/65	65/65	70/70	71/65	62/62	56/56
F-FUP1J-10-??	10	P1	U	06	07		16/14	29/37	38/49	53/63	65/65	65/65	70/70	71/65	62/62	56/56
F-FUE2J-20-??	20	E2	U	06	07		18/13	26/21	31/53	39/62	50/68	62/63	69/63	57/60	52/58	52/54
F-FUF2J-30-??	30	F2	U	06			8/15	20/27	28/33	33/47	53/60	68/68	64/69	63/64	62/64	58/60
F-FUG2J-50-??	50	G2	U	06			18/13	26/21	31/53	39/62	50/68	62/63	69/63	57/60	52/58	52/54
F-FUS1J-10-??	10	S1	U	06			21/16	28/23	33/55	40/63	50/68	62/63	69/63	57/60	54/60	53/56
F-FUS1J-20-??	20	S1	U	06			18/13	26/21	31/53	39/62	50/68	62/63	69/63	57/60	52/58	52/54
F-FGE2J-06-??	6	E2	G	06			23/20	38/28	45/55	55/62	62/68	65/65	69/65	60/62	55/58	52/54
F-FGE2J-10-??	10	E2	G	06			21/18	35/25	41/53	50/62	62/68	65/65	69/65	60/62	55/58	52/54
F-FGF2J-20-??	20	F2	G	06			21/18	35/25	41/53	50/62	62/68	65/65	69/65	60/62	55/58	52/54
F-LSD1J-10-??	10	D1	S	06	07		-13	-56	-68	-70	-68	-68	-60	-57	-52	-50
F-LSD2J-10-??	10	D2	S	06	07		-13	-56	-68	-70	-68	-68	-60	-57	-52	-50
F-LSP1J-15-??	15	P1	S	06	07		-13	-56	-68	-70	-68	-68	-60	-57	-52	-50
F-LSB1J-03-??	3	B1	S			08	-14	-57	-68	-71	-69	-69	-61	-57	-52	-50
F-LSC1J-06-??	6	C1	S		07	08	-14	-57	-70	-72	-69	-69	-62	-59	-54	-50

外形尺寸详见外形尺寸版

屏蔽室电源滤波器双线系列 Power Filters for Shielding



产品特点

- ▲ 具有抑制频带宽、抑制能力强等优点。
- ▲ 采用软线输入、输出方式，安装方便。

Features

- ▲ The shielding power filters have a good suppression for the interference with the wide bandwidth.
- ▲ Using the flexible cables for input and output, it is convenient to install

技术指标

- ▲ 额定电压: 250VAC/440VAC
- ▲ 额定电流: 2A ~ 300A
- ▲ 工作频率: 50/400Hz
- ▲ 测试电压: 线—线: 1500VDC, 一分钟。
线—地: 1500VDC, 一分钟。
- ▲ 绝缘电阻: $\geq 100M\Omega(500VDC)$
- ▲ 温度范围: $-25^{\circ}C \sim +85^{\circ}C$

Specification

- ▲ Rated Voltage: 250VAC/440VAC
- ▲ Rated current: 2A ~ 300A
- ▲ Line Frequency: 50/400Hz
- ▲ Test Voltage:
 - Line—Line: 1500VDC, 1 min.
 - Line—Ground: 1500VAC, 1 min.
- ▲ Insulation resistance: $\geq 100M\Omega(500VDC)$
- ▲ Temperature Range: $-25^{\circ}C \sim +85^{\circ}C$

应用场合

该类电源滤波器专门用于各种结构的屏蔽室及微波暗室，也可用作舱电源滤波器。

Application

This kind of power supply filters are specially used for various shielding room and microwave darkroom. This kinds of filters are also available for cabin power filter

屏蔽室电源滤波器参数表 *Shielding Filter Parameter List*

型 号	数 线	额 定 电 流 (A)	泄 漏 电 流 (A)	插 入 损 耗 (dB)	
				14kHz~150kHz	150kHz~10GHz
PBS-2-006A	2	6	≤1.5	70~100	≥100
PBS-2-010A	2	10	≤1.5	70~100	≥100
PBS-2-020A	2	20	≤1.5	70~100	≥100
PBS-2-030A	2	30	≤1.5	70~100	≥100
PBS-2-050A	2	50	≤2.0	70~100	≥100
PBS-2-080A	2	80	≤2.5	70~100	≥100
PBS-2-100A	2	100	≤3.0	70~100	≥100
PBS-2-150A	2	150	≤3.5	70~100	≥100

外形尺寸

Housing and Dimensions

型 号	A	B	C	D	E	F	G	H	I
PBS-2-006A	220	120	70	50	16	15	235	250	80
PBS-2-010A	220	120	70	50	16	15	235	250	80
PBS-2-020A	320	120	70	50	16	15	335	350	80
PBS-2-030A	320	120	70	50	16	15	335	350	80
PBS-2-050A	450	180	85	50	20	40	470	490	100
PBS-2-080A	450	180	85	50	20	40	470	490	100
PBS-2-100A	450	180	85	50	24	40	470	490	100
PBS-2-150A	500	180	110	50	18	40	520	540	120

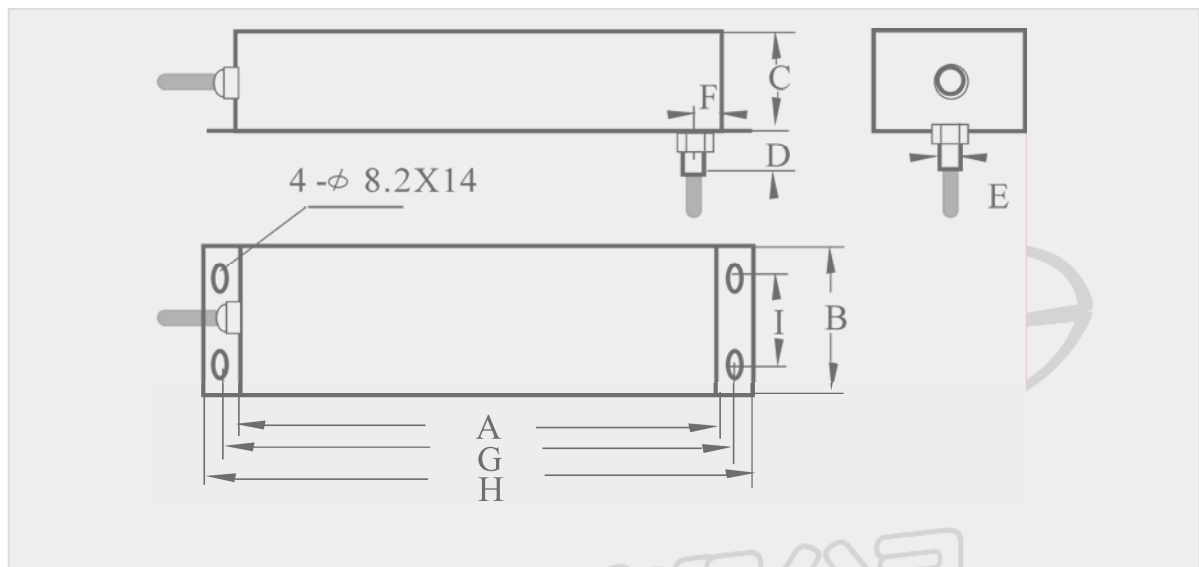

屏蔽室电源滤波器单线系列 Power Filters for Shielding

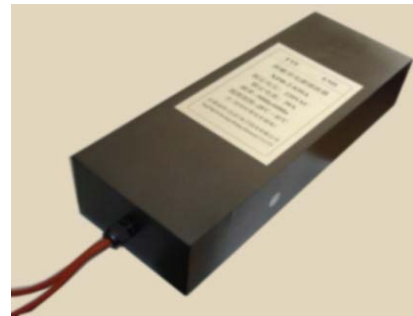

产品特点

- ▲ 具有抑制频带宽、抑制能力强等优点。
- ▲ 采用软线输入、输出方式，安装方便。

Features

- ▲ The shielding power filters have a good suppression for the interference with the wide bandwidth.
- ▲ Using the flexible cables for input and output, it is convenient to install

技术指标

- ▲ 额定电压: 250VAC/440VAC
- ▲ 工作频率: 50/400Hz
- ▲ 测试电压: 线—线: 1500VDC, 一分钟。
线—地: 1500VDC, 一分钟。
- ▲ 绝缘电阻: $\geq 100M\Omega(500VDC)$
- ▲ 温度范围: $-25^{\circ}C \sim +85^{\circ}C$

Specification

- ▲ Rated Voltage: 250VAC/440VAC
- ▲ Line Frequency: 50/400Hz
- ▲ Test Voltage:
Line—Line: 1500VDC, 1 min.
Line—Ground: 1500VAC, 1 min.
- ▲ Insulation resistance: $\geq 100M\Omega(500VDC)$
- ▲ Temperature Range: $-25^{\circ}C \sim +85^{\circ}C$

应用场合

该类电源滤波器专门用于各种结构的屏蔽室及微波暗室，也可用作舱电源滤波器。

Application

This kind of power supply filters are specially used for various shielding room and microwave darkroom. This kinds of filters are also available for cabin power filter

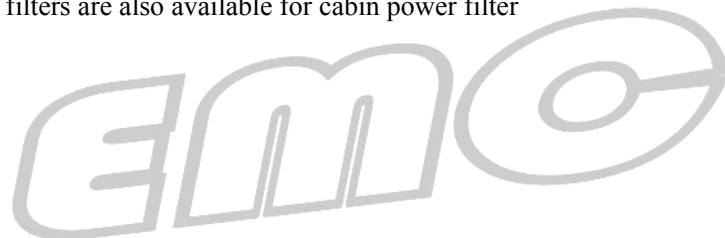

屏蔽室电源滤波器参数表 *Shielding Filter Parameter List*

型 号	数 线	额 定 电 流 (A)	泄 漏 电 流 (A)	插 入 损 耗 (dB)	
				14kHz~150kHz	150kHz~10GHz
PBS-1-006A	1	6	≤1.5	70 ~ 100	≥100
PBS-1-010A	1	10	≤1.5	70 ~ 100	≥100
PBS-1-020A	1	20	≤1.5	70 ~ 100	≥100
PBS-1-030A	1	30	≤1.5	70 ~ 100	≥100
PBS-1-050A	1	50	≤1.5	70 ~ 100	≥100
PBS-1-080A	1	80	≤2.0	70 ~ 100	≥100
PBS-1-100A	1	100	≤2.5	70 ~ 100	≥100
PBS-1-150A	1	150	≤3.0	70 ~ 100	≥100

外形尺寸

Housing and Dimensions

型 号	A	B	C	D	E	F	G	H	I
PBS-1-006A	220	120	70	50	16	15	235	250	80
PBS-1-010A	220	120	70	50	16	15	235	250	80
PBS-1-020A	450	85	85	50	12	30	470	490	50
PBS-1-030A	500	110	110	50	16	40	520	540	70
PBS-1-050A	520	110	110	50	16	40	520	540	70
PBS-1-080A	600	130	130	60	24	40	620	640	80
PBS-1-100A	600	130	130	60	24	40	620	640	80
PBS-1-150A	650	150	140	60	24	40	670	690	90

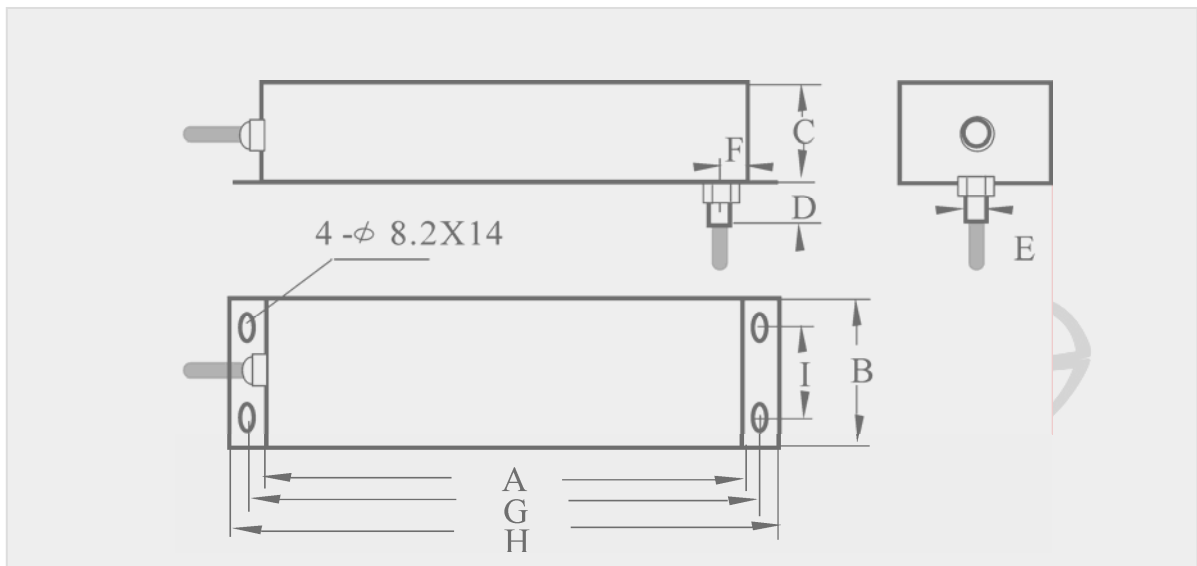

外形尺寸版

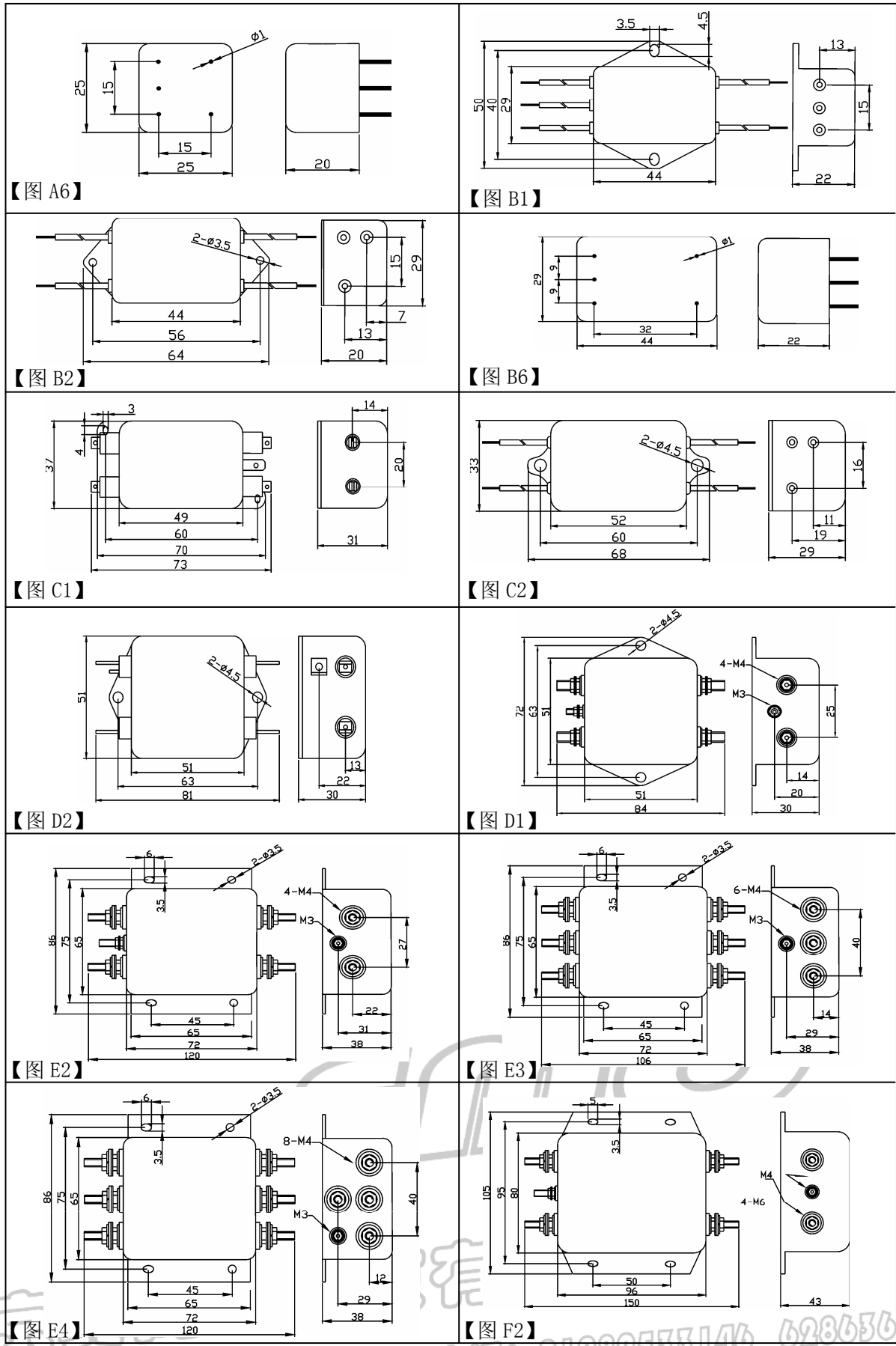

外形尺寸版

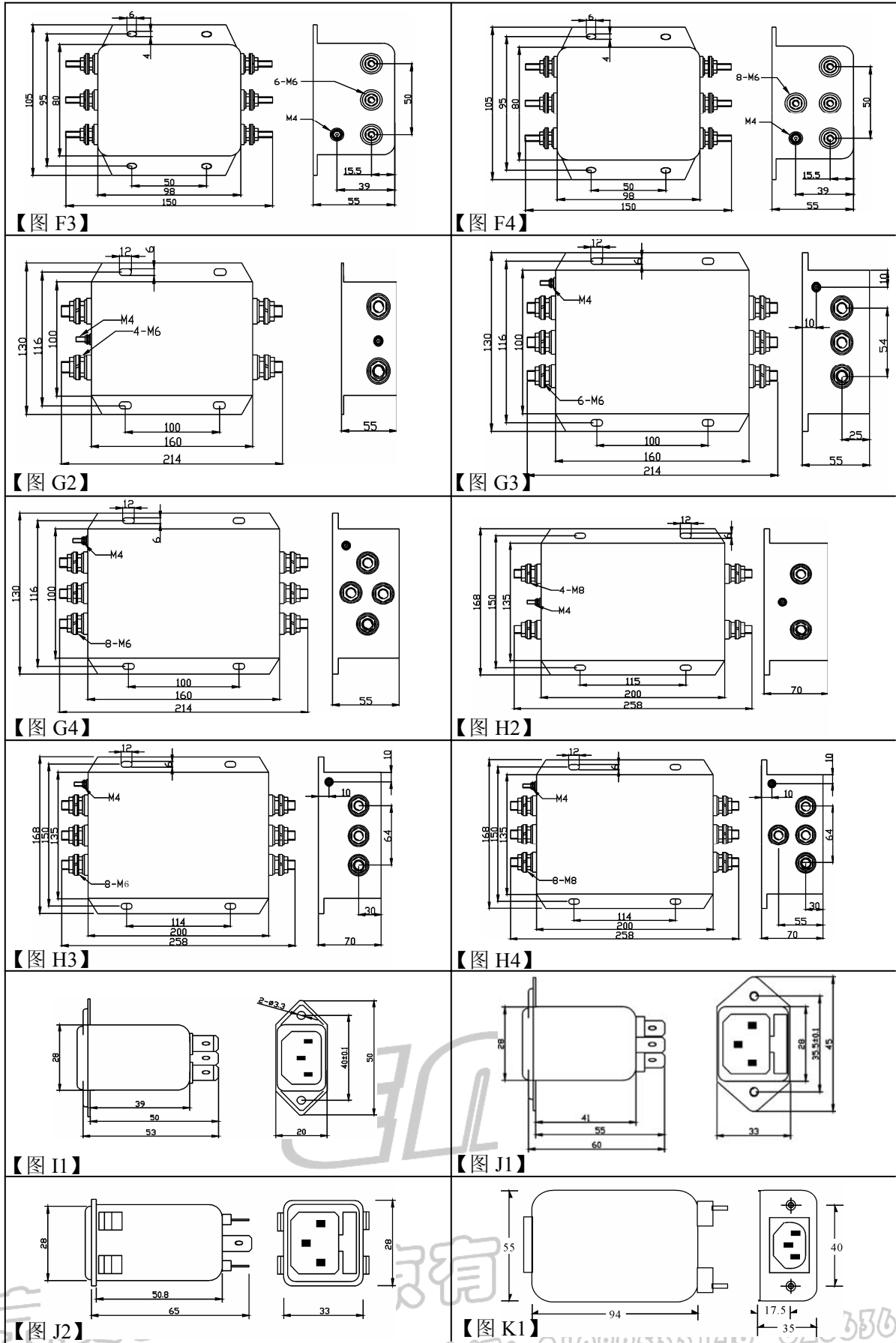

外形尺寸版

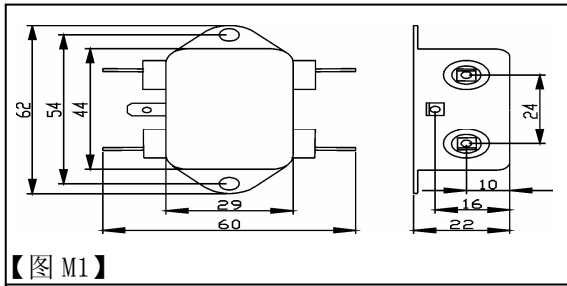

【图 M1】

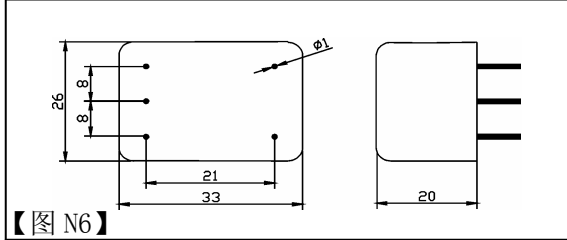

【图 N6】

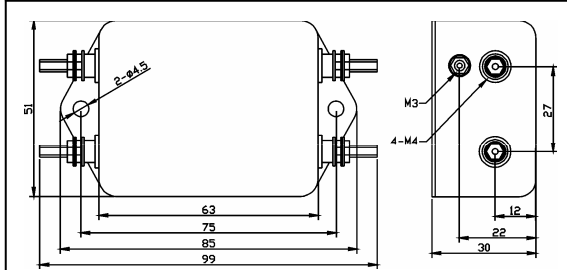

【图 P1】

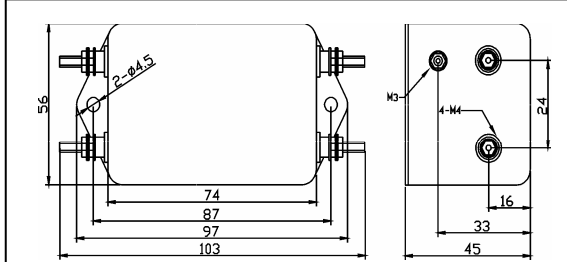

【图 S1】

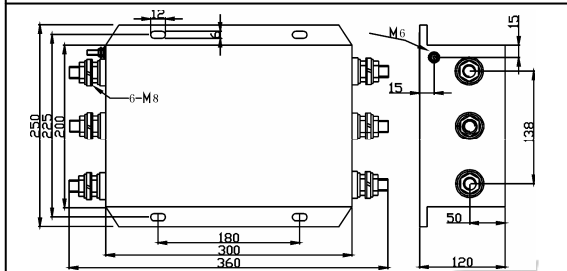

【图 Z3】

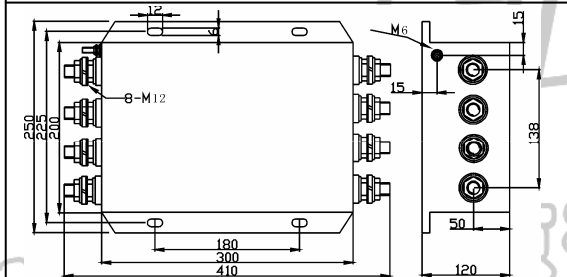

【图 Z4】

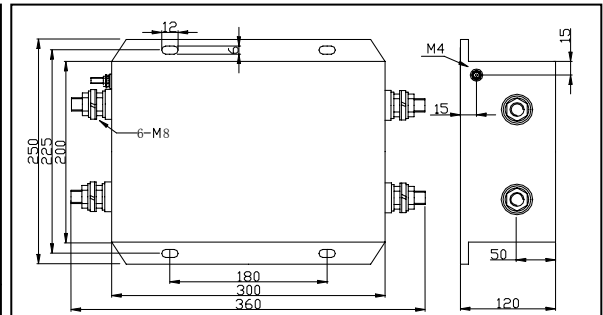

【图 Z2】

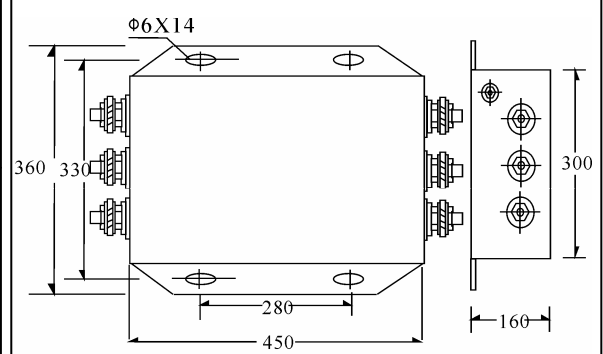

【图 L3】

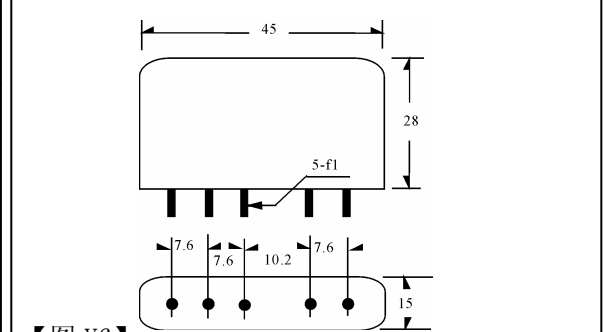

【图 Y6】

EMI 电源滤波器基本知识介绍

1. 概念

电磁干扰 (EMI) 电源滤波器是由电感、电容组成的无源器件。实际上它是一种低通滤波器，让工频 (50/60Hz) 无阻挡的通过，抑制高频电磁干扰 (一般来讲，可抑制干扰噪声频率为 10kHz~30MHz)。EMI 电源滤波器为双向可逆器件，即能防止电网上的电磁噪声通过电源进入设备，也能防止设备本身的电磁噪声对电网的污染。EMI 电源滤波器是用来抑制传导干扰的有效工具。

2. EMI 电源滤波器部分技术参数简介

(a) 插入损耗

插入损耗是衡量 EMI 电源滤波器电性能的重要参数，用下式表示：

$$IL = 20 \log \frac{E_0}{E} \quad (\text{dB})$$

式中：

E_0 ——不加滤波器时，负载上的干扰噪声电压。

E ——接入滤波器后，同一负载上的干扰噪声电压。

干扰方式有共模干扰和差模干扰两种，其定义为：

共模干扰 —— 叠加于相线 (P)、零线 (N) 和地线 (E) 之间的干扰电压。

差模干扰 —— 叠加于相线 (P) 和零线 (N) 之间的干扰电压。

因此插入损耗又分为共模插入损耗和差模插入损耗，插入损耗的测试原理图如下：

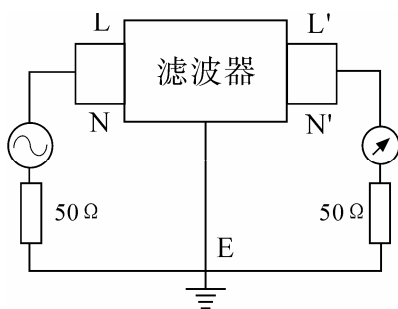

共模插入损耗测试原理图

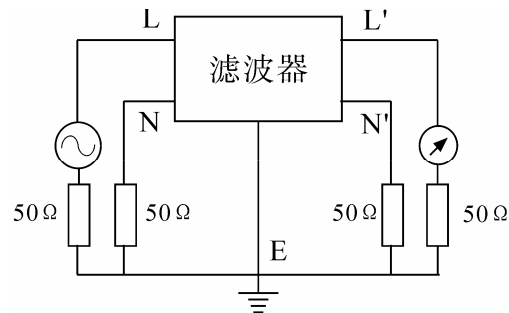

差模插入损耗测试原理图

(b) 泄漏电流

滤波器的泄漏电流是指在 250VAC/50Hz 的电压 / 频率条件下，火线和零线与外壳间流过的电流。它主要取决于滤波器中的共模电容。从插入损耗考虑，共模电容越大，电性能越好，此时，漏电流也越大。但从安全方面考虑，泄漏电流又不能过大，否则不符合安全标准要求。尤其是一些医疗保健设备，要求泄漏电流尽可能小。因此，要根据具体设备要求来确定共模电容的容量。泄漏电流测试电路如下图所示：

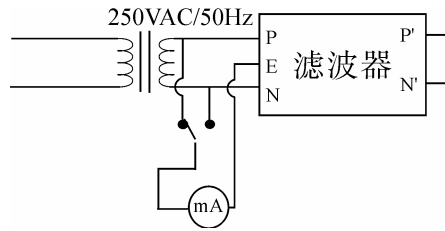

泄漏电流测试电路

(c) 耐压测试:

为确保（交流）电源滤波器的质量，出厂前全部进行耐压测试。测试标准为：

火线与地线（或零线与地线）之间施加频率为 50Hz 的 1500VAC 高压，时间一分钟，不发生放电现象和滋滋声。

火线与零线之间施加 1450VDC 直流高压，时间一分钟，不发生放电现象和滋滋声。

3. EMI 电源滤波器的选用

根据设备的额定工作电压、电流和频率来确定滤波器的类型。滤波器的额定电流不要取的过小，否则会损坏滤波器或降低滤波器的寿命。但额定电流也不要取的过大，因为电流大会增大滤波器的体积或降低滤波器的电气性能。一般按设备额定电流的 1.2 倍来确定滤波器的额定电流。

根据设备现场干扰源情况，来确定干扰噪声类型，是共模干扰还是差模干扰，这样才能有针对性的选用滤波器。如不能确定干扰类型，可通过实际试探来确定滤波器型号，这种方法往往是一种既实际又有效的方法。

根据设备最大泄漏电流的允许值来选择滤波器，尤其对一些医疗保健设备更是如此。

4. EMI 电源滤波器使用注意事项

- 电源滤波器的安装位置应靠近电源线入口处，尽量缩短引线长度。
- 确保滤波器外壳与机箱壳良好接触，外壳接地保护。
- 滤波器的输入输出线应拉开距离，切忌并行走线，以免降低滤波器的电性能。
- 滤波器耐压测试标准是（线-地）1500VAC，（线-线）1450VDC，时间一分钟。由于这种测试对内部器件带有一定损伤，用户测试次数不能过多，时间不能过长。否则会降低滤波器的寿命，甚至损坏滤波器。

