

ASMT-Ax00

1W Power LED Light Source



Data Sheet



Lead (Pb) Free
RoHS 6 fully
compliant

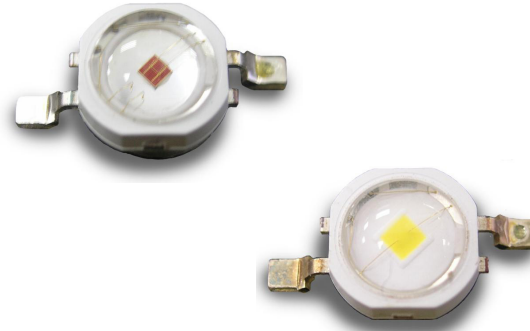

Description

This 1W Power LED Light Source is a high performance energy efficient device which can handle high thermal and high driving current. The exposed pad design enables excellent heat transfer from the package to the motherboard. Option with electrically isolated metal slug is also available.

The White Power LED is available in the range of color temperature from 2700K to 10000K

The low profile package design is suitable for a wide variety of applications especially where height is a constraint.

The package is compatible with reflow soldering process. This part has a foot print that is compatible to most of the high power LED in the market today.

Features

- Available in Red, Amber, Green, Blue, Cool White, Neutral White and Warm White color
- Energy efficient
- Exposed metal slug for excellent heat transfer
- Compatible with reflow soldering process
- High current operation
- Long operation life
- Wide viewing angle at 130°
- Silicone encapsulation
- Non-ESD sensitive (threshold > 16 kV)
- MSL 2a products

Applications

- Architectural lighting
- Channel backlighting
- Contour lighting
- Retail Display lighting
- Decorative lighting
- Garden lighting

Package Dimensions

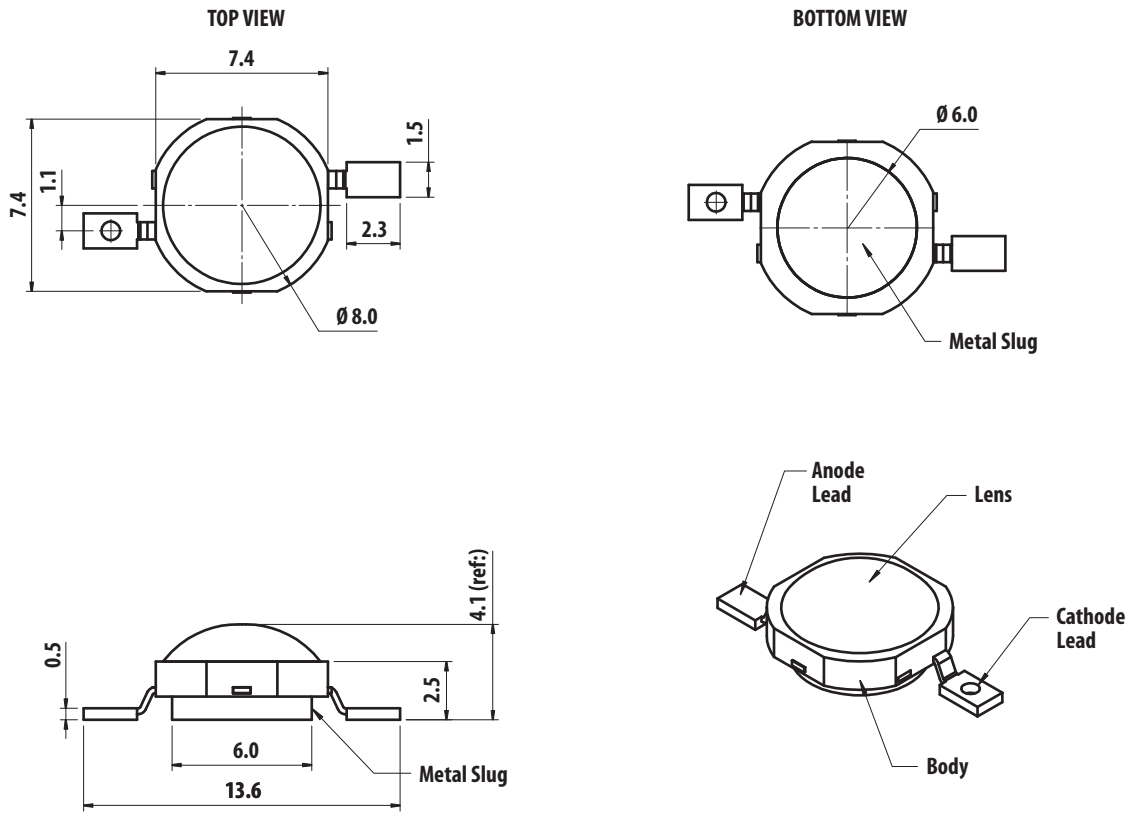

Notes:

1. All dimensions in millimeters.
2. Metal slug is connected to anode for electrically non-isolated option.

Device Selection Guide ($T_j = 25^\circ\text{C}$)

Color	Part Number	Luminous Flux, $\Phi_V^{[1,2]}$ (lm)			Test Current (mA)	Dice Technology	Electrically Isolated Metal Slug
		Min.	Typ.	Max.			
Red	ASMT-AR00	30.6	40.0	51.7	350	AllInGaP	No ^[3]
Amber	ASMT-AA00	30.6	40.0	51.7	350	AllInGaP	No ^[3]
Blue	ASMT-AB00	8.2	15.0	23.5	350	InGaN	Yes
Green	ASMT-AG00	39.8	55.0	87.4	350	InGaN	Yes
Cool White	ASMT-AW00	39.8	60.0	87.4	350	InGaN	Yes
Neutral White	ASMT-AN00	39.8	60.0	87.4	350	InGaN	Yes
Warm White	ASMT-AY00	39.8	55.0	87.4	350	InGaN	Yes

Notes:

1. Φ_V is the total luminous flux output as measured with an integrating sphere at 25ms mono pulse condition.
2. Flux tolerance is $\pm 10\%$.
3. Electrically isolated metal slug option is also available. Please contact your Avago sale representative.

Part Numbering System

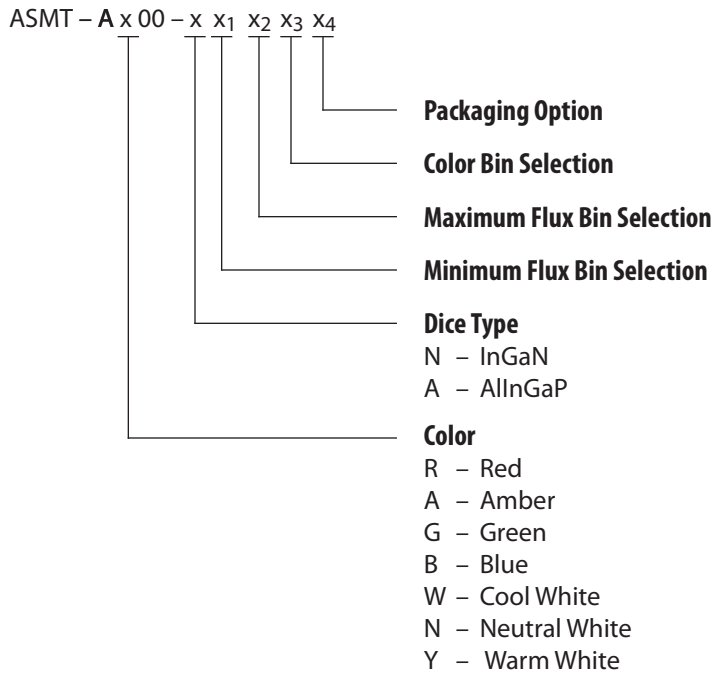

Note:

1. Please refer to Page 6 for selection details.

Absolute Maximum Ratings

Parameter	AllInGaP	InGaN	Units
DC Forward Current ^[1]	350	350	mA
Peak Pulsing Current ^[2]	500	500	mA
Power Dissipation	1085	1400	mW
Reverse Voltage	5	5	V
LED Junction Temperature	125	135	°C
Operating Metal Slug Temperature Range at 350 mA	-40 to +115	-40 to +120	°C
Storage Temperature Range	-40 to +120	-40 to +120	°C
Soldering Temperature	Refer to Figure 20		

Notes:

1. Derate linearly based on Figure. 7 for AllInGaP and Figure. 17 for InGaN.
2. Pulse condition duty factor = 10%, Frequency = 1 kHz.

Optical Characteristics at 350 mA ($T_J = 25^\circ\text{C}$)

Part Number	Color	Peak Wavelength, λ_{PEAK} (nm)	Dominant Wavelength, λ_D [1] (nm)	Viewing Angle, $2\theta_{1/2}$ [2] (°)	Luminous Efficiency (lm/W)
		Typ.	Typ.	Typ.	Typ.
ASMT-AR00	Red	635	625	130	48
ASMT-AA00	Amber	598	590	130	48
ASMT-AG00	Green	519	525	130	44
ASMT-AB00	Blue	460	470	130	12

Part Number	Color	Correlated Color Temperature, CCT (Kelvin)		Viewing Angle, $2\theta_{1/2}$ [2] (°)	Luminous Efficiency (lm/W)
		Min.	Max.	Typ.	Typ.
ASMT-AW00	Cool White	4500	10000	130	49
ASMT-AN00	Neutral White	3500	4500	130	49
ASMT-AY00	Warm White	2700	3500	130	45

Notes:

1. The dominant wavelength, λ_D , is derived from the CIE Chromaticity Diagram and represents the color of the device.
2. $\theta_{1/2}$ is the off-axis angle where the luminous intensity is $1/2$ the peak intensity.

Electrical Characteristic at 350 mA ($T_J = 25^\circ\text{C}$)

Dice Type	Forward Voltage, V_F (Volts) at $I_F = 350\text{mA}$			Thermal Resistance, $R_{\theta_{j-ms}}$ (°C/W) [1]
	Min.	Typ.	Max.	Typ.
AllnGaP	1.9	2.4	3.1	10
InGaN	2.8	3.5	4.0	10

Notes:

1. $R_{\theta_{j-ms}}$ is Thermal Resistance from LED junction to metal slug.

AlInGaP

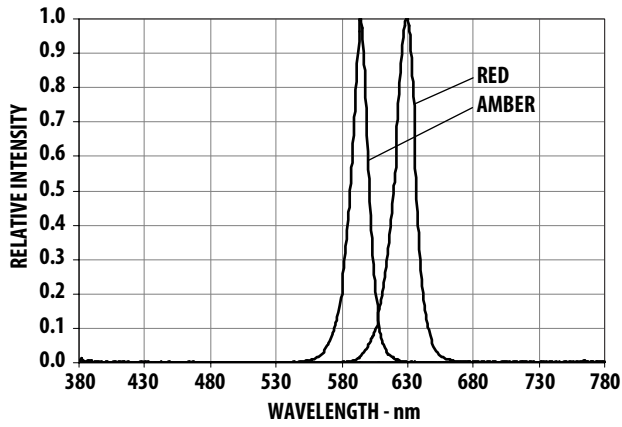

Figure 1. Relative Intensity vs. Wavelength.

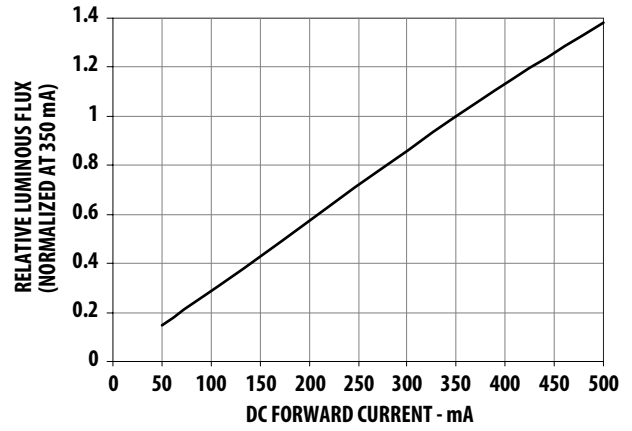

Figure 2. Relative Luminous Flux vs. Mono Pulse Current.

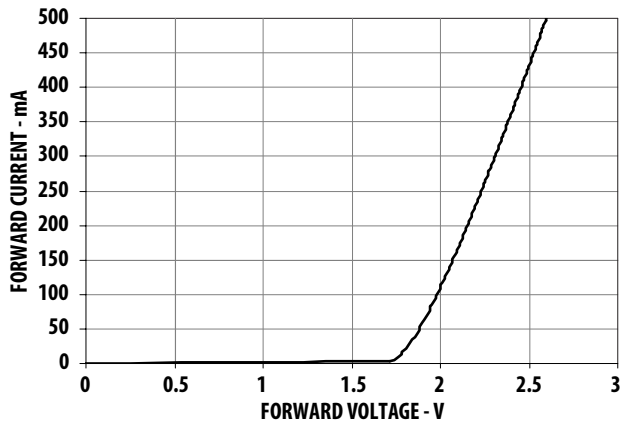

Figure 3. Forward Current vs. Forward Voltage.

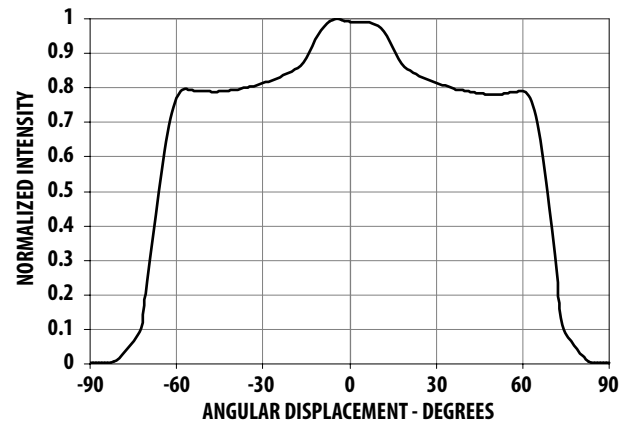

Figure 4. Radiation Pattern Red and Amber.

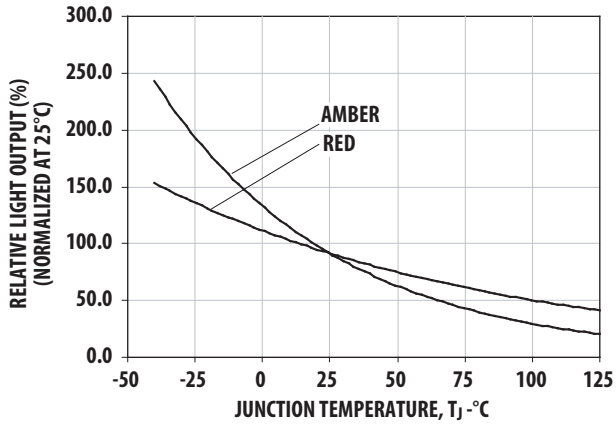

Figure 5. Relative Light Output vs. Junction Temperature.

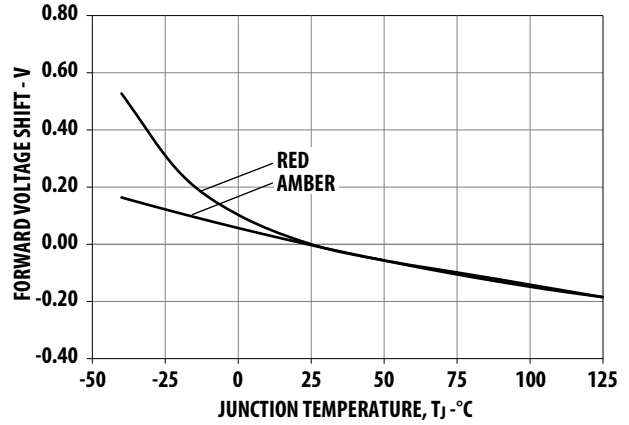

Figure 6. Forward Voltage Shift vs. Junction Temperature.

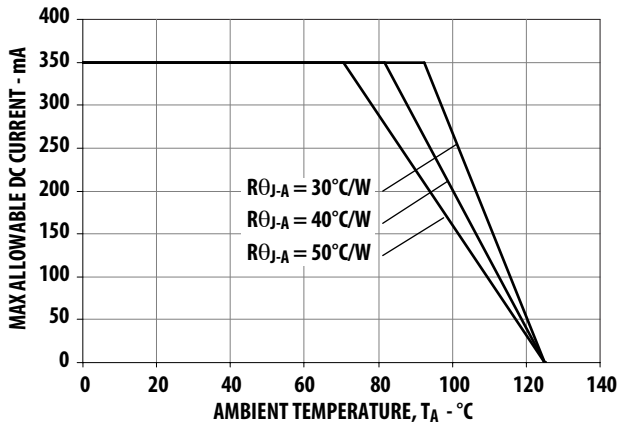

Figure 7. Maximum Forward Current vs. Ambient Temperature.
Derated based on $T_{JMAX} = 125^{\circ}C$, $R_{\theta J-A} = 30^{\circ}C/W$, $40^{\circ}C/W$ and $50^{\circ}C/W$.

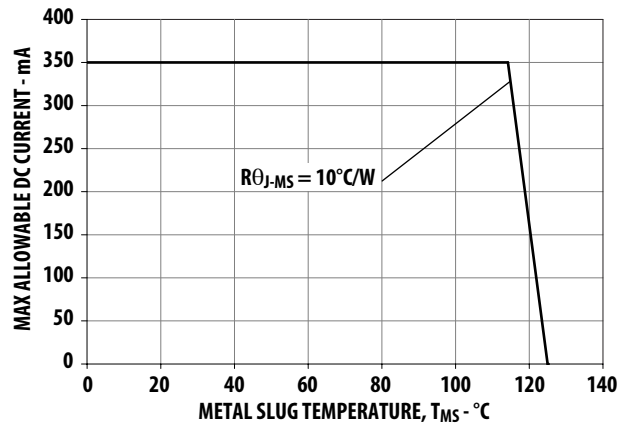

Figure 8. Maximum Forward Current vs. Metal Slug Temperature.
Derated based on $T_{JMAX} = 125^{\circ}C$, $R_{\theta J-MS} = 10^{\circ}C/W$.

InGaN

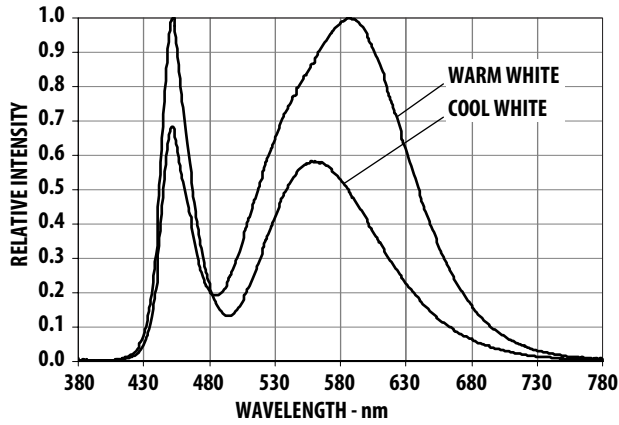

Figure 9. Relative Intensity vs. Wavelength for Cool and Warm White.

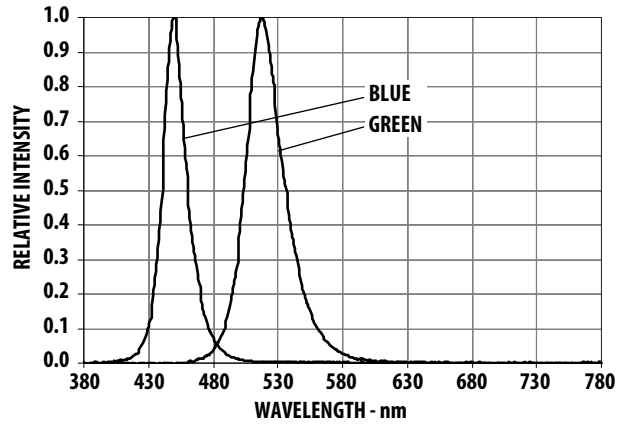

Figure 10. Relative Intensity vs. Wavelength for Blue and Green.

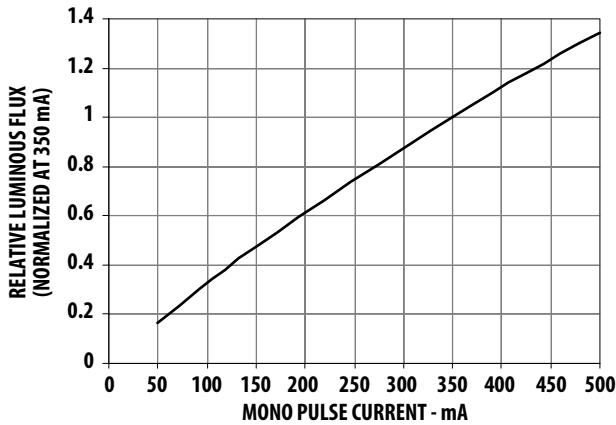

Figure 11. Relative Luminous Flux vs. Mono Pulse Current.

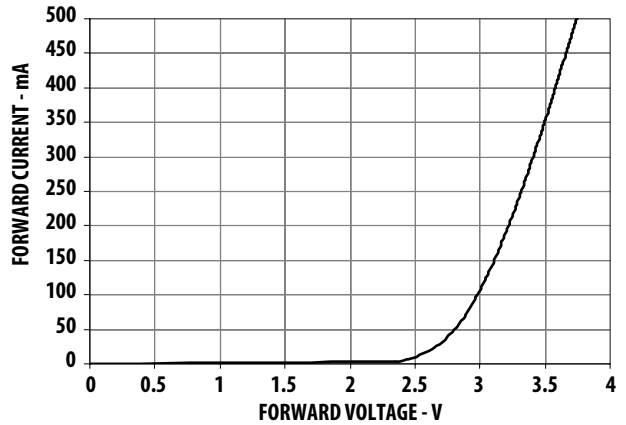

Figure 12. Forward Current vs. Forward Voltage.

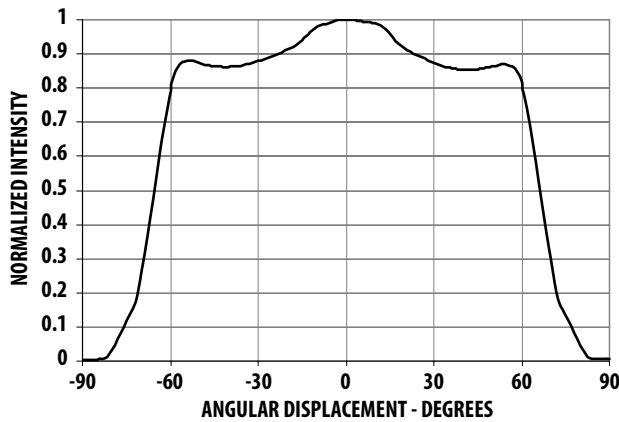

Figure 13. Radiation Pattern for Blue and Green.

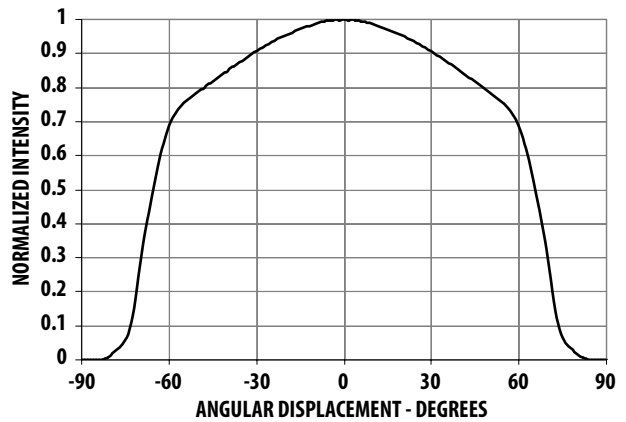

Figure 14. Radiation Pattern for Cool White, Neutral White and Warm White.

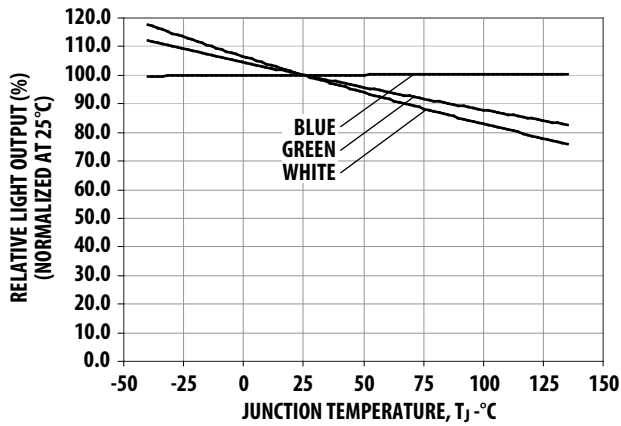

Figure 15. Relative Light Output vs. Junction Temperature.

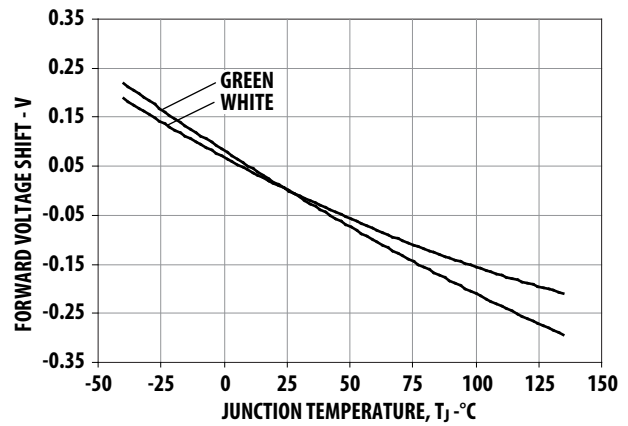

Figure 16. Forward Voltage Shift vs. Junction Temperature.

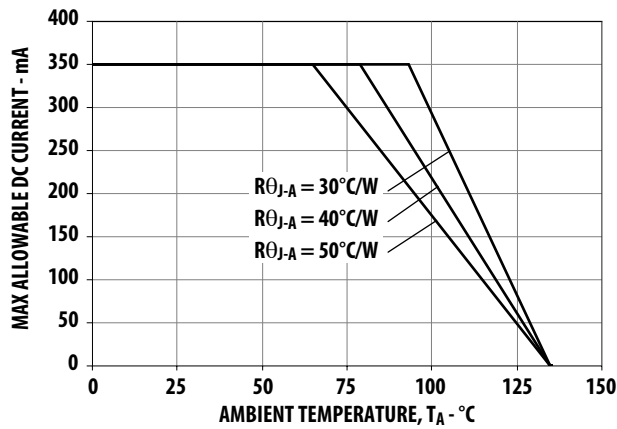

Figure 17: Maximum Forward Current vs. Ambient Temperature. Derated based on $T_{JMAX} = 135^{\circ}C$, $R_{\theta J-A} = 30^{\circ}C/W$, $40^{\circ}C/W$ and $50^{\circ}C/W$.

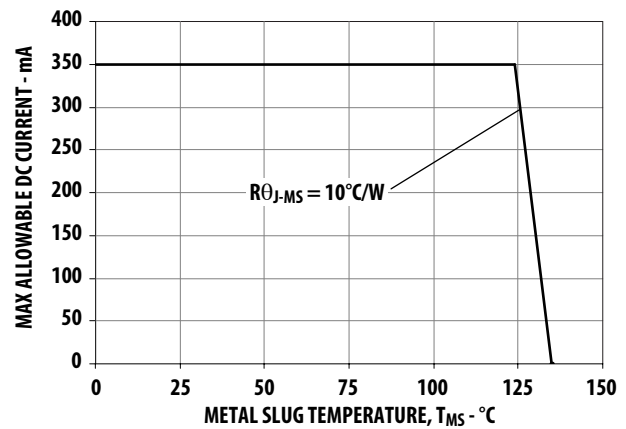

Figure 18: Maximum Forward Current vs. Metal Slug Temperature. Derated based on $T_{JMAX} = 135^{\circ}C$, $R_{\theta J-MS} = 10^{\circ}C/W$.

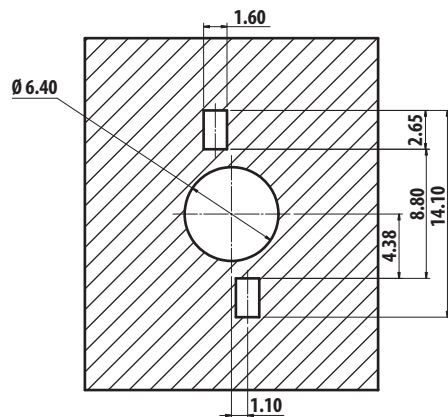

Figure 19. Recommended soldering land pattern.

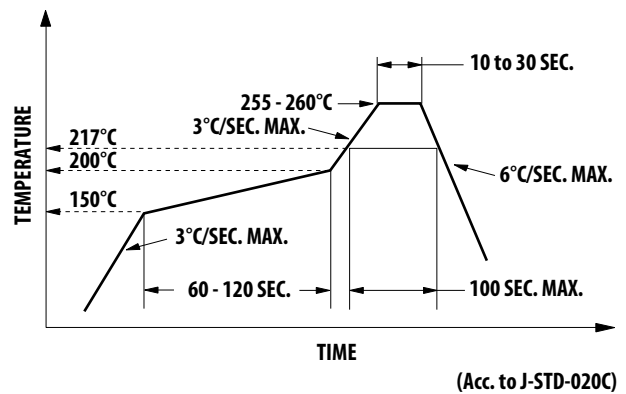

Figure 20. Recommended Reflow Soldering. (Acc. to J-STD-020C)

Note:

For detail information on reflow soldering of Avago surface mount LEDs, do refer to Avago Application Note AN1060 Surface Mounting SMT LED Indicator Components.

Option Selection Details

ASMT-Ax00 – x x₁ x₂ x₃ x₄

x₁ – Minimum Flux Bin Selection

x₂ – Maximum Flux Bin Selection

x₃ – Color Bin Selection

x₄ – Packaging Option

Flux Bin Limit [x₁ x₂]

Color	Bin ID	Luminous Flux (lm) at 350 mA	
		Min.	Max.
Blue	K	8.2	10.7
	L	10.7	13.9
	M	13.9	18.1
	N	18.1	23.5
Other Colors	Q	30.6	39.8
	R	39.8	51.7
	S	51.7	67.2
	T	67.2	87.4

Tolerance for each bin limits is ±10%

Color Bin Selection [x₃]

Individual reel will contain parts from one full bin only.

Cool White

0	Full Distribution
E	VM, UM, VN and UN
F	WM, VM, WN and VN
G	XM, WM, XN and WN
H	UN, VN, U0 and V0
J	WN, VN, W0 and V0
K	XN, WN, X0 and W0
L	V0, U0, VP and UP
M	W0, V0, WP, VP and WQ
N	X0, W0, XP, WP and WQ
P	Y0
Q	YA

Warm White

0	Full Distribution
E	NM, MM, N1 and M1
F	PM, NM, P1 and N1
G	QM, PM, Q1 and P1
H	M1, N1, M0 and N0
J	P1, N1, P0 and N0
K	Q1, P1, Q0 and P0
L	N0, M0, NA and MA
M	P0, N0, PA and NA
N	Q0, P0, QA and PA

Neutral White

0	Full Distribution
E	SM, RM, S1 and R1
F	TM, SM, TN and S1
G	S1, R1, S0 and R0
H	TN, S1, T0 and S0
J	S0, R0, SA and RA
K	T0, S0, TP and SA

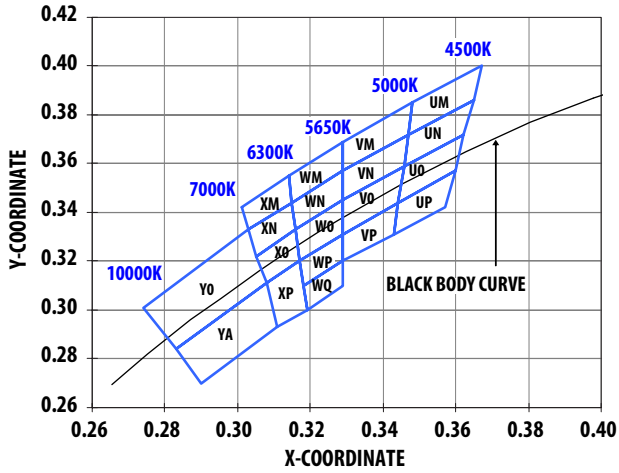

Figure 21. Color bin structure for Cool White.

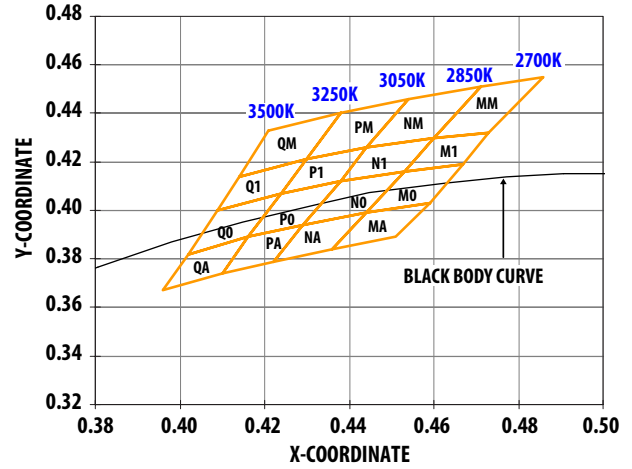

Figure 22. Color bin structure for Warm White.

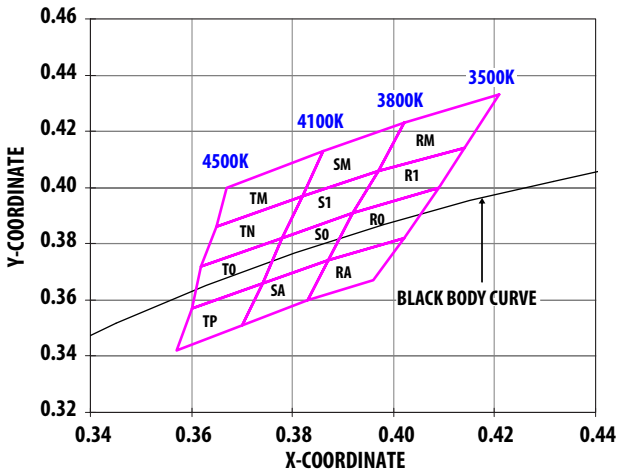

Figure 23. Color bin structure for Neutral White.

Color Bin Limit

Cool White		Color Limits (Chromaticity Coordinates)			
		X	Y	Z	u'
Bin UM	X	0.365	0.367	0.348	0.347
	Y	0.385	0.400	0.385	0.372
Bin UN	X	0.365	0.362	0.346	0.347
	Y	0.386	0.372	0.359	0.372
Bin UO	X	0.362	0.360	0.344	0.346
	Y	0.372	0.357	0.344	0.359
Bin UP	X	0.360	0.357	0.343	0.344
	Y	0.357	0.342	0.311	0.344
Bin VM	X	0.329	0.329	0.348	0.347
	Y	0.357	0.369	0.385	0.372
Bin VN	X	0.329	0.329	0.347	0.346
	Y	0.345	0.357	0.372	0.359
Bin VO	X	0.329	0.329	0.346	0.344
	Y	0.311	0.345	0.359	0.344
Bin VP	X	0.329	0.344	0.343	0.329
	Y	0.331	0.344	0.331	0.320
Bin WM	X	0.329	0.329	0.315	0.314
	Y	0.369	0.357	0.344	0.355
Bin WN	X	0.329	0.316	0.315	0.329
	Y	0.345	0.333	0.344	0.357
Bin WO	X	0.329	0.329	0.317	0.316
	Y	0.345	0.331	0.320	0.333
Bin WP	X	0.329	0.329	0.318	0.317
	Y	0.331	0.320	0.310	0.320
Bin WQ	X	0.329	0.329	0.319	0.318
	Y	0.320	0.310	0.300	0.310
Bin XM	X	0.301	0.314	0.315	0.303
	Y	0.342	0.355	0.344	0.333
Bin XN	X	0.305	0.303	0.315	0.316
	Y	0.322	0.333	0.344	0.333
Bin XO	X	0.308	0.305	0.316	0.317
	Y	0.311	0.322	0.333	0.320
Bin XP	X	0.308	0.317	0.319	0.311
	Y	0.311	0.320	0.300	0.293
Bin YO	X	0.308	0.283	0.274	0.303
	Y	0.311	0.284	0.301	0.333
Bin YA	X	0.308	0.311	0.290	0.283
	Y	0.311	0.293	0.270	0.284

Tolerance: ± 0.01

Warm White		Color Limits (Chromaticity Coordinates)			
		X	Y	Z	u'
Bin MM	X	0.471	0.460	0.473	0.486
	Y	0.451	0.430	0.432	0.455
Bin M1	X	0.460	0.453	0.467	0.473
	Y	0.430	0.416	0.419	0.432
Bin M0	X	0.453	0.444	0.459	0.467
	Y	0.416	0.399	0.403	0.419
Bin MA	X	0.459	0.444	0.436	0.451
	Y	0.403	0.399	0.384	0.389
Bin NM	X	0.454	0.444	0.460	0.453
	Y	0.446	0.426	0.430	0.416
Bin N1	X	0.444	0.438	0.453	0.436
	Y	0.426	0.412	0.416	0.384
Bin N0	X	0.438	0.429	0.444	0.460
	Y	0.412	0.394	0.399	0.430
Bin NA	X	0.444	0.429	0.422	0.471
	Y	0.399	0.394	0.379	0.451
Bin PM	X	0.438	0.430	0.444	0.454
	Y	0.440	0.421	0.426	0.446
Bin P1	X	0.430	0.424	0.438	0.444
	Y	0.421	0.407	0.412	0.426
Bin P0	X	0.424	0.416	0.429	0.438
	Y	0.407	0.389	0.394	0.412
Bin PA	X	0.429	0.416	0.410	0.422
	Y	0.394	0.389	0.374	0.379
Bin QM	X	0.421	0.414	0.430	0.438
	Y	0.433	0.414	0.421	0.440
Bin Q1	X	0.414	0.409	0.424	0.430
	Y	0.414	0.400	0.407	0.421
Bin Q0	X	0.409	0.402	0.416	0.424
	Y	0.400	0.382	0.389	0.407
Bin QA	X	0.416	0.402	0.396	0.410
	Y	0.389	0.382	0.367	0.374

Tolerance: ± 0.01

Neutral White	Color Limits (Chromaticity Coordinates)					
		X	Y	Z	u'	v'
Bin RM	X	0.421	0.414	0.397	0.402	
	Y	0.433	0.414	0.406	0.423	
Bin R1	X	0.414	0.409	0.392	0.397	
	Y	0.414	0.400	0.391	0.406	
Bin R0	X	0.392	0.387	0.402	0.409	
	Y	0.391	0.374	0.382	0.400	
Bin RA	X	0.387	0.383	0.396	0.402	
	Y	0.374	0.360	0.367	0.382	
Bin SM	X	0.402	0.397	0.382	0.386	
	Y	0.423	0.406	0.397	0.413	
Bin S1	X	0.397	0.392	0.378	0.382	
	Y	0.406	0.391	0.382	0.397	
Bin S0	X	0.392	0.387	0.374	0.378	
	Y	0.391	0.374	0.366	0.382	
Bin SA	X	0.387	0.383	0.370	0.374	
	Y	0.374	0.360	0.351	0.366	
Bin TM	X	0.386	0.382	0.365	0.367	
	Y	0.413	0.397	0.386	0.400	
Bin TN	X	0.382	0.378	0.362	0.365	
	Y	0.397	0.382	0.372	0.386	
Bin T0	X	0.378	0.374	0.360	0.362	
	Y	0.382	0.366	0.357	0.372	
Bin TP	X	0.374	0.370	0.357	0.360	
	Y	0.366	0.351	0.342	0.357	

Tolerance: ± 0.01

Packaging Option [x₄]

Selection	Option
0	Tube
1	Tape and Reel

Color	Bin ID	Min.	Max.
Red	-	620.0	635.0
Amber	A	584.5	587.0
	B	587.0	589.5
	C	589.5	592.0
	D	592.0	594.5
	E	594.5	597.0
Blue	A	460.0	465.0
	B	465.0	470.0
	C	470.0	475.0
	D	475.0	480.0
Green	A	515.0	520.0
	B	520.0	525.0
	C	525.0	530.0
	D	530.0	535.0

Tolerance: ± 1 nm

Example

ASMT-AW00-NRS00

ASMT-AW00-Nxxxx – Cool White, InGaN, Electrically isolated Heat Sink

X1 = R – Minimum Flux Bin R

X2 = S – Maximum Flux Bin S

X3 = 0 – Full Distribution

X4 = 0 – Tube Option

Packing Tube – Option 0

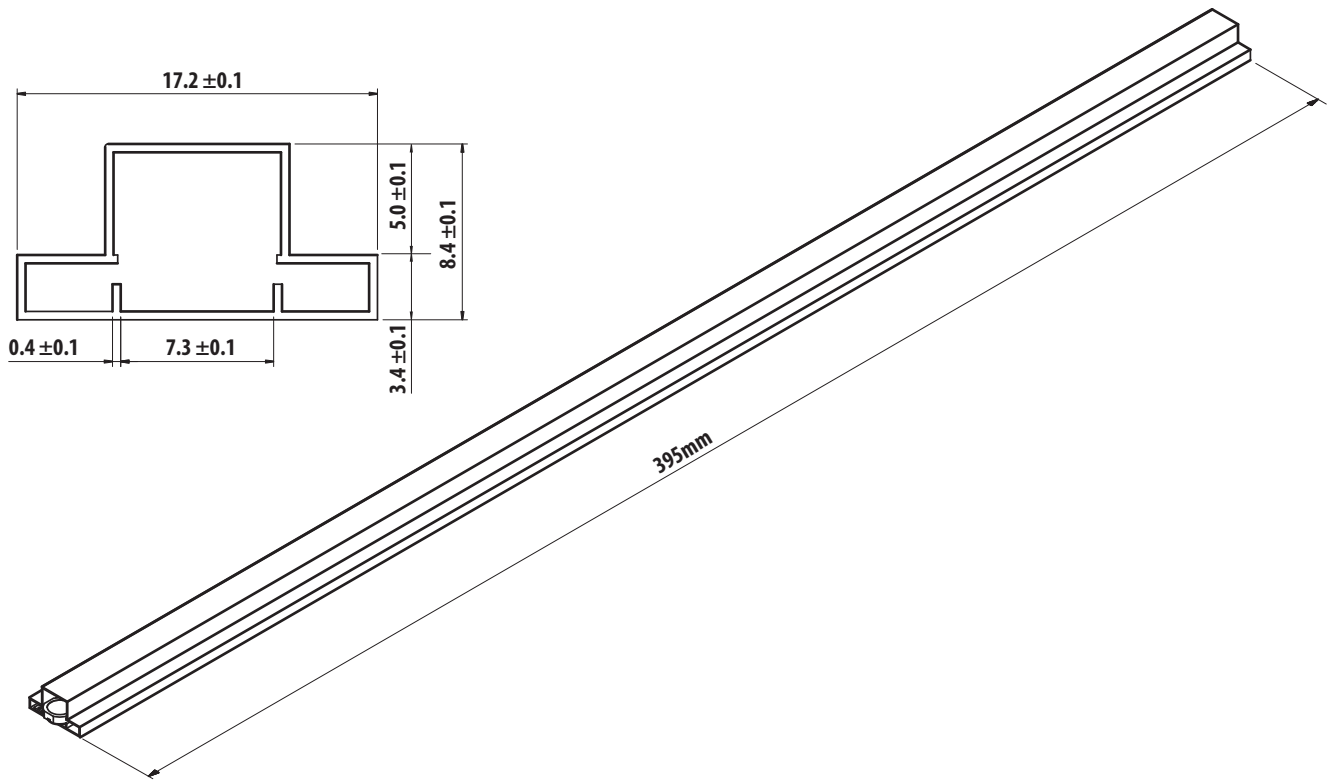

Figure 24. Package tube dimensions.

Tape and Reel – Option 1

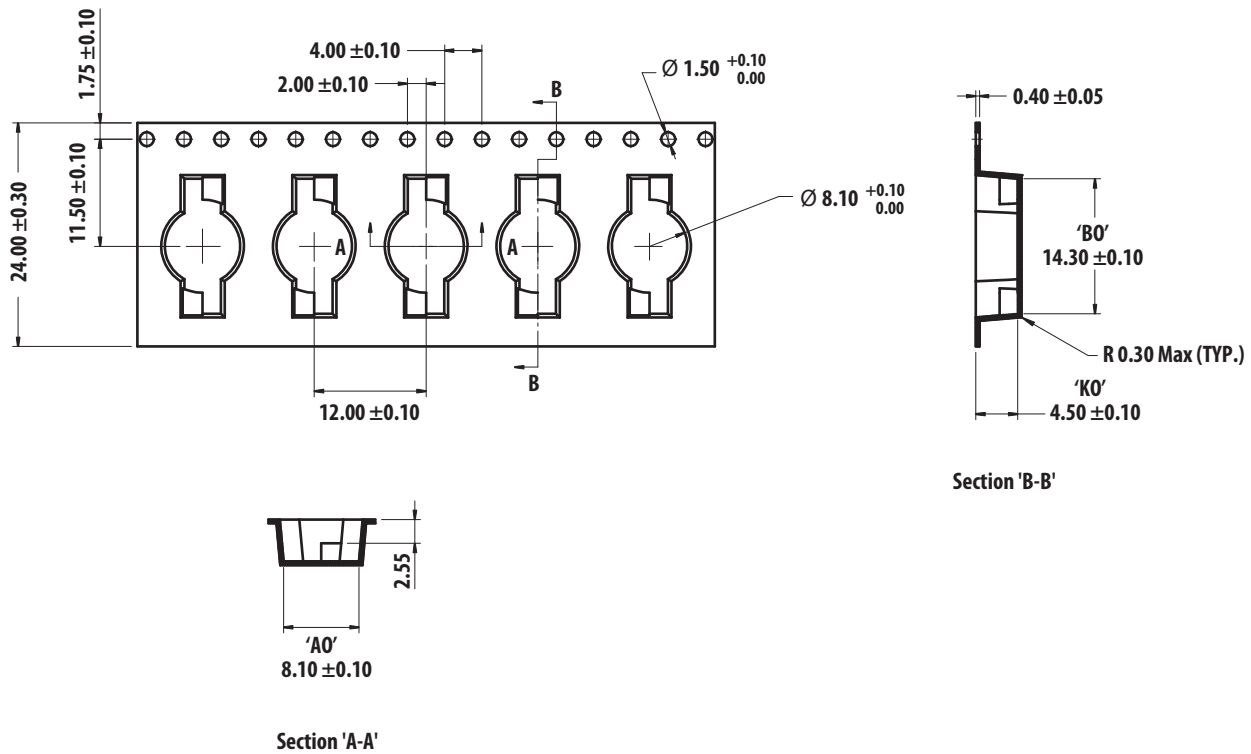

Figure 25. Carrier tape dimensions.

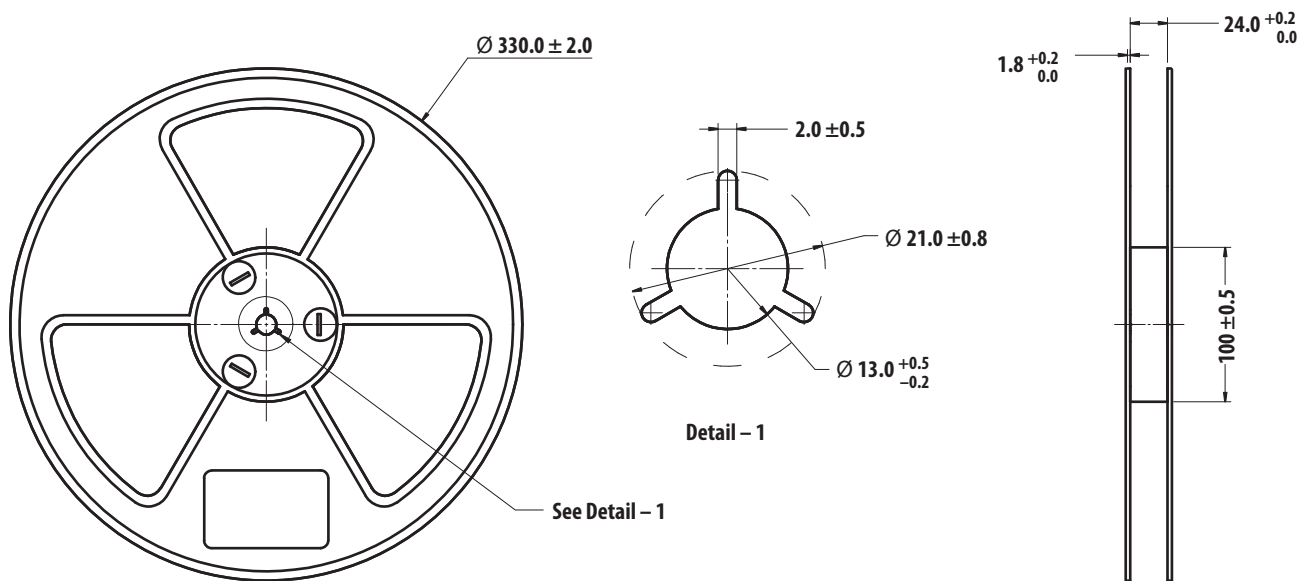

Figure 26. Reel dimensions.

Handling Precaution

The encapsulation material of the product is made of silicone for better reliability of the product. As silicone is a soft material, please do not press on the silicone or poke a sharp object onto the silicone. These might damage the product and cause premature failure. During assembly of handling, the unit should be held on the body only. Please refer to Avago Application Note AN 5288 for detail information.

Moisture Sensitivity

This product is qualified as Moisture Sensitive Level 2a per Jedec J-STD-020. Precautions when handling this moisture sensitive product is important to ensure the reliability of the product. Do refer to Avago Application Note AN5305 Handling of Moisture Sensitive Surface Mount Devices for details.

A. Storage before use

- Unopen moisture barrier bag (MBB) can be stored at $40^{\circ}\text{C}/90\%RH$ for 12 months. If the actual shelf life has exceeded 12 months and the humidity indicator card (HIC) indicates that baking is not required, then it is safe to reflow the LEDs per the original MSL rating.
- It is not recommended to open the MBB prior to assembly (e.g. for IQC).

B. Control after opening the MBB

- The humidity indicator card (HIC) shall be read immediately upon opening of MBB.
- The LEDs must be kept at $30^{\circ}\text{C}/60\%RH$ at all time and all high temperature related process including soldering, curing or rework need to be completed within 672 hours.

C. Control for unfinished reel

- For any unused LEDs, they need to be stored in sealed MBB with desiccant or desiccator at $5\%RH$.

D. Control of assembled boards

- If the PCB soldered with the LEDs is to be subjected to other high temperature processes, the PCB need to be stored in sealed MBB with desiccant or desiccator at $5\%RH$ to ensure no LEDs have exceeded their floor life of 672 hours.

E. Baking is required if:

- "60%" HIC indicator is NOT blue.
- The LEDs are exposed to condition of $30^{\circ}\text{C}/60\%RH$ at any time.
- The LED floor life exceeded 672hrs.

Recommended baking condition: $60\pm 5^{\circ}\text{C}$ for 20hrs.

DISCLAIMER: Avago's products and software are not specifically designed, manufactured or authorized for sale as parts, components or assemblies for the planning, construction, maintenance or direct operation of a nuclear facility or for use in medical devices or applications. Customer is solely responsible, and waives all rights to make claims against avago or its suppliers, for all loss, damage, expense or liability in connection with such use.

For product information and a complete list of distributors, please go to our web site: www.avagotech.com

Avago, Avago Technologies, and the A logo are trademarks of Avago Technologies in the United States and other countries. Data subject to change. Copyright © 2005-2008 Avago Technologies. All rights reserved. AV02-1640EN - December 18, 2008

AVAGO
TECHNOLOGIES