

A Thermoelectric Cooler Temperature Controller for Fiber Optic Lasers

Climatic Pampering for Temperamental Lasers

Jim Williams

INTRODUCTION

Continued demands for increased bandwidth have resulted in deployment of fiber optic-based networks. The fiber optic lines, driven by solid state lasers, are capable of very high information density. Highly packed data schemes such as DWDM (dense wavelength division multiplexing) utilize multiple lasers driving a fiber to obtain large multi-channel data streams. The narrow channel spacing relies on laser wavelength being controlled within 0.1nm (nanometer). Lasers are capable of this but temperature variation influences operation. Figure 1 shows that laser output peaks sharply vs wavelength, implying that laser wavelength must be controlled well within 0.1nm to maintain performance. Figure 2 plots typical laser wavelength vs temperature. The 0.1nm/°C slope means that although temperature facilitates tuning laser wavelength, it must not vary once the laser has been peaked. Typically, temperature control of 0.1°C is required to maintain laser operation well within 0.1nm.

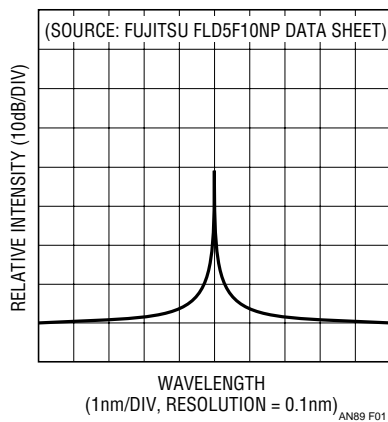

Figure 1. Laser Intensity Peak Approaches 40dB within a 1nm Window

Temperature Controller Requirements

The temperature controller must meet some unusual requirements. Most notably, because of ambient temperature variation and laser operation uncertainties, the controller must be capable of either sourcing or removing heat to maintain control. Peltier-based thermoelectric coolers (TEC) permit this but the controller must be truly bidirectional. Its heat flow control must not have dead zone or untoward dynamics in the “hot-to-cold” transition region. Additionally, the temperature controller must be a precision device capable of maintaining control well inside 0.1°C over time and temperature variations.

Laser based systems packaging is compact, necessitating small solution size with efficient operation to avoid excessive heat dissipation. Finally, the controller must operate from a single, low voltage source and its (presumably switched mode) operation must not corrupt the supply with noise.

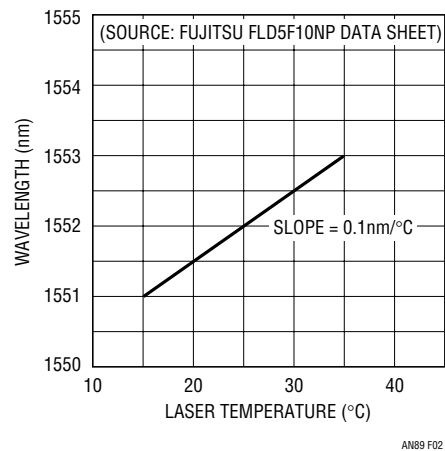

Figure 2. Laser Wavelength Varies $\approx 0.1\text{nm}/^\circ\text{C}$. Typical Application Requires Wavelength Stability within 0.1nm, Mandating Temperature Control

LT, LTC and LT are registered trademarks of Linear Technology Corporation.

Application Note 89

Temperature Controller Details

Figure 3, a schematic of the thermoelectric cooler (TEC) temperature controller, includes three basic sections. The DAC and the thermistor form a bridge, the output of which is amplified by A1. The LTC1923 controller is a pulse width modulator which provides appropriately modulated and phased drive to the power output stage. The laser is an electrically delicate and very expensive load. As such, the controller provides a variety of monitoring, limiting and overload protection capabilities. These include soft-start and overcurrent protection, TEC voltage and current sense and “out-of-bounds” temperature sensing. Aberrant operation results in circuit shutdown, preventing laser module damage. Two other features promote system level compatibility. A phase-locked loop based oscillator permits reliable clock synchronization of multiple LTC1923s in multilaser systems. Finally, the switched mode power delivery to the TEC is efficient but special considerations are required to ensure that switching related noise is not introduced (“reflected”) into the host power supply. The LTC1923 includes edge slew limiting which minimizes

switching related harmonics by slowing down the power stages’ transition times. This greatly reduces high frequency harmonic content, preventing excessive switching related noise from corrupting the power supply or the laser.¹ The switched mode power output stage, an “H-bridge” type, permits efficient bidirectional drive to the TEC, allowing either heating or cooling of the laser. The thermistor, TEC and laser, packaged at manufacture within the laser module, are tightly thermally coupled.

The DAC permits adjusting temperature setpoint to any individual laser’s optimum operating point, normally specified for each laser. Controller gain and bandwidth adjustments optimize thermal loop response for best temperature stability.

Thermal Loop Considerations

The key to high performance temperature control is matching the controller’s gain bandwidth to the thermal feedback path. Theoretically, it is a simple matter to do this using conventional servo-feedback techniques. Practi-

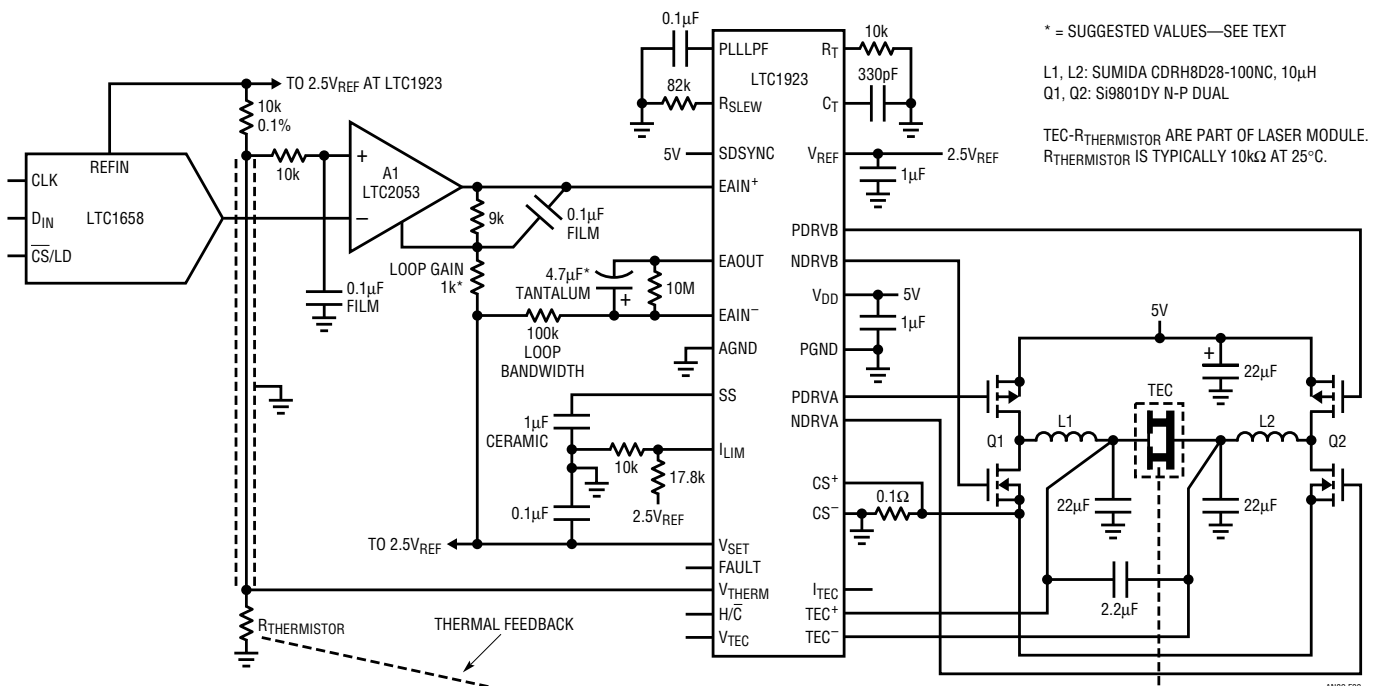

Figure 3. Detailed Schematic of TEC Temperature Controller Includes A1 Thermistor Bridge Amplifier, LTC1923 Switched Mode Controller and Power Output H-Bridge. DAC Establishes Temperature Setpoint. Gain Adjust and Compensation Capacitor Optimize Loop Gain Bandwidth. Various LTC1923 Outputs Permit Monitoring TEC Operating Conditions

Note 1: This technique derives from earlier efforts. See Reference 1 for detailed discussion and related topics.

cally, the long time constants and uncertain delays inherent in thermal systems present a challenge. The unfortunate relationship between servo systems and oscillators is very apparent in thermal control systems.

The thermal control loop can be very simply modeled as a network of resistors and capacitors. The resistors are equivalent to the thermal resistance and the capacitors to thermal capacity. In Figure 4 the TEC, TEC-sensor interface and sensor all have RC factors that contribute to a lumped delay in the system's ability to respond. To prevent oscillation, gain bandwidth must be limited to account for this delay. Since high gain bandwidth is desirable for good control, the delays should be minimized. This is presumably addressed by the laser module's purveyor at manufacture.

The model also includes insulation between the controlled environment and the uncontrolled ambient. The function of insulation is to keep the loss rate down so the temperature control device can keep up with the losses. For any given system, the higher the ratio between the TEC-sensor time constants and the insulation time constants, the better the performance of the control loop.²

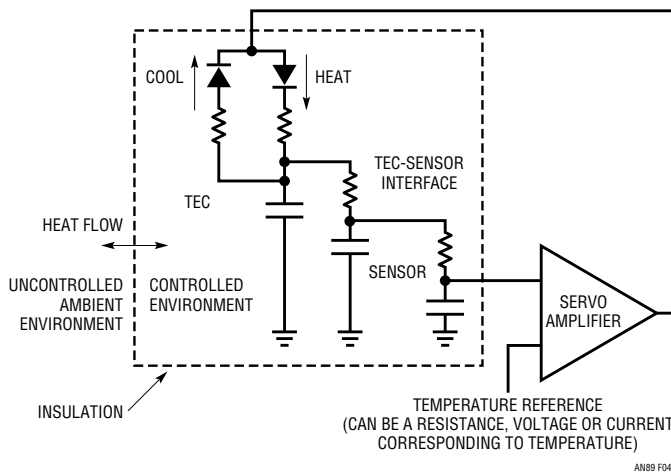

Figure 4. Simplified TEC Control Loop Model Showing Thermal Terms. Resistors and Capacitors Represent Thermal Resistance and Capacity, Respectively. Servo Amplifier Gain Bandwidth Must Accommodate Lumped Delay Presented by Thermal Terms to Avoid Instability

Temperature Control Loop Optimization

Temperature control loop optimization begins with thermal characterization of the laser module. The previous section emphasized the importance of the ratio between the TEC-sensor and insulation time constants. Determination of this information places realistic bounds on achievable controller gain bandwidth. Figure 5 shows results when a typical laser module is subjected to a 40°C step change in ambient temperature. The laser module's internal temperature, monitored by its thermistor, is plotted vs time with the TEC unpowered. An ambient-to-sensor lag measured in minutes shows a classic first order response.

The TEC-sensor lumped delay is characterized by operating the laser module in Figure 3's circuit with gain set at maximum and no compensation capacitor installed. Figure 6 shows large-signal oscillation due to thermal lag dominating the loop. A great deal of valuable information is contained in this presentation.³ The frequency, primarily determined by TEC-sensor lag, implies limits on how much loop bandwidth is achievable. The high ratio of this frequency to the laser module's thermal time constant (Figure 5) means a simple, dominant pole loop compen-

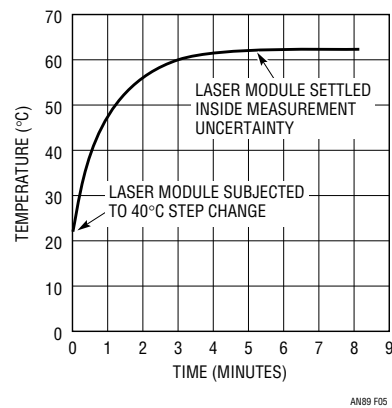

Figure 5. Ambient-to-Sensor Lag Characteristic for a Typical Laser Module Is Set by Package Thermal Resistance and Capacity

Note 2: For the sake of text flow, this somewhat academic discussion must suffer brevity. However, additional thermodynamic gossip appears in Appendix A, "Practical Considerations in Thermoelectric Cooler Based Control Loops."

Note 3: When a circuit "doesn't work" because "it oscillates," whether at millihertz or gigahertz, four burning questions should immediately dominate the pending investigation. What frequency does it oscillate at, what is the amplitude, duty cycle and waveshape? The solution invariably resides in the answers to these queries. Just stare thoughtfully at the waveform and the truth will bloom.

Application Note 89

sation will be effective. The saturation limited waveshape suggests excessive gain is driving the loop into full cooling and heating states. Finally, the asymmetric duty cycle reflects the TEC's differing thermal efficiency in the cooling and heating modes.

Controller gain bandwidth reduction from Figure 6's extremes produced Figure 7's display. The waveform results from a small step ($\approx 0.1^\circ\text{C}$) change in temperature setpoint. Gain bandwidth is still excessively high, producing a damped, ringing response over 2 minutes in duration! The loop is just marginally stable. Figure 8's test conditions are identical but gain bandwidth has been significantly reduced. Response is still not optimal but settling occurs in

≈ 4.5 seconds, about 25x faster than the previous case. Figure 9's response, taken at further reduced gain bandwidth settings, is nearly critically damped and settles cleanly in about 2 seconds. A laser module optimized in this fashion will easily attenuate external temperature shifts by a factor of thousands without overshoots or excessive lags. Further, although there are substantial thermal differences between various laser modules, some generalized guidelines on gain bandwidth values are possible.⁴ A DC gain of 1000 is sufficient for required temperature control, with bandwidth below 1 Hz providing adequate loop stability. Figure 3's suggested gain and bandwidth values reflect these conclusions, although stability testing for any specific case is mandatory.

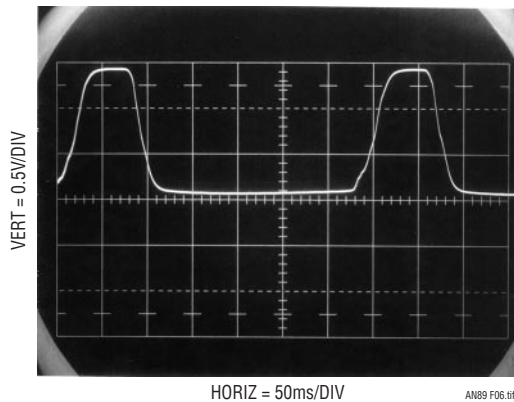

Figure 6. Deliberate Excess of Loop Gain Bandwidth Introduces Large-Signal Oscillation. Oscillation Frequency Provides Guidance for Achievable Closed-Loop Bandwidth. Duty Cycle Reveals Asymmetric Heating-Cooling Mode Gains

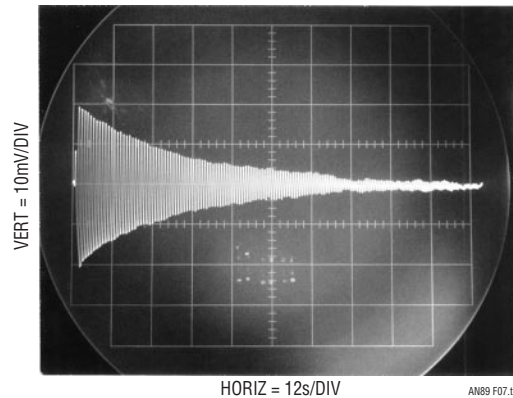

Figure 7. Loop Response to Small Step in Temperature Setpoint. Gain Bandwidth Is Excessively High, Resulting in Damped, Ringing Response Over 2 Minutes in Duration

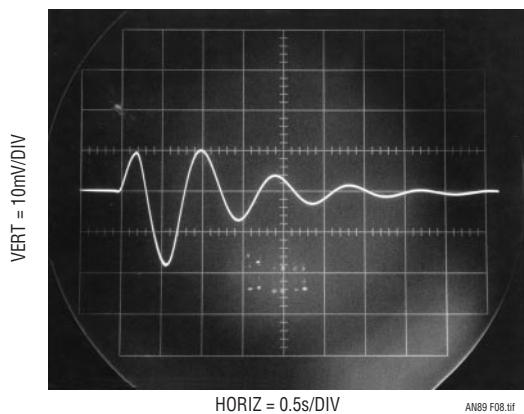

Figure 8. Same Test Conditions as Figure 7 but at Reduced Loop Gain Bandwidth. Loop Response Is Still Not Optimal but Settling Occurs in 4.5 Seconds—Over 25x Faster than Previous Case

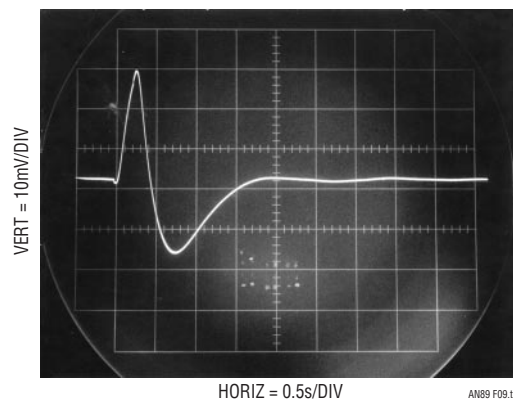

Figure 9. Gain Bandwidth Optimization Results in Nearly Critically Damped Response with Settling in 2 Seconds

Note 4: See Appendix A, "Practical Considerations in Thermoelectric Cooler Based Control Loops," for additional comment.

Temperature Stability Verification

Once the loop has been optimized, temperature stability can be measured. Stability is verified by monitoring thermistor bridge offset with a stable, calibrated differential amplifier.⁵ Figure 10 records ± 1 millidegree baseline stability over 50 seconds in the cooling mode. A more stringent test measures longer term stability with significant variations in ambient temperature. Figure 11's strip-chart recording measures cooling mode stability against an environment that steps 20°C above ambient every hour over 9 hours.⁶ The data shows 0.008°C resulting variation,

indicating a thermal gain of 2500.⁷ The 0.0025°C baseline tilt over the 9 hour plot length derives from varying ambient temperature. Figure 12 utilizes identical test conditions, except that the controller operates in the heating mode. The TEC's higher heating mode efficiency furnishes greater thermal gain, resulting in a 4x stability improvement to about 0.002°C variation. Baseline tilt, just detectable, shows a similar 4x improvement vs Figure 11.

This level of performance ensures the desired stable laser characteristics. Long-term (years) temperature stability is primarily determined by thermistor aging characteristics.⁸

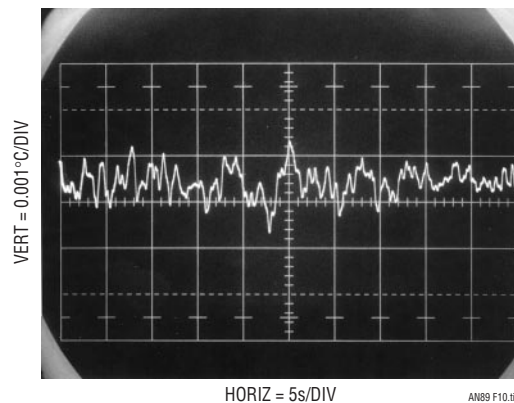

Figure 10. Short-Term Monitoring in Room Environment Indicates 0.001°C Cooling Mode Baseline Stability

Note 5: This measurement monitors thermistor stability. Laser temperature stability will be somewhat different due to slight thermal decoupling and variations in laser power dissipation. See Appendix A.

Note 6: That's right, a *strip-chart recording*. Stubborn, locally based aberrants persist in their use of such archaic devices, forsaking more modern alternatives. Technical advantage could account for this choice, although deeply seated cultural bias may be a factor.

Note 7: Thermal gain is temperature control aficionado jargon for the ratio of ambient-to-controlled temperature variation.

Note 8: See Appendix A for additional information.

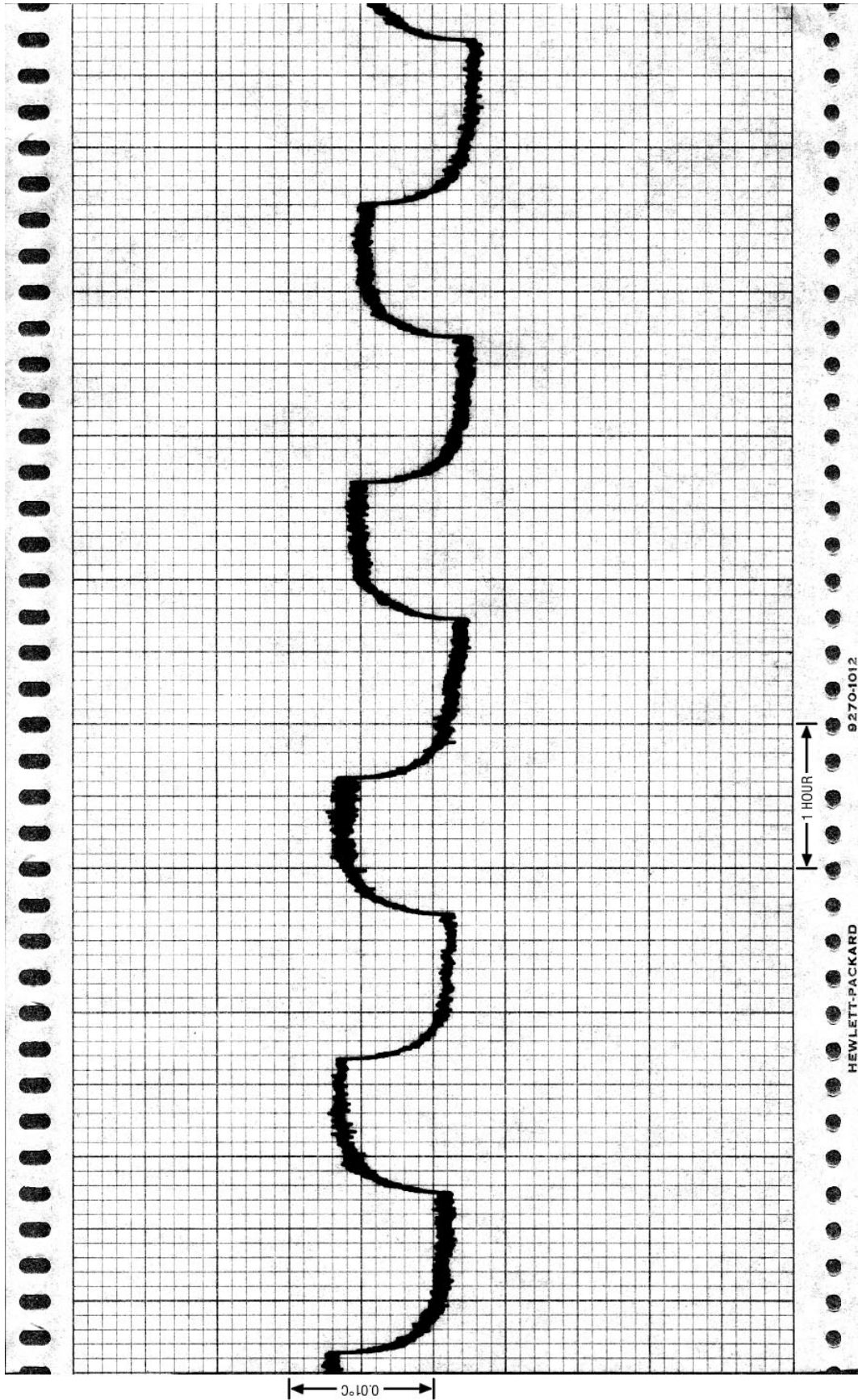

Figure 11. Long-Term Cooling Mode Stability Measured in Environment that Steps 20 Degrees Above Ambient Every Hour. Data Shows Resulting 0.008°C Peak-to-Peak Variation, Indicating Thermal Gain of 2500. 0.0025°C Baseline Tilt Over Plot Length Derives From Varying Ambient Temperature

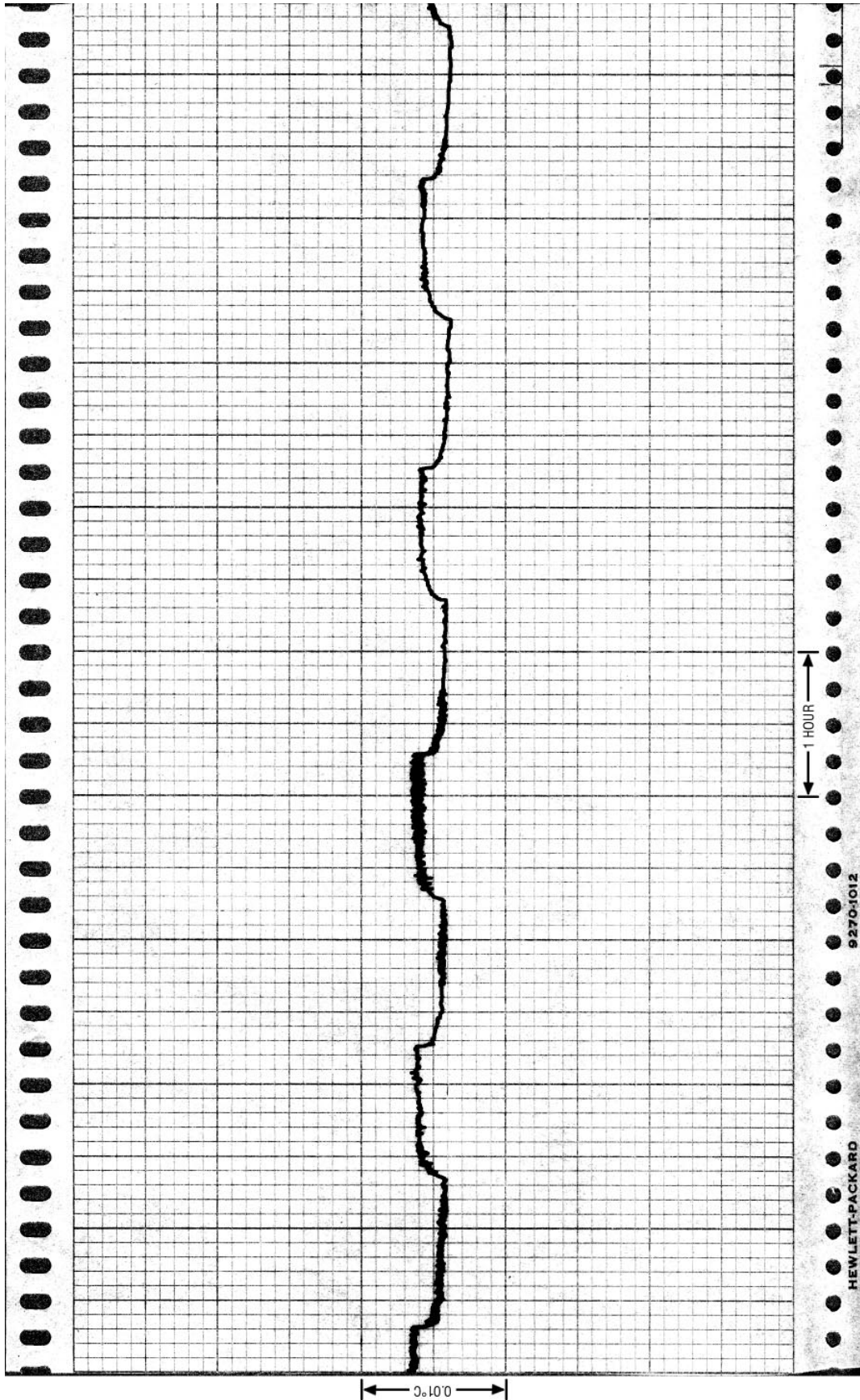

Figure 12. Identical Test Conditions as Figure 11, Except in Heating Mode. TEC's Higher Heating Mode Efficiency Results in Higher Thermal Gain. 0.002°C Peak-to-Peak Variation Is 4x Stability Improvement. Baseline Tilt, Just Detectable, Shows Similar 4x Improvement vs Figure 11

Application Note 89

Reflected Noise Performance

The switched mode power delivery to the TEC provides efficient operation but raises concerns about noise injected back into the host system via the power supply. In particular, the switching edge's high frequency harmonic content can corrupt the power supply, causing system level problems. Such "reflected" noise can be troublesome to deal with. The LTC1923 avoids these issues by controlling the slew of its switching edges, minimizing high frequency harmonic content.⁹ This slowing down of switching transients typically reduces efficiency by only 1% to 2%, a small penalty for the greatly improved noise performance. Figure 13 shows noise and ripple at the 5V supply with slew control in use. Low frequency ripple,

12mV in amplitude, is usually not a concern, as opposed to the high frequency transition related-components, which are much lower. Figure 14, a time and amplitude expansion of Figure 13, more clearly studies high frequency residue. High frequency amplitude, measured at center screen, is about 1mV. The slew limiting's effectiveness is measured in Figure 15 by disabling it. High frequency content jumps to nearly 10mV, almost 10x worse performance. Leave that slew limiting in there!

Most applications are well served by this level of noise reduction. Some special cases may require even lower reflected noise. Figure 16's simple LC filter may be employed in these cases. Combined with the LTC1923's slew limiting, it provides vanishingly small reflected ripple and

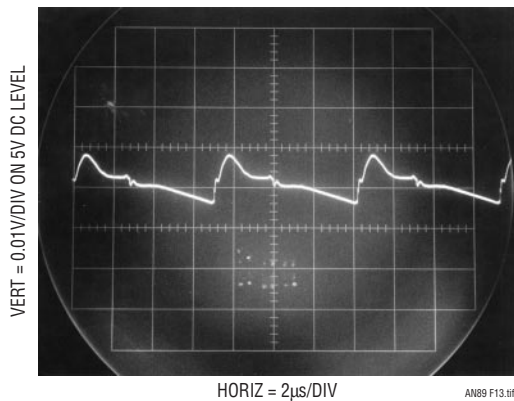

Figure 13. "Reflected" Noise at 5VDC Input Supply Due to Switching Regulator Operation with Edge Slew Rate Limiting in Use. Ripple Is 12mV_{P-P}, High Frequency Edge Related Harmonic Is Much Lower

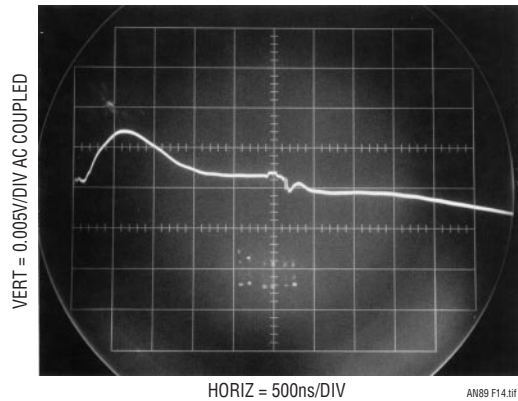

Figure 14. Time and Amplitude Expansion of Figure 13 More Clearly Shows Residual High Frequency Content with Slew Limiting Employed

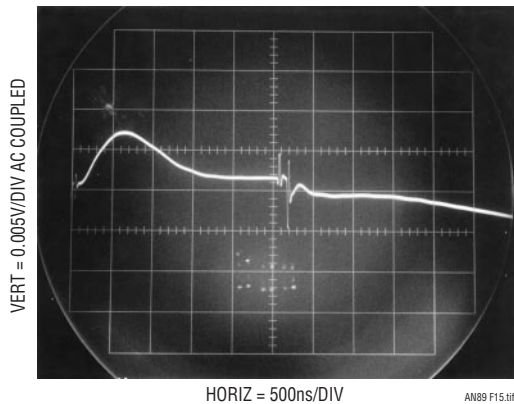

Figure 15. Same Test Conditions as Previous Figure, Except Slew Limiting Is Disabled. High Frequency Harmonic Content Rises \approx x10. Leave that Slew Limiting in There!

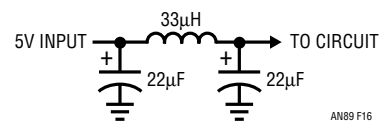

Figure 16. LC Filter Produces 1mV Reflected Ripple and 500µV High Frequency Harmonic Noise Residue

Note 9: This technique derives from previous work. See Reference 1.

high frequency harmonics. Figure 17, taken using this filter, shows only about 1mV of ripple, with submillivolt levels of high frequency content. Figure 18 expands the time scale to examine the high frequency remnants. Amplitude is 500 μ V, about 1/3 Figure 14's reading. As before,

slew limiting effectiveness is measurable by disabling it. This is done in Figure 19, with a resulting 4.4x increase in high frequency content to about 2.2mV. As in Figure 15, if lowest reflected noise is required, leave that slew limiting in there!

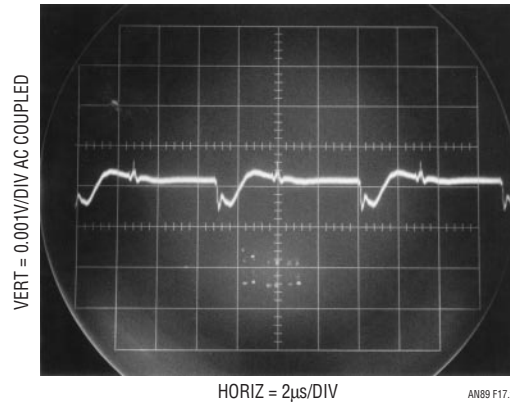

Figure 17. 5V Supply Reflected Ripple Measures 1mV with Figure 16's LC Filter in Use, a 10x Reduction Over Figure 13. Switching Edge Related Harmonic Content Is Small Due to Slew Limiting Action

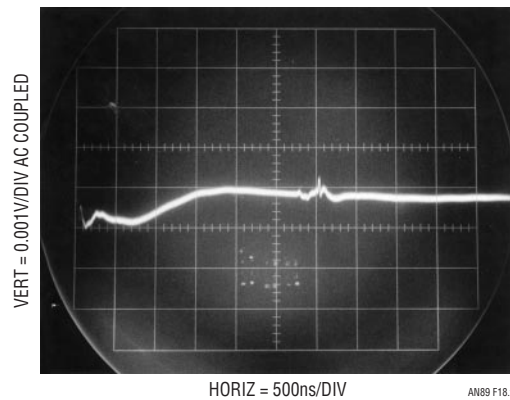

Figure 18. Horizontal Expansion Permits Study of High Frequency Harmonic with Slew Limiting Enabled. Amplitude Is 500 μ V, About 1/3 Figure 14's Reading

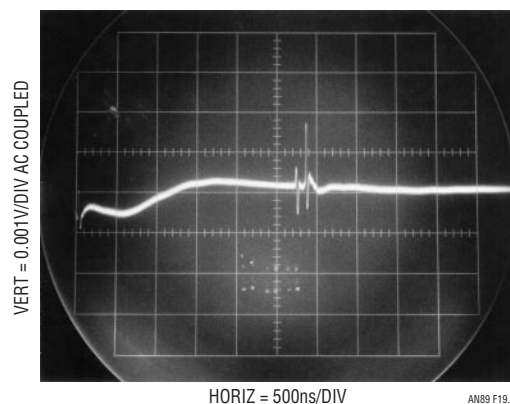

Figure 19. Same Conditions as Previous Figure, Except Slew Limiting Is Disabled. Harmonic Content Amplitude Rises to 2.2mV, a 4.4x Degradation. As in Figure 15, Leave that Slew Limiting in There!

Application Note 89

REFERENCES

1. Williams, J., "A Monolithic Switching Regulator with 100 μ V Output Noise," Linear Technology Corporation, Application Note 70, October 1997.
2. Williams, J., "Thermal Techniques in Measurement and Control Circuitry," Linear Technology Corporation, Application Note 5, December 1984.
3. Williams, J., "Temperature Controlling to Microdegrees," Massachusetts Institute of Technology Education Research Center, October 1971.
4. Fulton, S. P., "The Thermal Enzyme Probe," Thesis, Massachusetts Institute of Technology, 1975.
5. Olson, J. V., "A High Stability Temperature Controlled Oven," Thesis, Massachusetts Institute of Technology, 1974.
6. Harvey, M. E., "Precision Temperature Controlled Water Bath," *Review of Scientific Instruments*, p. 39-1, 1968
7. Williams, J., "Designer's Guide to Temperature Control," *EDN Magazine*, June 20, 1977.
8. Trolander, Harruff and Case, "Reproducibility, Stability and Linearization of Thermistor Resistance Thermometers," ISA, Fifth International Symposium on Temperature, Washington, D. C., 1971.

Note: This Application Note was derived from a manuscript originally prepared for publication in EDN magazine.

APPENDIX A

PRACTICAL CONSIDERATIONS IN THERMOELECTRIC COOLER BASED CONTROL LOOPS

There are a number of practical issues involved in implementing thermoelectric cooler (TEC) based control loops. They fall within three loosely defined categories. These include temperature setpoint, loop compensation and loop gain. Brief commentary on each category is provided below.

Temperature Setpoint

It is important to differentiate between temperature accuracy and stability requirements. The exact temperature setpoint is not really important, so long as it is stable. Each individual laser's output maximizes at some temperature (see text Figures 1 and 2). Temperature setpoint is typically incremented until this peak is achieved. After this, only temperature setpoint stability is required. This is why thermistor tolerances on laser module data sheets are relatively loose (5%). Long-term (years) temperature setpoint stability is primarily determined by thermistor stability over time. Thermistor time stability is a function of operating temperatures, temperature cycling, moisture contamination and packaging. The laser modules' relatively mild operating conditions are very benign, promoting good long-term stability. Typically, assuming good grade thermistors are used at module fabrication, thermistor stability comfortably inside 0.1°C over years may be expected.

Also related to temperature setpoint is that the servo loop controls *sensor* temperature. The laser operates at a somewhat different temperature, although laser temperature stability depends upon the stable loop controlled environment. The assumption is that laser dissipation constant remains fixed, which is largely true.¹

Loop Compensation

Figure 3's "dominant pole" compensation scheme takes advantage of the long time constant from ambient into the laser module (see text Figure 5). Loop gain is rolled off at a frequency low enough to accommodate the TEC-thermistor lag (see text Figure 6) but high enough to smooth transients arriving from the outside ambient. The relatively high TEC-thermistor to module insulation time constant ratio (<1 second to minutes) makes this approach viable. Attempts at improving loop response with more sophisticated compensation schemes encounter difficulty due to laser module thermal term uncertainties. Thermal terms can vary significantly between laser module brands,

Note 1: Academics will be quick to note that this phenomenon also occurs in the sensor's operation. Strictly speaking, the sensor operates at a slightly elevated temperature from its nominally isothermal environment. The assumption is that its dissipation constant remains fixed, which is essentially the case. Because of this, its temperature is stable.

rendering tailored compensation schemes impractical or even deleterious. Note that this restriction still applies, although less severely, even for modules of “identical” manufacture. It is very difficult to maintain tight thermal term tolerances in production.

The simple dominant pole compensation scheme provides good loop response over a wide range of laser module types. It’s the way to go.

Loop Gain

Loop gain is set by both electrical and thermal gain terms. The most unusual aspect of this is different TEC gain in heating and cooling modes. Significantly more gain is available in heating mode, accounting for the higher stabilities noted in the text (Figures 11 and 12). This higher gain means that loop gain bandwidth limits should be

determined in heating mode to avoid unpleasant surprises. Figure 3’s suggested loop gain and compensation values reflect this. It is certainly possible to get cute by changing loop gain bandwidth with mode but performance improvement is probably not worth the ruckus.²

It is important to remember that the TEC is a heat pump, the efficiency of which depends on the temperature across it. Gain varies with efficiency, degrading temperature stability as efficiency decreases. The laser module should be well coupled to some form of heat sink.³ The small amount of power involved does not require large sink capability but adequate thermal flow must be maintained. Usually, coupling the module to the circuit’s copper ground plane is sufficient, assuming the plane is not already thermally biased.

Note 2: The LTC1923’s “heat-cool” status pin beckons alluringly.

Note 3: Yes, this means you should use that messy white goop. A less obnoxious alternative is the thermally conductive gaskets, which are nearly as good.

Hey there,
Check me out.
I'll chill you out,
Stabilize your wavelength
& provide I, V & temperature
limiting. I've got edge slew
rate control for low noise,
switched mode, power delivery.
And, I'm fully synchronizable,
compact & have TEC
state monitoring outputs.
All on a single rail.

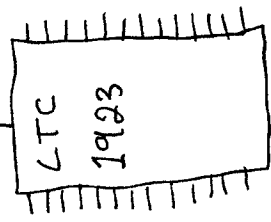

That kind of talk
makes me feel
so coherent.

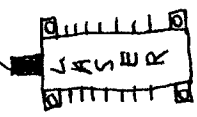

www.l