



SP6853

Green-Mode PWM Controller

DESCRIPTION

The SP6853 is a low cost , low startup current , current mode PWM controller with green-mode power-saving operation. The integrated functions include the leading-edge blanking of the current sensing, internal slope compensation. It would provide the users a superior AC/DC power application of higher efficiency, low external component counts, and lower cost solution for applications.

The SP6853 features more protections or functions for the following characteristics :

※Add OLP (Over Load Protection) function to provide better protection performance for fault conditions like short circuit or over load.

※Modify the OVP (Over Voltage Protection) mechanism from the cycle-by-cycle mode to the hiccup mode.

SP6853 is available by SOT-23-6L / DIP-8P packages.

FEATURES

- High-Voltage BiCMOS Process
- Very Low Startup Current (<math><20\mu\text{A}</math>)
- Under Voltage Lockout (UVLO)
- Current Mode Control
- Non-audible-noise Green Mode Control
- Current Limiting
- LEB (Leading-Edge Blanking) on CS Pin
- OLP (Over Load Protection)
- OVP (Over Voltage Protection) on Vcc Pin
- Leading-Edge Blanking
- Programmable Switching Frequency
- Internal Slope Compensation
- Green-Mode Control for Power Saving
- 300mA Driving Capability
-

APPLICATIONS

- AC/DC Switching Power Adaptor
- Battery Charger
- PC 5V Standby Power.
- Open-Frame Switching Power Supply

PIN CONFIGURATION

SOT-23-6L

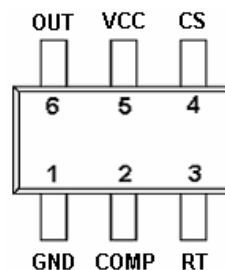

DIP-8P

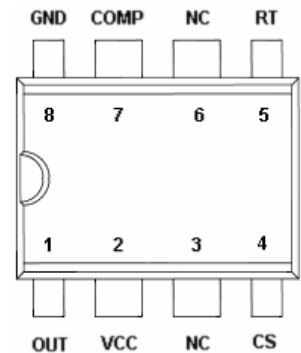

PART MARKING

SOT-23-6L

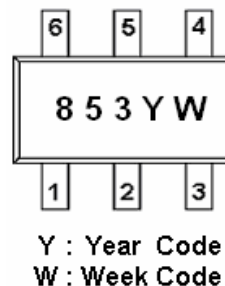

DIP-8P





SP6853 Green-Mode PWM Controller

TYPICAL APPLICATION CIRCUIT

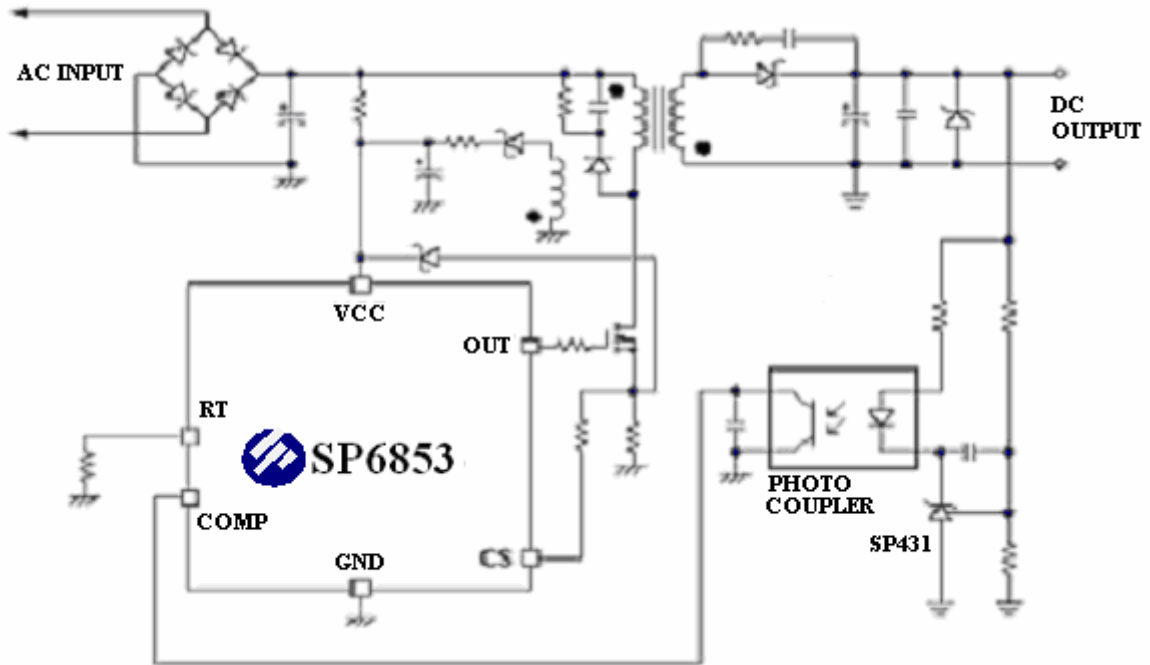

TYPICAL APPLICATION CIRCUIT (High Efficiency SMPS + Synchronous Rectifier)

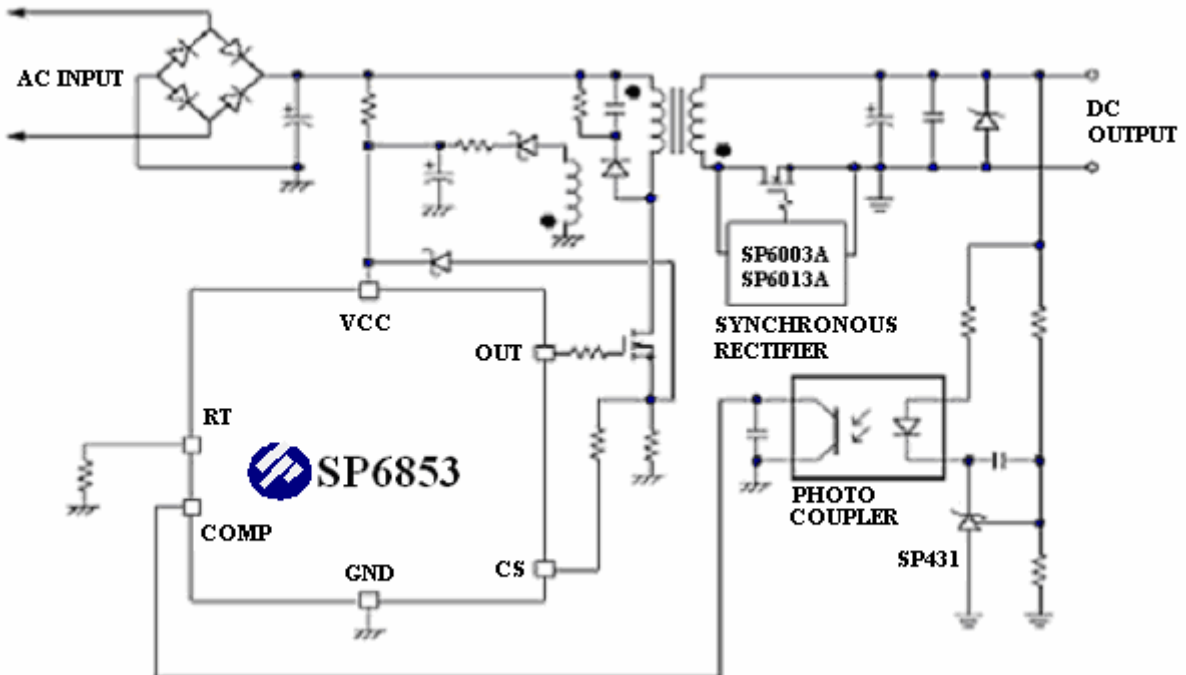



SP6853

Green-Mode PWM Controller

PIN DESCRIPTION

SP6853D8TG

Pin	Symbol	Description
1	OUT	Gate driver output to drive the external MOSFET
2	VCC	Supply Voltage in
3	NC	Unconnected pin
4	CS	Current sense. This pin senses the voltage across a resistor, to control PWM output. This pin also provides current amplitude information for current-mode control.
5	RT	This current is used to charge an internal capacitor, to determine the switching frequency.
6	NC	Unconnected pin
7	COMP	Voltage feedback. The pin provides the output voltage regulation signal., it provides feedback to the internal PWM comparator, so that the PWM comparator can control the duty cycle.
8	GND	Ground

SP6853S26RG

Pin	Symbol	Description
1	GND	Ground
2	COMP	Voltage feedback. The pin provides the output voltage regulation signal., it provides feedback to the internal PWM comparator, so that the PWM comparator can control the duty cycle
3	RT	This current is used to charge an internal capacitor, to determine the switching frequency.
4	CS	Current sense. This pin senses the voltage across a resistor, to control PWM output. This pin also provides current amplitude information for current-mode control
5	VCC	Supply Voltage in
6	OUT	Gate driver output to drive the external MOSFET

BLOCK DIAGRAM

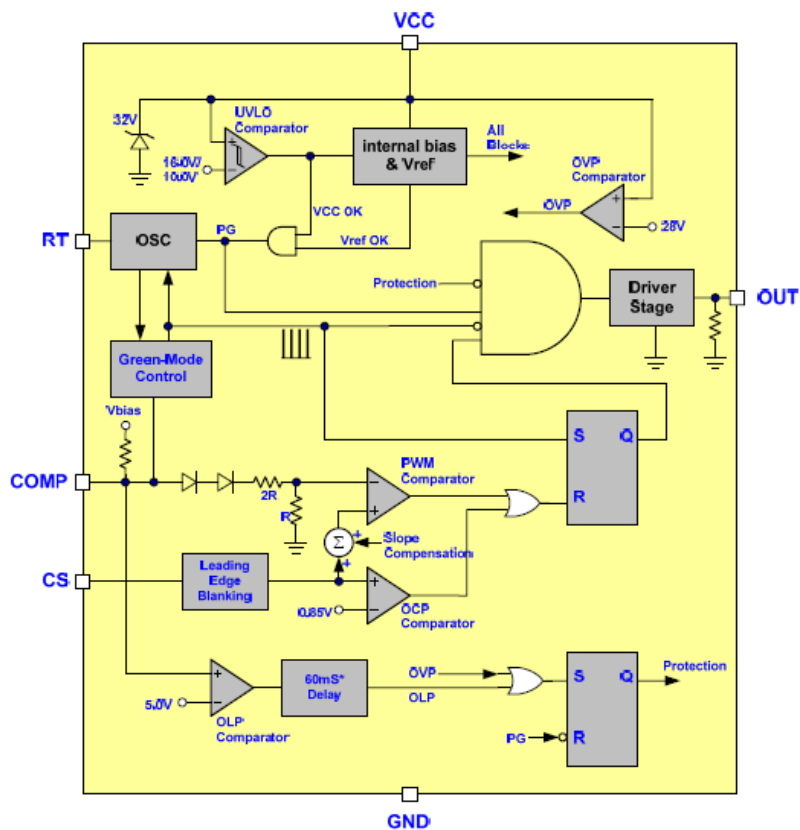



SP6853

Green-Mode PWM Controller

ORDERING INFORMATION

Part Number	Package	Part Marking
SP6853D8TGB	DIP-8P	SP6853I
SP6853S26RGB	SOT-23-6L	853YW

※ SP6853D8TG : Tube ; Pb – Free ; Halogen-Free

※ SP6853S26RG : Tape Reel ; Pb – Free ; Halogen-Free

ABSOLUTE MAXIMUM RATINGS (T_A=25°C, unless otherwise specified.)

The following ratings designate persistent limits beyond which damage to the device may occur.

Symbol	Parameter	Value	Unit
V _{CC}	DC Supply Voltage	36	V
V _{COMP/RT/CS}	COMP / RT / CS Voltage	-0.3 ~ 7.0	V
P _D	Power Dissipation @ T _A =85°C (*)	0.3	W
ESD	Human Body Model	4	KV
	Machine Model	300	V
T _{ope}	Operating Ambient Temperature	-40 ~ 85	°C
T _J	Operating Junction Temperature Range	-40 ~ 150	°C
T _{STG}	Storage Temperature Range	-40 ~ 150	°C
T _{LEAD}	Pb-Free Lead Soldering Temperature for 5 sec.	260	°C
R _{θJC}	Thermal Resistance Junction – Case (*)	SOT-23-6L	210
		DIP-8P	95

(*) The power dissipation and thermal resistance are evaluated under copper board mounted with free air conditions.



SP6853

Green-Mode PWM Controller

ELECTRICAL CHARACTERISTICS

($T_A=25^{\circ}\text{C}$, $V_{CC}=15\text{V}$, unless otherwise specified.)

Symbol	Parameter	Conditions	Min.	Typ.	Max.	Unit
Supply Voltage (Vcc Pin)						
I _{stt}	Startup Current			10	20	uA
I _{op}	Operating Current	V _{COMP} = 0V		2.7	4	mA
		V _{COMP} = 3V		2.4		mA
		Protection tripped (OLP, OVP)		1.0		mA
UVLO (off)	Min. Operating Voltage		9.0	10.0	11.0	V
UVLO (on)	Start Threshold Voltage		15.0	16.0	17.0	V
OVP Level	Over Voltage Protection		24	26	29.5	V
Voltage Feedback (Comp Pin)						
I _{sc}	Short Circuit Current			1.25	2.2	mA
V _{op}	Open Loop Voltage			6		V
V _{TH(GM)}	Green Mode Threshold V _{COMP}			2.35		V
Oscillator (RT Pin)						
F _{osc}	Frequency	R _T =100K Ω	60.0	68.0	75.0	KHz
F _{osc(GM)}	Green Mode Frequency	F _s =65.0KHz		22		KHz
F _{dt}	Frequency Variation versus Temp. Deviation	(-40 $^{\circ}\text{C}$ ~105 $^{\circ}\text{C}$)			3	%
F _{dv}	Frequency Variation versus V _{CC} Deviation	(V _{CC} =11V-25V)			1	%
Current Sensing (CS Pin)						
V _{cs(off)}	Maximum Input Voltage		0.8	0.85	0.9	V
T _{LEDD}	Leading Edge Blanking Time			280		nS
Z _{cs}	Input impedance		1			M Ω
T _{PD}	Delay to Output			100		nS
Gate Driver Output (OUT Pin)						
DC (Max)	Maximum Duty Cycle		70	75	80	%
DC (Min)	Minimum Duty Cycle			0		%
V _{OL}	Output Low Level	V _{CC} =15V, I _o =20mA			1	V
V _{OH}	Output High Level	V _{CC} =15V, I _o =20mA	8			V
T _r	Rising Time	Load Cap=1000pF		50	200	nS
T _f	Falling Time	Load Cap=1000pF		30	120	nS
OLP (Over Load Protection)						
T _{LOLP}	OLP Trip Level			5.0		V
T _{DOLP}	OLP Delay Time (note)			60		mS

Note: The OLP delay time is proportional to the period of switching cycle. So that, the lower RT value will set the higher switching frequency and the shorter OLP delay time.



SP6853 Green-Mode PWM Controller

PERFORMANCE CHARACTERISTICS ($T_A=25^{\circ}\text{C}$, unless otherwise specified.)

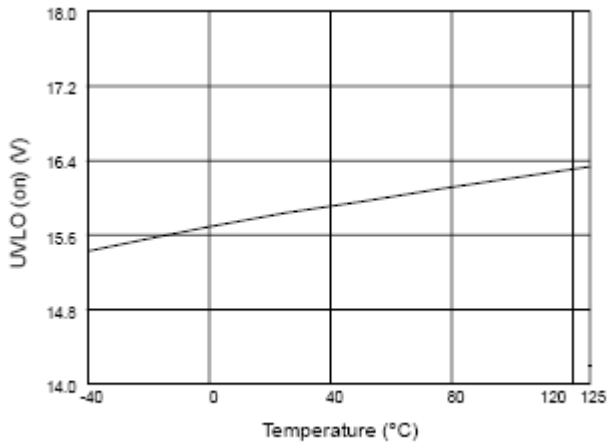

Fig. 1 UVLO (on) vs. Temperature

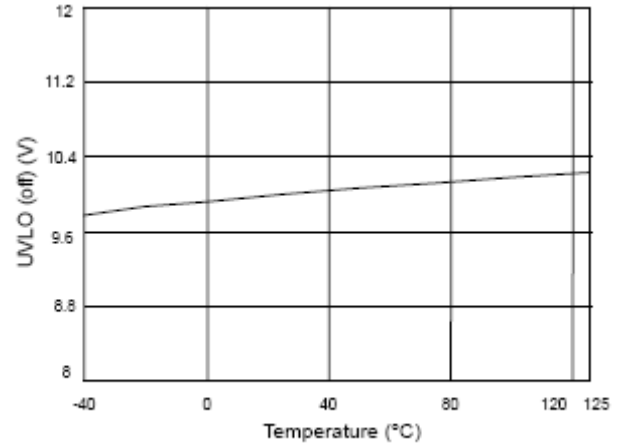

Fig. 2 UVLO (off) vs. Temperature

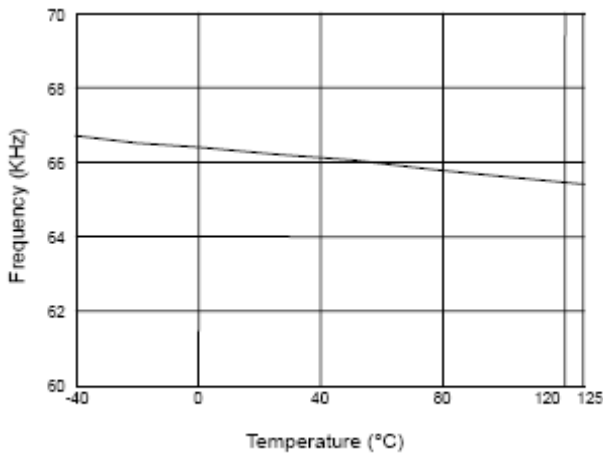

Fig. 3 Frequency vs. Temperature

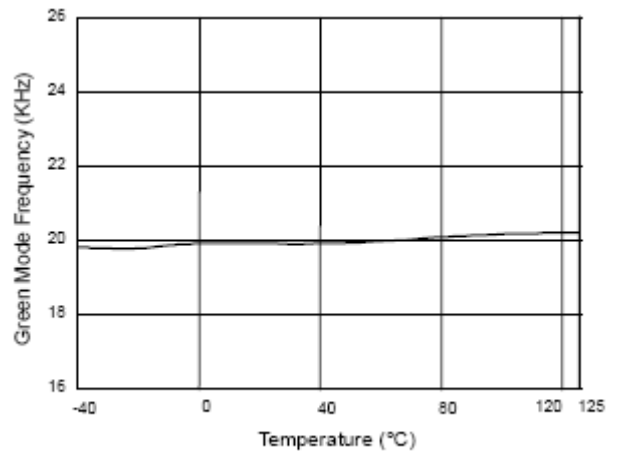

Fig. 4 Green Mode Frequency vs. Temperature

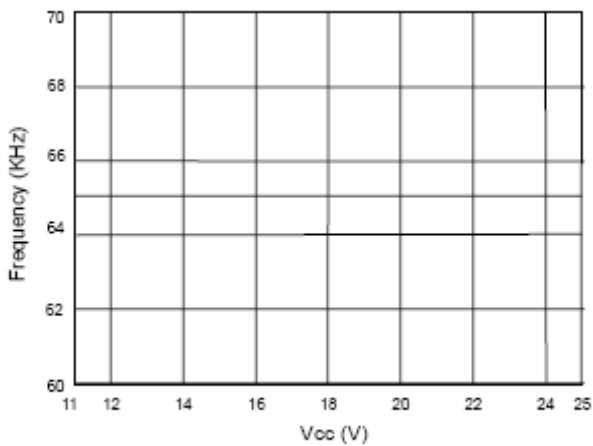

Fig. 5 Frequency vs. Vcc

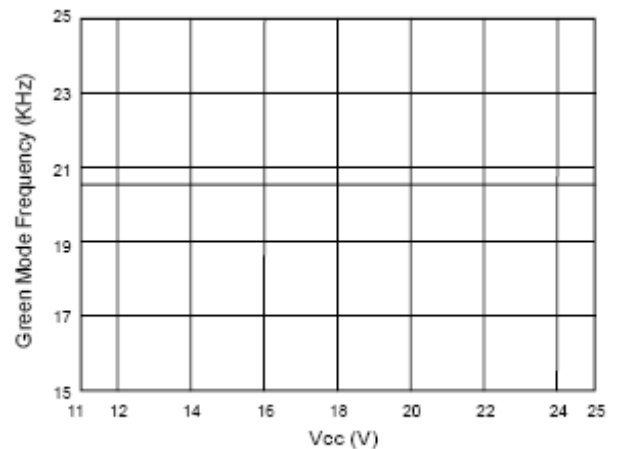

Fig. 6 Green Mode Frequency vs. Vcc



SP6853

Green-Mode PWM Controller

PERFORMANCE CHARACTERISTICS ($T_A=25^\circ\text{C}$, unless otherwise specified.)

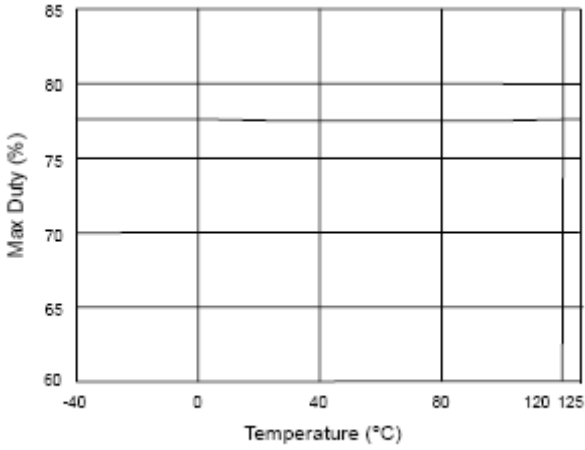

Fig. 7 Max Duty vs. Temperature

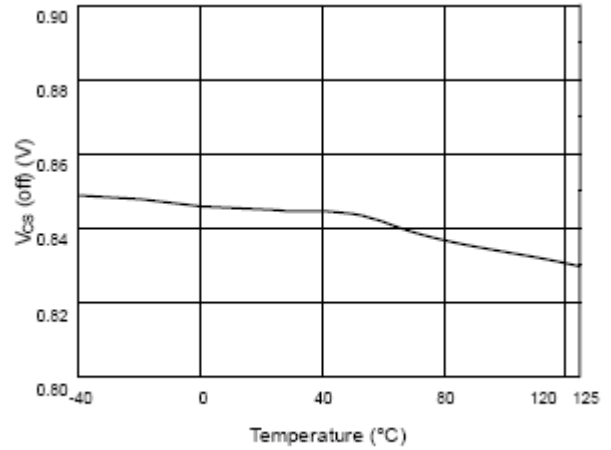

Fig. 8 $V_{CS(off)}$ vs. Temperature

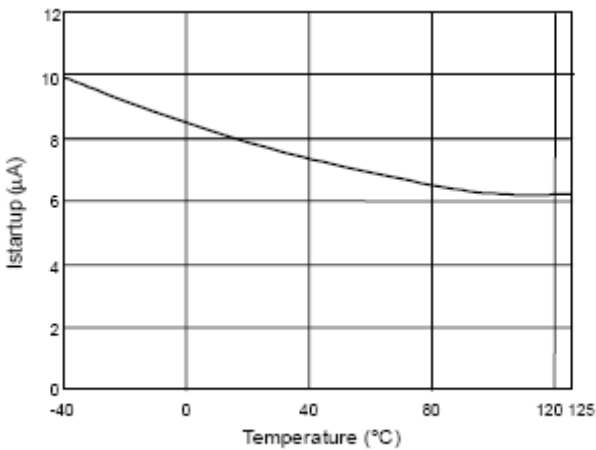

Fig. 9 Startup Current ($I_{startup}$) vs. Temperature

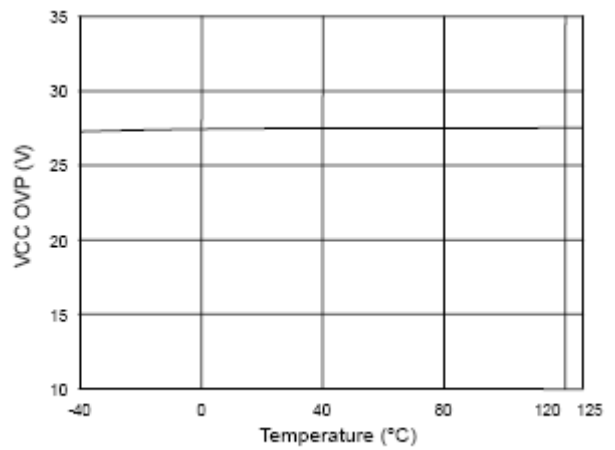

Fig. 10 VCC OVP vs. Temperature

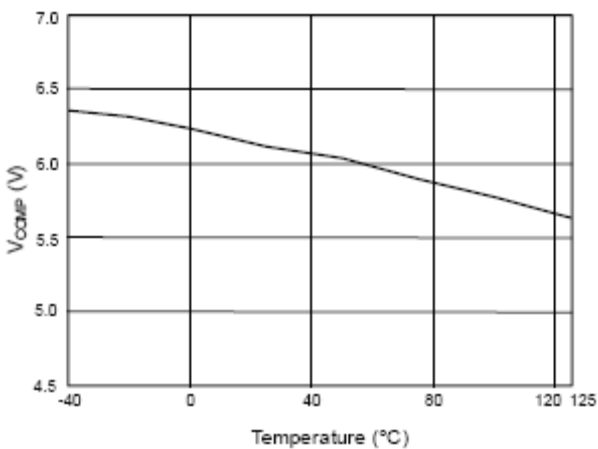

Fig. 11 V_{comp} open loop voltage vs. Temperature

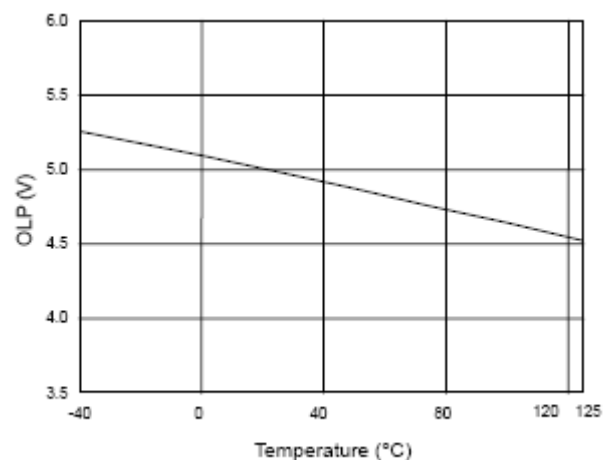
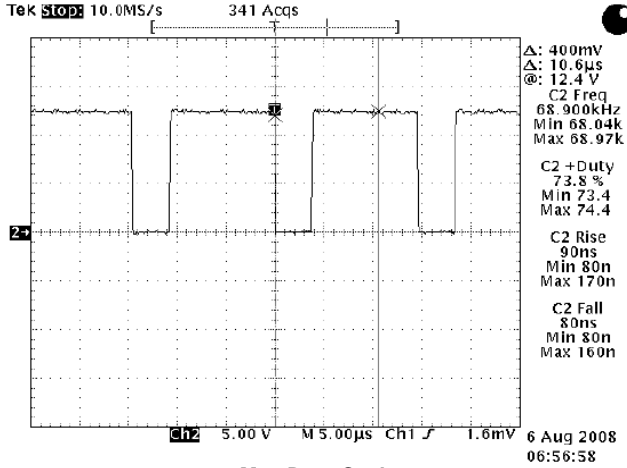

Fig. 12 OLP-Trip Level vs. Temperature



SP6853 Green-Mode PWM Controller

PERFORMANCE CHARACTERISTICS ($T_A=25^{\circ}\text{C}$, unless otherwise specified.)



Max Duty Cycle

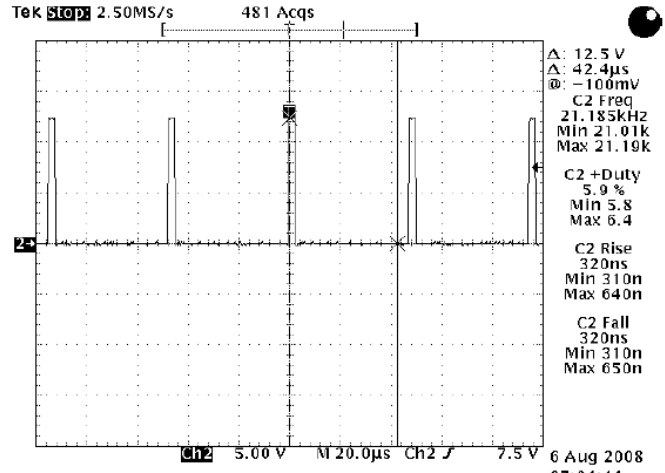

Min Duty Cycle

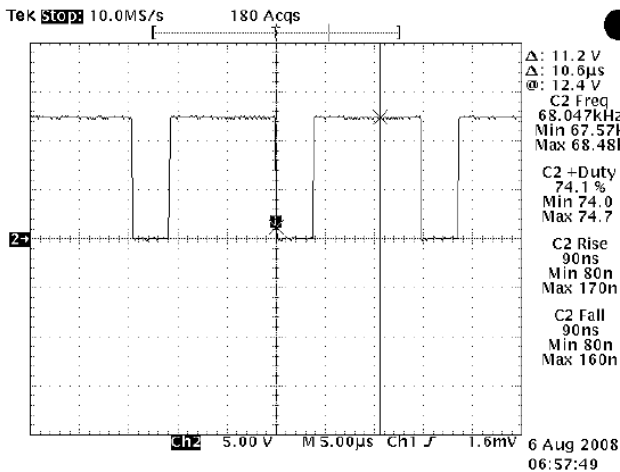

Max Duty Cycle

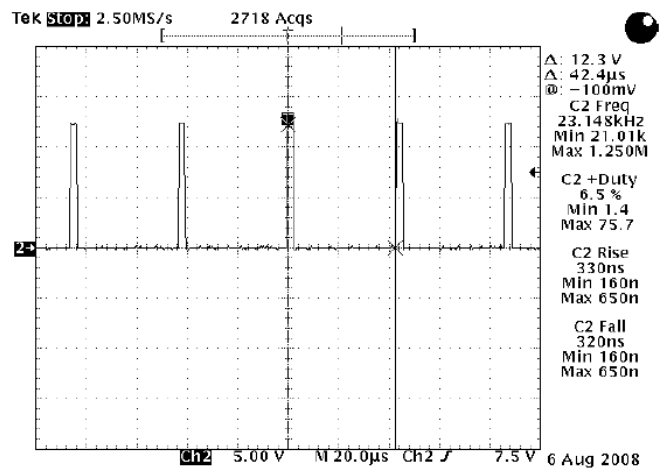

Min Duty Cycle

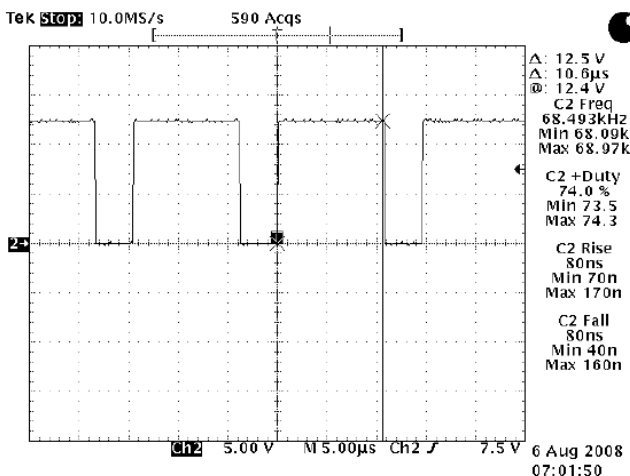

Max Duty Cycle

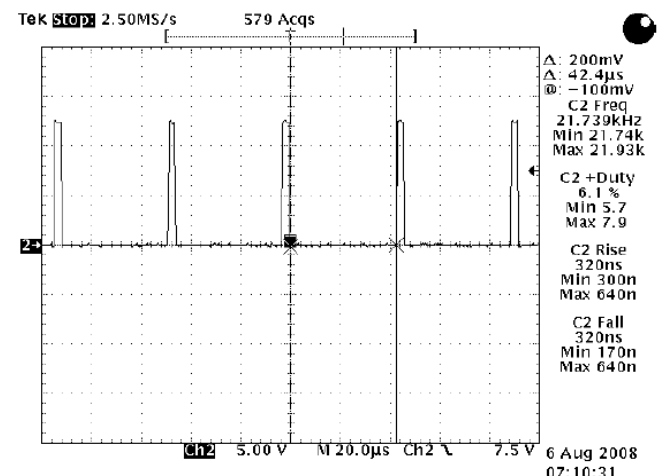

Min Duty Cycle



SP6853 Green-Mode PWM Controller

PERFORMANCE CHARACTERISTICS ($T_A=25^{\circ}\text{C}$, unless otherwise specified.)

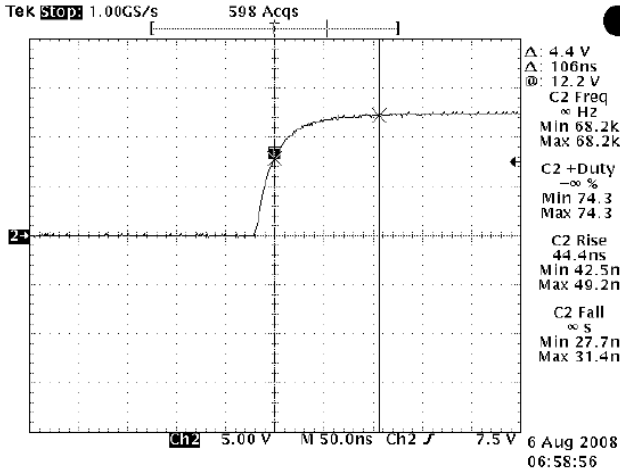

Rising Time Load

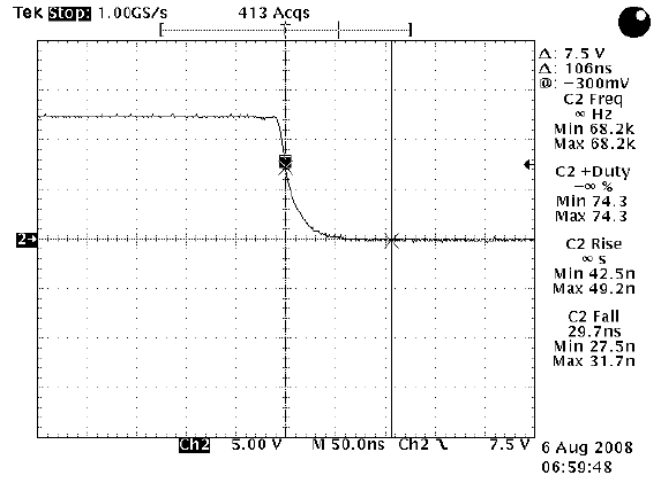

Falling Time Load

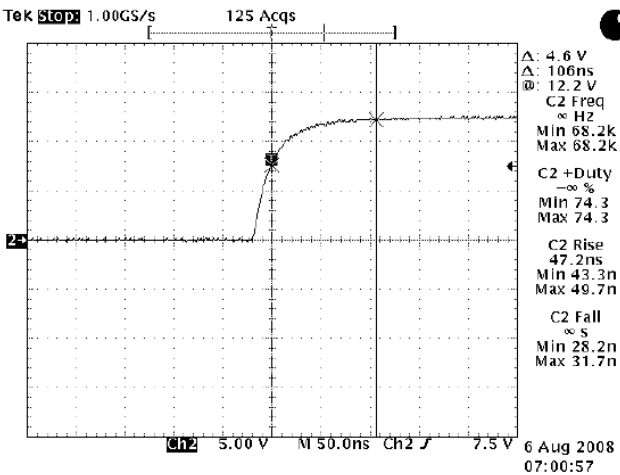

Rising Time Load

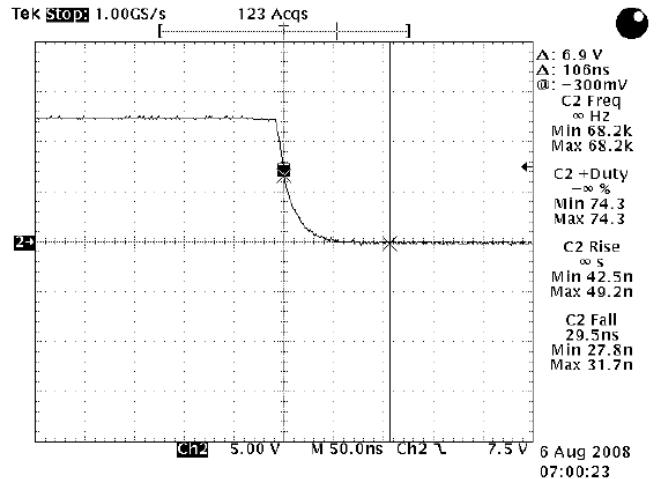

Falling Time Load

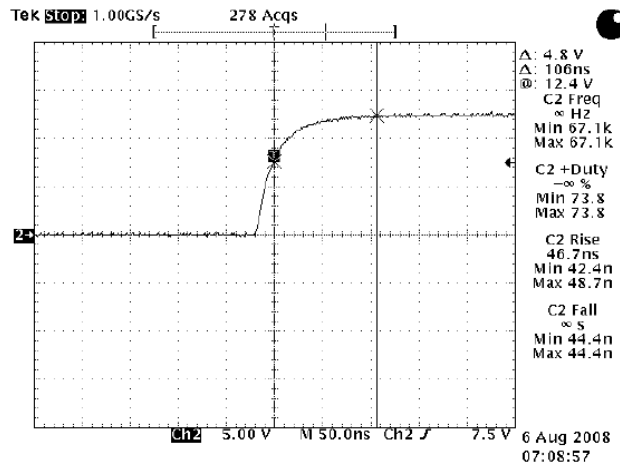

Rising Time Load

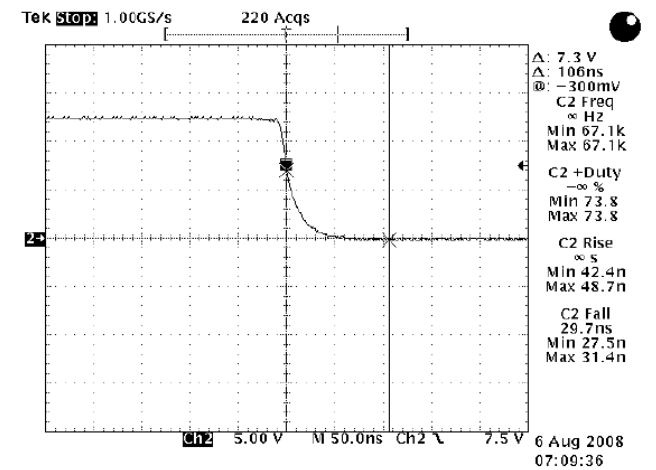

Falling Time Load



SP6853 Green-Mode PWM Controller

PERFORMANCE CHARACTERISTICS ($T_A=25^{\circ}\text{C}$, unless otherwise specified.)

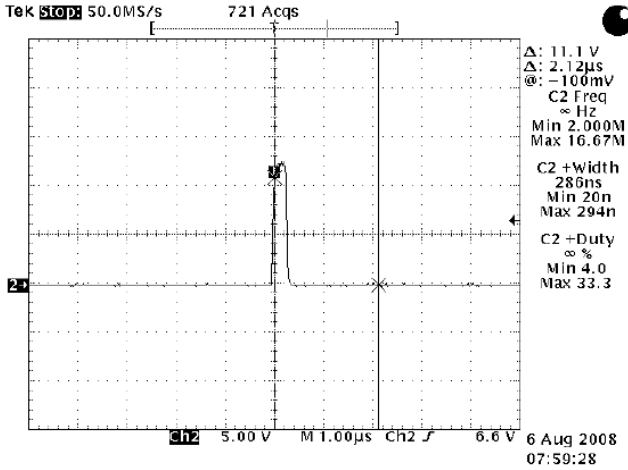

Leading Edge Blanking Time

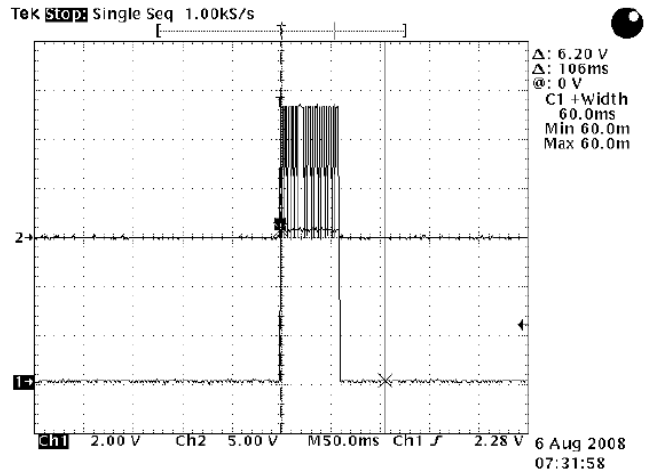

OLP Delay Time

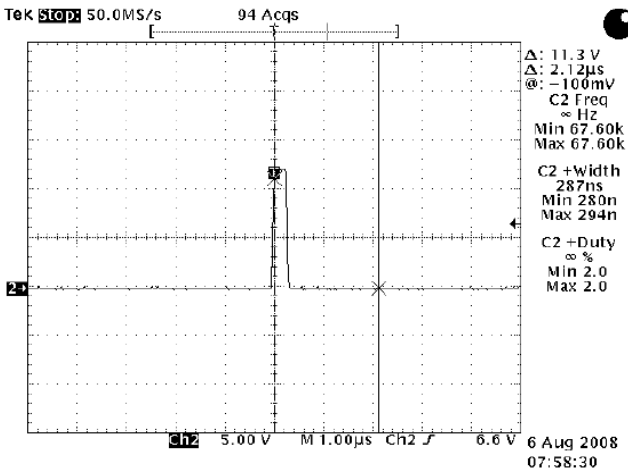

Leading Edge Blanking Time

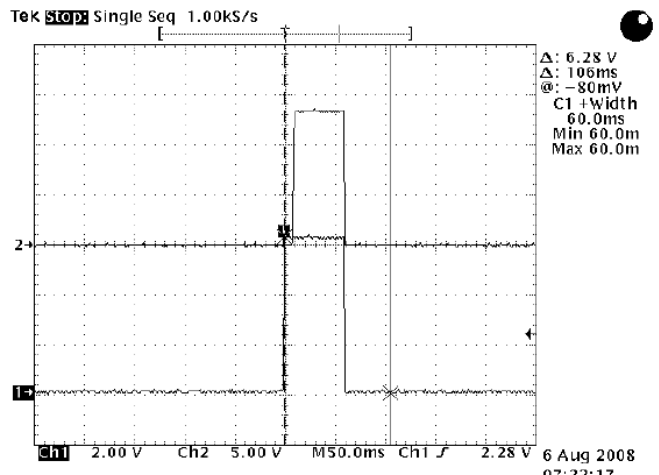

OLP Delay Time

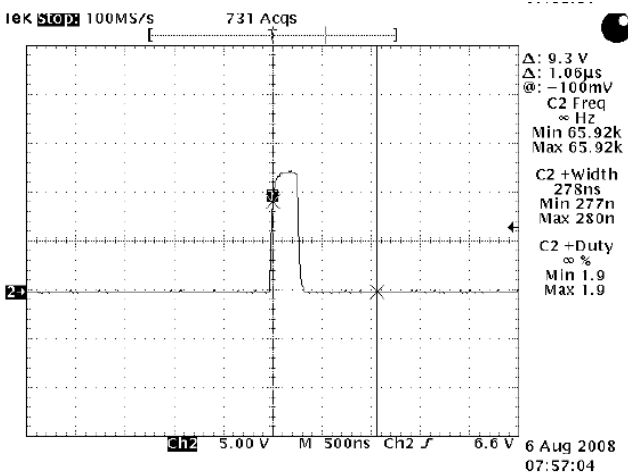

Leading Edge Blanking Time

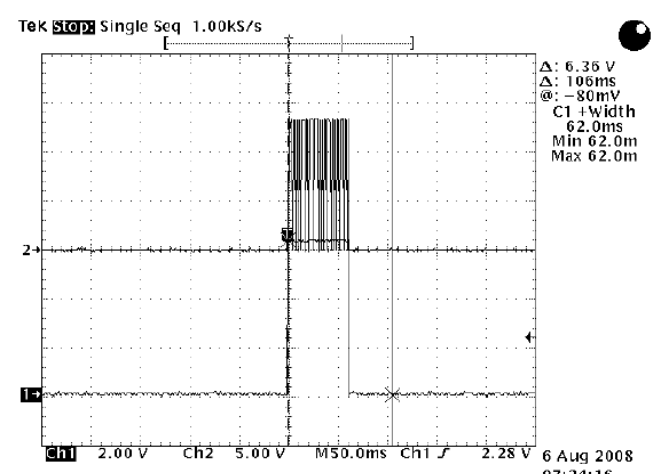

OLP Delay Time



SP6853

Green-Mode PWM Controller

DIP- 8P PACKAGE OUTLINE

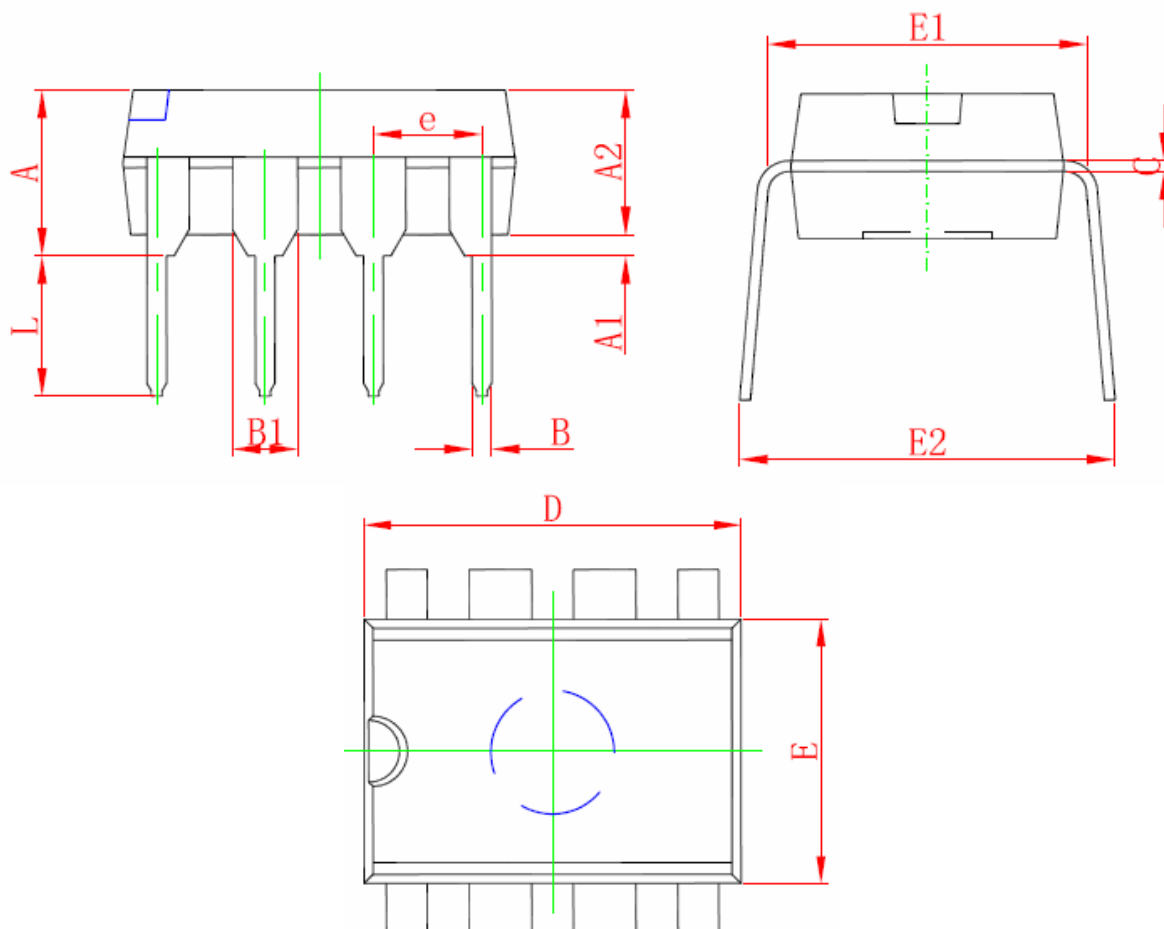

Symbol	Dimensions In Millimeters		Dimensions In Inches	
	Min	Max	Min	Max
A	3.710	4.310	0.146	0.170
A1	0.510		0.020	
A2	3.200	3.600	0.126	0.142
B	0.380	0.570	0.015	0.022
B1	1.524 (BSC)		0.060 (BSC)	
C	0.204	0.360	0.008	0.014
D	9.000	9.400	0.354	0.370
E	6.200	6.600	0.244	0.260
E1	7.320	7.920	0.288	0.312
e	2.540 (BSC)		0.100 (BSC)	
L	3.000	3.600	0.118	0.142
E2	8.400	9.000	0.331	0.354



SP6853

Green-Mode PWM Controller

SOT-23-6L PACKAGE OUTLINE

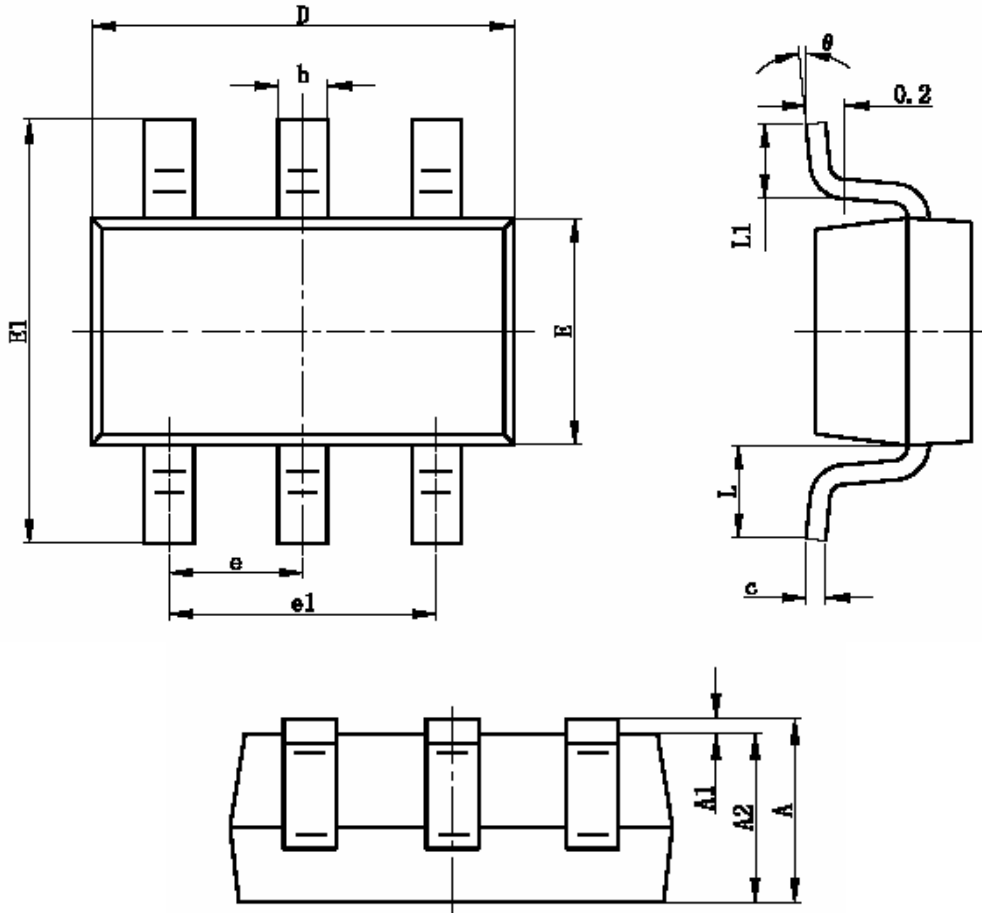

Symbol	Dimensions In Millimeters		Dimensions In Inches	
	Min	Max	Min	Max
A	1.050	1.250	0.041	0.049
A1	0.000	0.100	0.000	0.004
A2	1.050	1.150	0.041	0.045
b	0.300	0.400	0.012	0.016
c	0.100	0.200	0.004	0.008
D	2.820	3.020	0.111	0.119
E	1.500	1.700	0.059	0.067
E1	2.650	2.950	0.104	0.116
e	0.950TYP		0.037TYP	
e1	1.800	2.000	0.071	0.079
L	0.700REF		0.028REF	
L1	0.300	0.600	0.012	0.024
θ	0°	8°	0°	8°