

# High Efficiency, Low Cost LED Lighting Application

## 1. Demo Board Photo

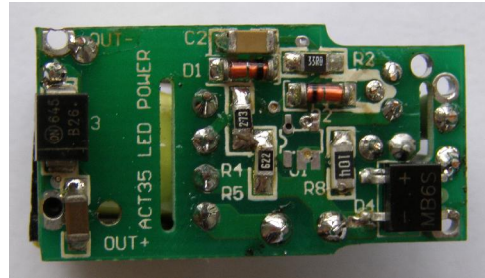

## 2. Schematics

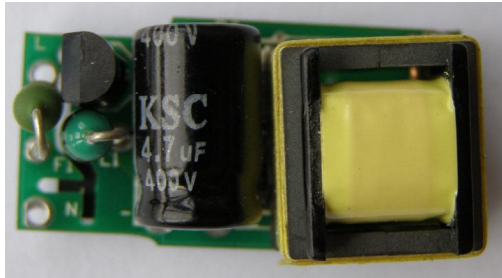
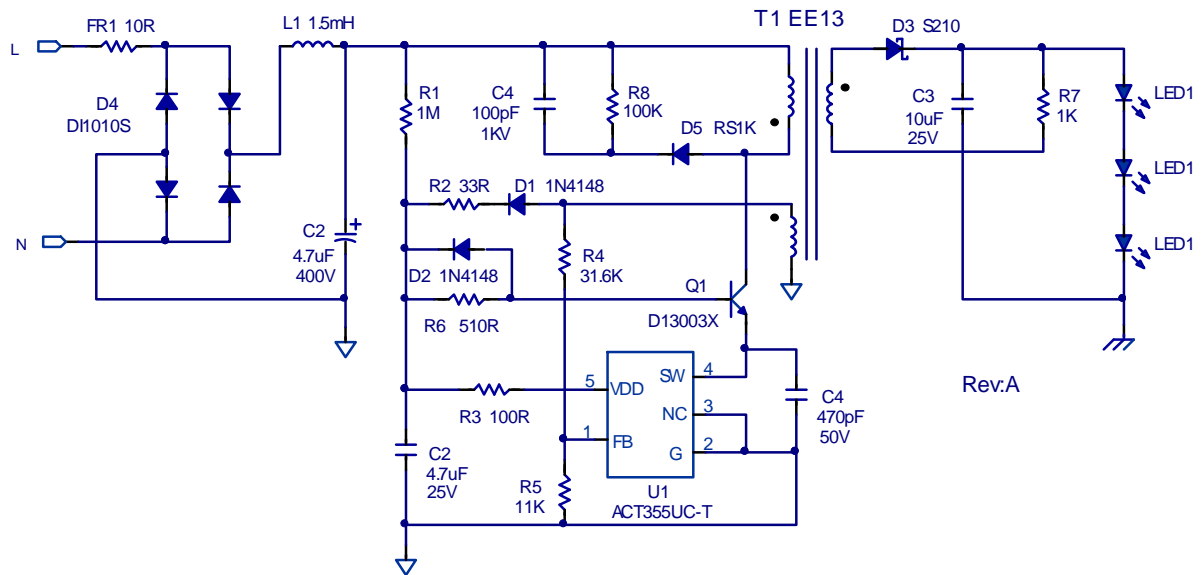

## 3. PCB Layout

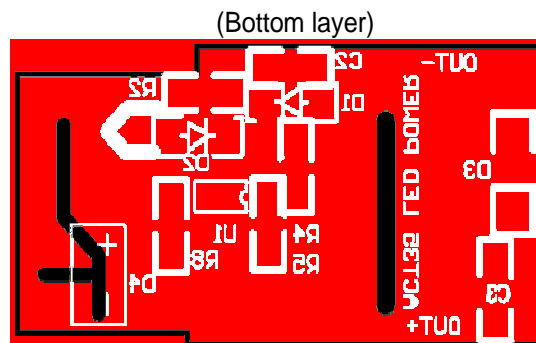
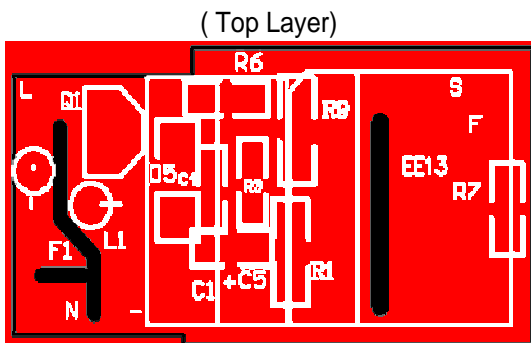

## 4. Bill OF Materials

Item	Ref.	Description	QTY	Manuf.
1	C1	Capacitor, Electrolytic, 4.7uF/400V, 8x12mm	1	KSC
2	C2	Capacitor, Ceramic,4.7uF/25V, 1206, SMD	1	POE
3	C3	Capacitor, Ceramic,10uF/25V,1210, SMD	1	TDK
4	C4	Capacitor, Ceramic, 470pF/50V,0805, SMD	1	POE
5	C5	Capacitor, Ceramic,100pF/1KV,0805, SMD	1	POE
6	D1,2	Diode,Switching,75V/150mA 1N4148 Milimelf	1	Good-Ark
7	D3	Diode, schottky, 100V/2A, S210, SMB	1	PANJIT
8	D4	Bridge Rectifier,1000V/1A, DI1010S, SDIP	1	PANJIT
9	D5	Diode,Ultra Fast, RS1K,800V/1A, SMA	1	PAN JIT
10	FR1	Fusible Resistor, 1W, 10 ohm, 5%, DIP	1	TY-OHM
11	L1	Axial Inductor, 1.5mH, 0410,DIP	1	
12	PCB	PCB,L*W*T=30x15.5x1.6mm, FR-4 Rev:A	1	Jing tong
13	Q1	Transistor, HFE 20-25, NPN, D13003X, TO-220	1	Hua Wei
14	R1	Meter Film Resistor, 1M ohm, 1206, 5%	1	TY-OHM
15	R2	Meter Film Resistor, 33 ohm, 0805, 5%	1	TY-OHM
16	R3	Meter Film Resistor, 100 ohm, 0805, 5%	1	TY-OHM
17	R4	Meter Film Resistor, 31.6K ohm, 0805, 1%	1	TY-OHM
18	R5	Meter Film Resistor, 11K ohm, 0805, 1%	1	TY-OHM
19	R6	Meter Film Resistor, 510 ohm, 0805, 5%	1	TY-OHM
20	R7	Meter Film Resistor, 1K ohm, 0805, 5%	1	TY-OHM
21	R8	Meter Film Resistor, 100K ohm, 1206, 5%	1	TY-OHM
22	T1	Transformer, Lp=1.7mH, EE-13	1	
20	U1	IC, ACT355AUC-T, SOT23-5	1	Active

## 5. Transformer Specification

### 5.1 Schematics

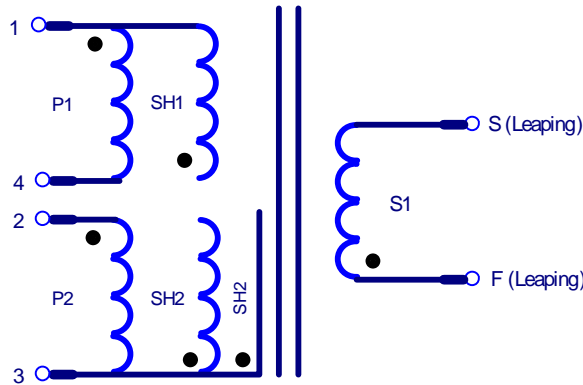

### Build-up Table

Winding	Terminal		Turns	Wire			Insulation	
	Start	Finish		Type	Size*QTY	Layer	Thick/Wide	Layer
SH1	open	1	10	2UEW	0.15Φ*4	1	25u/8.5mm	2
P1	1	4	120	2UEW	0.12Φ*1	3	25u/8.5mm	2
SH2	3	open	10	2UEW	0.15Φ*4	1	25u/8.5mm	2
S1	F(Leaping)	S(Leaping)	24	2UEW	0.45Φ*1	1	25u/8.5mm	2
P2	2	3	26	2UEW	0.15Φ*1	1	25u/8.5mm	3
SH3	3	open	10	2UEW	0.15Φ*4	1	25u/8.5mm	2

Note: P1 & P2 are primary and S1 is secondary ( Bobbin: EE-13 Horizontal )

### 5.2 Build-up Diagram

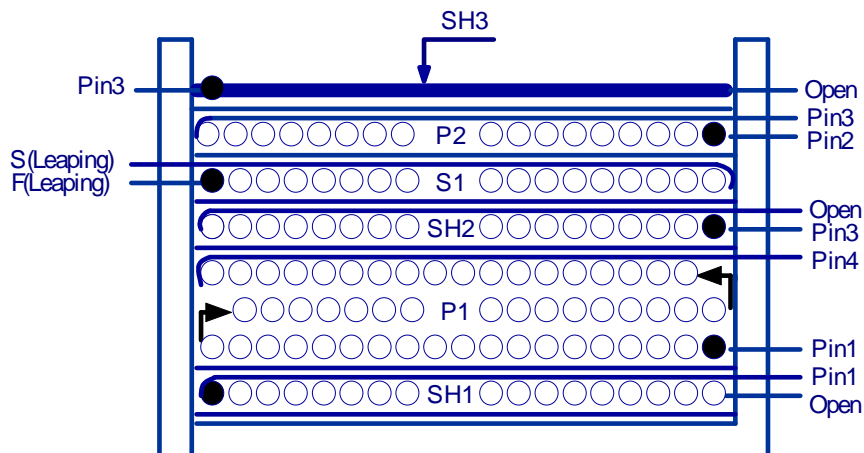

### 5.3 Electrical Specifications

Item	Description	Condition	Limits
1	Electrical Strength	50Hz, 1 minute, from primary and secondary	3000 Vac
2	P1 Inductance	Inductance between pins 1 and 2 at 1Vac & 1kHz	1.7mH ± 7%
3	P1Leakage Inductance	Inductance between pins 1 and 2 with pins 3-4 and 7-8 shorted	75μH

## 6. ACT355 Test Data

### 1.1 Efficiency

VIN (V <sub>AC</sub> )	2LED	3LED	4LED	PCS
110	73.39	74.28	72.98	%
220	73.63	73.74	74.29	%

### 1.2 Current Limit and Constant Current

Condition	2LED	3LED	4LED
85	345	342	334
110	352	346	338
220	358	349	343
264	353	347	334

### 1.3 Short Circuit Protection and Release

Protection	85 V <sub>AC</sub>	110 V <sub>AC</sub>	220V <sub>AC</sub>	264 V <sub>AC</sub>
■ Pin (W)	0.01	0.14	0.26	0.30