

GigaMOS™
Power MOSFET
IXFK260N17T
IXFX260N17T

 N-Channel Enhancement Mode
 Avalanche Rated
 Fast Intrinsic Diode



$$V_{DSS} = 170V$$

$$I_{D25} = 260A$$

$$R_{DS(on)} \leq 6.5m\Omega$$

$$t_{rr} \leq 200ns$$

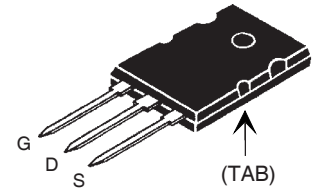
TO-264 (IXFK)

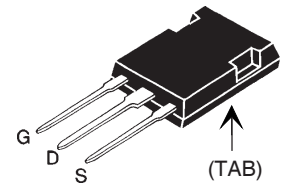

PLUS247 (IXFX)

 G = Gate D = Drain
 S = Source TAB = Drain

Symbol	Test Conditions	Maximum Ratings	
V_{DSS}	$T_J = 25^\circ C$ to $175^\circ C$	170	V
V_{DGR}	$T_J = 25^\circ C$ to $175^\circ C$, $R_{GS} = 1M\Omega$	170	V
V_{GSS}	Continuous	± 20	V
V_{GSM}	Transient	± 30	V
I_{D25}	$T_C = 25^\circ C$	260	A
$I_{L(RMS)}$	External Lead Current Limit	160	A
I_{DM}	$T_C = 25^\circ C$, Pulse Width Limited by T_{JM}	700	A
I_A	$T_C = 25^\circ C$	100	A
E_{AS}	$T_C = 25^\circ C$	3	J
P_D	$T_C = 25^\circ C$	1670	W
dV/dt	$I_S \leq I_{DM}$, $V_{DD} \leq V_{DSS}$, $T_J \leq 175^\circ C$	20	V/ns
T_J		-55 ... +175	$^\circ C$
T_{JM}		175	$^\circ C$
T_{stg}		-55 ... +175	$^\circ C$
T_L	1.6mm (0.062 in.) from Case for 10s	300	$^\circ C$
T_{SOLD}	Plastic Body for 10s	260	$^\circ C$
M_d	Mounting Torque (TO-264)	1.13/10	Nm/lb.in.
F_C	Mounting Force (PLUS247)	20..120 / 4.5..27	N/lb.
Weight	TO-264	10	g
	PLUS247	6	g

Symbol	Test Conditions ($T_J = 25^\circ C$ Unless Otherwise Specified)	Characteristic Values		
		Min.	Typ.	Max.
BV_{DSS}	$V_{GS} = 0V$, $I_D = 3mA$	200		V
$V_{GS(th)}$	$V_{DS} = V_{GS}$, $I_D = 8mA$	2.5		5.0 V
I_{GSS}	$V_{GS} = \pm 20V$, $V_{DS} = 0V$			± 200 nA
I_{DSS}	$V_{DS} = V_{DSS}$, $V_{GS} = 0V$ $T_J = 150^\circ C$			50 μA 5 mA
$R_{DS(on)}$	$V_{GS} = 10V$, $I_D = 60A$, Note 1			6.5 m Ω

Features

- International Standard Packages
- High Current Handling Capability
- Fast Intrinsic Diode
- Avalanche Rated
- Low $R_{DS(on)}$

Advantages

- Easy to Mount
- Space Savings
- High Power Density

Applications

- Synchronous Rectification
- DC-DC Converters
- Battery Chargers
- Switched-Mode and Resonant-Mode Power Supplies
- DC Choppers
- AC Motor Drives
- Uninterruptible Power Supplies
- High Speed Power Switching Applications

Symbol	Test Conditions	Characteristic Values		
		Min.	Typ.	Max.
g_{fs}	$V_{DS} = 10V, I_D = 60A, \text{Note 1}$	105	170	S
C_{iss}	$V_{GS} = 0V, V_{DS} = 25V, f = 1MHz$		24	nF
C_{oss}			2870	pF
C_{rss}			450	pF
$t_{d(on)}$	Resistive Switching Times $V_{GS} = 10V, V_{DS} = 0.5 \cdot V_{DSS}, I_D = 100A$ $R_G = 1\Omega \text{ (External)}$		54	ns
t_r			40	ns
$t_{d(off)}$			90	ns
t_f			40	ns
$Q_{g(on)}$	$V_{GS} = 10V, V_{DS} = 0.5 \cdot V_{DSS}, I_D = 0.5 \cdot I_{D25}$		400	nC
Q_{gs}			108	nC
Q_{gd}			116	nC
R_{thJC}			0.09	$^{\circ}C/W$
R_{thCS}		0.15		$^{\circ}C/W$

Source-Drain Diode

Symbol	Test Conditions	Characteristic Values		
		Min.	Typ.	Max.
I_S	$V_{GS} = 0V$			260 A
I_{SM}	Repetitive, Pulse Width Limited by T_{JM}			1040 A
V_{SD}	$I_F = 60A, V_{GS} = 0V, \text{Note 1}$			1.3 V
t_{rr}	$I_F = 130A, -di/dt = 100A/\mu s$ $V_R = 75V, V_{GS} = 0V$			200 ns
Q_{RM}			0.56	μC
I_{RM}			9.00	A

Note 1: Pulse Test, $t \leq 300\mu s$; Duty Cycle, $d \leq 2\%$.

ADVANCE TECHNICAL INFORMATION

The product presented herein is under development. The Technical Specifications offered are derived from a subjective evaluation of the design, based upon prior knowledge and experience, and constitute a "considered reflection" of the anticipated result. IXYS reserves the right to change limits, test conditions, and dimensions without notice.

IXYS Reserves the Right to Change Limits, Test Conditions, and Dimensions.

IXYS MOSFETs and IGBTs are covered 4,835,592 4,931,844 5,049,961 5,237,481 6,162,665 6,404,065 B1 6,683,344 6,727,585 7,005,734 B2 7,157,338B2
by one or more of the following U.S. patents: 4,850,072 5,017,508 5,063,307 5,381,025 6,259,123 B1 6,534,343 6,710,405 B2 6,759,692 7,063,975 B2
4,881,106 5,034,796 5,187,117 5,486,715 6,306,728 B1 6,583,505 6,710,463 6,771,478 B2 7,071,537

TO-264 (IXFK) Outline

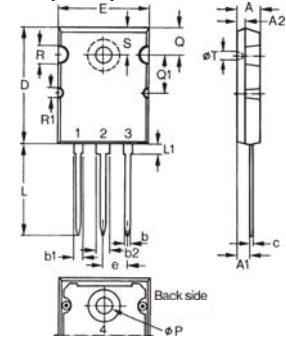

Dim.	Millimeter		Inches	
	Min.	Max.	Min.	Max.
A	4.82	5.13	.190	.202
A1	2.54	2.89	.100	.114
A2	2.00	2.10	.079	.083
b	1.12	1.42	.044	.056
b1	2.39	2.69	.094	.106
b2	2.90	3.09	.114	.122
c	0.53	0.83	.021	.033
D	25.91	26.16	1.020	1.030
E	19.81	19.96	.780	.786
e	5.46 BSC		.215 BSC	
J	0.00	0.25	.000	.010
K	0.00	0.25	.000	.010
L	20.32	20.83	.800	.820
L1	2.29	2.59	.090	.102
P	3.17	3.66	.125	.144
Q	6.07	6.27	.239	.247
Q1	8.38	8.69	.330	.342
R	3.81	4.32	.150	.170
R1	1.78	2.29	.070	.090
S	6.04	6.30	.238	.248
T	1.57	1.83	.062	.072

PLUS 247™ (IXFX) Outline

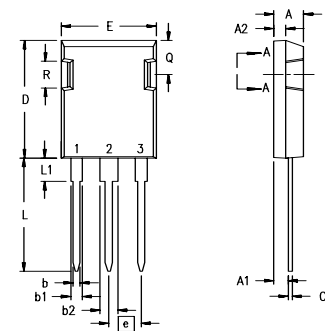

Terminals: 1 - Gate
2 - Drain (Collector)
3 - Source (Emitter)
4 - Drain (Collector)

Dim.	Millimeter		Inches	
	Min.	Max.	Min.	Max.
A	4.83	5.21	.190	.205
A ₁	2.29	2.54	.090	.100
A ₂	1.91	2.16	.075	.085
b	1.14	1.40	.045	.055
b ₁	1.91	2.13	.075	.084
b ₂	2.92	3.12	.115	.123
C	0.61	0.80	.024	.031
D	20.80	21.34	.819	.840
E	15.75	16.13	.620	.635
e	5.45 BSC		.215 BSC	
L	19.81	20.32	.780	.800
L1	3.81	4.32	.150	.170
Q	5.59	6.20	.220	0.244
R	4.32	4.83	.170	.190

Fig. 1. Output Characteristics @ 25°C

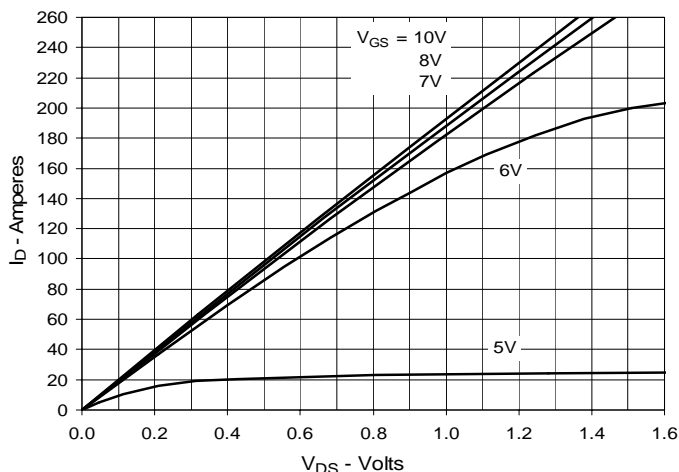

Fig. 2. Extended Output Characteristics @ 25°C

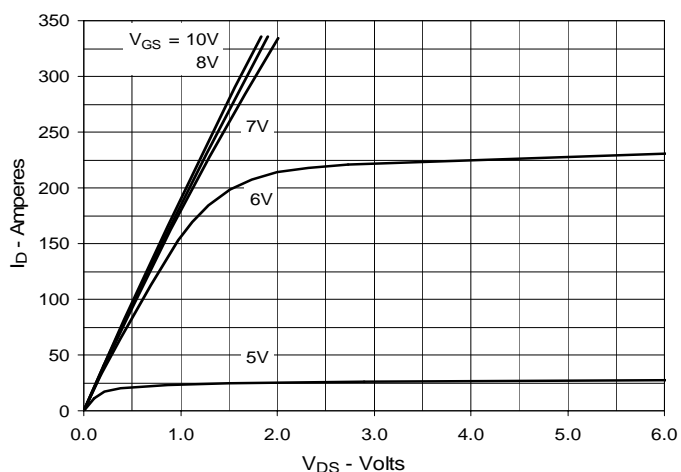

Fig. 3. Output Characteristics @ 150°C

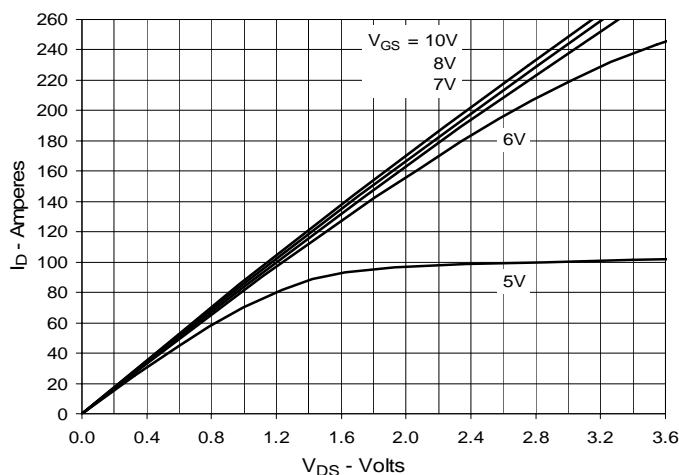

Fig. 4. $R_{DS(on)}$ Normalized to $I_D = 130A$ Value vs. Junction Temperature

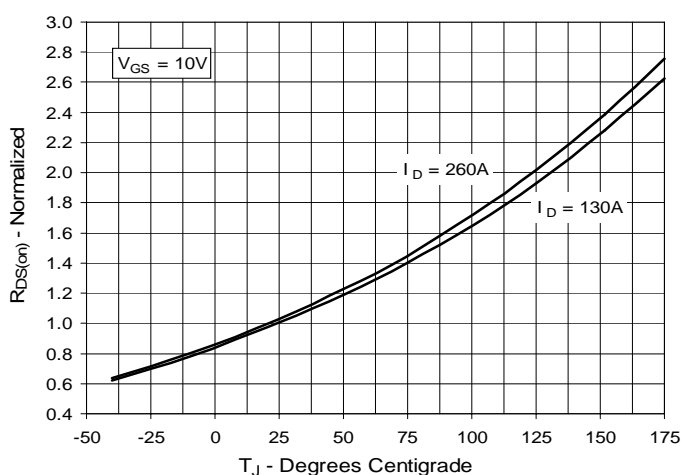

Fig. 5. $R_{DS(on)}$ Normalized to $I_D = 130A$ Value vs. Drain Current

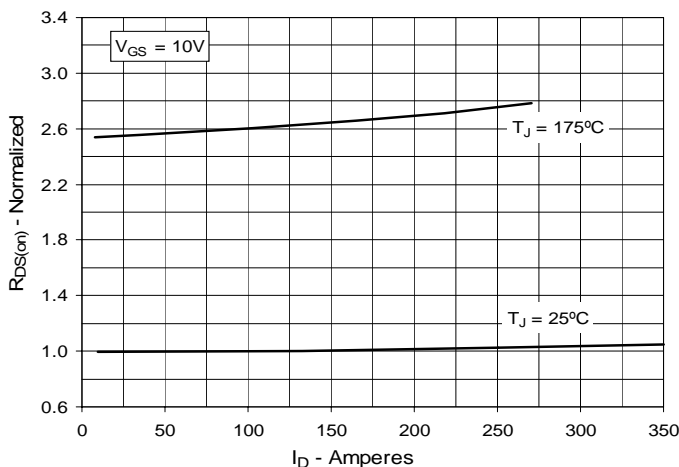

Fig. 6. Maximum Drain Current vs. Case Temperature

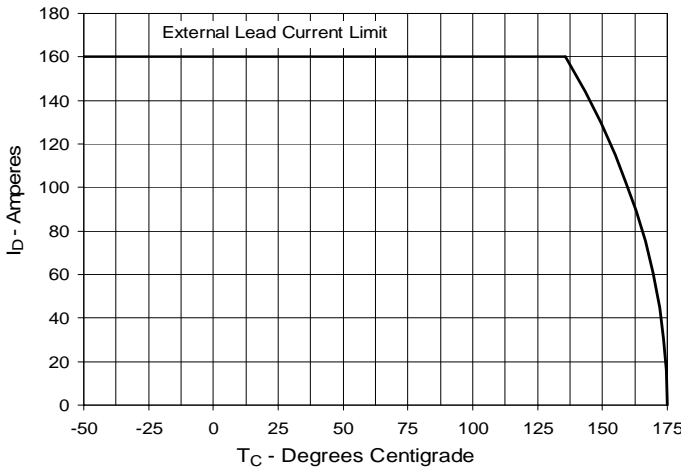

Fig. 7. Input Admittance

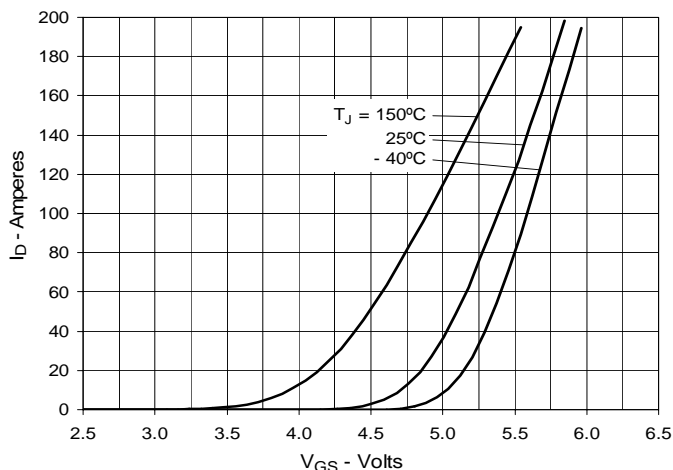

Fig. 8. Transconductance

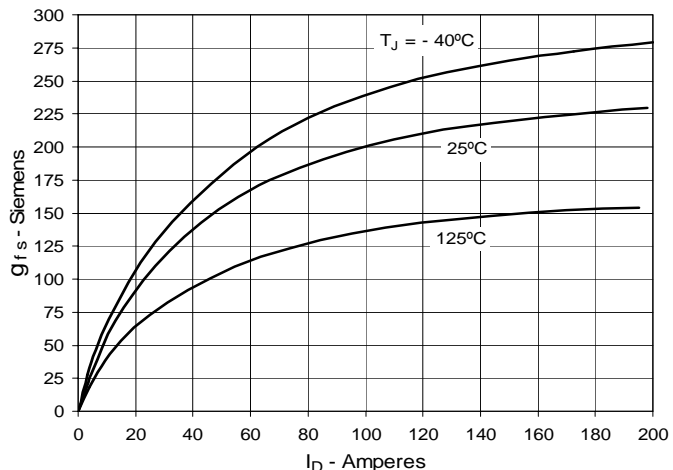

Fig. 9. Forward Voltage Drop of Intrinsic Diode

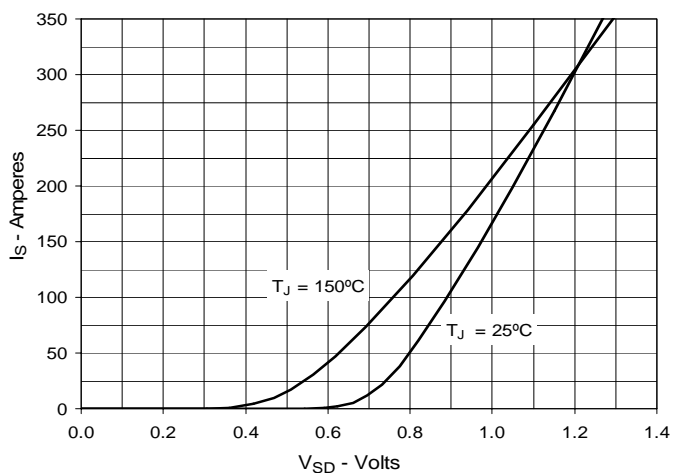

Fig. 10. Gate Charge

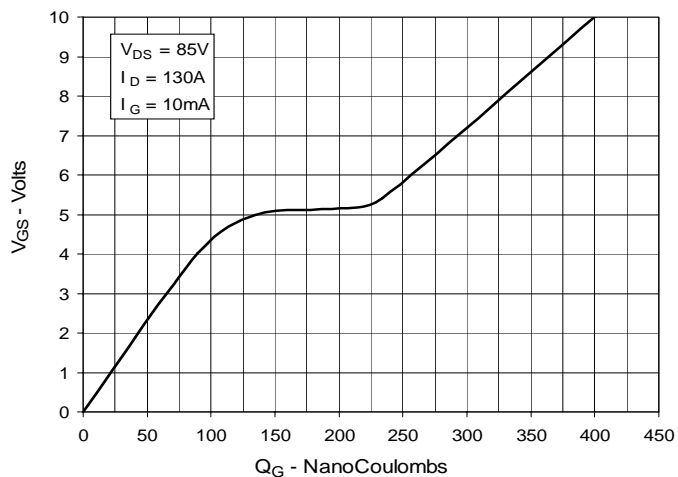

Fig. 11. Capacitance

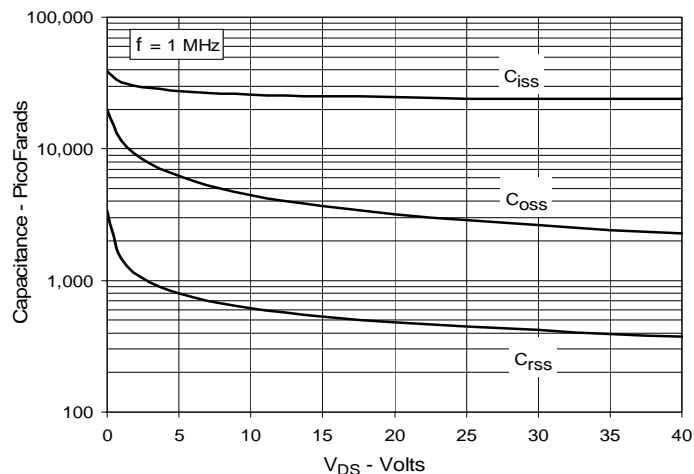

Fig. 12. Forward-Bias Safe Operating Area

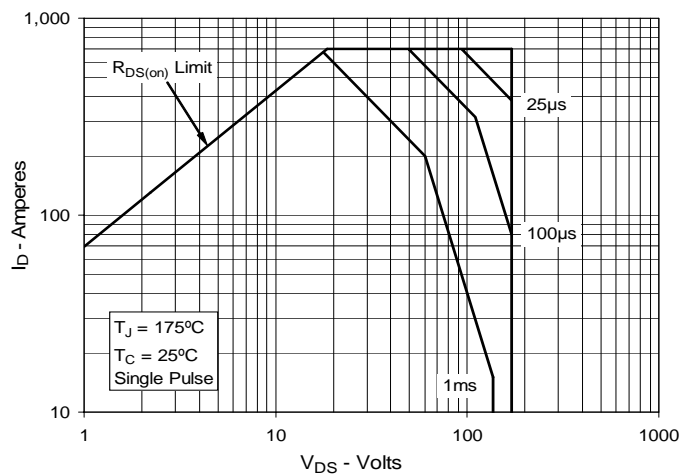

Fig. 13. Maximum Transient Thermal Impedance

