

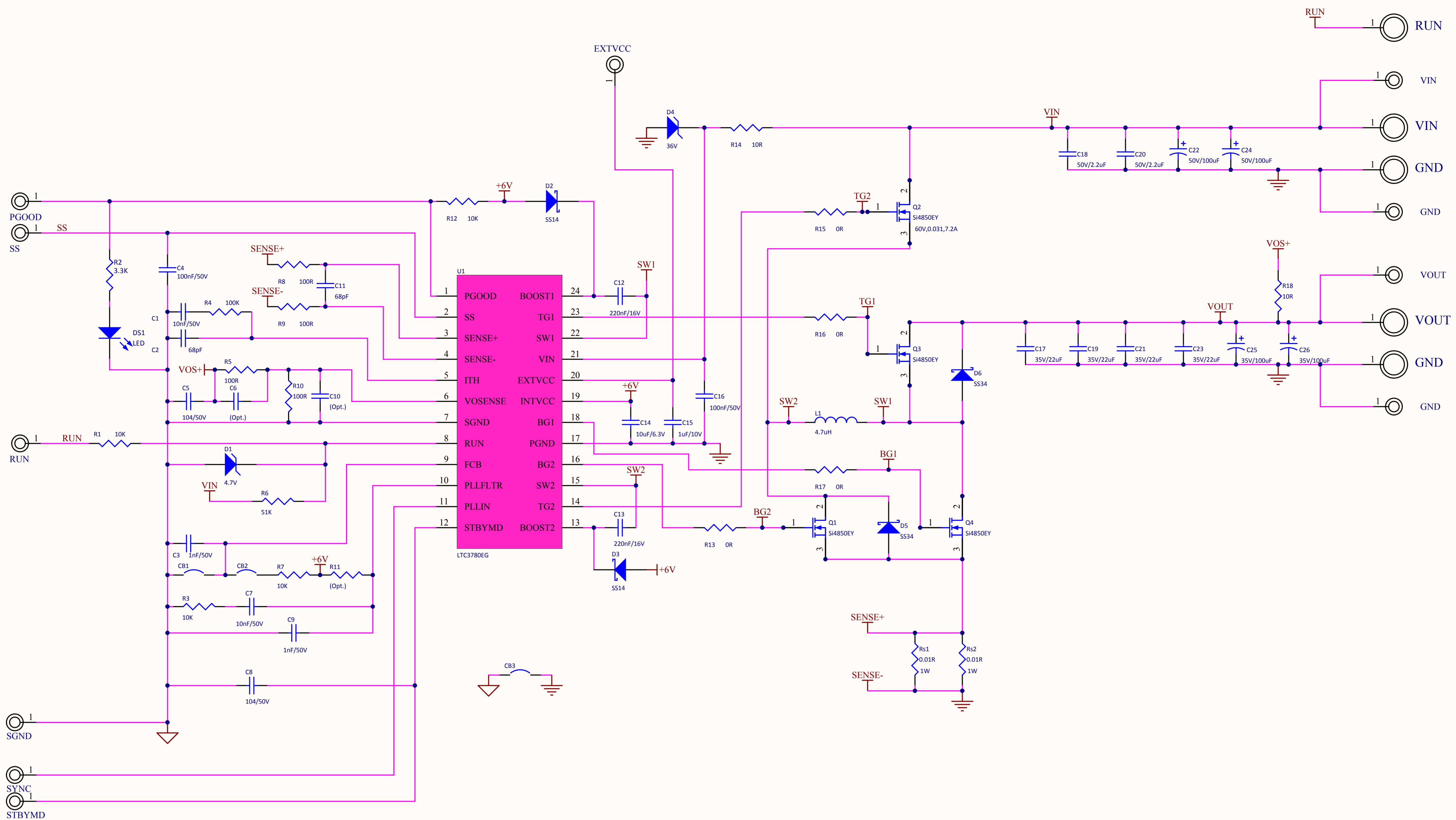

		PLACE LOGO HERE	
ENGINEER:	TITLE: Custom Made Board		
PHONE:			
ENGINEER:	PART NO.:	REV: 01	DATE: 2009-6-20
PHONE:			
FILE NAME:	70W_24V.PCBDOC	LAYER: Mechanical4	GERBER: .GBL





产品名称		产品项目		 长沙恒特电子科技有限公司
产品名称		项目名称		
设计	日期	文件编号	文件编号	
审核		版本号	版本号	
		70W 24V. SchDoc		第 0 页   共 0 页

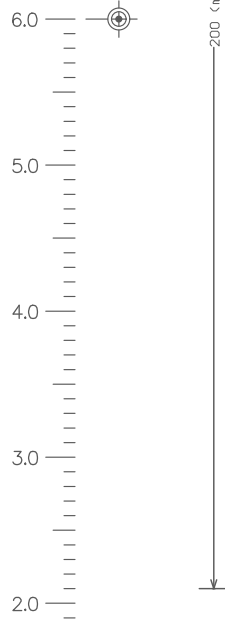

200 (mm)

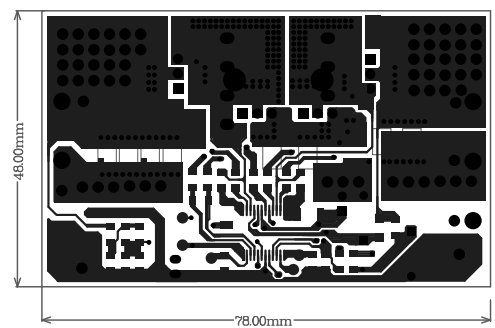

X Y

ENGINEER:		TITLE: Custom Made Board		PLACE LOGO HERE	
PHONE:		PART NO:		REV: 01	DATE: 2009-6-20
ENGINEER:		LAYER: Mechanical4		GERBER: .GTL	
PHONE:		FILE NAME: 70W_24V.PCBD0C			

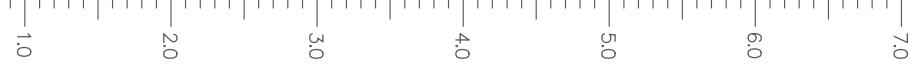

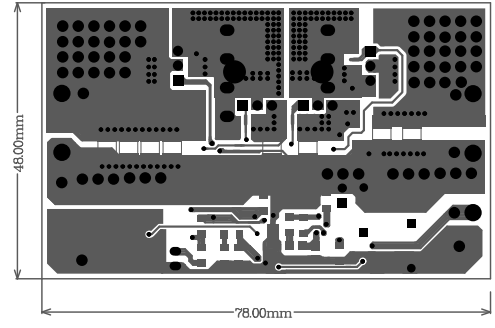
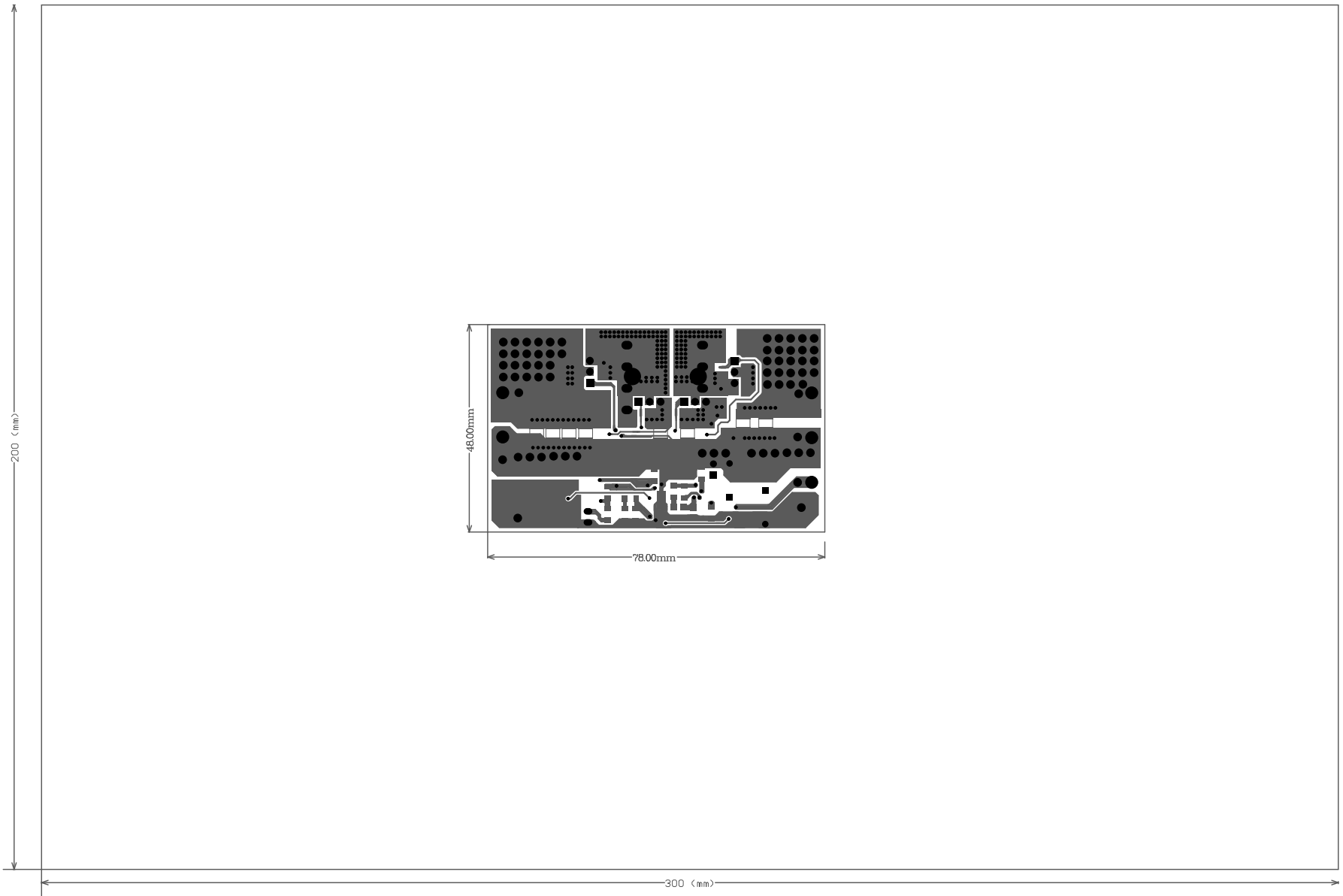
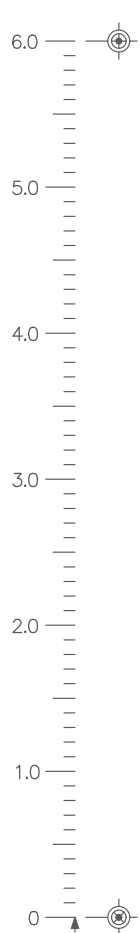

ENGINEER:		TITLE: Custom Made Board		PLACE LOGO HERE	
PHONE:		PART NO:		REV: 01	DATE: 2009-6-20
ENGINEER:		LAYER: Mechanical4		GERBER: .GBL	
PHONE:		FILE NAME: 70W_24V.PCBD0C			

