Contents

1	Main characteristics and circuit description	4
2	Electrical diagram and bill of material	6
3	Test results and significant waveforms	9
3.1	Harmonic content measurement	9
4	Thermal measurements	14
5	Conducted emission pre-compliance test	15
6	Burst test	16
7	Schematic with output voltage and current loop	17
8	Power transformer specification	19
9	References	20
10	Revision history	21

List of figures

Figure 1.	EVL6562A-35WFLB demonstration board using the L6562A	1
Figure 2.	EVL6562A-35WFLB demonstration board: electrical schematic	6
Figure 3.	EVL6562A-35WFLB compliance with EN61000-3-2 Class-C limits @ full load	9
Figure 4.	EVL6562A-35WFLB compliance with JEIDA-MITI Class-C limits @ full load	9
Figure 5.	Power factor vs. V_{IN} and load	9
Figure 6.	EVL6562A-35WFLB input current waveform @ 100 V-50 Hz - 35 W load	10
Figure 7.	EVL6562A-35WFLB input current waveform @ 230 V-50 Hz - 35 W load	10
Figure 8.	Efficiency vs. V_{IN} and load	10
Figure 9.	Static V_{OUT} regulation vs. V_{IN} and I_{OUT}	10
Figure 10.	EVL6562A-35WFLB output voltage ripple @ 90 V_{AC} - full load	11
Figure 11.	EVL6562A-35WFLB output voltage ripple @ 265 V_{AC} - full load	11
Figure 12.	EVL6562A-35WFLB V_{DS} and I_D @ 90 V_{AC} - full load	11
Figure 13.	EVL6562A-35WFLB V_{DS} and I_D @ 90 V_{AC} - full load - detail.	11
Figure 14.	EVL6562A-35WFLB V_{DS} and I_D @ 265 V_{AC} - full load	12
Figure 15.	EVL6562A-35WFLB V_{DS} and I_D @ 265 V_{AC} - full load - detail.	12
Figure 16.	EVL6562A-35WFLB V_{DS} and I_D @ 90 V_{AC} - 40 mA	12
Figure 17.	EVL6562A-35WFLB V_{DS} and I_D @ 90 V_{AC} - 40 mA - detail.	12
Figure 18.	EVL6562A-35WFLB V_{DS} and I_D @ 265 V_{AC} - 40 mA	13
Figure 19.	EVL6562A-35WFLB V_{DS} and I_D @ 265 V_{AC} - 40 mA - detail.	13
Figure 20.	Thermal map at 90 V_{AC} - full load.	14
Figure 21.	Thermal map at 265 V_{AC} - full load.	14
Figure 22.	115 V_{AC} and full load - phase	15
Figure 23.	115 V_{AC} and full load - neutral	15
Figure 24.	230 V_{AC} and full load - phase	15
Figure 25.	230 V_{AC} and full load - neutral	15
Figure 26.	Burst pulse and characteristics	16
Figure 27.	Electrical schematic with secondary current feedback	17
Figure 28.	Power transformer	19

1 Main characteristics and circuit description

The main characteristics of the SMPS demonstration board are:

- Line voltage range: 90 to 265 V_{AC}
- Minimum line frequency (f_L): 47-63 Hz
- Regulated output voltage: 48 V
- Rated output power: 35 W
- Power factor (load = 50 %): 0.9 minimum
- Minimum efficiency: 85 % at full load
- Maximum 2 f_L output voltage ripple: 1.5 V pk-pk / 0.39 V_{RMS} (@ V_{IN} = 90 V_{AC}, P_{OUT} = 35 W)
- Maximum ambient temperature: 50 °C
- Conducted EMI: In acc. with EN55022 Class-B
- Surge rejection: surge test 2.5 kV
- Primary to secondary insulation: 4 kV
- PCB type and size: double-sided, 35 µm, FR-4, 120 x 82 mm

The main feature of this converter is that the input current is almost in phase with the mains voltage, therefore the power factor is close to unity. This is achieved by the L6562A controller, which shapes the input current as a sinewave in phase with the mains voltage.

The power supply utilizes a typical flyback converter topology, using a transformer to provide the required insulation between the primary and secondary side. The converter is connected after the mains rectifier and the capacitor filter, which in this case is quite small to avoid damage to the shape of the input current. The flyback switch is represented by the power MOSFET Q1, and driven by the L6562A.

At startup, the L6562A is powered by the V_{CC} capacitor (C6), which is charged via resistors R1 and R2. The TR1 auxiliary winding (pins 8-7) generates the V_{CC} voltage, rectified by D4 and R4, that powers the L6562A during normal operation. R3 is also connected to the auxiliary winding to provide the transformer demagnetization signal to the L6562A ZCD pin, turning on the MOSFET at any switching cycle. The MOSFET used is the STP5NK80ZFP, a standard, low-cost 800 V device housed in a TO-220FP package, and needing only a small heat sink. The transformer is layer type, using a standard ferrite size ETD-29 and is manufactured by Magnetics. The flyback reflected voltage is ~190 V, providing enough room for the leakage inductance voltage spike still within the reliability margin of the MOSFET. The rectifier D2 and the Transil D3 clamp the peak of the leakage inductance voltage spike at MOSFET turn-off.

The resistors R14 and R15 sense the current flowing into the transformer primary side. Once the signal at the current sense pin has reached the level programmed by the internal multiplier of the L6562A, the MOSFET turns off.

The divider R7, R8, R9 and R6 provides to the L6562A multiplier pin with instantaneous voltage information which is used to modulate the current flowing into the transformer primary side.

The divider R20 and R21 is dedicated to sensing the output voltage, and capacitor C16 and diodes D7 and D8 provide a soft-start at turn-on. Output regulation is done by means of an

isolated voltage loop by the optocoupler U2, and using an inexpensive TL431 (U3) to drive the optocoupler. The opto-transistor modulates the input voltage of the L6562A internal amplifier, thus closing the voltage loop.

The output rectifier is a fast recovery type, selected according to its maximum reverse voltage, forward voltage drop and power dissipation. A small LC filter is added on the output, filtering the high frequency ripple.

The board is equipped with an input EMI filter designed for a 3-wire input mains plug. It is composed of two, common mode Pi-filter stages connected after the input connector and the input fuse. A varistor is also connected at the input of the board, improving immunity against input voltage fast transients.

2 Electrical diagram and bill of material

Figure 2. EVL6562A-35WFLB demonstration board: electrical schematic

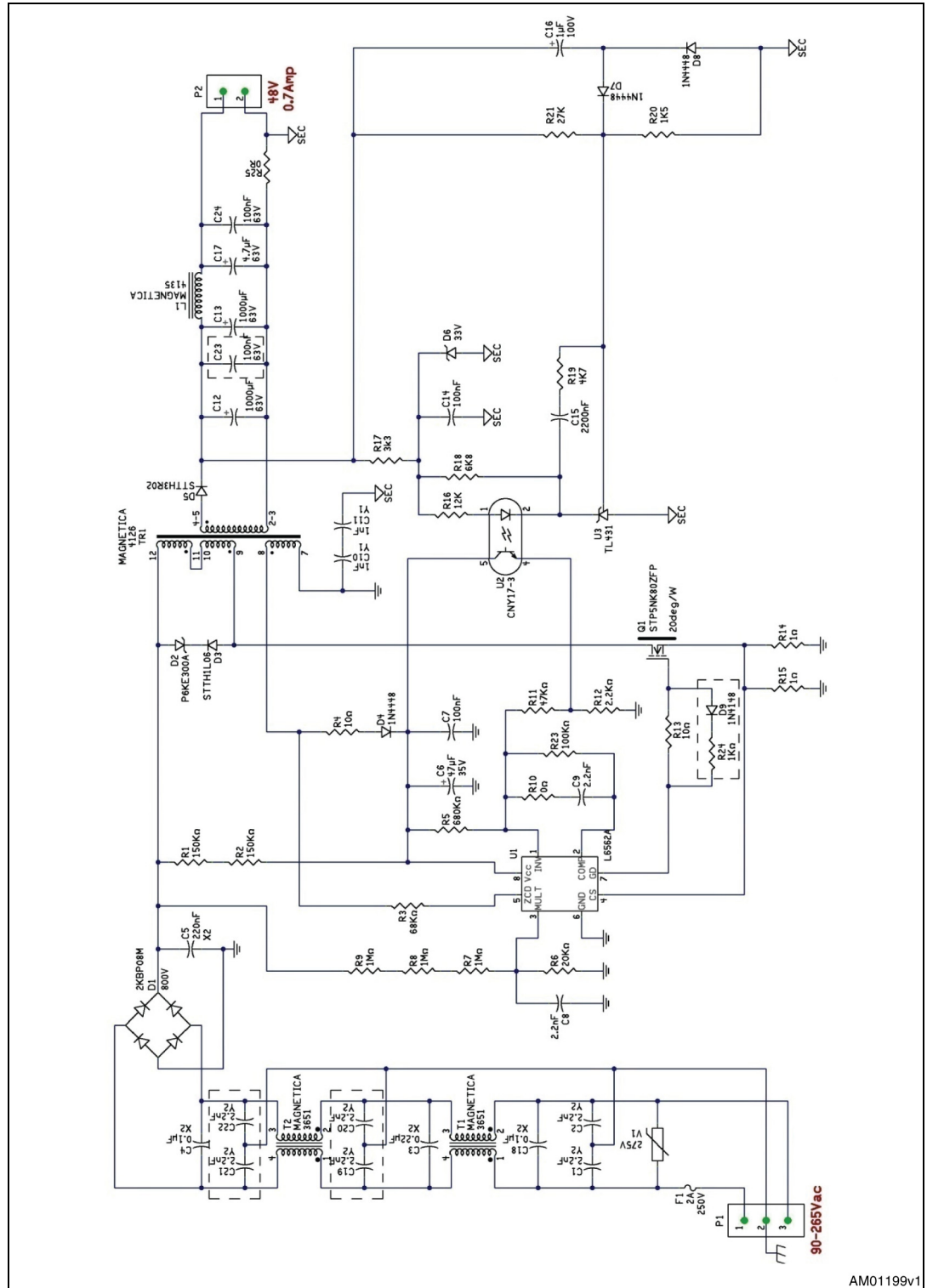

AM01199v1

Table 1. Bill of material

Reference	Part value	Type/description	Supplier
C1	2.2 nF	Ceramic Y2	Murata
C2	2.2 nF	Ceramic Y2	Murata
C3	0.22 μ F	R.46 275 V _{AC}	Arcotronics
C4	0.1 μ F	R.41 MKP Y2/X1 300 V _{AC}	n.d.
C5	220 nF	MKT X2 275 V _{AC}	n.d.
C6	47 μ F	35 V	n.d.
C7	100 nF	Ceramic	n.d.
C8	2.2 nF	Ceramic	n.d.
C9	2.2 nF	Ceramic	n.d.
C10	1 nF	Ceramic Y2	Murata
C11	1 nF	Ceramic Y2	Murata
C12	1000 μ F	63 V 105 °C YXF	Rubycon
C13	1000 μ F	63 V 105 °C YXF	Rubycon
C14	100 nF	Ceramic	n.d.
C15	2200 nF	Ceramic	n.d.
C16	1 μ F	100 V	n.d.
C17	4.7 μ F	63 V 105°C	Rubycon
C18	0.1 μ F	R.41 MKP Y2/X1 300 V _{AC}	n.d.
C19	2.2 nF	Ceramic Y2	Murata
C20	2.2 nF	Ceramic Y2	Murata
C21	2.2 nF	Ceramic Y2	Murata
C22	2.2 nF	Ceramic Y2	Murata
C23	100 nF	Ceramic	n.d.
C24	100 nF	Ceramic	n.d.
D1	800 V, 2 A	2KBP08M diode bridge	n.d.
D2	P6KE300A	Transil	STMicroelectronics
D3	STTH1L06	Rectifier, ultra-fast 1 A, 600 V	STMicroelectronics
D4	1N4448		n.d.
D5	STTH3R02	Rectifier, ultra-fast 3 A, 200 V	STMicroelectronics
D6	33 V	Zener, 5%	n.d.
D7	1N4448		n.d.
D8	1N4448		n.d.
D9	1N4148		n.d.
F1	2 A, 250 V	Fuse PCB mounting	n.d.

Table 1. Bill of material (continued)

Reference	Part value	Type/description	Supplier
L1	4135	Filter inductor 15 μ H/3 A	Magnetica
Q1	STP5NK80ZFP	Power MOSFET, TO-220FP w/heatsink	STMicroelectronics
R1	150 k Ω	Axial	n.d.
R2	150 k Ω	Axial	n.d.
R3	68 k Ω	Axial	n.d.
R4	10 R	Axial	n.d.
R5	680 k Ω	Axial	n.d.
R6	20 k Ω	Axial	n.d.
R7	1 M Ω	Axial	n.d.
R8	1 M Ω	Axial	n.d.
R9	1 M Ω	Axial	n.d.
R10	0 R	shorted	n.d.
R11	47 k Ω	Axial	n.d.
R12	2.2 k Ω	Axial	n.d.
R13	10R	Axial	n.d.
R14	1R0	Axial, precision 5%, 1/4 W	n.d.
R15	1R0	Axial, precision 5%, 1/4 W	n.d.
R16	12K	Axial	n.d.
R17	3K3	Axial, 1/4 W	n.d.
R18	6.8 k Ω	Axial	n.d.
R19	4.7 k Ω	Axial	n.d.
R20	1K5	Axial, precision 1%	n.d.
R21	27 k Ω	Axial, precision 1%	n.d.
R23	100 k Ω	Axial	n.d.
R24	1 k Ω	Axial	n.d.
R25	0R	Shorted	
T1	3651	Common mode choke 2x18 mH	Magnetica
T2	3651	Common mode choke 2x18 mH	Magnetica
TR1	4126	Switch-mode transformer	Magnetica
U1	L6562A	TM PFC controller	STMicroelectronics
U2	CNY17-3	Optocoupler DIP-6	n.d.
U3	TL431	Voltage reference, TO-92	STMicroelectronics
V1	275 V	VDR 40J (10/1000 μ s) 7 mm	n.d.

3 Test results and significant waveforms

3.1 Harmonic content measurement

One of the main purposes of this converter is the correction of input current distortion, decreasing the harmonic contents below the limits of the actual regulation. Therefore, the board has been tested according to the European standard EN61000-3-2 Class-C and Japanese standard JEIDA-MITI Class-C, at full load and both nominal input voltage mains.

As shown in figures that follow, the circuit is capable of reducing the harmonics well below the limits of both regulations.

Figure 3. EVL6562A-35WFLB compliance with EN61000-3-2 Class-C limits @ full load

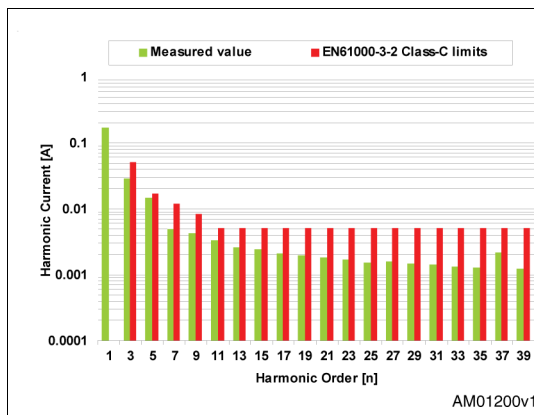
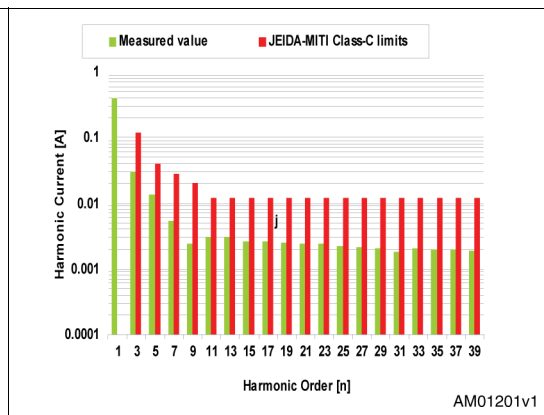
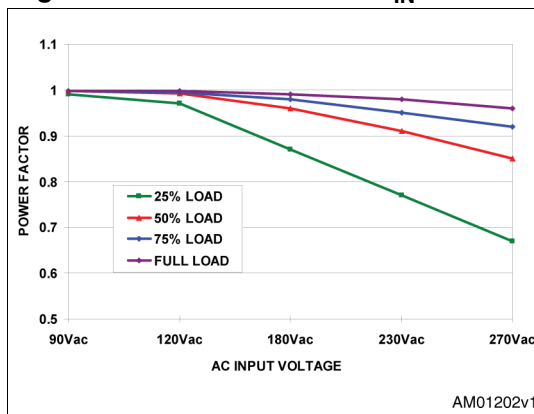

Figure 4. EVL6562A-35WFLB compliance with JEIDA-MITI Class-C limits @ full load



The power factor (PF) has been measured also and the results are reported in [Figure 5](#). As shown, the PF remains very close to unity throughout the input voltage mains range.

Figure 5. Power factor vs. V_{IN} and load



The waveforms of the input current and voltage at the nominal input voltage mains and full load condition are illustrated in [Figure 6](#) and [Figure 7](#).

Figure 6. EVL6562A-35WFLB input current waveform @100 V-50 Hz - 35 W load

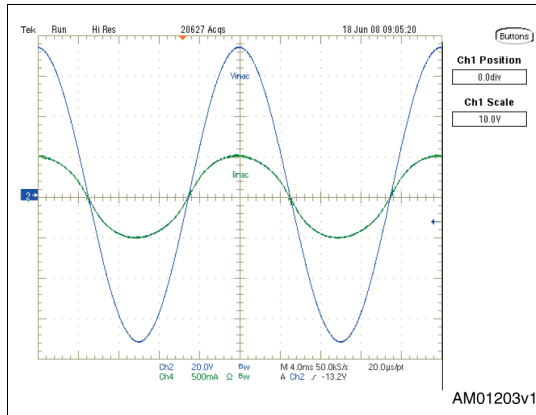
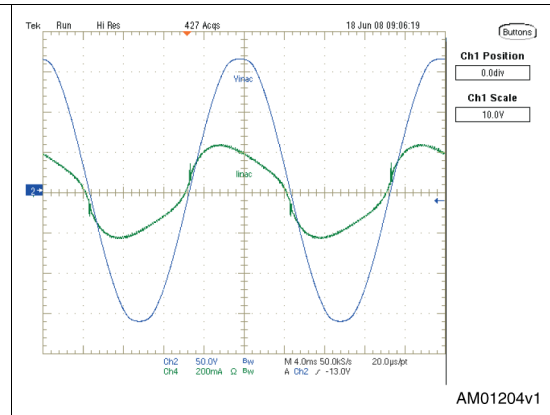

Figure 7. EVL6562A-35WFLB input current waveform @230 V-50 Hz - 35 W load



The converter’s efficiency has been measured and it is significantly high in all load and line conditions (see [Figure 8](#)). At full load, the efficiency is higher than 85% at any input voltage, making this design suitable for high efficiency power supplies. Also, at lower output load the efficiency is better than 82%. At minimum load (40 mA output current) the efficiency is still good.

[Figure 9](#) reports the output voltage measured under different line and load conditions. As shown, the voltage regulation over the entire input voltage range is excellent at any output current level.

Figure 8. Efficiency vs. V_{IN} and load

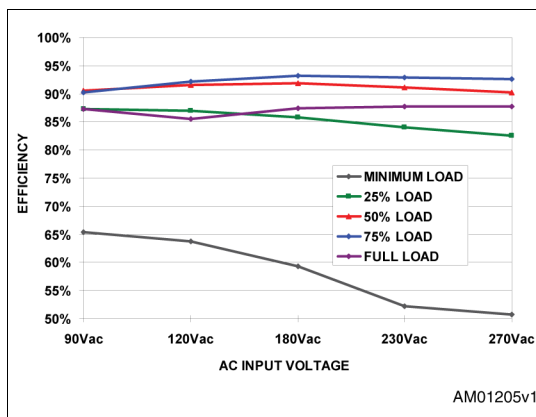

Figure 9. Static V_{OUT} regulation vs. V_{IN} and I_{OUT}

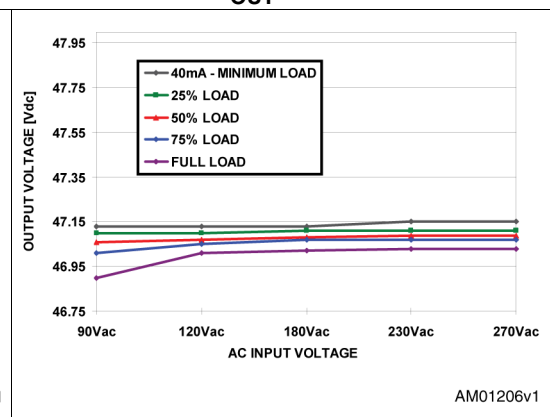

Figure 10. EVL6562A-35WFLB output voltage ripple @ 90 V_{AC} - full load

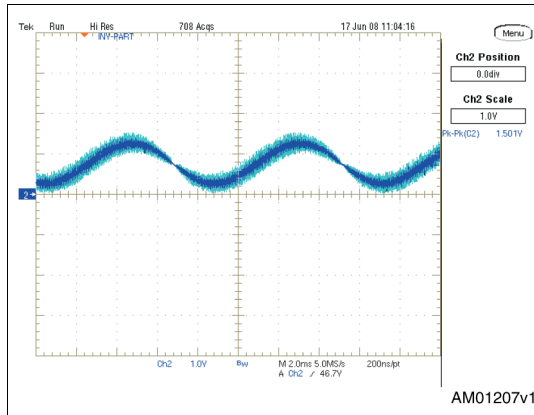
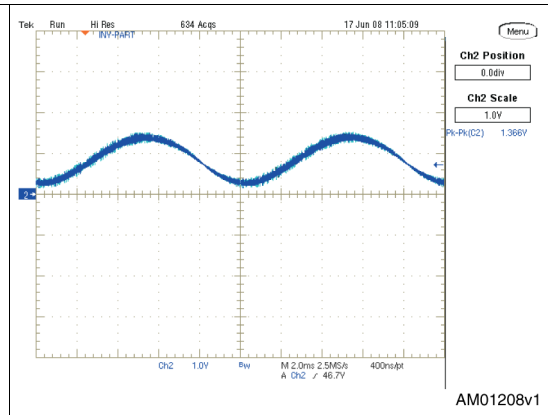

Figure 11. EVL6562A-35WFLB output voltage ripple @ 265 V_{AC} - full load



In *Figure 10* and *Figure 11* the output voltage ripple at twice the input mains frequency is measured. As shown it is less than 0.4 V peak-to-peak, which is ideal for LED or lighting applications. High frequency noise, including spikes, is significantly reduced as well.

In the following illustrations, the MOSFET drain voltage and current are measured at different line and maximum loads.

Figure 12. EVL6562A-35WFLB V_{DS} and I_D @ 90 V_{AC} - full load

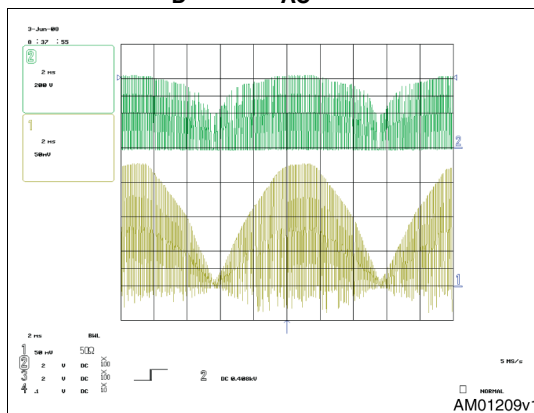

CH1: drain current - 0.5 A/div
CH2: drain voltage - 200 V/div

Figure 13. EVL6562A-35WFLB V_{DS} and I_D @ 90 V_{AC} - full load - detail

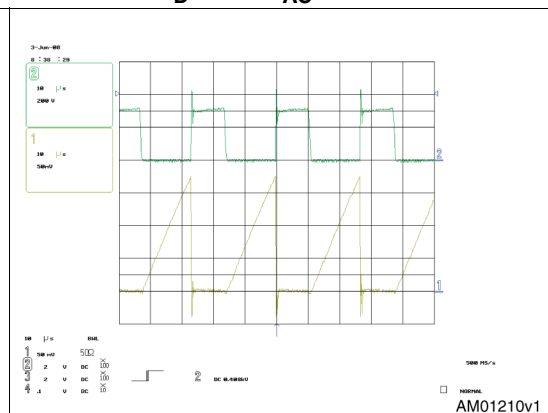

CH1: drain current - 0.5 A/div
CH2: drain voltage - 200 V/div

Figure 14. EVL6562A-35WFLB V_{DS} and I_D @ 265 V_{AC} - full load

Figure 15. EVL6562A-35WFLB V_{DS} and I_D @ 265 V_{AC} - full load - detail

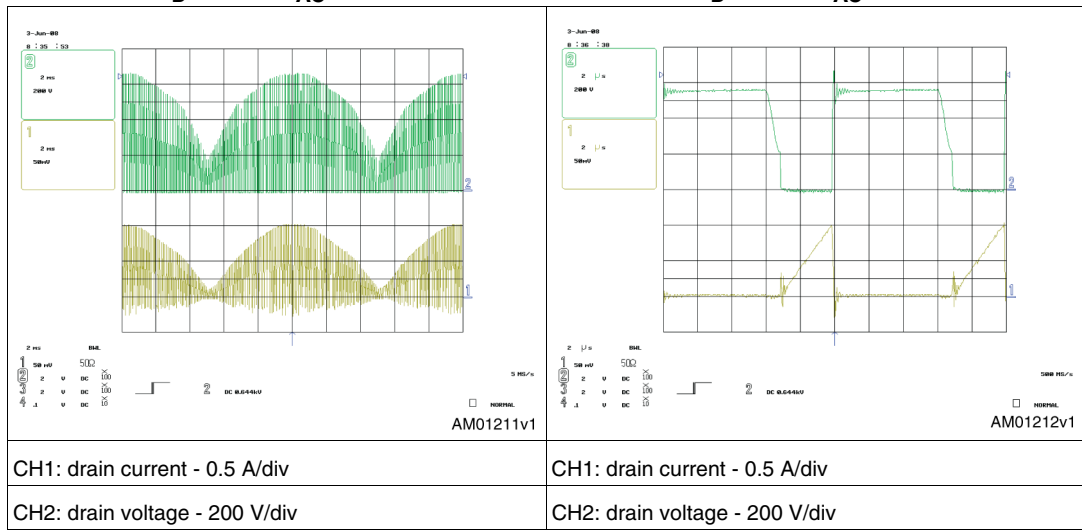

Figure 14 shows the measurement at the maximum drain voltage of 265 V_{AC} and max load. In this worst-case condition, the peak drain voltage is 640 V_{PK} , assuring a good margin with respect to the MOSFET BV_{DSS} and contributing strongly to the reliability and low failure rate of the design.

Figure 16. EVL6562A-35WFLB V_{DS} and I_D @ 90 V_{AC} - 40 mA

Figure 17. EVL6562A-35WFLB V_{DS} and I_D @ 90 V_{AC} - 40 mA - detail

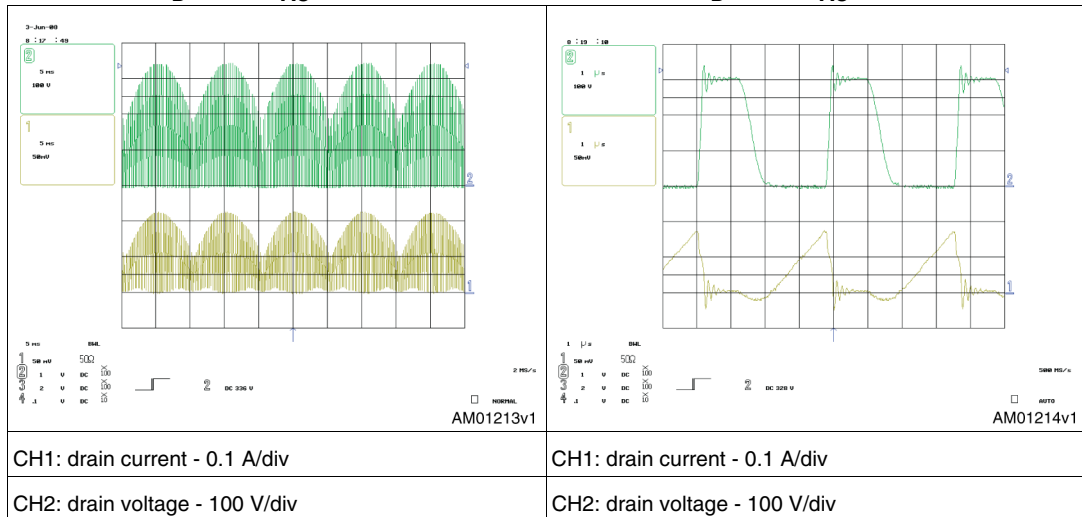
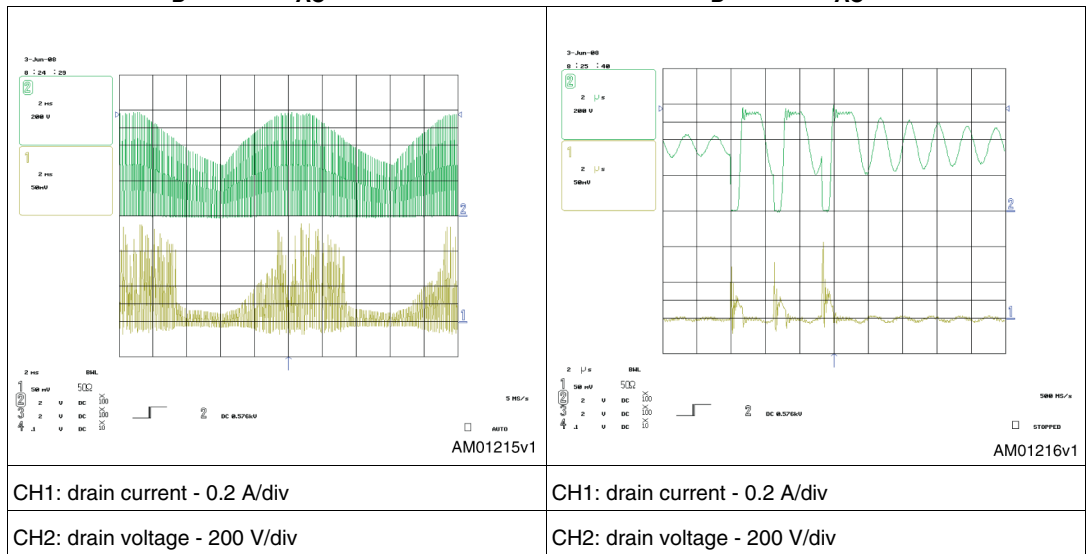

Figure 18. EVL6562A-35WFLB V_{DS} and I_D @ 265 V_{AC} - 40 mA

Figure 19. EVL6562A-35WFLB V_{DS} and I_D @ 265 V_{AC} - 40 mA - detail



The above figures show the MOSFET waveforms at light load. Even in this load condition the waveforms are correct. It can be noted that at high mains the converter works in burst mode (see [Figure 19](#)), keeping efficiency at a good level.

4 Thermal measurements

To check the reliability of the design, thermal mapping by means of an IR camera was carried out. [Figure 20](#) and [Figure 21](#) show thermal measurements on the component side of the board at nominal input voltages and full load. Some pointers visible on the pictures placed across key components show the relevant temperature. [Table 1](#) provides the correlation between the measured points and components, for both thermal maps. The ambient temperature during both measurements was 27 °C. According to these measurement results, all components on the board function within their temperature limits.

Figure 20. Thermal map at 90 V_{AC} - full load

Figure 21. Thermal map at 265 V_{AC} - full load

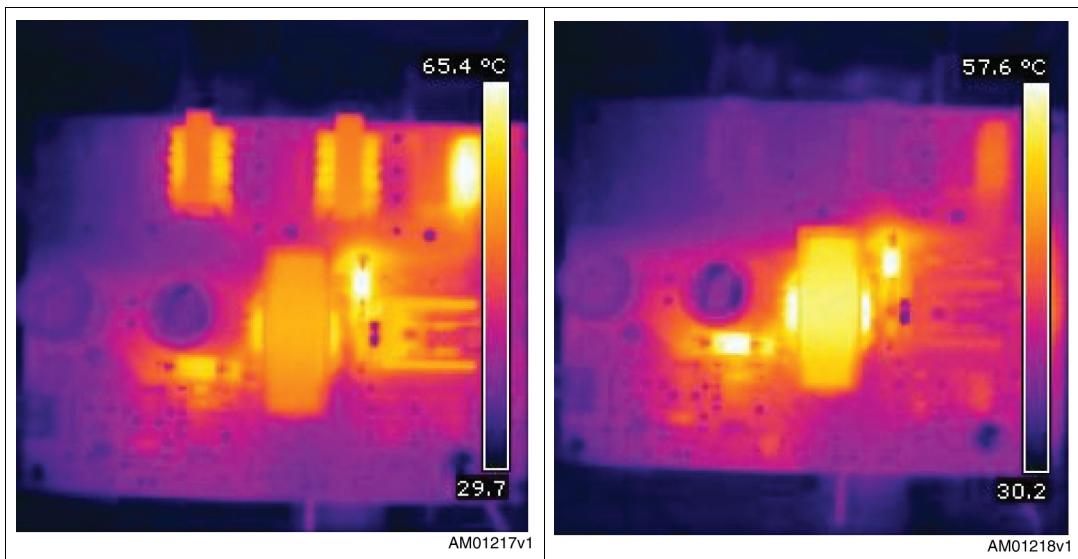

Table 2. Measured temperature @ 90 V_{AC} and 265 V_{AC} - full load

Component	Temperature @ 90 V _{AC}	Temperature @ 265 V _{AC}
MOSFET Q1	57.8 °C	43.8 °C
Secondary diode D5	58.9 °C	58.1 °C
Diode bridge D1	65.9 °C	45.6 °C
Transformer TR1 (bobbin)	64.3 °C	65.1 °C
Transformer TR1 (core)	54.5 °C	55 °C
Choke T1	55.7 °C	36.2 °C
Choke T2	56 °C	38.2 °C
Transil D2	70 °C	59 °C

5 Conducted emission pre-compliance test

The following images are the peak measurements of the conducted noise at full load and nominal mains voltages. The limits shown on the diagrams are those of EN55022 Class-B, which is the most popular standard for domestic equipment. As visible in the diagrams, good margins with respect to the limits are present in all test conditions.

Figure 22. 115 V_{AC} and full load - phase **Figure 23. 115 V_{AC} and full load - neutral**

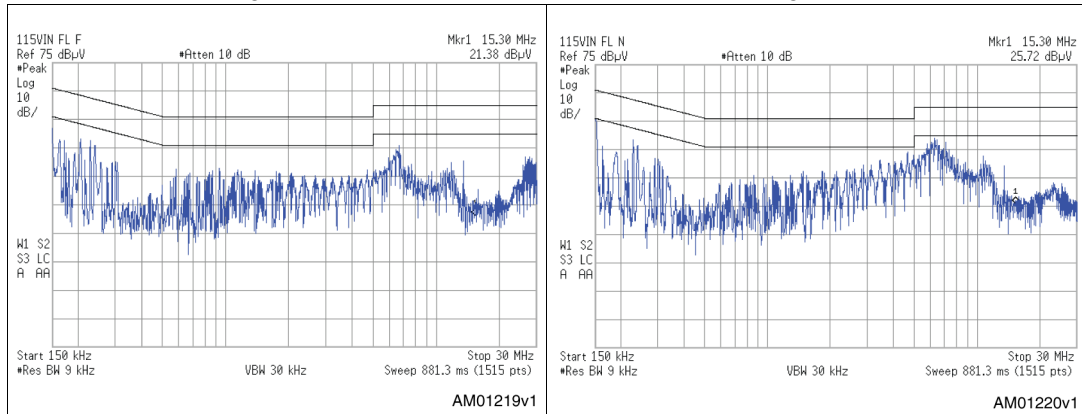
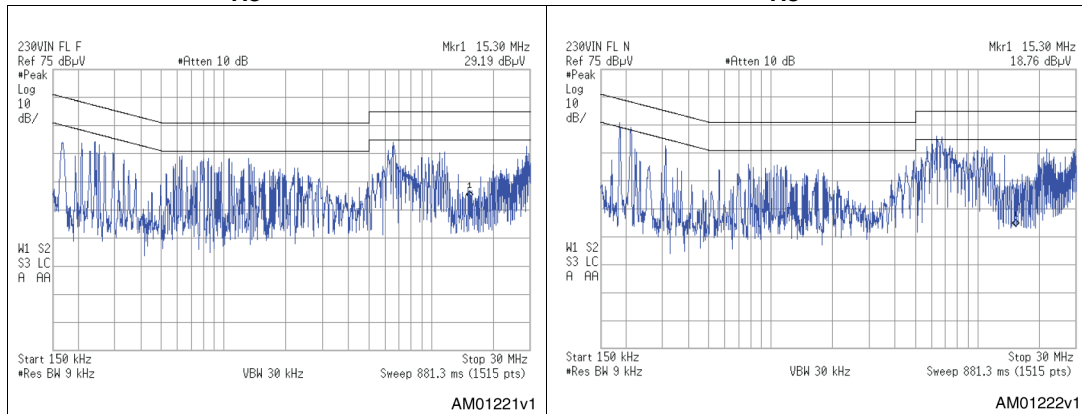

Figure 24. 230 V_{AC} and full load - phase **Figure 25. 230 V_{AC} and full load - neutral**



6 Burst test

The board has been tested against burst pulses, with good results. The tests have been carried out using the following equipment and the procedures:

- Surge generator: Schaffner NSG 200 E 7 NSG 224 A
- Test types:
 - SYM = symmetric with respect to earth pole (pulse applied between line and neutral)
 - ASYM = asymmetric (pulse applied between line and earth and between neutral and earth)
- Output load 700 mA.

Figure 26. Burst pulse and characteristics

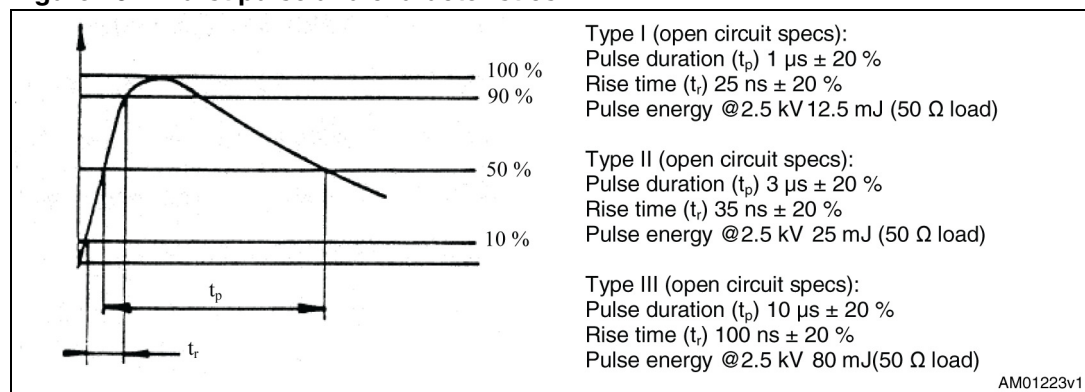

Table 3. Burst test report table

Configuration	Amplitude	Polarity and phase	Pulse type	Pulse frequency	Pulse number (burst)	Pause	Pulse number (burst)	Pause	Pulse number (burst)	Pause	Pulse number (burst)	Pause
SYM	2.5 kV	+ 90°	III	1 Hz	10	15"	10	15"	10	15"	10	15"
					10	15"						
SYM	2.5 kV	- 270°	III	1 Hz	10	15"	10	15"	10	15"	10	15"
					10	15"						
ASYM	2.5 kV	+ 90°	III	1 Hz	10	15"	10	15"	10	15"	10	15"
					10	15"						
ASYM	2.5 kV	- 270°	III	1 Hz	10	15"	10	15"	10	15"	10	15"
					10	15"						

- Test passed with a total of 200 pulses applied and a medium energy of 80 mJ (when connected to a 50 Ω load).

7 Schematic with output voltage and current loop

All tests described in this document have been done using the schematic in [Figure 1](#) and using a TL431 for the output voltage feedback. If a secondary current loop is also needed, the schematic below can be implemented on the PCB by making the modifications listed in [Table 4](#).

The proposed schematic has been designed to drive LEDs with a current rating of 700 mA. For correct board functionality the minimum output voltage when the current loop is working is around 30 V. Therefore, the minimum number of LEDs in series that can be connected to the output must be calculated according to this minimum output voltage value.

Figure 27. Electrical schematic with secondary current feedback

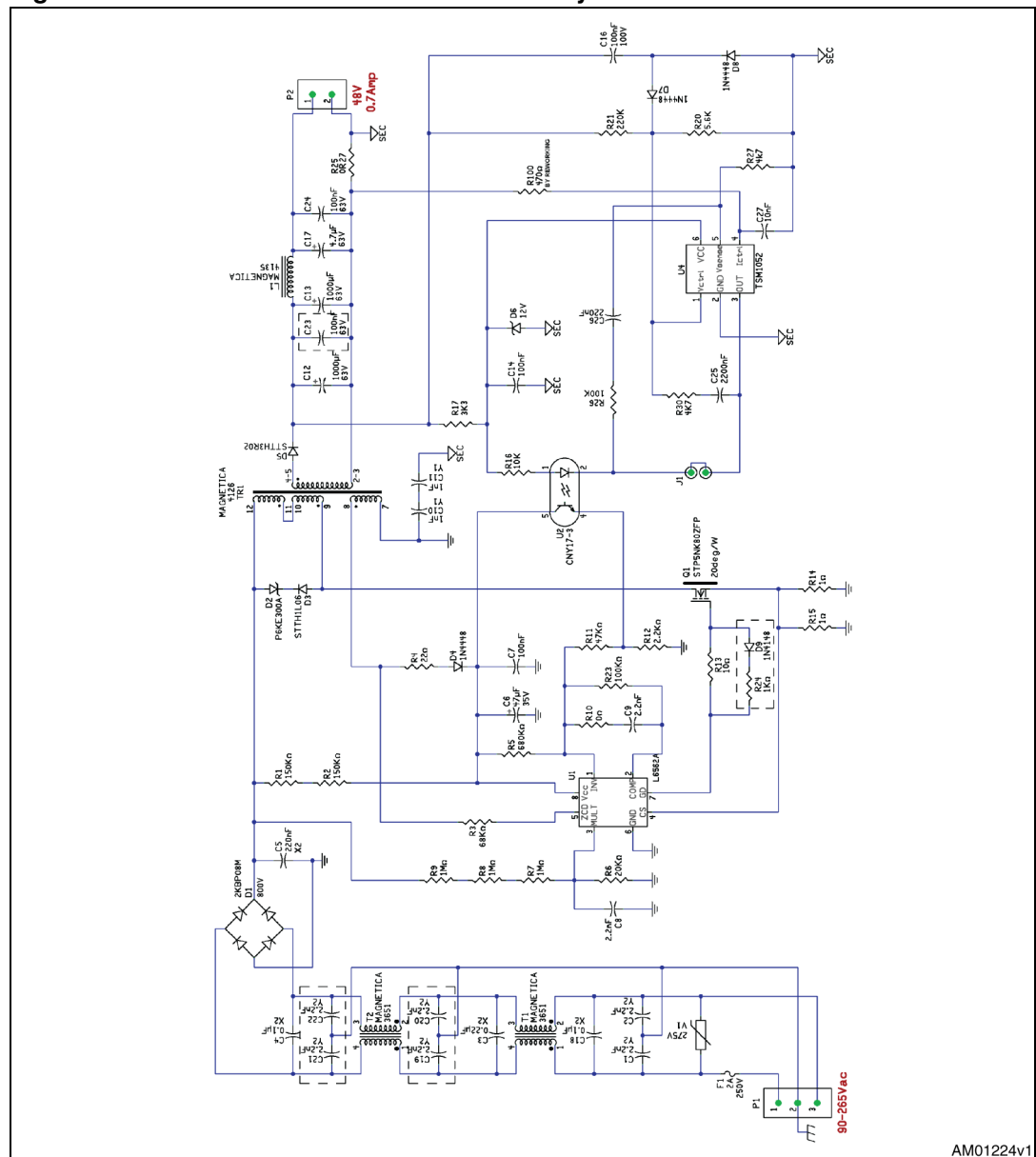

Table 4. Modification list for TSM1052 implementation

Reference	Part value	Modification	Type/ Description
C15		Removed	
C16	100 nF	Changed value	Ceramic
C25	2.2 nF	Added	Ceramic
C26	220 nF	Added	Ceramic
C27	10 nF	Added	Ceramic
D6	12 V	Changed value	Zener, 5%
R4	22 R	Changed value	Axial
R16	10 k Ω	Changed value	Axial
R18		Removed	
R19		Removed	
R20	5K6	Changed value	Axial, precision 1%
R21	220 k Ω	Changed value	Axial, precision 1%
R25	0R27	Added	Axial 2 W
R26	100 k Ω	Added	Axial
R27	4K7	Added	Axial
R30	4K7	Added	Axial
R100	470R	Mounted by reworking of PCB	Axial
J1	JUMPER	Added	Wire jumper
U3		Removed	
U4	TSM1052 STMicroelectronics	Added	Current/voltage controller

8 Power transformer specification

- Transformer type: open
 - Winding type: layer
 - Coil former: vertical type, 6 + 6 pins
 - Mains insulation: 4 kV
 - Unit finishing: varnished

Electrical characteristics (all measurements taken with pins 10 and 11 shorted)

- Converter topology: flyback, TM mode
- Core type: ETD29
- Min. operating frequency: 36 kHz
- Primary inductance: 550 H 10% @ 1 kHz - 0.25 V ^(a)
- Leakage inductance: 0.8% @ 50 kHz - 0.25 V ^(b)
- Parasitic capacitance: 7 pF max.
- Max. peak primary current: 1.9 A_{PK}
- Turn ratio:
 - Pin 9-12 / 8-7: 10.55 ± 5%
 - Pin 9-12 / 5/4-3/2: 3.8 ± 5%

Figure 28. Power transformer

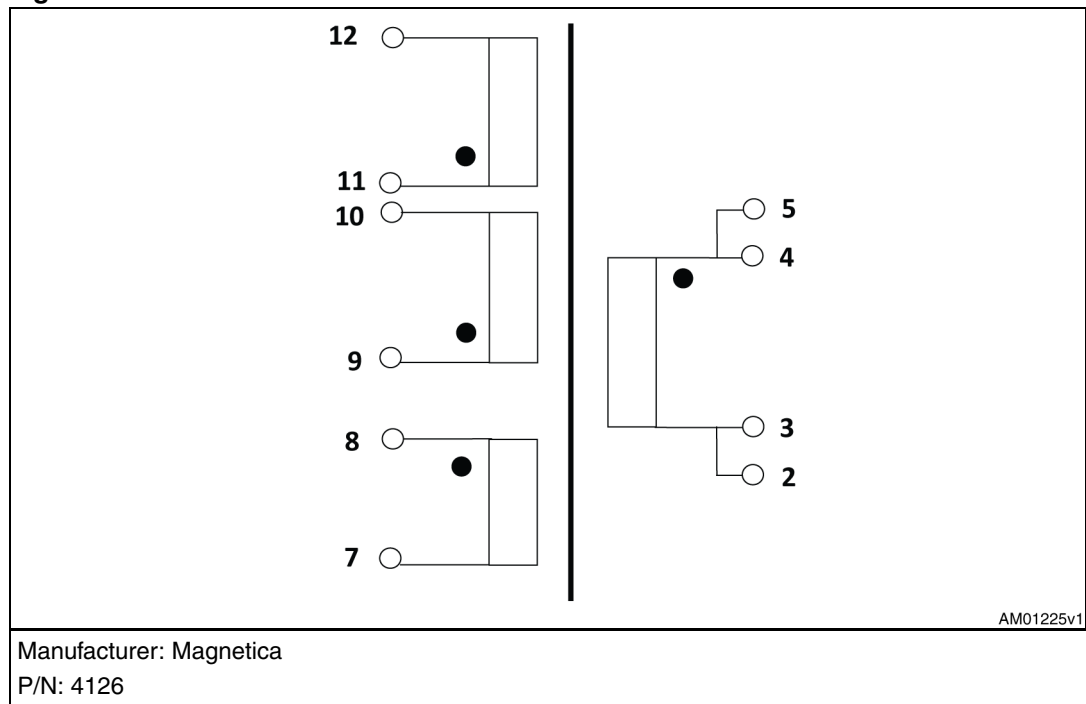

- a. Measured between pins (9-12)
- b. Measured between pins (9-12) with all secondary windings shorted

9 References

- L6562A transition-mode PFC controller datasheet
- Application note AN1059: Design equations of high-power-factor flyback converters based on the L6561
- Application note AN1060: Flyback converters with the L6561 PFC controller

10 Revision history

Table 5. Document revision history

Date	Revision	Changes
12-Nov-2008	1	Initial release

Please Read Carefully:

Information in this document is provided solely in connection with ST products. STMicroelectronics NV and its subsidiaries ("ST") reserve the right to make changes, corrections, modifications or improvements, to this document, and the products and services described herein at any time, without notice.

All ST products are sold pursuant to ST's terms and conditions of sale.

Purchasers are solely responsible for the choice, selection and use of the ST products and services described herein, and ST assumes no liability whatsoever relating to the choice, selection or use of the ST products and services described herein.

No license, express or implied, by estoppel or otherwise, to any intellectual property rights is granted under this document. If any part of this document refers to any third party products or services it shall not be deemed a license grant by ST for the use of such third party products or services, or any intellectual property contained therein or considered as a warranty covering the use in any manner whatsoever of such third party products or services or any intellectual property contained therein.

UNLESS OTHERWISE SET FORTH IN ST'S TERMS AND CONDITIONS OF SALE ST DISCLAIMS ANY EXPRESS OR IMPLIED WARRANTY WITH RESPECT TO THE USE AND/OR SALE OF ST PRODUCTS INCLUDING WITHOUT LIMITATION IMPLIED WARRANTIES OF MERCHANTABILITY, FITNESS FOR A PARTICULAR PURPOSE (AND THEIR EQUIVALENTS UNDER THE LAWS OF ANY JURISDICTION), OR INFRINGEMENT OF ANY PATENT, COPYRIGHT OR OTHER INTELLECTUAL PROPERTY RIGHT.

UNLESS EXPRESSLY APPROVED IN WRITING BY AN AUTHORIZED ST REPRESENTATIVE, ST PRODUCTS ARE NOT RECOMMENDED, AUTHORIZED OR WARRANTED FOR USE IN MILITARY, AIR CRAFT, SPACE, LIFE SAVING, OR LIFE SUSTAINING APPLICATIONS, NOR IN PRODUCTS OR SYSTEMS WHERE FAILURE OR MALFUNCTION MAY RESULT IN PERSONAL INJURY, DEATH, OR SEVERE PROPERTY OR ENVIRONMENTAL DAMAGE. ST PRODUCTS WHICH ARE NOT SPECIFIED AS "AUTOMOTIVE GRADE" MAY ONLY BE USED IN AUTOMOTIVE APPLICATIONS AT USER'S OWN RISK.

Resale of ST products with provisions different from the statements and/or technical features set forth in this document shall immediately void any warranty granted by ST for the ST product or service described herein and shall not create or extend in any manner whatsoever, any liability of ST.

ST and the ST logo are trademarks or registered trademarks of ST in various countries.

Information in this document supersedes and replaces all information previously supplied.

The ST logo is a registered trademark of STMicroelectronics. All other names are the property of their respective owners.

© 2008 STMicroelectronics - All rights reserved

STMicroelectronics group of companies

Australia - Belgium - Brazil - Canada - China - Czech Republic - Finland - France - Germany - Hong Kong - India - Israel - Italy - Japan - Malaysia - Malta - Morocco - Singapore - Spain - Sweden - Switzerland - United Kingdom - United States of America

www.st.com