

Description

SL71053 is a highly integrated solution for SMPS applications requiring CV (constant voltage) and CC (constant current) mode. SL71053 integrates one voltage reference, two operational amplifiers (with ORed outputs-common collectors), and a current sensing circuit. The voltage reference combined with one operational amplifier makes it an ideal voltage controller, and the other low voltage reference combined with the other operational amplifier makes it an ideal current limiter for output low side current sensing. the current threshold is fixed, and precise. the only external components are :

- a resistor bridge to be connected to the output of the power supply (adapter, battery charger) to set the voltage regulation by dividing the desired output voltage to match the internal voltage reference value.
- a sense resistor having a value and allowable dissipation power which need to be chosen according to the internal voltage threshold.
- optional compensation components. SL71053, housed in one of the smallest package available, is ideal for space shrink applications such as adapters and battery chargers.

Features

- Constant voltage & constant current control
- Wide operating voltage range (2.2V to 14V)
- Precision internal voltage reference (1.21V \pm 1.0%)
- Precision internal CC AMP reference (80mV Typ.)
- Low external component count
- Current sink output stage
- Easy compensation

Applications

- Adapters
- Battery chargers

Ordering Information

Type NO.	Marking	Package Code
SL71053	703	SOT - 26

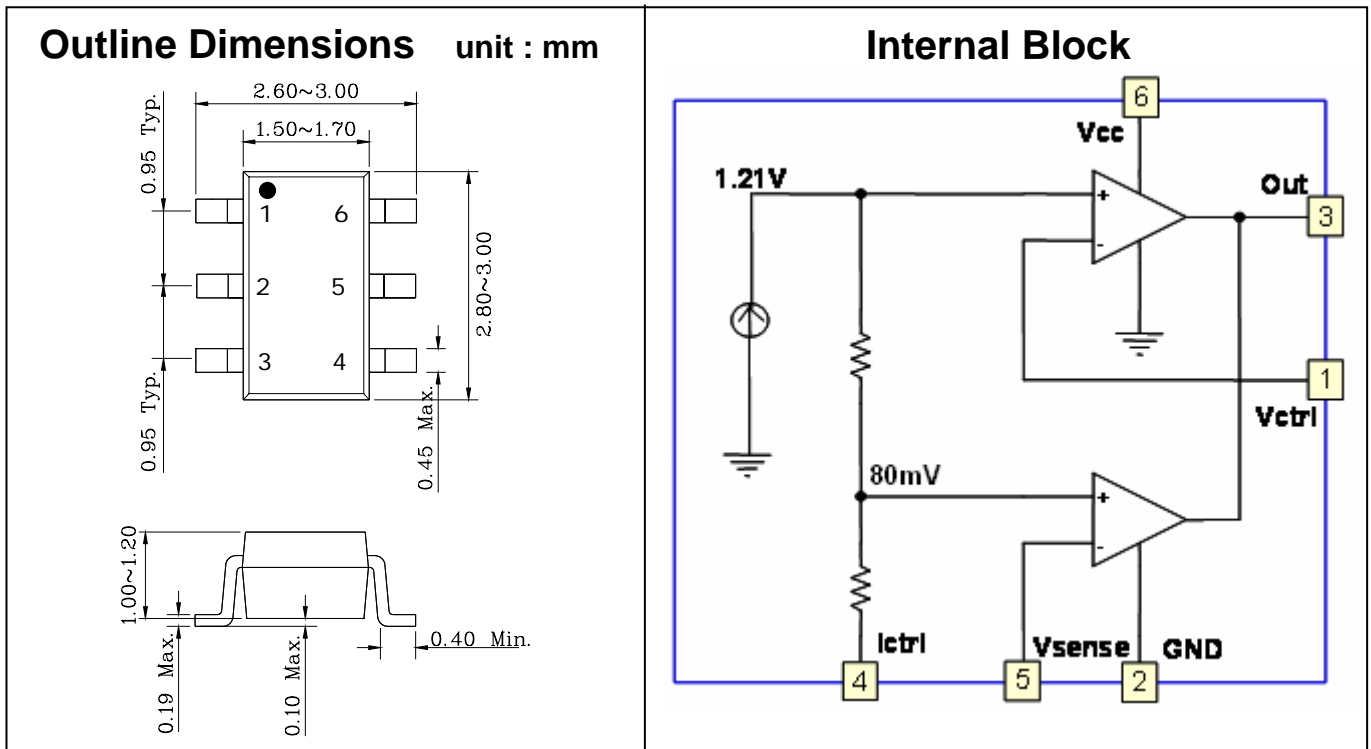

Typical Application : Adapter or Battery Charger Application Using SL71053

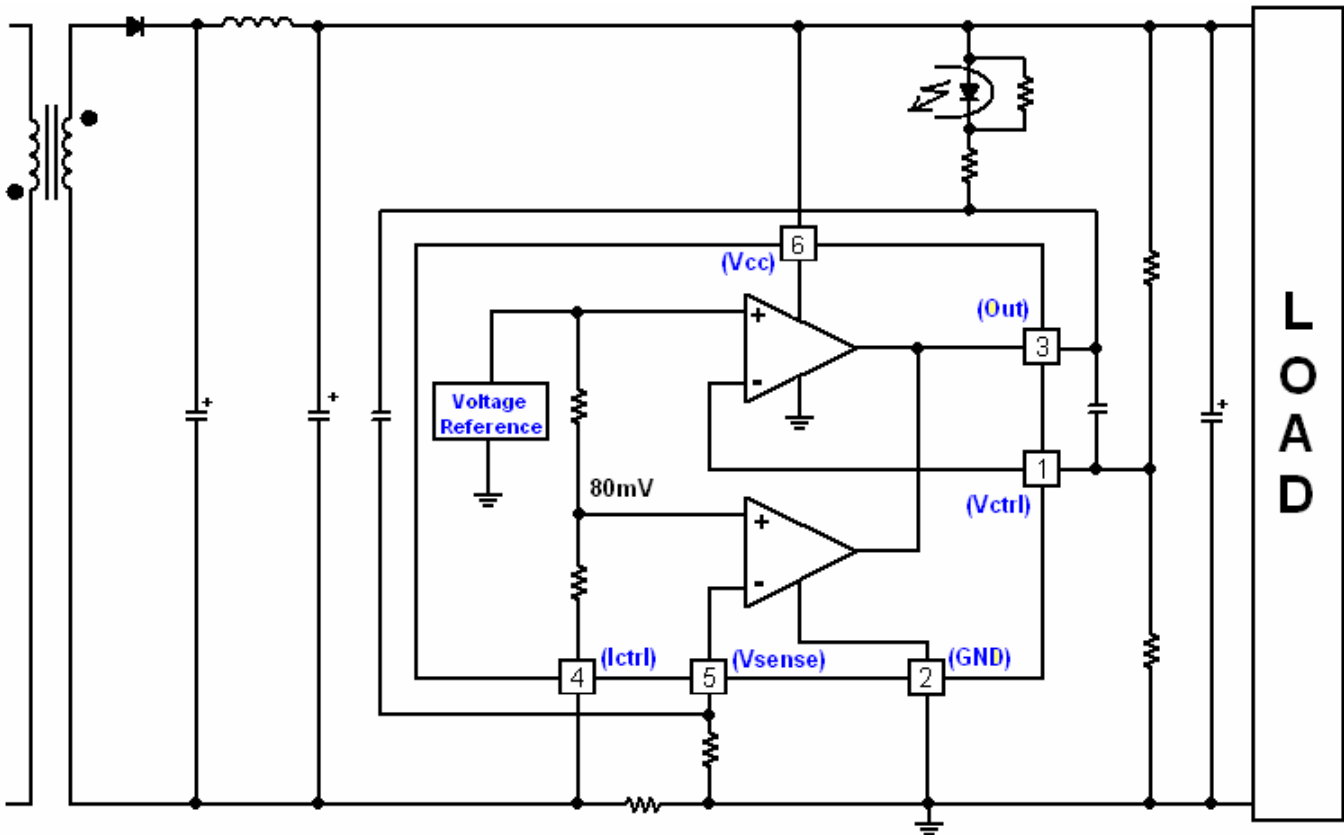

In the above application schematic, the SL71053 is used on the secondary side of a flyback adapter (or battery charger) to provide an accurate control of voltage and current. The above feedback loop is made with an optocoupler.

Pin Description

Name	Pin No.	Type	Function
Vctrl	1	Analog Input	Input Pin of the Voltage Control Loop
Gnd	2	Power Supply	Ground Line. 0V Reference For All Voltages
Out	3	Current Sink Output	Output Pin. Sinking Current Only
Ictrl	4	Analog Input	Input Pin of the Current Control Loop
Vsense	5	Analog Input	Input Pin of the Current Control Loop
V _{CC}	6	Power Supply	DC Supply Line

Absolute Maximum Ratings

Characteristic	Symbol	Value	Unit
DC Supply Voltage	V _{CC}	14	V
Power Dissipation	P _d *	500	mW
Operating Ambient Temperature Range	T _{opr}	0 to 85	°C
Storage Temperature Range	T _{stg}	-55 to 150	°C

* Mount on a glass epoxy circuit board of 30x30mm Pad dimension of 50mm²

Operating Conditions

Characteristic	Symbol	Value	Unit
DC Supply Voltage	V _{CC}	2.2 ~ 14V	V

Electrical Characteristics

T_a = 25°C and V_{CC} = 5V (unless otherwise specified)

Characteristic	Symbol	Test Condition	Min.	Typ.	Max.	Unit
[Total Current Consumption]						
Total Supply Current – not taking the output sinking current into account	I _{CC}	T _a = 25°C	-	1.2	2	mA
		0 < T _a < 85°C	-	1.5	-	

Electrical Characteristics

$T_a = 25^\circ\text{C}$ and $V_{CC} = 5\text{V}$ (unless otherwise specified)

Characteristic	Symbol	Test Condition	Min.	Typ.	Max.	Unit
[Voltage Control Loop]						
Transconductance Gain (Vctrl). Sink Current Only ¹⁾	G_{mv}	$T_a = 25^\circ\text{C}$	1	3.5	-	mA/mV
		$0 < T_a < 85^\circ\text{C}$	-	2.5	-	
Voltage Control Loop Reference ²⁾	V_{ref}	$T_a = 25^\circ\text{C}$	1.198	1.210	1.222	V
		$0 < T_a < 85^\circ\text{C}$	1.186	1.210	1.234	
Input Bias Current (Vctrl)	I_{ibv}	$T_a = 25^\circ\text{C}$	-	50	-	nA
		$0 < T_a < 85^\circ\text{C}$	-	100	-	
[Current Control Loop]						
Transconductance Gain (Ictrl). sink Current Only ³⁾	G_{mi}	$T_a = 25^\circ\text{C}$	1.5	7.0	-	mA/mV
		$0 < T_a < 85^\circ\text{C}$	-	-	-	
Current Control Loop Reference ⁴⁾	V_{sense}	$I_{out} = 2.5\text{ mA}, T_a = 25^\circ\text{C}$	77	80	83	mV
		$0 < T_a < 85^\circ\text{C}$	75	-	85	
Current out of pin ICTRL at -200mV	I_{ibi}	$T_a = 25^\circ\text{C}$	-	25	-	μA
		$0 < T_a < 85^\circ\text{C}$	-	30	-	
[Output Stage]						
Low output Voltage at 10mA Sinking current	V_{ol}	-	-	200	-	mV
Output Short Circuit Current. Output to V_{CC} . Sink Current Only	I_{os}	-	-	35	70	mA

- 1) If the voltage on VCTRL (the negative input of the amplifier) is higher than the positive amplifier input ($V_{ref} = 1.210\text{V}$), and it is increased by 1mV, the sinking current at the output OUT will be increased by 3.5mA.
- 2) The internal voltage reference is set at 1.210V (bandgap reference). The voltage control loop precision takes into account the cumulative effects of the internal voltage reference deviation as well as the input offset voltage of the trans-conductance operational amplifier. The internal voltage reference is fixed by bandgap, and trimmed to 0.5% accuracy at room temperature.
- 3) When the positive input at ICTRL is lower than -80mV, and the voltage is decreased by 1mV, the sinking current at the output OUT will be increased by 7mA.
- 4) The internal current sense threshold is set to -80mV. The current control loop precision takes into account the cumulative effects of the internal voltage reference deviation as well as the input offset voltage of the trans-conduction operational amplifier.

Electrical Characteristic Curves

Fig.1 Supply current vs Ambient Temperature

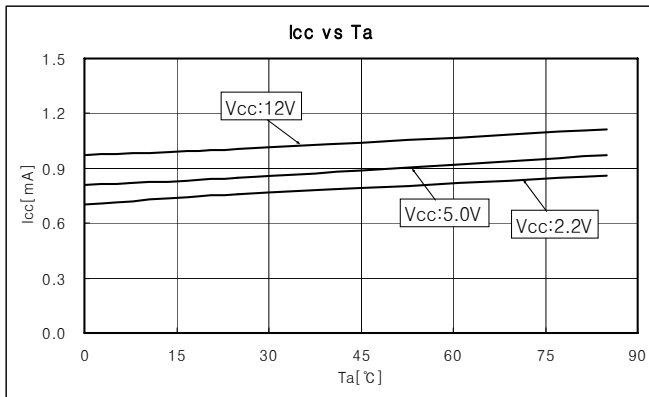

Fig.2 Vref vs Ambient Temperature

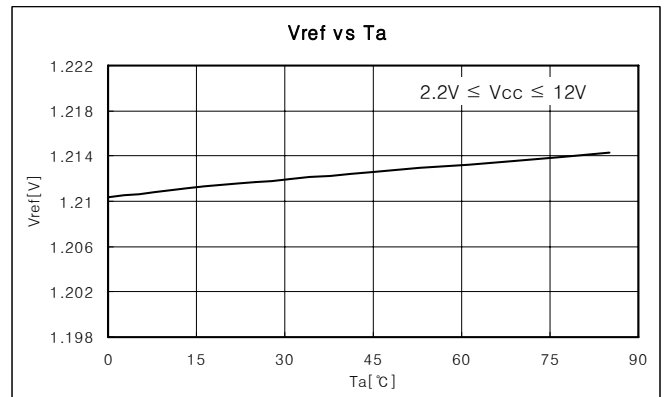

Fig.3 Vsense vs Ambient Temperature

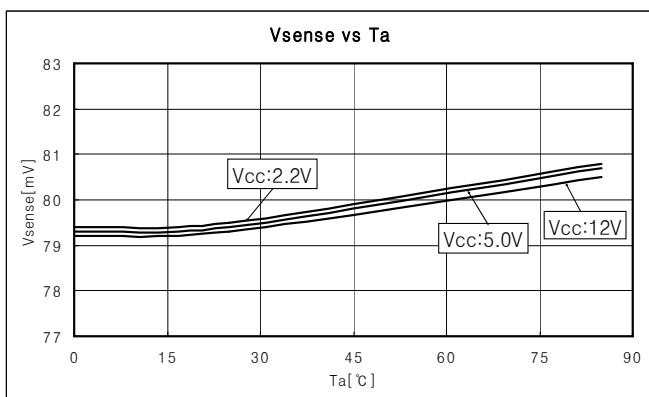

Fig.4 Vsense pin input bias current vs Ambient Temperature

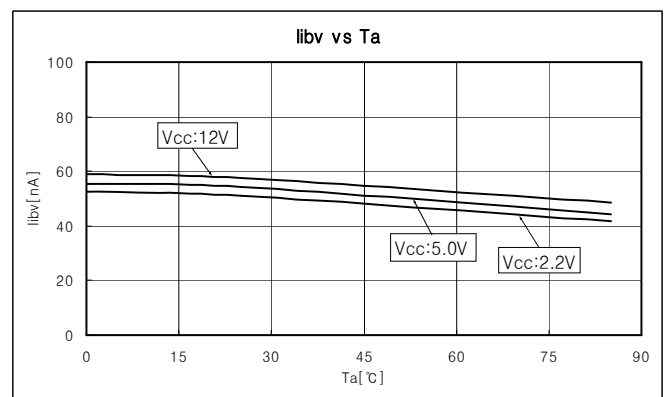

Fig.5 Ictrl pin input bias current vs Ambient Temperature

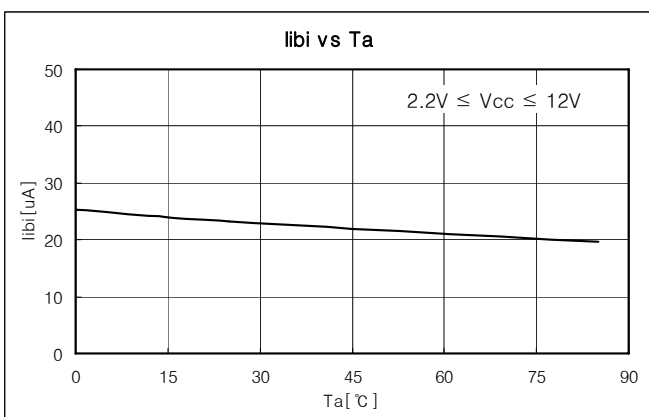
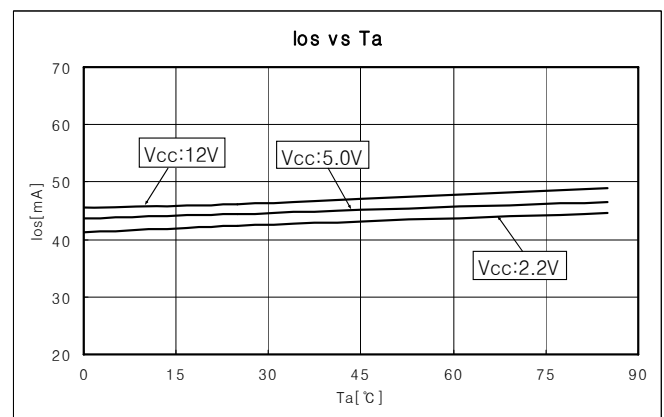

Fig.6 Output Short circuit current vs Ambient Temperature



The AUK Corp. products are intended for the use as components in general electronic equipment (Office and communication equipment, measuring equipment, home appliance, etc.).

Please make sure that you consult with us before you use these AUK Corp. products in equipments which require high quality and / or reliability, and in equipments which could have major impact to the welfare of human life(atomic energy control, airplane, spaceship, transportation, combustion control, all types of safety device, etc.). AUK Corp. cannot accept liability to any damage which may occur in case these AUK Corp. products were used in the mentioned equipments without prior consultation with AUK Corp..

Specifications mentioned in this publication are subject to change without notice.