

Cool MOS™ Power Transistor

Feature

- New revolutionary high voltage technology
- Ultra low gate charge
- Periodic avalanche rated
- Extreme dv/dt rated
- High peak current capability
- Improved transconductance
- Pb-free lead plating; RoHS compliant
- Qualified according to JEDEC⁰⁾ for target applications

$V_{DS} @ T_{jmax}$	650	V
$R_{DS(on)}$	0.95	Ω
I_D	4.5	A

PG-TO251

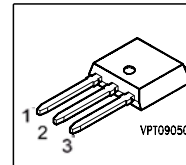

PG-TO252

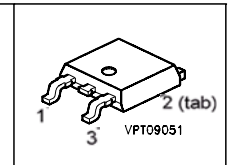

Type	Package	Ordering Code	Marking
SPD04N60C3	PG-TO252	Q67040-S4412	04N60C3
SPU04N60C3	PG-TO251		04N60C3

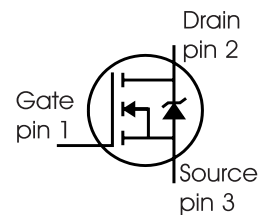

Maximum Ratings

Parameter	Symbol	Value	Unit
Continuous drain current $T_C = 25\text{ }^\circ\text{C}$ $T_C = 100\text{ }^\circ\text{C}$	I_D	4.5 2.8	A
Pulsed drain current, t_p limited by T_{jmax}	$I_{D\text{ puls}}$	13.5	
Avalanche energy, single pulse $I_D = 3.4\text{ A}$, $V_{DD} = 50\text{ V}$	E_{AS}	130	mJ
Avalanche energy, repetitive t_{AR} limited by T_{jmax} ¹ $I_D = 4.5\text{ A}$, $V_{DD} = 50\text{ V}$	E_{AR}	0.4	
Avalanche current, repetitive t_{AR} limited by T_{jmax}	I_{AR}	4.5	A
Gate source voltage static	V_{GS}	± 20	V
Gate source voltage AC ($f > 1\text{ Hz}$)	V_{GS}	± 30	
Power dissipation, $T_C = 25\text{ }^\circ\text{C}$	P_{tot}	50	W
Operating and storage temperature	T_j, T_{stg}	-55... +150	$^\circ\text{C}$
Reverse diode dv/dt ⁵⁾	dv/dt	15	V/ns

Maximum Ratings

Parameter	Symbol	Value	Unit
Drain Source voltage slope $V_{DS} = 480 \text{ V}, I_D = 4.5 \text{ A}, T_j = 125 \text{ }^\circ\text{C}$	dv/dt	50	V/ns

Thermal Characteristics

Parameter	Symbol	Values			Unit
		min.	typ.	max.	
Thermal resistance, junction - case	R_{thJC}	-	-	2.5	K/W
Thermal resistance, junction - ambient, leaded	R_{thJA}	-	-	75	
SMD version, device on PCB: @ min. footprint @ 6 cm ² cooling area ²⁾	R_{thJA}	-	-	75 50	
Soldering temperature, *) 1.6 mm (0.063 in.) from case for 10s	T_{sold}	-	-	260	°C

Electrical Characteristics, at $T_j=25^\circ\text{C}$ unless otherwise specified

Parameter	Symbol	Conditions	Values			Unit
			min.	typ.	max.	
Drain-source breakdown voltage	$V_{(BR)DSS}$	$V_{GS}=0\text{V}, I_D=0.25\text{mA}$	600	-	-	V
Drain-Source avalanche breakdown voltage	$V_{(BR)DS}$	$V_{GS}=0\text{V}, I_D=4.5\text{A}$	-	700	-	
Gate threshold voltage	$V_{GS(th)}$	$I_D=200\mu\text{A}, V_{GS}=V_{DS}$	2.1	3	3.9	
Zero gate voltage drain current	I_{DSS}	$V_{DS}=600\text{V}, V_{GS}=0\text{V},$ $T_j=25^\circ\text{C},$ $T_j=150^\circ\text{C}$	-	0.5	1 50	μA
Gate-source leakage current	I_{GSS}	$V_{GS}=30\text{V}, V_{DS}=0\text{V}$	-	-	100	
Drain-source on-state resistance	$R_{DS(on)}$	$V_{GS}=10\text{V}, I_D=2.8\text{A},$ $T_j=25^\circ\text{C}$ $T_j=150^\circ\text{C}$	-	0.85	0.95 -	Ω
Gate input resistance	R_G	$f=1\text{MHz}, \text{open Drain}$	-	0.95	-	

*) TO252: reflow soldering, MSL3; TO251: wavesoldering

Electrical Characteristics , at $T_j = 25\text{ }^\circ\text{C}$, unless otherwise specified

Parameter	Symbol	Conditions	Values			Unit
			min.	typ.	max.	
Transconductance	g_{fs}	$V_{DS} \geq 2 \cdot I_D \cdot R_{DS(on)max}$, $I_D = 2.8\text{A}$	-	4.4	-	S
Input capacitance	C_{iss}	$V_{GS} = 0\text{V}$, $V_{DS} = 25\text{V}$, $f = 1\text{MHz}$	-	490	-	pF
Output capacitance	C_{oss}		-	160	-	
Reverse transfer capacitance	C_{rss}		-	15	-	
Effective output capacitance, ³⁾ energy related	$C_{o(er)}$	$V_{GS} = 0\text{V}$, $V_{DS} = 0\text{V to } 480\text{V}$	-	20	-	pF
Effective output capacitance, ⁴⁾ time related	$C_{o(tr)}$		-	35	-	
Turn-on delay time	$t_{d(on)}$	$V_{DD} = 380\text{V}$, $V_{GS} = 0/10\text{V}$, $I_D = 4.5\text{A}$, $R_G = 18\Omega$	-	6	-	ns
Rise time	t_r		-	2.5	-	
Turn-off delay time	$t_{d(off)}$		-	58.5	80	
Fall time	t_f		-	9.5	14	

Gate Charge Characteristics

Gate to source charge	Q_{gs}	$V_{DD} = 480\text{V}$, $I_D = 4.5\text{A}$	-	2.2	-	nC
Gate to drain charge	Q_{gd}		-	8.8	-	
Gate charge total	Q_g	$V_{DD} = 480\text{V}$, $I_D = 4.5\text{A}$, $V_{GS} = 0\text{ to } 10\text{V}$	-	19	25	
Gate plateau voltage	$V_{(plateau)}$	$V_{DD} = 480\text{V}$, $I_D = 4.5\text{A}$	-	5	-	V

⁰J-STD20 and JESD22

¹Repetitive avalanche causes additional power losses that can be calculated as $P_{AV} = E_{AR} \cdot f$.

²Device on 40mm*40mm*1.5mm epoxy PCB FR4 with 6cm² (one layer, 70 μm thick) copper area for drain connection. PCB is vertical without blown air.

³ $C_{o(er)}$ is a fixed capacitance that gives the same stored energy as C_{oss} while V_{DS} is rising from 0 to 80% V_{DSS} .

⁴ $C_{o(tr)}$ is a fixed capacitance that gives the same charging time as C_{oss} while V_{DS} is rising from 0 to 80% V_{DSS} .

⁵ $I_{SD} \leq I_D$, $di/dt \leq 400\text{A/us}$, $V_{DClink} = 400\text{V}$, $V_{peak} < V_{BR, DSS}$, $T_j < T_{j,max}$.

Identical low-side and high-side switch.

Electrical Characteristics, at $T_j = 25\text{ }^\circ\text{C}$, unless otherwise specified

Parameter	Symbol	Conditions	Values			Unit
			min.	typ.	max.	
Inverse diode continuous forward current	I_S	$T_C=25^\circ\text{C}$	-	-	4.5	A
Inverse diode direct current, pulsed	I_{SM}		-	-	13.5	
Inverse diode forward voltage	V_{SD}	$V_{GS}=0\text{V}, I_F=I_S$	-	1	1.2	V
Reverse recovery time	t_{rr}	$V_R=480\text{V}, I_F=I_S,$	-	300	500	ns
Reverse recovery charge	Q_{rr}	$di_F/dt=100\text{A}/\mu\text{s}$	-	2.6	-	μC
Peak reverse recovery current	I_{rrm}		-	18	-	A
Peak rate of fall of reverse recovery current	di_{rr}/dt		-	-	900	$\text{A}/\mu\text{s}$

Typical Transient Thermal Characteristics

Symbol	Value	Unit	Symbol	Value	Unit
	typ.			typ.	
Thermal resistance			Thermal capacitance		
R_{th1}	0.039	K/W	C_{th1}	0.00007347	Ws/K
R_{th2}	0.074		C_{th2}	0.0002831	
R_{th3}	0.132		C_{th3}	0.0004062	
R_{th4}	0.555		C_{th4}	0.001215	
R_{th5}	0.529		C_{th5}	0.00276	
R_{th6}	0.169		C_{th6}	0.029	

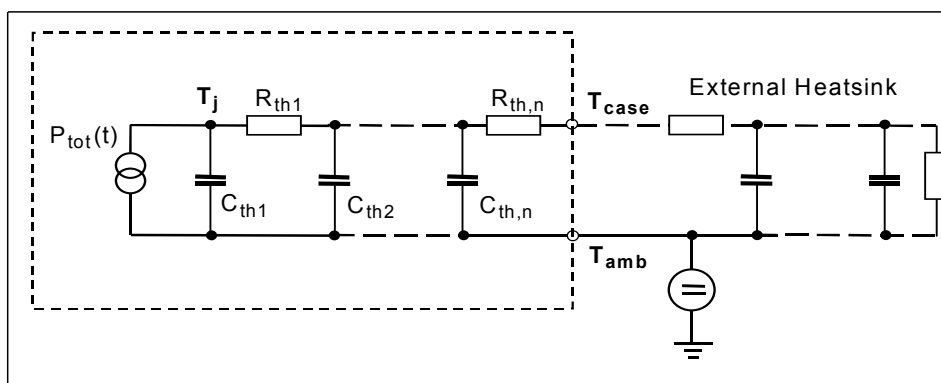

1 Power dissipation

$P_{tot} = f(T_C)$

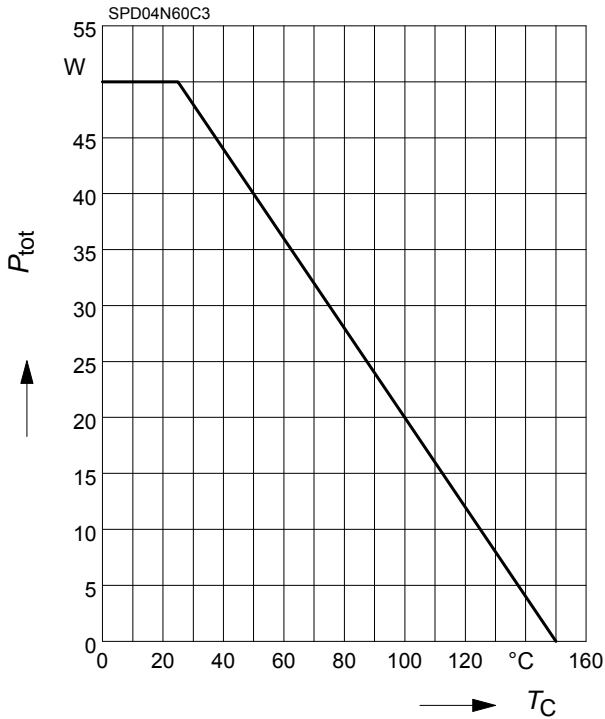

2 Safe operating area

$I_D = f(V_{DS})$

parameter : $D = 0$, $T_C = 25^\circ C$

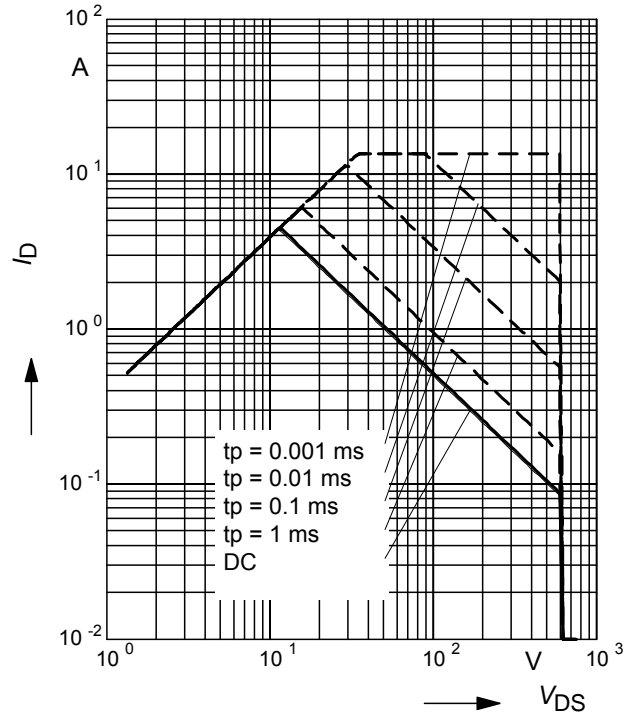

3 Transient thermal impedance

$Z_{thJC} = f(t_p)$

parameter: $D = t_p/T$

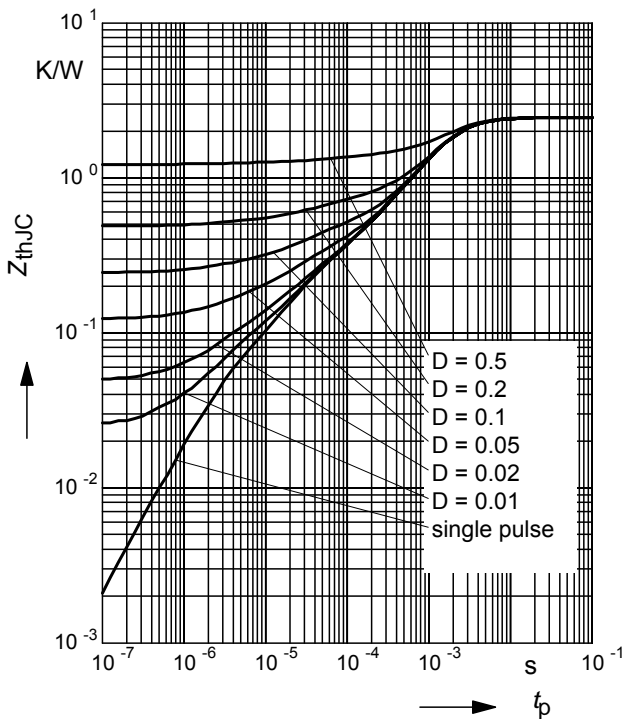

4 Typ. output characteristic

$I_D = f(V_{DS})$; $T_j = 25^\circ C$

parameter: $t_p = 10 \mu s$, V_{GS}

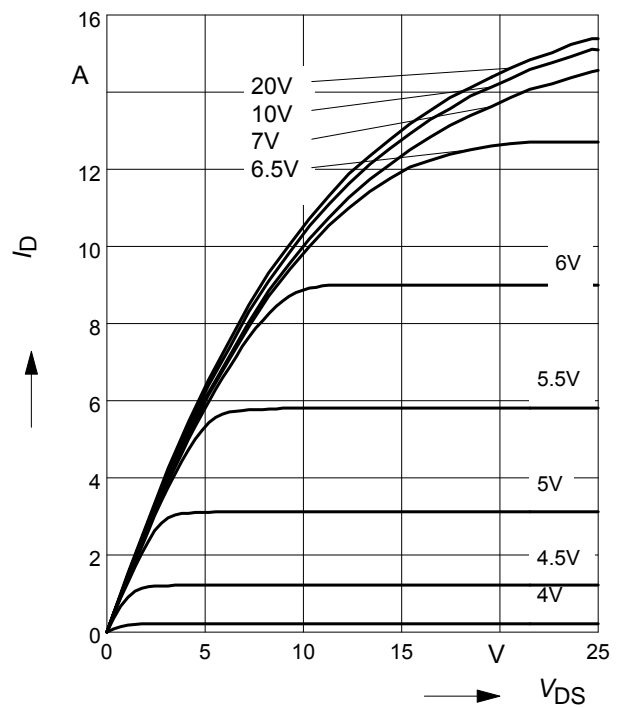

5 Typ. output characteristic

$I_D = f(V_{DS}); T_j = 150^\circ\text{C}$

parameter: $t_p = 10 \mu\text{s}, V_{GS}$

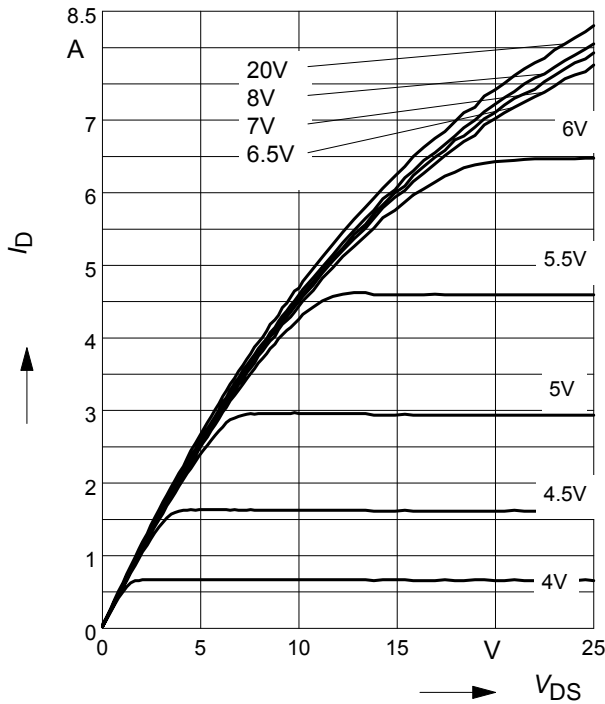

6 Typ. drain-source on resistance

$R_{DS(on)} = f(I_D)$

parameter: $T_j = 150^\circ\text{C}, V_{GS}$

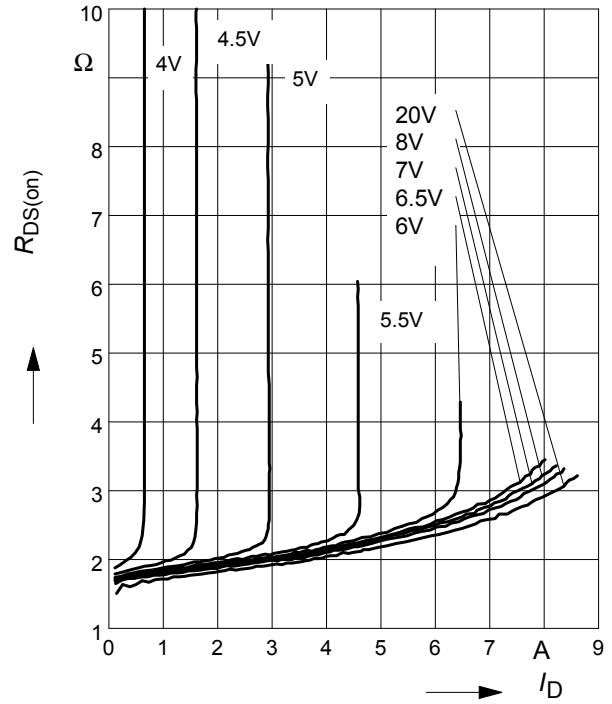

7 Drain-source on-state resistance

$R_{DS(on)} = f(T_j)$

parameter: $I_D = 2.8 \text{ A}, V_{GS} = 10 \text{ V}$

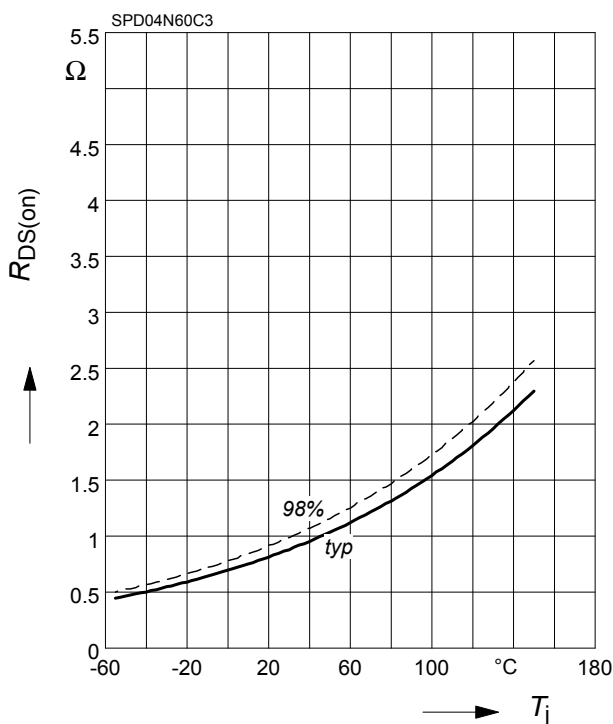

8 Typ. transfer characteristics

$I_D = f(V_{GS}); V_{DS} \geq 2 \times I_D \times R_{DS(on)max}$

parameter: $t_p = 10 \mu\text{s}$

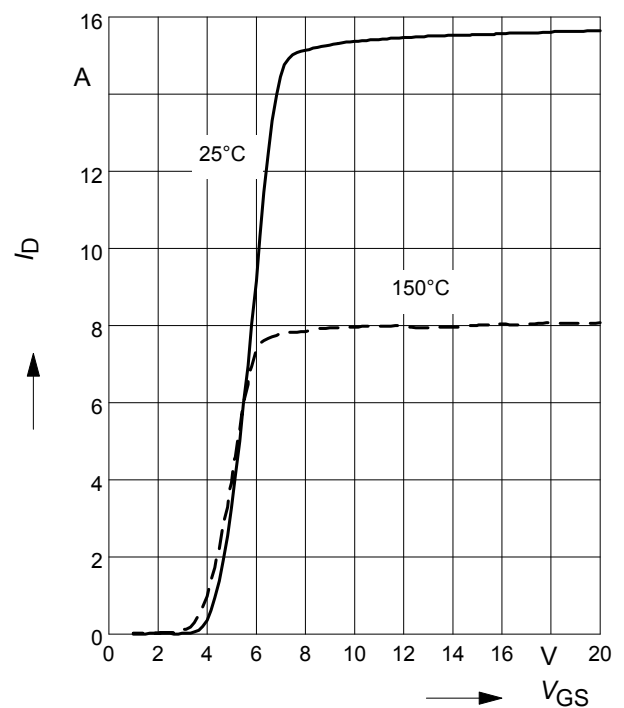

9 Typ. gate charge

$V_{GS} = f(Q_{Gate})$

parameter: $I_D = 4.5$ A pulsed

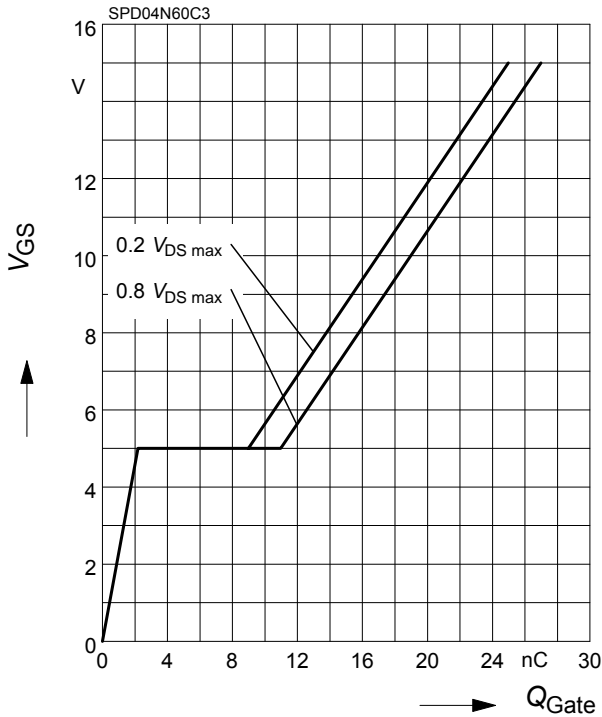

10 Forward characteristics of body diode

$I_F = f(V_{SD})$

parameter: $T_j, t_p = 10 \mu s$

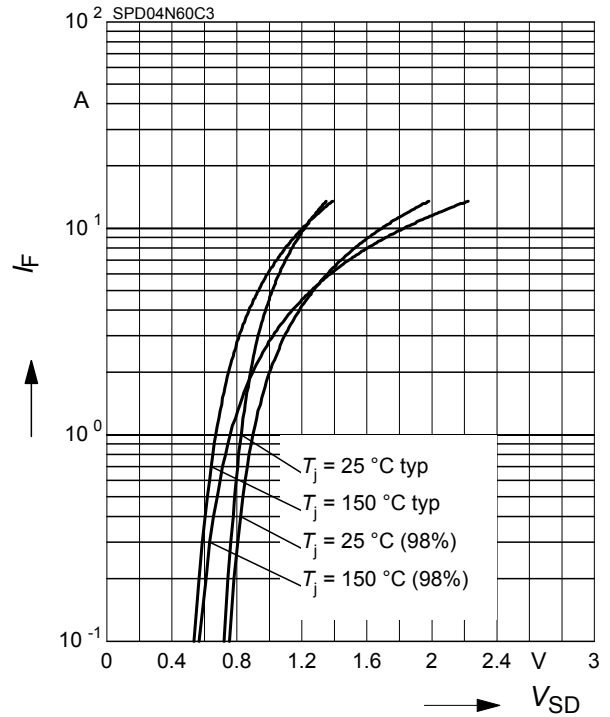

11 Typ. drain current slope

$di/dt = f(R_G)$, inductive load, $T_j = 125^\circ C$

par.: $V_{DS} = 380V, V_{GS} = 0/+13V, I_D = 4.5A$

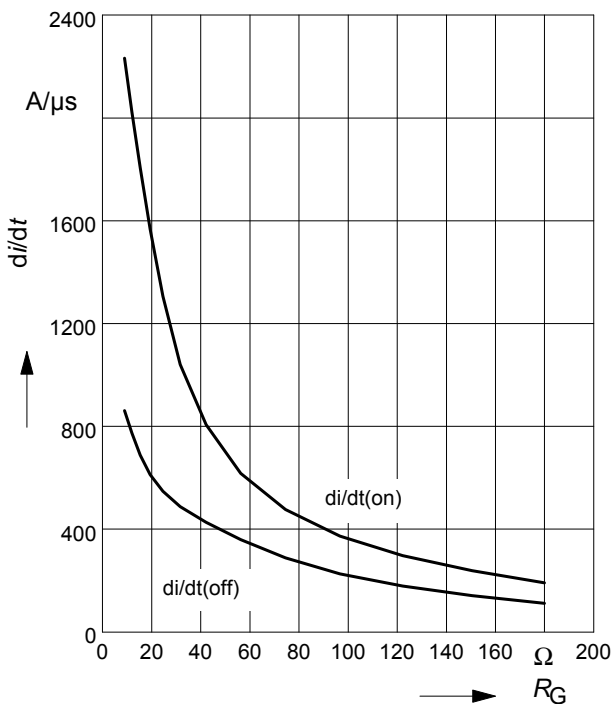

12 Typ. switching time

$t = f(R_G)$, inductive load, $T_j = 125^\circ C$

par.: $V_{DS} = 380V, V_{GS} = 0/+13V, I_D = 4.5$ A

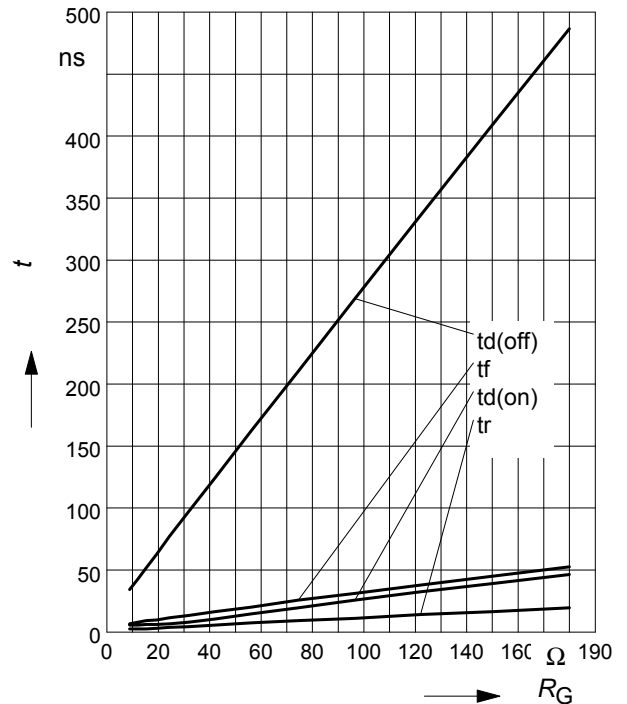

13 Typ. switching time

$t = f(I_D)$, inductive load, $T_j=125^\circ\text{C}$
par.: $V_{DS}=380\text{V}$, $V_{GS}=0/+13\text{V}$, $R_G=18\Omega$

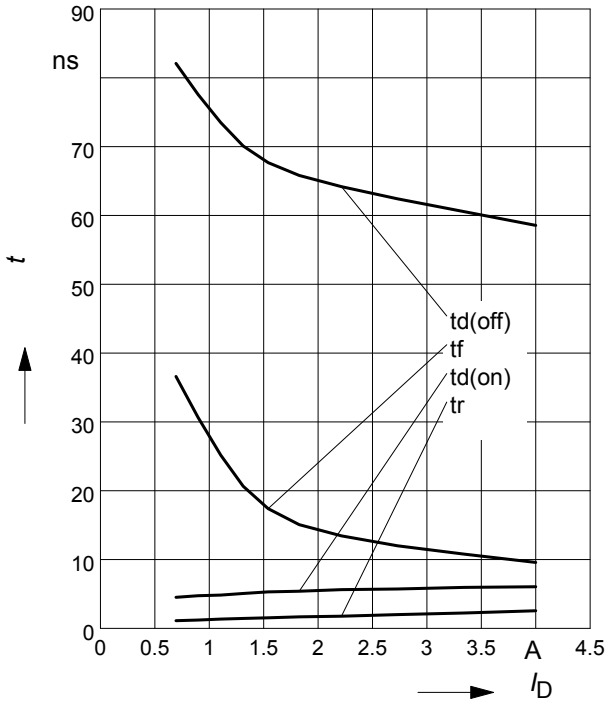

14 Typ. drain source voltage slope

$dv/dt = f(R_G)$, inductive load, $T_j = 125^\circ\text{C}$
par.: $V_{DS}=380\text{V}$, $V_{GS}=0/+13\text{V}$, $I_D=4.5\text{A}$

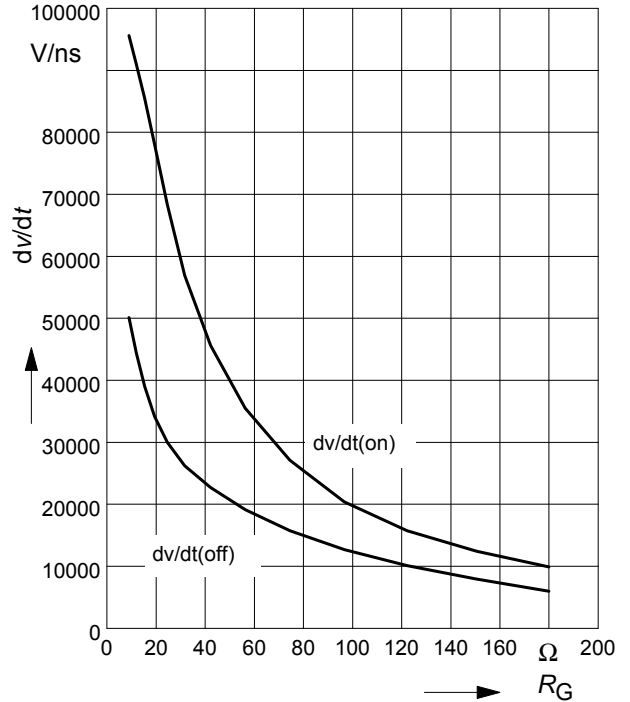

15 Typ. switching losses

$E = f(I_D)$, inductive load, $T_j=125^\circ\text{C}$
par.: $V_{DS}=380\text{V}$, $V_{GS}=0/+13\text{V}$, $R_G=18\Omega$

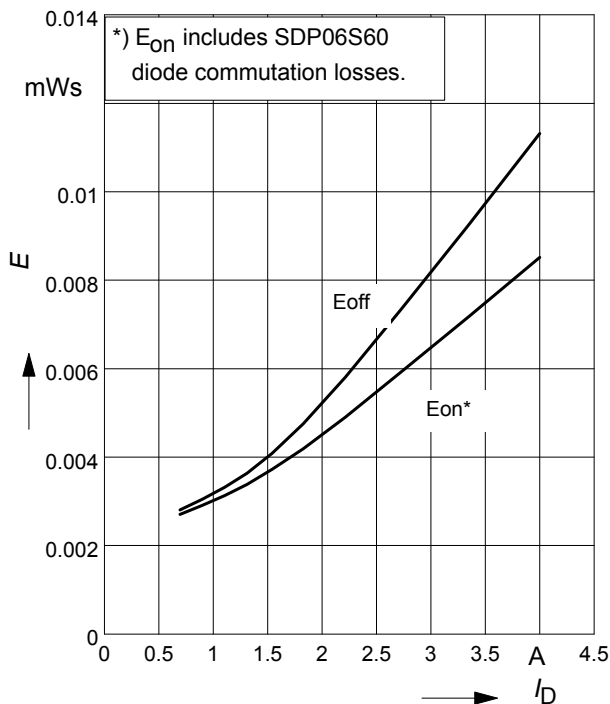

16 Typ. switching losses

$E = f(R_G)$, inductive load, $T_j=125^\circ\text{C}$
par.: $V_{DS}=380\text{V}$, $V_{GS}=0/+13\text{V}$, $I_D=4.5\text{A}$

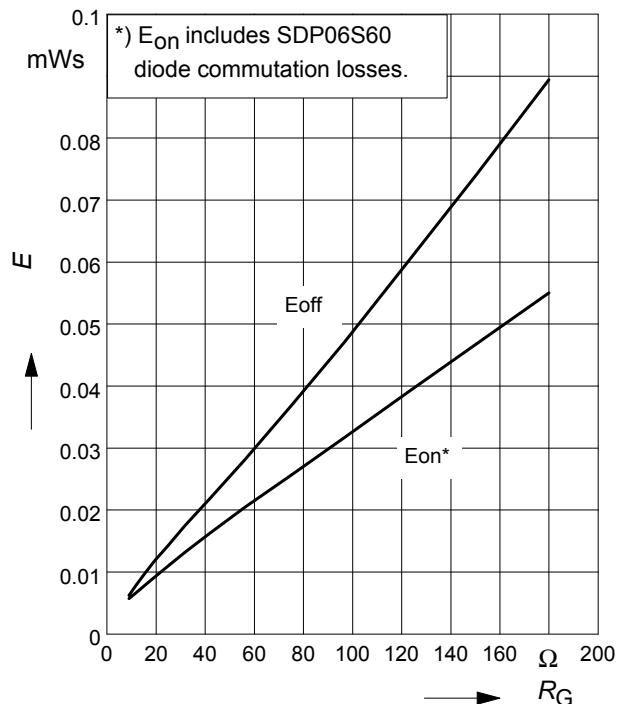

17 Avalanche SOA

$$I_{AR} = f(t_{AR})$$

par.: $T_j \leq 150\text{ }^\circ\text{C}$

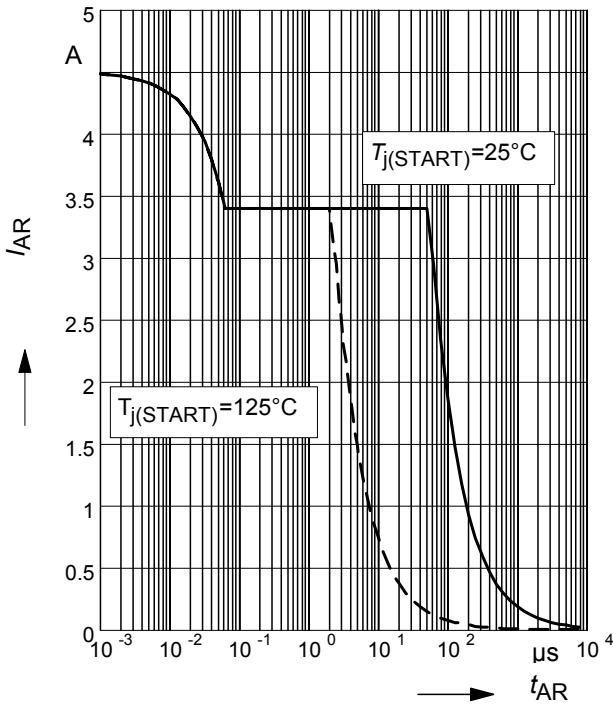

18 Avalanche energy

$$E_{AS} = f(T_j)$$

par.: $I_D = 3.4\text{ A}$, $V_{DD} = 50\text{ V}$

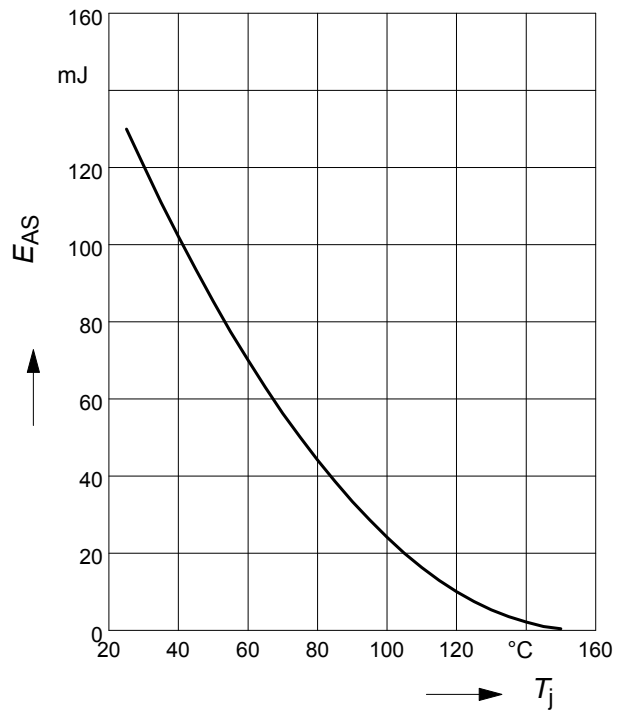

19 Drain-source breakdown voltage

$$V_{(BR)DSS} = f(T_j)$$

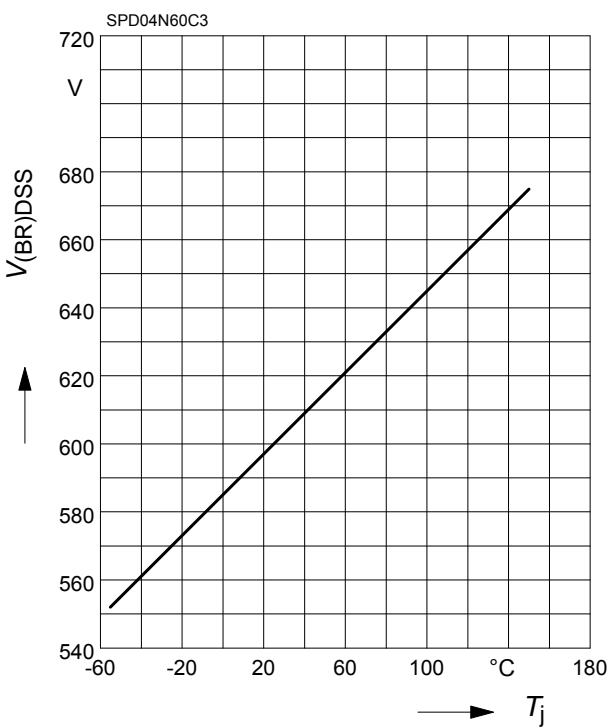

20 Avalanche power losses

$$P_{AR} = f(f)$$

parameter: $E_{AR} = 0.4\text{ mJ}$

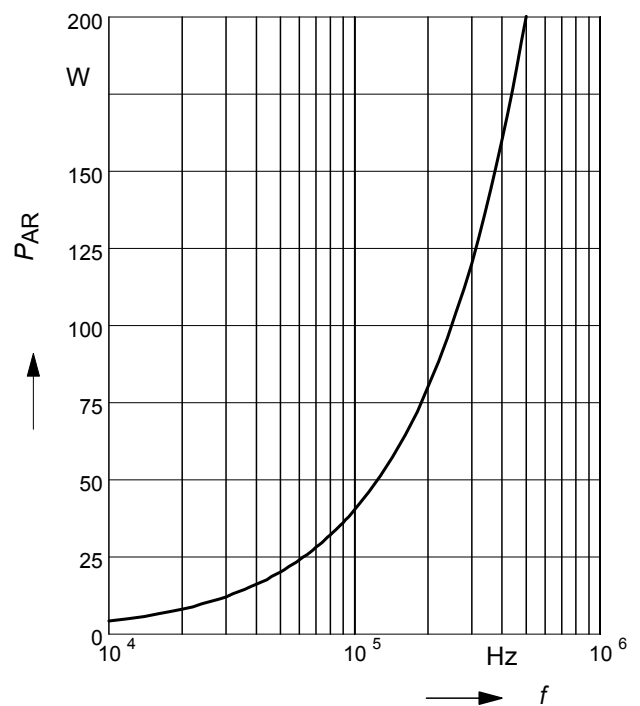

21 Typ. capacitances

$C = f(V_{DS})$

parameter: $V_{GS}=0V, f=1\text{ MHz}$

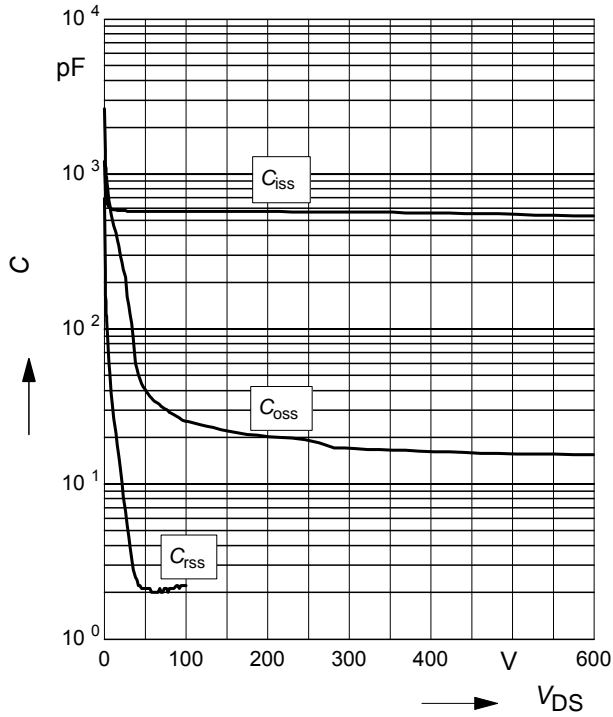

22 Typ. C_{oss} stored energy

$E_{oss}=f(V_{DS})$

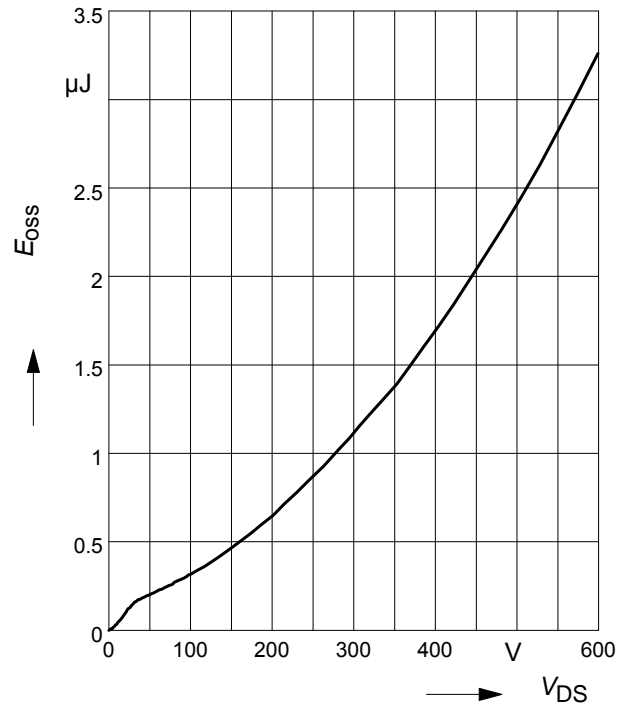

Definition of diodes switching characteristics

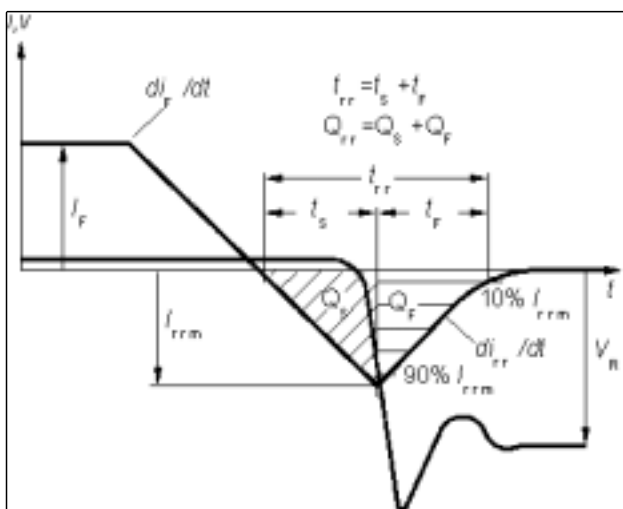

PG-TO-252-3-1 (D-PAK), PG-TO-252-3-11 (D-PAK), PG-TO-252-3-21 (D-PAK)

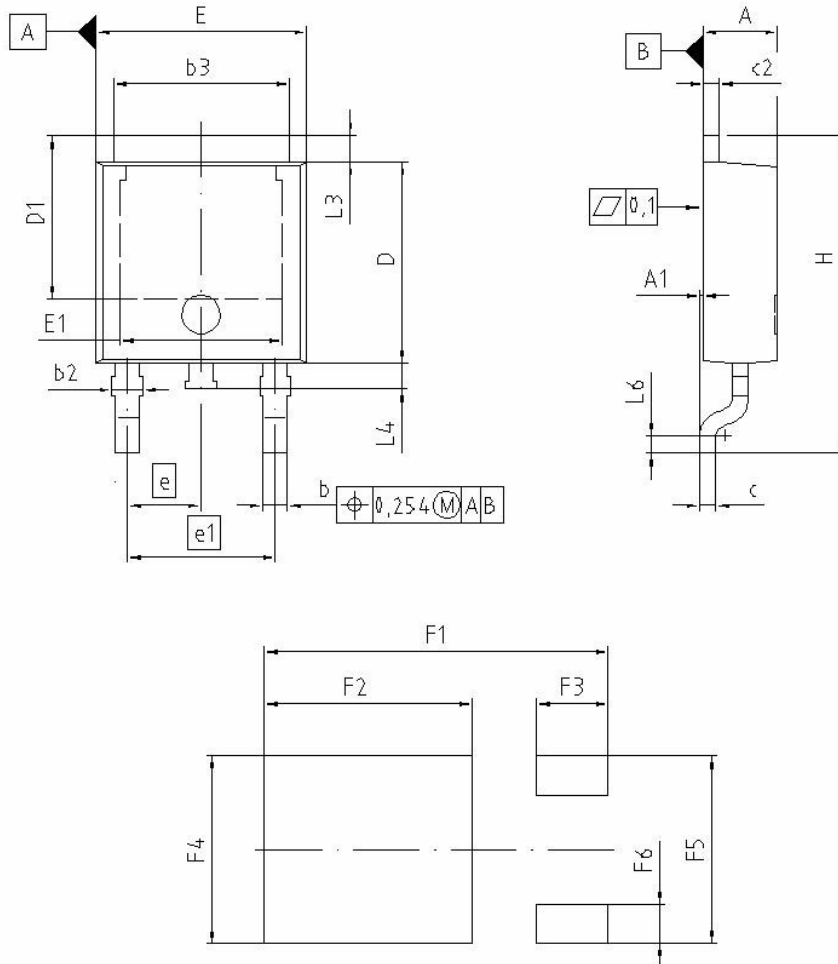

DIM	MILLIMETERS		INCHES	
	MIN	MAX	MIN	MAX
A	2.159	2.413	0.085	0.095
A1	0.000	0.150	0.000	0.006
b	0.635	0.889	0.025	0.035
b2	0.650	1.150	0.026	0.045
b3	5.004	5.500	0.197	0.217
c	0.457	0.580	0.018	0.023
c2	0.460	0.980	0.018	0.039
D	5.969	6.223	0.235	0.245
D1	5.020	5.842	0.198	0.230
E	6.400	6.731	0.252	0.265
E1	4.850	5.207	0.191	0.205
e	2.286		0.090	
e1	4.572		0.180	
N	3		3	
H	9.400	10.480	0.370	0.413
L3	0.900	1.143	0.035	0.045
L4	0.584	0.950	0.023	0.037
L6	0.510	0.686	0.020	0.027
F1	10.500	10.700	0.413	0.421
F2	6.300	6.500	0.248	0.256
F3	2.100	2.300	0.083	0.091
F4	5.700	5.900	0.224	0.232
F5	5.660	5.860	0.222	0.231
F6	1.100	1.300	0.043	0.051

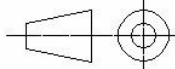
REFERENCE JEDEC TO252
SCALE 0 2.0 4mm
EUROPEAN PROJECTION 
ISSUE DATE 21-09-2005
FILE TO252_1

PG-TO-251-3-1 (I-PAK), PG-TO-251-3-21 (I-PAK)

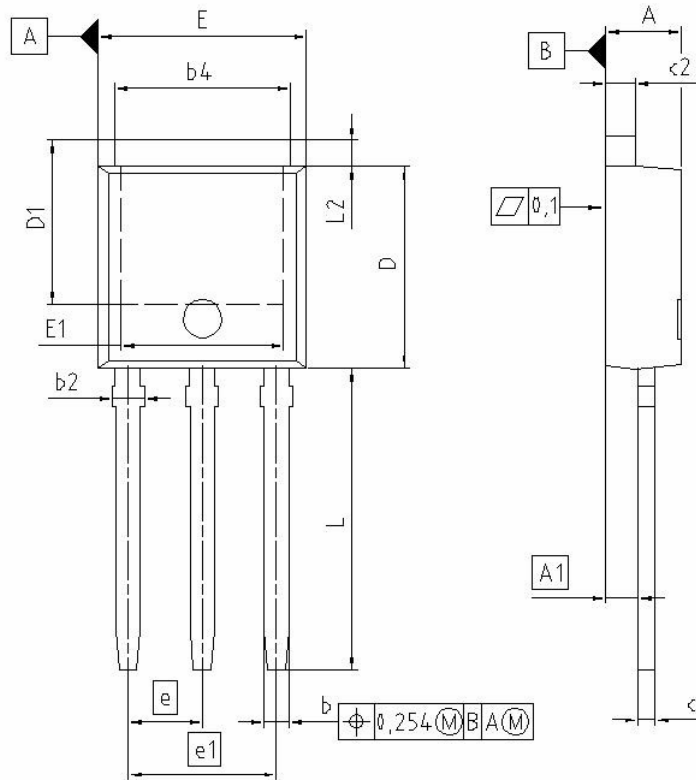

DIM	MILLIMETERS		INCHES	
	MIN	MAX	MIN	MAX
A	2.159	2.413	0.085	0.095
A1	0.900	1.118	0.035	0.044
b	0.650	0.850	0.026	0.033
b2	0.650	1.150	0.026	0.045
b4	5.004	5.500	0.197	0.217
c	0.457	0.580	0.018	0.023
c2	0.737	0.980	0.029	0.039
D	5.969	6.223	0.235	0.245
D1	5.100	6.121	0.201	0.241
E	6.400	6.731	0.252	0.265
E1	4.850	5.207	0.191	0.205
e	2.280		0.090	
e1	4.570		0.180	
N	3		3	
L	8.900	9.525	0.350	0.375
L1	0.900	1.143	0.035	0.045

REFERENCE
JEDEC TO251

SCALE

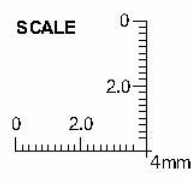

EUROPEAN PROJECTION

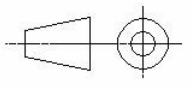

ISSUE DATE
20-07-2005

FILE
TO251_1

Published by
Infineon Technologies AG
81726 München
Germany

© Infineon Technologies AG 2006
All Rights Reserved.

Attention please!

The information herein is given to describe certain components and shall not be considered as warranted characteristics.

Terms of delivery and rights to technical change reserved.

We hereby disclaim any and all warranties, including but not limited to warranties of non-infringement, regarding circuits, descriptions and charts stated herein.

Infineon Technologies is an approved CECC manufacturer.

Information

For further information on technology, delivery terms and conditions and prices please contact your nearest Infineon Technologies Office in Germany or our Infineon Technologies Representatives worldwide (see address list).

Warnings

Due to technical requirements components may contain dangerous substances.

For information on the types in question please contact your nearest Infineon Technologies Office.

Infineon Technologies Components may only be used in life-support devices or systems with the express written approval of Infineon Technologies, if a failure of such components can reasonably be expected to cause the failure of that life-support device or system, or to affect the safety or effectiveness of that device or system. Life support devices or systems are intended to be implanted in the human body, or to support and/or maintain and sustain and/or protect human life. If they fail, it is reasonable to assume that the health of the user or other persons may be endangered.