

5W LED Lump Module Design with FT831B

(Preliminary Release)



Index

1	INTRODUCTION	3
2	MODULE SPECIFICATION.....	3
2.1	Input Characteristics	3
2.2	Output Characteristics	3
2.3	Performance Specification	3
2.4	Protection Features	4
2.5	Environmental	4
2.6	Dielectric Withstand (Hi-pot) Test	4
2.7	Insulation	4
3	MODULE INFORMATION	5
3.1	Schematic	5
3.2	PCB Gerber	6
3.3	Bill of Materials	7
3.4	Transformer Design	8
1)	Transformer Specification	8
2)	Electrical diagram	8
3)	Transformer Build Diagram	8
3.5	Module Snapshot	9
4	PERFORMANCE EVALUATION	10
4.1	Input Characteristics	11
1)	Input Normal Characteristics	11
2)	Standby Power	11
4.2	Output Characteristics	11
1)	Precision of Output Current	11
2)	Ripple	11
3)	Time Sequence	12
4.3	Protection	13
1)	Open Circuit Protection	13
2)	Short Circuit Protection	13
4.4	EMI Test	13
5	SYSTEM OTHER IMPORTANT WAVEFORM	15
5.1	MOSFET VDS Wave form at 264Vac, start up/shut down	15
5.2	Output Rectifier Diode VAK Waveform at Full Load	15

1 INTRODUCTION

This document presents performance characteristics of an isolated flyback converter module designed with FT831B. The module features:

- high precision for output current in universal input voltage.
- Simple circuit.

This document contains sessions on power supply specification, schematic/PCB Gerber/BOM, transformer design and performance data.

2 MODULE SPECIFICATION

2.1 Input Characteristics

AC Input Voltage Rating	100Vac to 240Vac
AC Input Voltage Range	90Vac to 264Vac
AC Input Frequency	47Hz to 63Hz

Table 1

2.2 Output Characteristics

Output Voltage	+16.4V
Output Current	350mA
Precision of Output Current	3%
Ripple of Output Voltage	2.3V
Ripple of Output Current	322mA

Table 2

Note: Ripple of Output Voltage is measured with 20MHz bandwidth limited (peak to peak value) at the end of a 12-inch twisted wire terminated with a 10uF capacitor in parallel with a 0.1uF ceramic capacitor.

2.3 Performance Specification

Total Output Power	5.6W Typical
Standby Power	< 0.3W @ 90Vac/63Hz~265Vac/47Hz, no load
Efficiency	77% min. @ 264Vac/50Hz with full load
Turn on Delay Time	≤1.1sec. max. @ 90Vac/50Hz with full load
Switching Frequency	45K Hz ±3%

Table 3

2.4 Protection Features

Short Circuit Protection	Output shut down (Auto Recovery)
Open Circuit Protection	Output Voltage rise to 19V

Table 4

2.5 Environmental

Operating Temperature	-10°C to +40°C
Operating Humidity	20 % to 90 % R. H.
Storage Temperature	-40°C to 85°C
Storage Humidity	0 % to + 90 % R. H.

Table 5

2.6 Dielectric Withstand (Hi-pot) Test

Input to Output	3000Vac 1 min.
-----------------	----------------

Table 6

2.7 Insulation

Input to Output	DC 500V 10M ohm min
-----------------	---------------------

Table 7

3 MODULE INFORMATION

3.1 Schematic

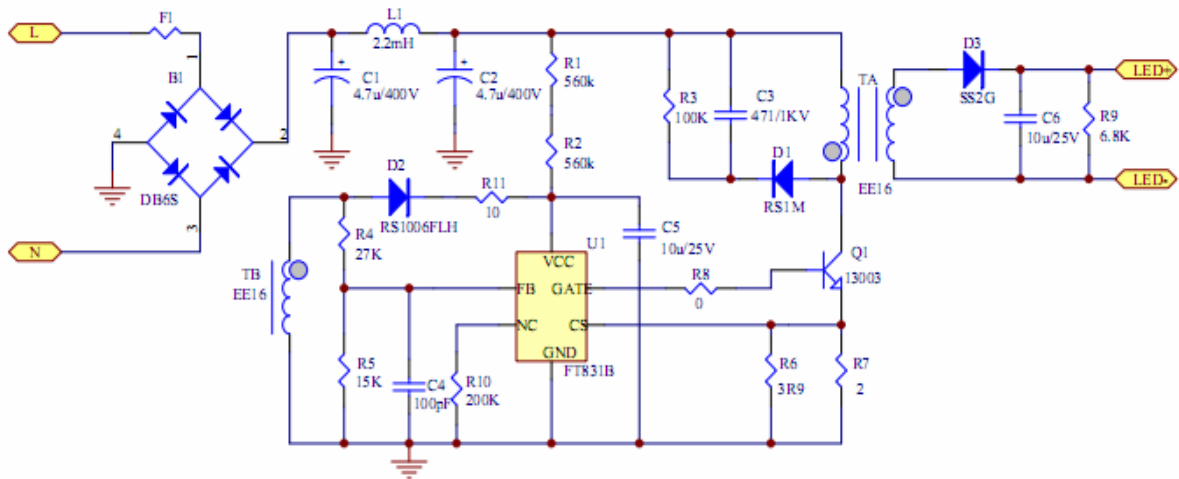

Figure 1: Schematic

3.2 PCB Gerber

Contact us for detail information:

Website: www.fremontmicro.com

E-mail: sales@fremontmicro.com

Tel: (86 755) 86117811 ext 805

Fax: (86 755) 86117810

Figure 2: Top View

Figure 3: Bottom view



3.3 Bill of Materials

Contact us for detail information:

Website: www.fremontmicro.com

E-mail: sales@fremontmicro.com

Tel: (86 755) 86117811 ext 805

Fax: (86 755) 86117810

Table 8

3.4 Transformer Design

- 1) Transformer Specification
- 2) Electrical diagram

Contact us for detail information:

Website: www.fremontmicro.com

E-mail: sales@fremontmicro.com

Tel: (86 755) 86117811 ext 805

Fax: (86 755) 86117810

Figure 4: Electrical Diagram

- 3) Transformer Build Diagram

Figure 5: Transformer Build Diagram

3.5 Module Snapshot

Contact us for detail information:

Website: www.fremontmicro.com

E-mail: sales@fremontmicro.com

Tel: (86 755) 86117811 ext 805

Fax: (86 755) 86117810

Figure 6: Top View

Figure 7: bottom View

4 PERFORMANCE EVALUATION

This session presents the test results of 5W module up to date. Results on inrush current, leakage current and ESD are not included and will be added when they become available.

Overall, the module meets design specifications.

Performance Highlights:

The efficiency over 90Vac ~264Vac is $\geq 77\%$

The standby power is $< 0.3W$ at 264Vac/50Hz with no load

Characterization Results Summary

Test	Specification	Test
1. Input Characteristics		
Input Voltage	90~264V	90~264V
Input Current		$< 0.134A$
Standby power	$< 0.3W$	0.28W
Efficiency (Average)	$> 73\%$	79%
2. Output Characteristics		
Output Voltage Range		15~19V
Output Current Range		330~370mA
Output Voltage Ripple		2.32V
Output Voltage Ripple		0.322A
3. Time Sequence		
Turn on delay time	$< 3.0S$	1.1S
Hold up time		6.8ms
4. Protection		
Open Circuit protection		Pass
Short Circuit protection		Pass

Table 9

4.1 Input Characteristics

1) Input Normal Characteristics

The module was tested at different input voltages (from 90Vac to 264Vac) and different load conditions (full load and no load). Efficiency and standby power were measured and listed in table 10 and table 11.

Input Voltage	I _{rms} (A)	P _{in} (W)	V _o (V)	I _o (A)	η	Specification	Test Result
90V/50Hz	0.134	7.61	16.35	0.361	77.56%	>73%	Pass
115V/50Hz	0.110	7.58	16.46	0.367	79.69%		
230V/50Hz	0.073	7.55	16.35	0.372	80.56%		
264V/50Hz	0.068	7.64	16.47	0.370	79.76%		

Table 10: Input characteristics at full load

2) Standby Power

Input Voltage	V _o (V)	Input Power(W)	Specification	Test Result
90V/50Hz	18.46	0.09	<0.3W	Pass
115V/50Hz	18.54	0.09		
230V/50Hz	18.79	0.21		
264V/50Hz	18.76	0.28		

Table 11: Standby power at no load

4.2 Output Characteristics

1) Precision of Output Current

Input Voltage	90V	115V	230V	264V	Precision
Current	0.361A	0.367A	0.372A	0.370A	±1.5%

Table12: Precision of Output Current

2) Ripple

Input Voltage	90V	115V	230V	264V
Ripple of Output Voltage	2.30V	2.14V	2.16V	2.32V

Table13: Ripple of Output Voltage

Input Voltage	90V	115V	230V	264V
Ripple of Output Current	0.322A	0.300A	0.300A	0.302A

Table14: Ripple of Output Current

Note: Ripple of Output Voltage is measured with 20MHz bandwidth limited (peak to peak value) at the end of a 12-inch twisted wire terminated with a 10uF capacitor in parallel with a 0.1uF ceramic capacitor.

3) Time Sequence

Time sequence parameters were measured with DSO.

Item	Input Voltage	Test Result	Remark
Turn-on Delay	90V/50Hz	1.02S	Figure 8
Hold up Time	90V/50Hz	6.8mS	Figure 9

Table 15: turn-on delay /hold-up time measurement results

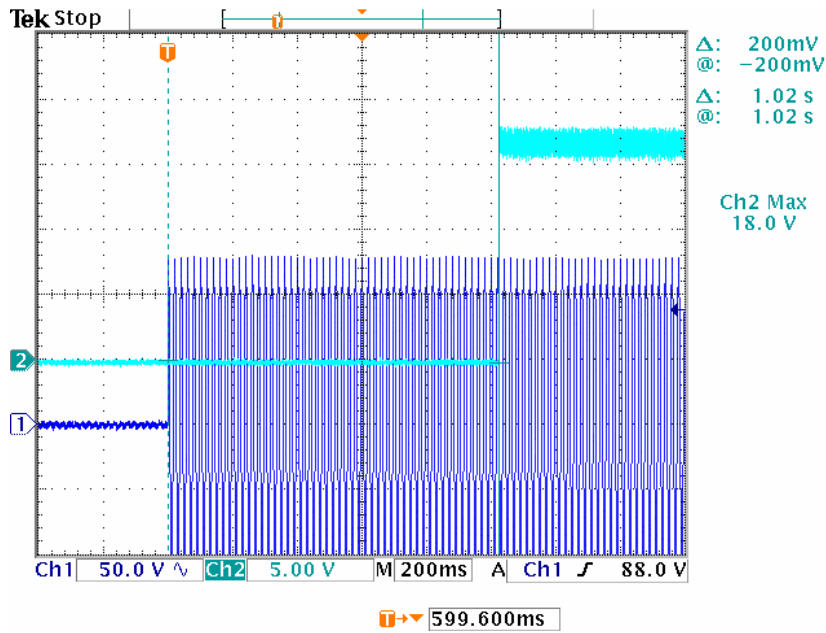

Figure 8: Turn on delay time measured waveform @ 90Vac/50Hz, full load

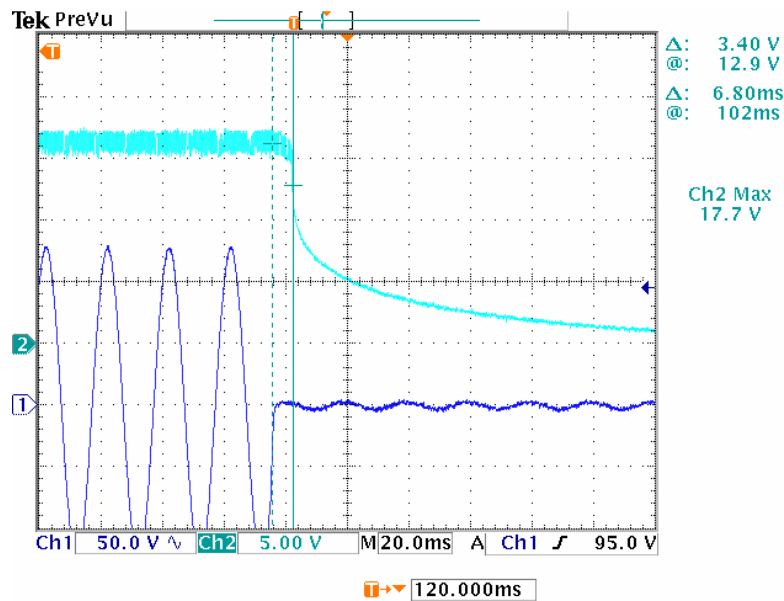

Figure 9: Hold on delay time measured waveform @ 90Vac/50Hz, full load

4.3 Protection

1) Open Circuit Protection

The system is protected during output open circuit condition and recovered when open circuit condition is removed.

2) Short Circuit Protection

The system is protected during output short circuit condition and recovered when short circuit condition is removed.

4.4 EMI Test

The Power supply passed EN55015 Class B EMI requirement with more than 4dB margin.

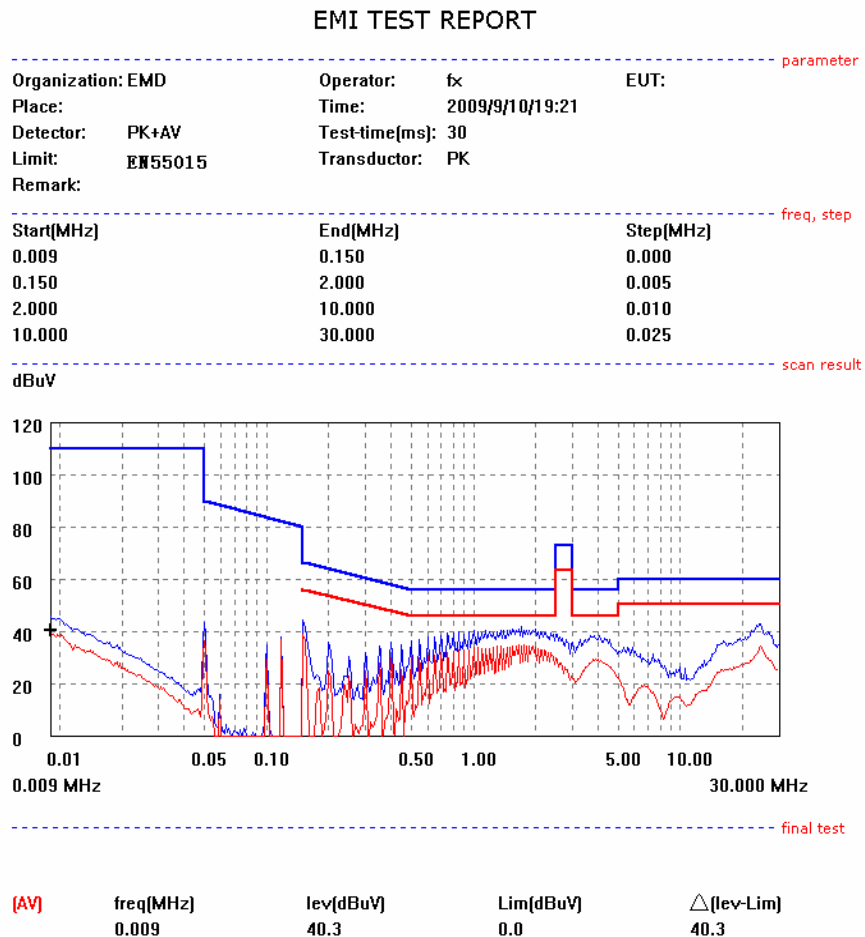

Figure 10: Vin = 120V Full load

EMI TEST REPORT

Organization: EMD	Operator: fx	EUT:	parameter
Place:	Time: 2009/9/10/19:28		
Detector: PK+AV	Test-time(ms): 30		
Limit: EN55015	Transducer: PK		
Remark:			

Start(MHz)	End(MHz)	Step(MHz)	freq, step
0.009	0.150	0.000	
0.150	2.000	0.005	
2.000	10.000	0.010	
10.000	30.000	0.025	

scan result

dBuV

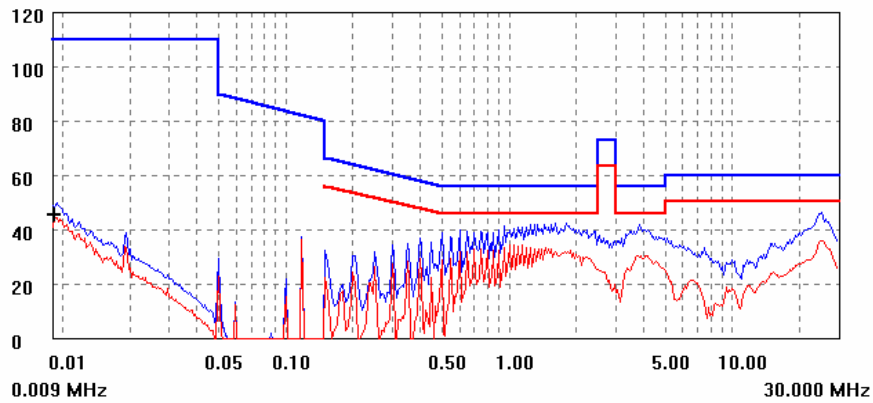

final test

[AV]	freq(MHz)	lev(dBuV)	Lim(dBuV)	Δ (lev-Lim)
	0.009	45.0	0.0	45.0

Figure 11: Vin = 230V Full load

5 SYSTEM OTHER IMPORTANT WAVEFORM

5.1 MOSFET VDS Wave form at 264Vac, start up/shut down

Start up, Vds wave form @ 90Vac/50Hz

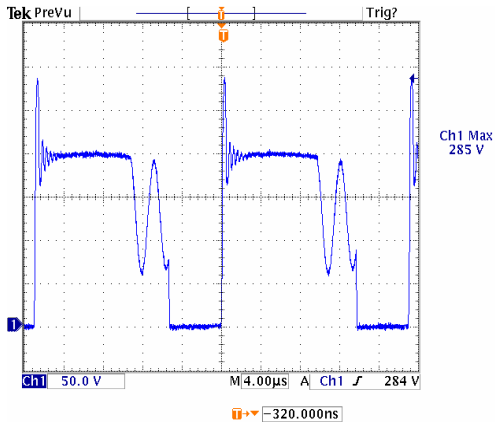

Start up, Vds wave form @ 264 Vac/50Hz

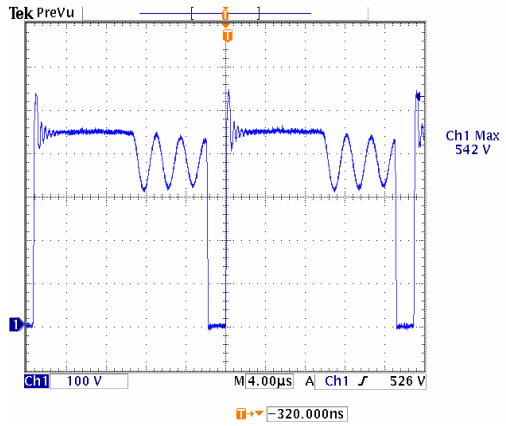

Shut down, Vds wave form @ 90Vac/50Hz

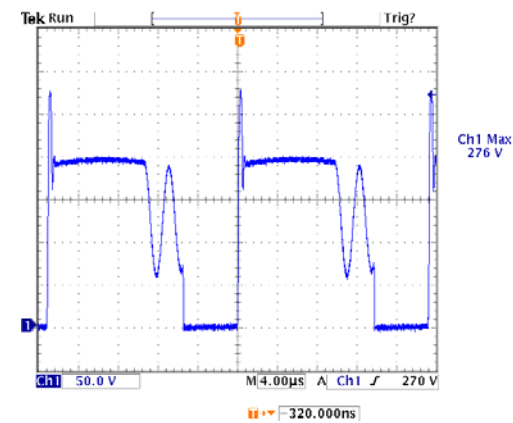

Shut down, Vds wave form @ 264 Vac/50Hz

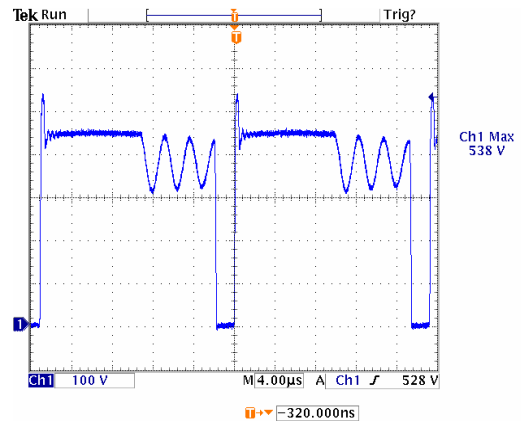

5.2 Output Rectifier Diode VAK Waveform at Full Load

Start up VAK wave form @ 264Vac/50Hz, full load

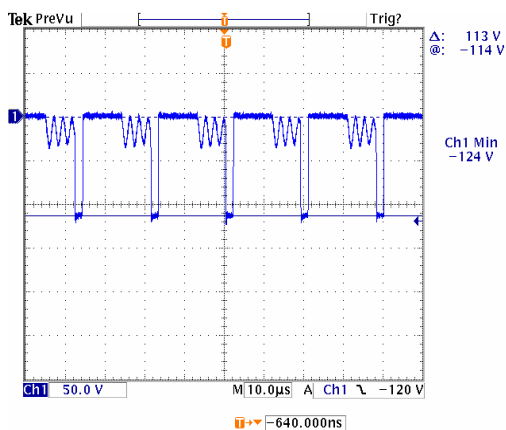

Shut down VAK wave form @ 264Vac/50Hz, full load

