

# LM5116-12 Evaluation Board

National Semiconductor  
Application Note 1713  
Robert Sheehan  
October 2007



## Introduction

The LM5116-12 evaluation board is designed to provide the design engineer with a fully functional power converter based on Emulated Current Mode Control to evaluate the LM5116 controller IC. The evaluation board provides a 12V output with a 5A current capability. The operating input voltage ranges from 15V to 80V. The design operates at 250kHz, a good compromise between conversion efficiency and solution size. The printed circuit board consists of 4 layers, 2 ounce copper top and bottom, 1 ounce copper internal layers on FR4 material with a thickness of 0.06 inches. This application note contains the evaluation board schematic, Bill-of-Materials (BOM) and a quick setup procedure. Refer to the LM5116 datasheet for complete circuit design information.

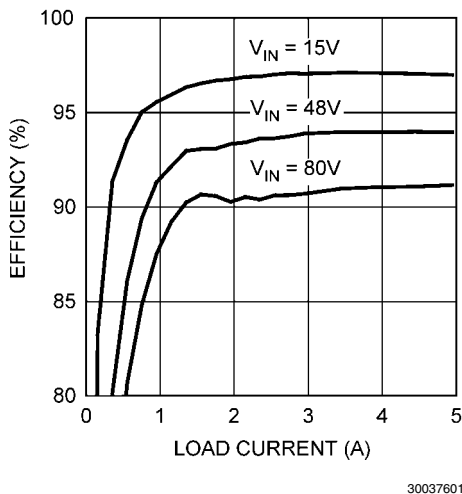

FIGURE 1. Efficiency with 10 µH Gowanda Inductor

The performance of the evaluation board is as follows:

Input Range: 15V to 80V

Output Voltage: 12V

Output Current: 0 to 5A

Frequency of Operation: 250 kHz

Board Size: 2.55 X 2.65 X 0.7 inches

Load Regulation: 1%

Line Regulation: 0.1%

Hiccup Mode Current Limit Protection

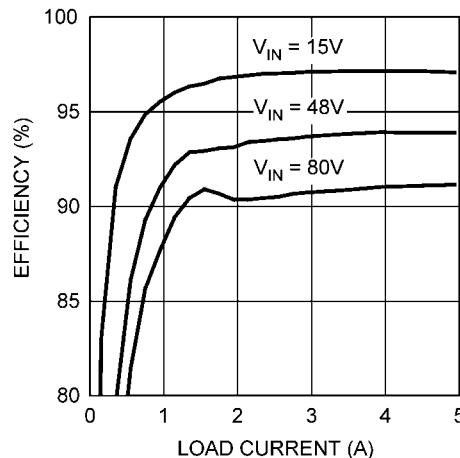

FIGURE 2. Efficiency with 10 µH Pulse Inductor

## Powering and Loading Considerations

Read this entire page prior to attempting to power the evaluation board.

### QUICK SETUP PROCEDURE

**Step 1:** Set the power supply current limit to 10A. Turn off the power supply. Connect the power supply to the V<sub>IN</sub> terminals.

**Step 2:** Connect the load, with a 5A capability, to the V<sub>OUT</sub> terminals. The positive connection goes to P3 and negative connection to P4.

**Step 3:** The EN pin should be left open for normal operation.

**Step 4:** Set V<sub>IN</sub> to 48V with no load applied. V<sub>OUT</sub> should be in regulation with a nominal 12V output.

**Step 5:** Slowly increase the load while monitoring the output voltage, V<sub>OUT</sub> should remain in regulation with a nominal 12V output as the load is increased up to 5 Amps.

**Step 6:** Slowly sweep the input voltage from 15V to 80V, V<sub>OUT</sub> should remain in regulation with a nominal 12V output.

**Step 7:** Temporarily short the EN pin to GND to check the shutdown function.

**Step 8:** Increase the load beyond the normal range to check current limiting. Hiccup mode current limit is used for protection. The peak short circuit current is limited to approximately 11A. Cooling is critical during this step.

**AIR FLOW**

Prolonged operation with high input voltage at full power will cause the MOSFETs to overheat. A stand-alone fan with at least 200 LFM should always be provided.

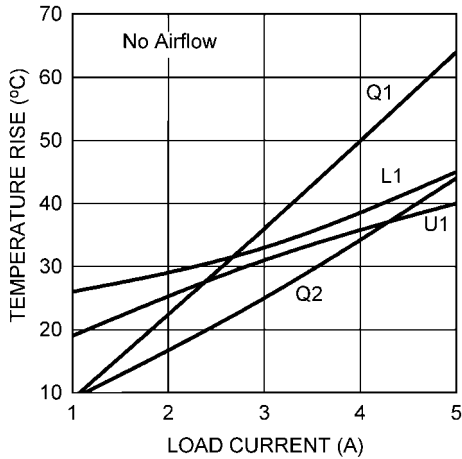

30037604

**FIGURE 3. Temperature Rise at 48V<sub>IN</sub> with 10 µH Gowanda Inductor**

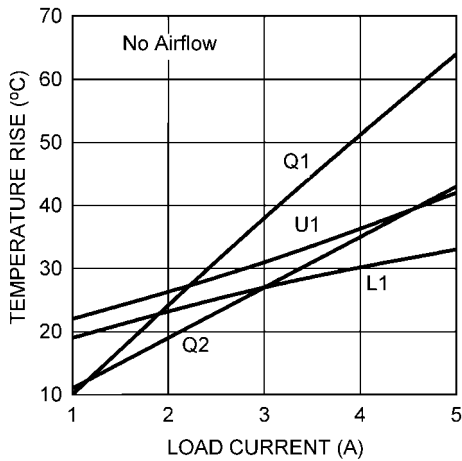

30037605

**FIGURE 4. Temperature Rise at 48V<sub>IN</sub> with 10 µH Pulse Inductor**

**POWERING UP**

Using the enable pin provided will allow powering up the source supply with the current level set low. It is suggested that the load be kept low during the first power up. Set the current limit of the source supply to provide about 1.5 times the anticipated wattage of the load. As you remove the connection from the enable pin to ground, immediately check for 12 volts at the output.

A quick efficiency check is the best way to confirm that everything is operating properly. If something is amiss you can be reasonably sure that it will affect the efficiency adversely. Few parameters can be incorrect in a switching power supply without creating losses and potentially damaging heat.

**OVER CURRENT PROTECTION**

The evaluation board is configured with hiccup mode over-current protection. This helps to limit the thermal stress while in an overloaded condition. If a sustained overload is expected before the onset of hiccup mode, ensure that sufficient cooling (airflow) is maintained. The peak short circuit current is limited to approximately 11A.

For sustained short circuit protection, a counter trips the internal fault timer when a current limit condition exists for more than 256 clock cycles. C7 sets the off-time of the current limit fault timer, which may be lengthened by increasing the value of C7. D2 is used to discharge C7 in the event of a fast decay of the input voltage. Though not recommended, the hiccup fault timer may be disabled by removing C7.

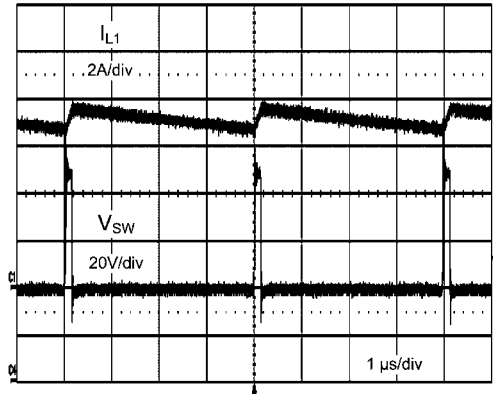

30037606

**FIGURE 5. Short Circuit at 48V<sub>IN</sub>**

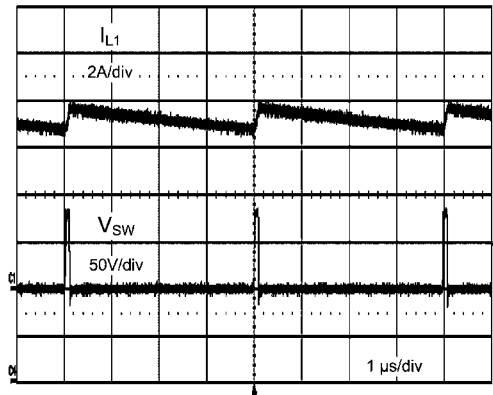

30037607

**FIGURE 6. Short Circuit at 80V<sub>IN</sub>**

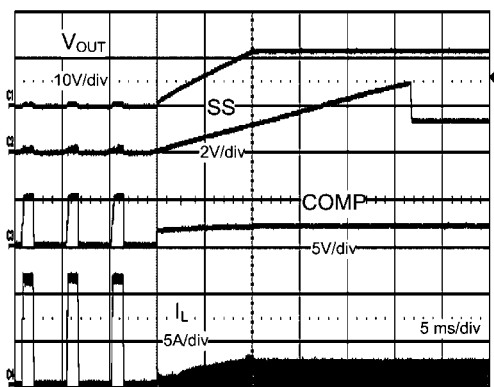

30037608

**FIGURE 7. Short Circuit Recovery into Resistive Load**

### SYNCHRONIZATION

A SYNC pin has been provided on the evaluation board. This pin can be used to synchronize the regulator to an external clock. Refer to the LM5116 datasheet for complete information

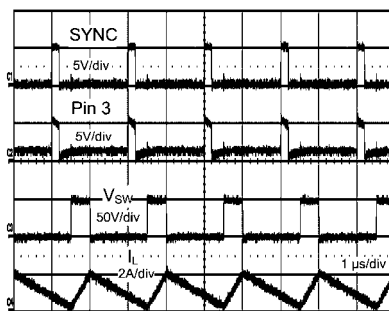

30037609

**FIGURE 8. Synchronization at 48V<sub>IN</sub>**

### ACTIVE LOADS

Figure 13 shows a typical start-up characteristic into a constant current active load. This type of load can exhibit an initial short circuit, which is sustained well beyond the duration of the fault timer. Increasing the soft-start time improves the ability to start into this type of load. For the extreme case, the hiccup fault timer may be disabled by removing C7. A sustained short circuit should be avoided when the fault timer is not used.

# Typical Performance Waveforms

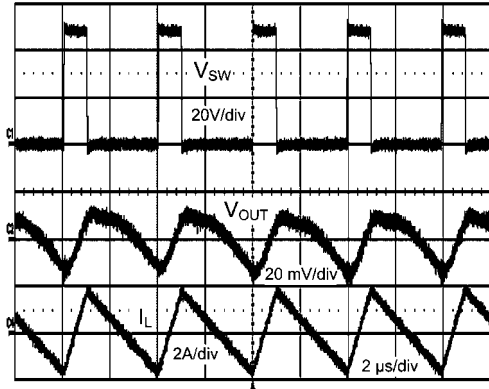

30037610

FIGURE 9. Synchronous Operation at 48V<sub>IN</sub> with JMP1 Removed

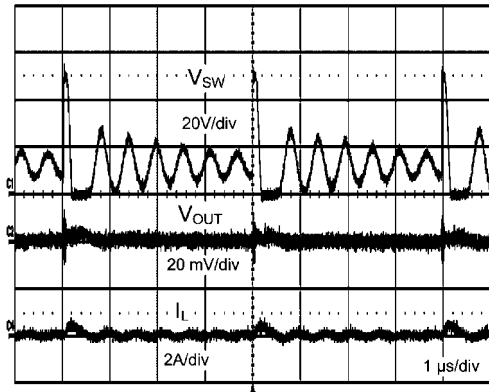

30037612

FIGURE 10. Discontinuous Operation using Diode Emulation Mode at 48V<sub>IN</sub> with JMP1 Installed

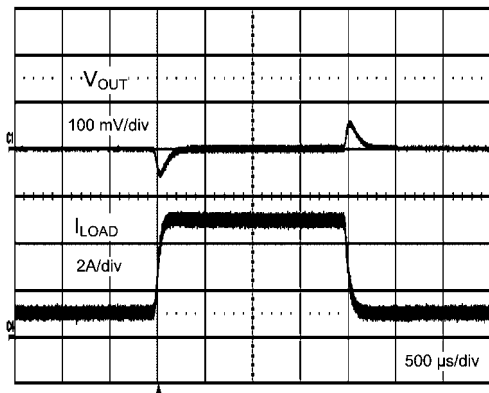

30037614

FIGURE 11. Transient Response at 48V<sub>IN</sub>

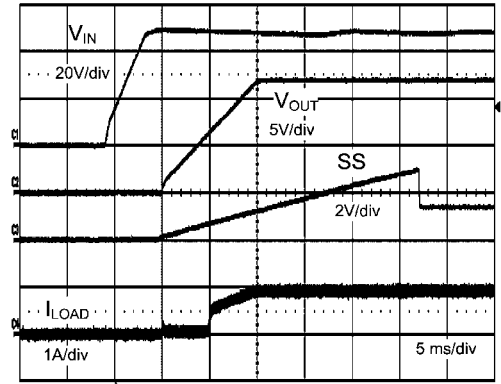

30037611

FIGURE 12. Start-up into Resistive Load at 48V<sub>IN</sub>

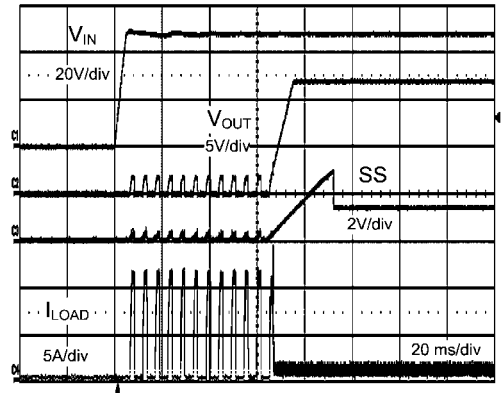

30037613

FIGURE 13. Start-up into Active Load at 48V<sub>IN</sub>

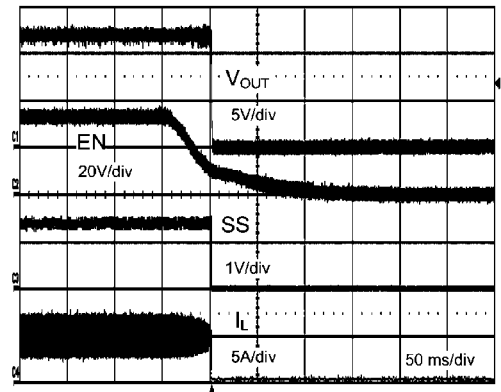

30037615

FIGURE 14. Shut Down at 48V<sub>IN</sub>

# Evaluation Board Schematic

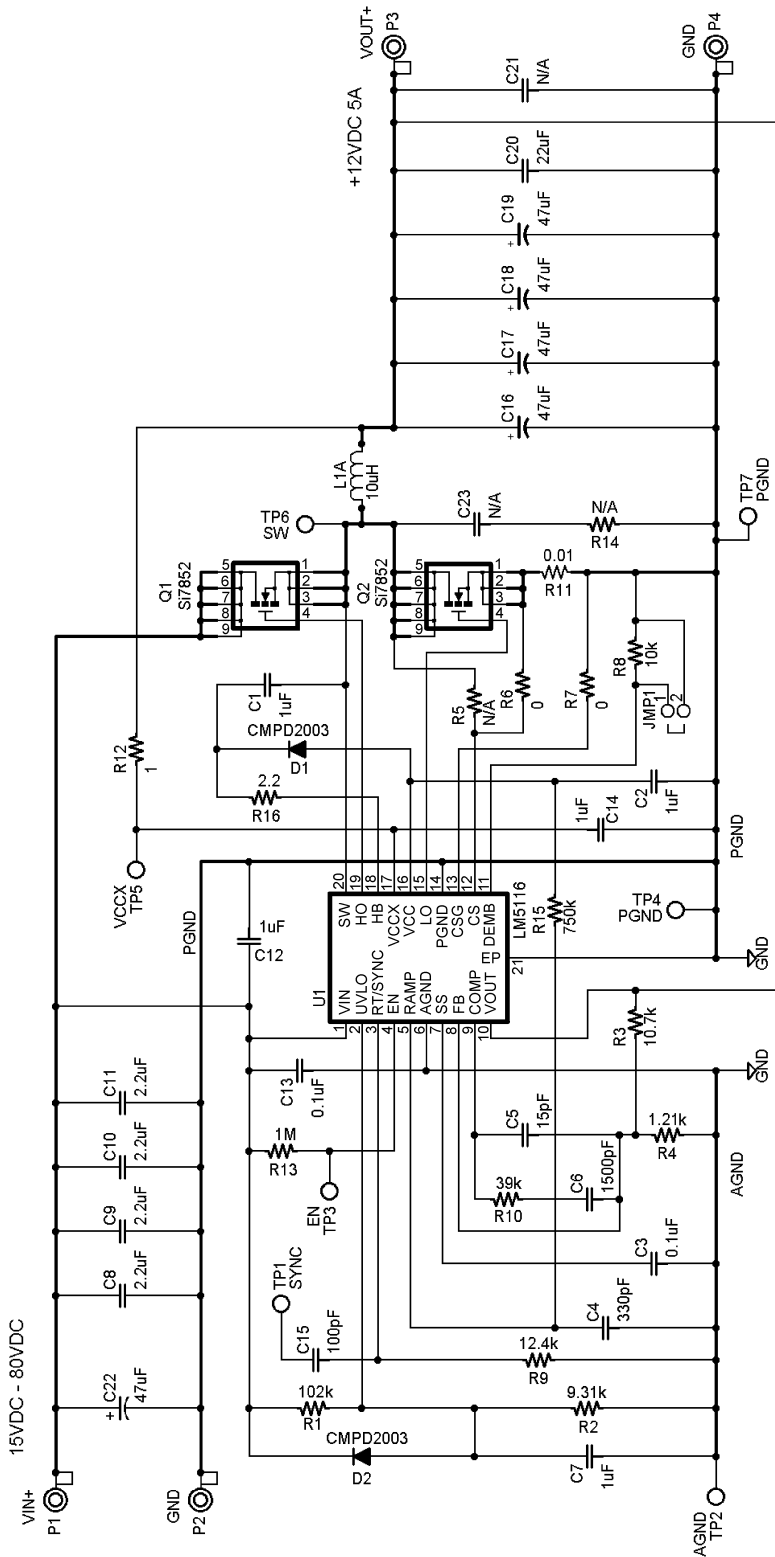

30037603

FIGURE 15.

**TABLE 1. Bill of Materials for 15V - 80V Input, 12V 5A Output, 250kHz**

ID	Part Number	Type	Size	Parameters	Qty	Vendor
C1, C2, C14	C2012X7R1E105K	Capacitor, Ceramic	0805	1 $\mu$ F, 25V, X7R, 10%	3	TDK
C3	C1608X7R1H104K	Capacitor, Ceramic	0603	0.1 $\mu$ F, 50V, X7R, 10%	1	TDK
C4	VJ0603A331JXAA	Capacitor, Ceramic	0603	330 pF, 50V, COG, 5%	1	Vishay
C5	VJ0603A150KXAA	Capacitor, Ceramic	0603	15 pF, 50V, COG, 10%	1	Vishay
C6	VJ0603Y152KXXA	Capacitor, Ceramic	0603	1500 pF, 25V, X7R, 10%	1	Vishay
C7	C1608X7R1C105K	Capacitor, Ceramic	0603	1 $\mu$ F, 16V, X7R, 10%	1	TDK
C8, C9, C10, C11	C4532X7R2A225M	Capacitor, Ceramic	1812	2.2 $\mu$ F, 100V X7R, 20%	4	TDK
C12	C3225X7R2A105M	Capacitor, Ceramic	1210	1 $\mu$ F, 100V X7R, 20%	1	TDK
C13	C2012X7R2A104K	Capacitor, Ceramic	0805	0.1 $\mu$ F, 100V X7R, 10%	1	TDK
C15	VJ0603A101KXAA	Capacitor, Ceramic	0603	100 pF, 50V, COG, 10%	1	Vishay
C16, C17, C18, C19	T520D476M016ATE035	Capacitor, Polymer	D Case	47 $\mu$ F, 16V, 35m $\Omega$	4	KEMET
C20	C4532X7R1C226M	Capacitor, Ceramic	1812	22 $\mu$ F, 16V, X7R, 20%	1	TDK
C21		Capacitor, Ceramic	1812	Not Used	0	
C22	EEV-FK2A470Q	Capacitor, Electrolytic	SMD	47 $\mu$ F, 100V, Case Size: 12.5mm X 13.5mm	1	Panasonic
C23		Capacitor, Ceramic	0805	Not Used	0	
D1, D2	CMPD2003	Diode, Switching	SOT-23	200 mA, 200V	2	Central Semi
JMP1		Connector, Jumper		2 pin sq. post	1	
L1	121KM1002H	Inductor		10 $\mu$ H, 8.72A, 10 m $\Omega$	1	Gowanda
L1A	PA2050.103NL	Inductor		10 $\mu$ H, 14.7A, 5.8 m $\Omega$	0	Pulse
P1-P4	1514-2	Turret Terminal	.090" dia.		4	Keystone
TP1-TP7	5012	Test Point	.040" dia.		7	Keystone
Q1, Q2	Si7852DP	N-CH MOSFET	SO-8 Power PAK	12.5A, 80V, 22 m $\Omega$	2	Vishay Siliconix
R1	CRCW06031023F	Resistor	0603	102 k $\Omega$ , 1%	1	Vishay
R2	CRCW06039311F	Resistor	0603	9.31 k $\Omega$ , 1%	1	Vishay
R3	CRCW06031072F	Resistor	0603	10.7 k $\Omega$ , 1%	1	Vishay
R4	CRCW06031211F	Resistor	0603	1.21 k $\Omega$ , 1%	1	Vishay
R5		Resistor	0603	Not Used	0	
R6, R7	CRCW06030R0J	Resistor	0603	0 $\Omega$	2	Vishay
R8	CRCW0603103J	Resistor	0603	10 k $\Omega$ , 5%	1	Vishay
R9	CRCW06031242F	Resistor	0603	12.4 k $\Omega$ , 1%	1	Vishay
R10	CRCW0603393J	Resistor	0603	39 k $\Omega$ , 5%	1	Vishay
R11	LRC-LRF2010-01-R010-F	Resistor	2010	0.010 $\Omega$ , 1%	0	IRC
R11	WSL2010R0100FEA	Resistor	2010	0.010 $\Omega$ , 1%	1	Vishay
R12	CRCW06031R0J	Resistor	0603	1 $\Omega$ , 5%	1	Vishay
R13	CRCW0603105J	Resistor	0603	1 M $\Omega$ , 5%	1	Vishay
R14		Resistor	1206	Not Used	0	
R15	CRCW06037503F	Resistor	0603	750 k $\Omega$ , 1%	1	Vishay
R16	CRCW06032R2J	Resistor	0603	2.2 $\Omega$ , 5%	1	Vishay
U1	LM5116MHX	Synchronous Buck Controller	TSSOP-20EP		1	NSC

# PCB Layout

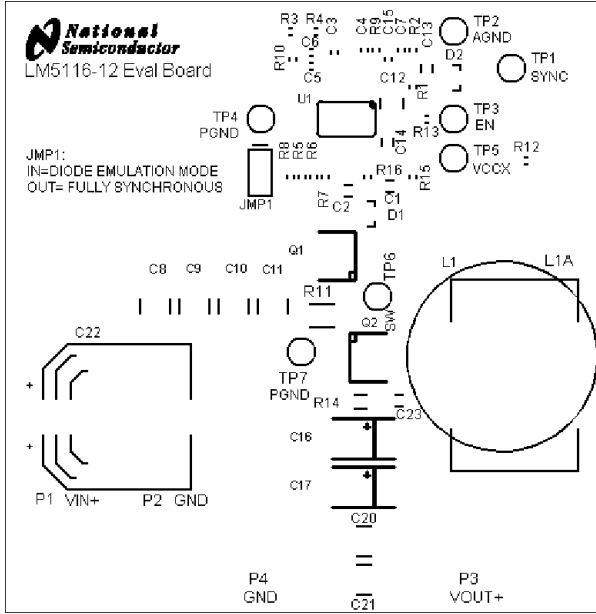

TOP SILKSCREEN (.PLC) AS VIEWED FROM TOP  
880013185-002

30037616

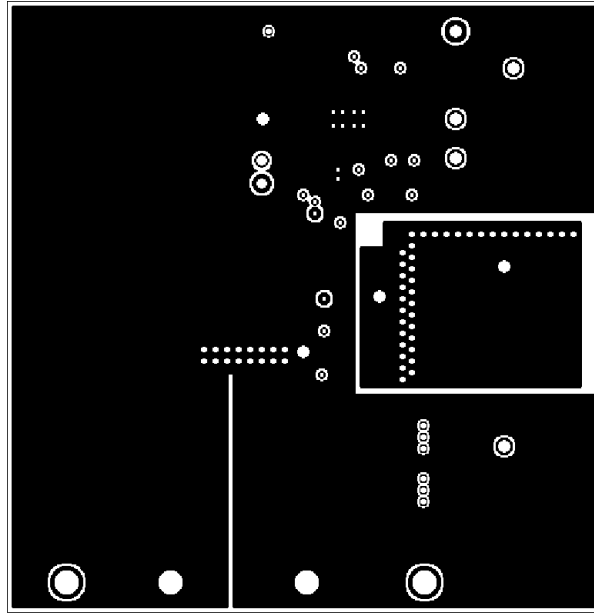

LAYER 2 (LY2) AS VIEWED FROM TOP  
880013185-002

30037617

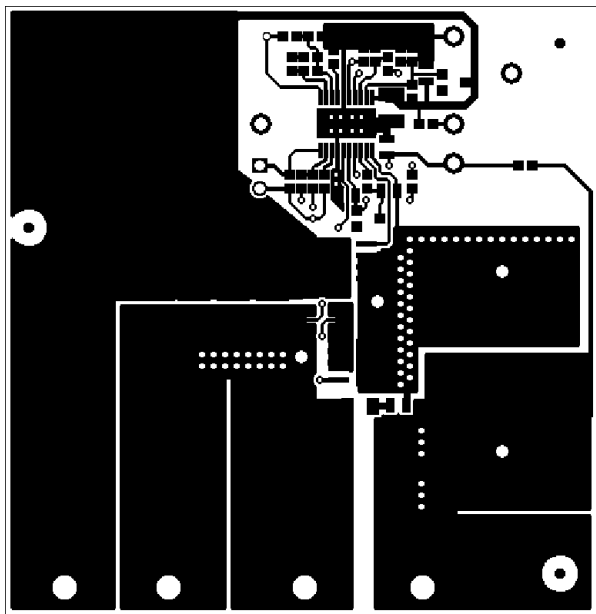

TOP (.CMP) LAYER AS VIEWED FROM TOP  
880013185-002

30037618

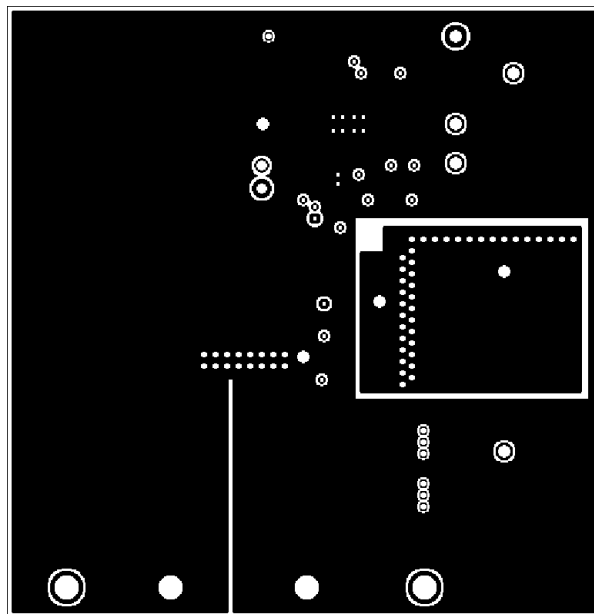

LAYER 3 (LY3) AS VIEWED FROM TOP  
880013185-002

30037619

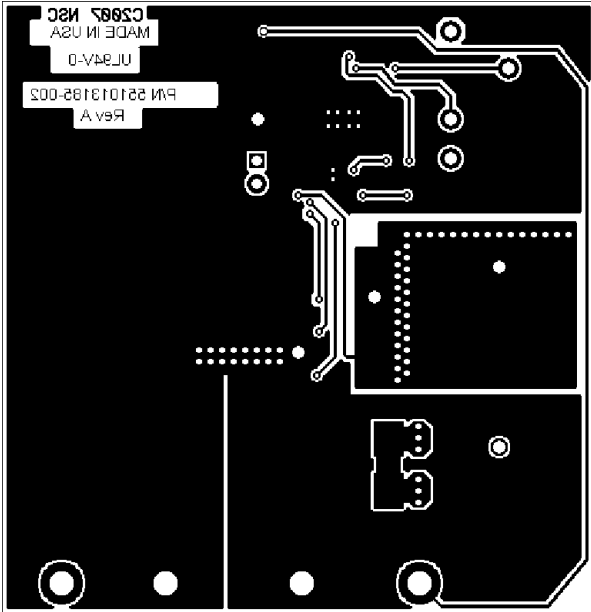

BOTTOM (.SOL) LAYER AS VIEWED FROM TOP  
880013185-002

30037620

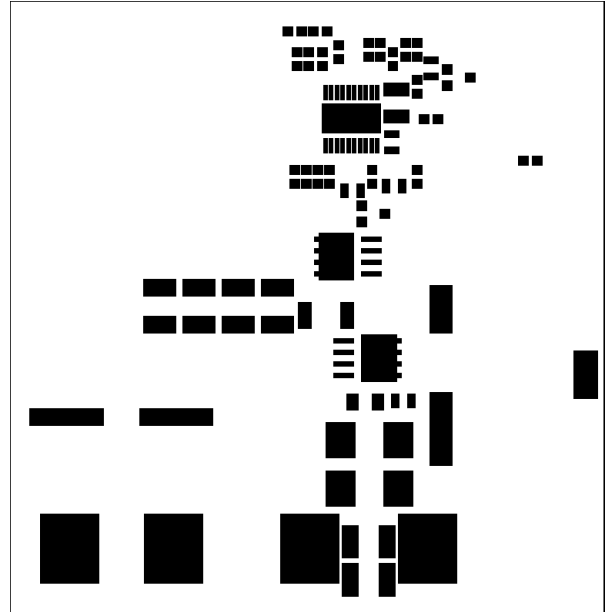

TOP SOLDER PASTE MASK (.CRC) AS VIEWED FROM TOP  
881013185-002

30037621

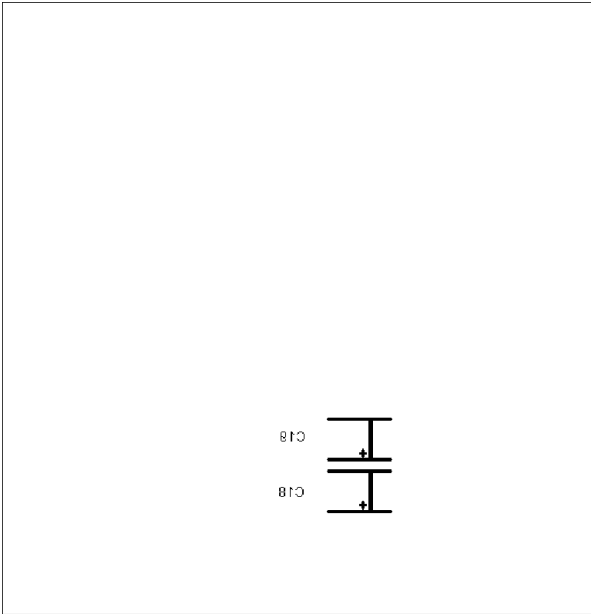

BOTTOM SILK SCREEN (.PLS) LAYER AS VIEWED FROM TOP  
880013185-002

30037622

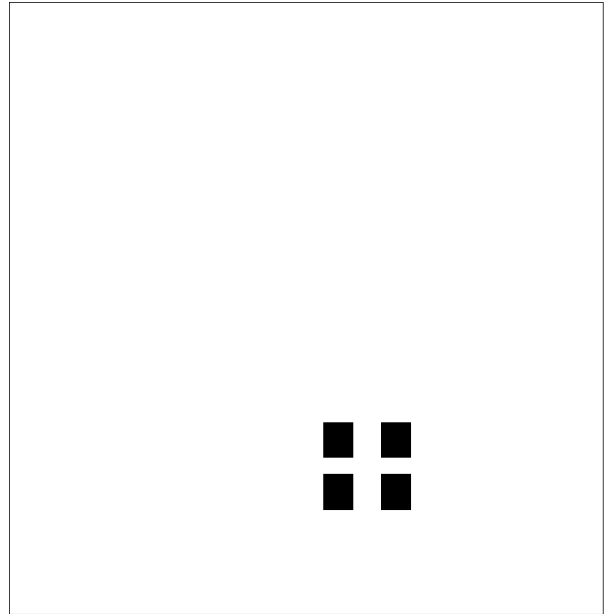

BOTTOM SOLDER PASTE MASK (.CRS) LAYER AS VIEWED FROM TOP  
881013185-002

30037623



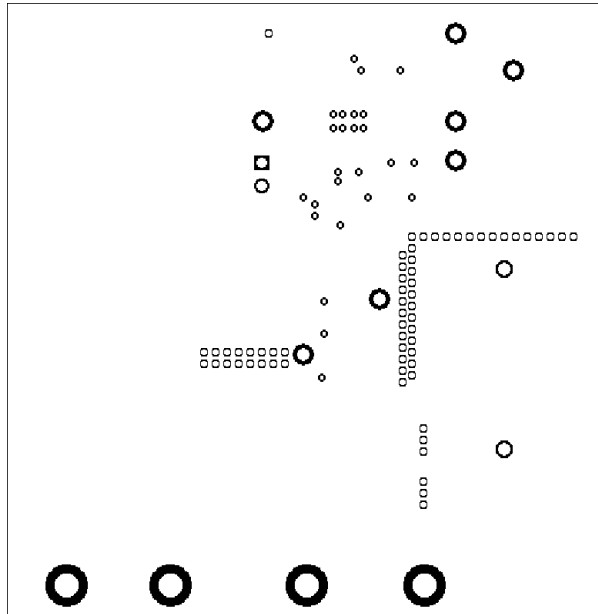
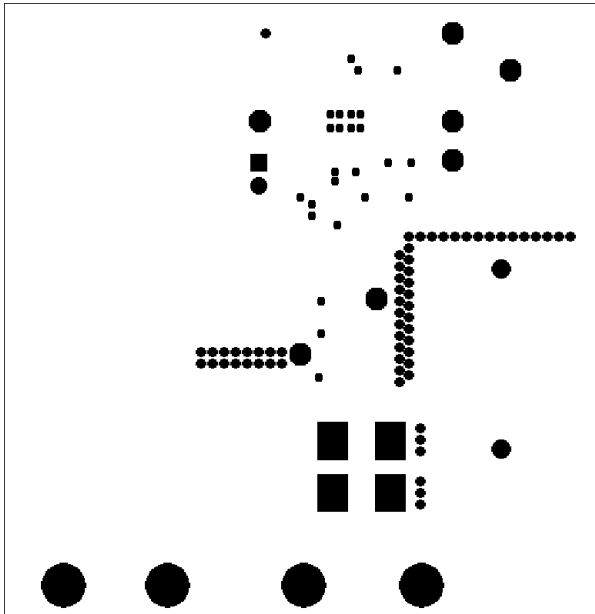

BOTTOM SOLDER MASK (.STS) LAYER AS VIEWED FROM TOP  
880013185-002

30037625

30037624

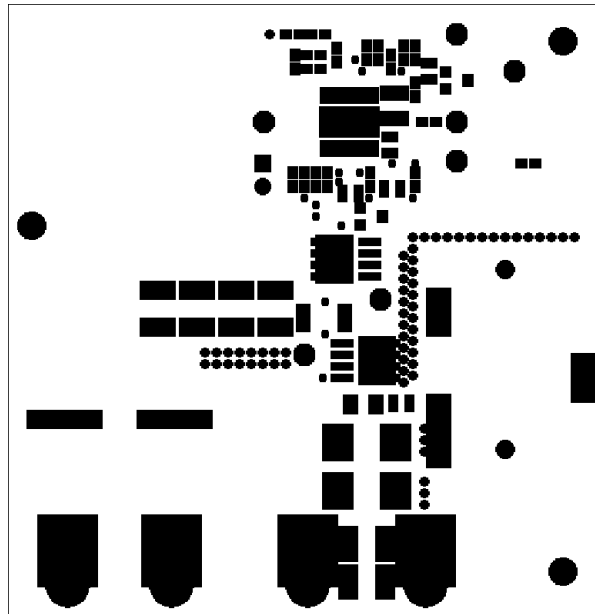

TOP SOLDERMASK (.STC) LAYER AS VIEWED FROM TOP  
880013185-002

30037626

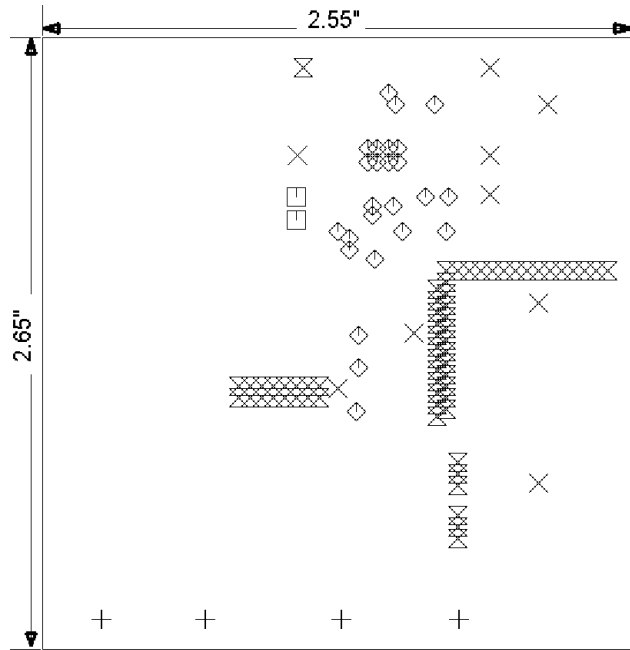

DRILLS AND DIMENSIONS (.FAB) LAYER AS VIEWED FROM TOP  
880013185-002

DRILL GUIDE	
+	0.014, +0.002, -0.002 INCHES
△	0.018, +0.002, -0.002 INCHES
◻	0.038, +0.003, -0.003 INCHES
×	0.047, +0.003, -0.002 INCHES
▽	0.100, +0.005, -0.002 INCHES

30037627

# Notes

AN-1713

## Notes

THE CONTENTS OF THIS DOCUMENT ARE PROVIDED IN CONNECTION WITH NATIONAL SEMICONDUCTOR CORPORATION ("NATIONAL") PRODUCTS. NATIONAL MAKES NO REPRESENTATIONS OR WARRANTIES WITH RESPECT TO THE ACCURACY OR COMPLETENESS OF THE CONTENTS OF THIS PUBLICATION AND RESERVES THE RIGHT TO MAKE CHANGES TO SPECIFICATIONS AND PRODUCT DESCRIPTIONS AT ANY TIME WITHOUT NOTICE. NO LICENSE, WHETHER EXPRESS, IMPLIED, ARISING BY ESTOPPEL OR OTHERWISE, TO ANY INTELLECTUAL PROPERTY RIGHTS IS GRANTED BY THIS DOCUMENT.

TESTING AND OTHER QUALITY CONTROLS ARE USED TO THE EXTENT NATIONAL DEEMS NECESSARY TO SUPPORT NATIONAL'S PRODUCT WARRANTY. EXCEPT WHERE MANDATED BY GOVERNMENT REQUIREMENTS, TESTING OF ALL PARAMETERS OF EACH PRODUCT IS NOT NECESSARILY PERFORMED. NATIONAL ASSUMES NO LIABILITY FOR APPLICATIONS ASSISTANCE OR BUYER PRODUCT DESIGN. BUYERS ARE RESPONSIBLE FOR THEIR PRODUCTS AND APPLICATIONS USING NATIONAL COMPONENTS. PRIOR TO USING OR DISTRIBUTING ANY PRODUCTS THAT INCLUDE NATIONAL COMPONENTS, BUYERS SHOULD PROVIDE ADEQUATE DESIGN, TESTING AND OPERATING SAFEGUARDS.

EXCEPT AS PROVIDED IN NATIONAL'S TERMS AND CONDITIONS OF SALE FOR SUCH PRODUCTS, NATIONAL ASSUMES NO LIABILITY WHATSOEVER, AND NATIONAL DISCLAIMS ANY EXPRESS OR IMPLIED WARRANTY RELATING TO THE SALE AND/OR USE OF NATIONAL PRODUCTS INCLUDING LIABILITY OR WARRANTIES RELATING TO FITNESS FOR A PARTICULAR PURPOSE, MERCHANTABILITY, OR INFRINGEMENT OF ANY PATENT, COPYRIGHT OR OTHER INTELLECTUAL PROPERTY RIGHT.

### LIFE SUPPORT POLICY

**NATIONAL'S PRODUCTS ARE NOT AUTHORIZED FOR USE AS CRITICAL COMPONENTS IN LIFE SUPPORT DEVICES OR SYSTEMS WITHOUT THE EXPRESS PRIOR WRITTEN APPROVAL OF THE CHIEF EXECUTIVE OFFICER AND GENERAL COUNSEL OF NATIONAL SEMICONDUCTOR CORPORATION.** As used herein:

Life support devices or systems are devices which (a) are intended for surgical implant into the body, or (b) support or sustain life and whose failure to perform when properly used in accordance with instructions for use provided in the labeling can be reasonably expected to result in a significant injury to the user. A critical component is any component in a life support device or system whose failure to perform can be reasonably expected to cause the failure of the life support device or system or to affect its safety or effectiveness.

National Semiconductor and the National Semiconductor logo are registered trademarks of National Semiconductor Corporation. All other brand or product names may be trademarks or registered trademarks of their respective holders.

Copyright© 2007 National Semiconductor Corporation

For the most current product information visit us at [www.national.com](http://www.national.com)



**National Semiconductor Americas Customer Support Center**  
 Email: [new.feedback@nsc.com](mailto:new.feedback@nsc.com)  
 Tel: 1-800-272-9959

**National Semiconductor Europe Customer Support Center**  
 Fax: +49 (0) 180-530-85-86  
 Email: [europe.support@nsc.com](mailto:europe.support@nsc.com)  
 Deutsch Tel: +49 (0) 69 9508 6208  
 English Tel: +49 (0) 870 24 0 2171  
 Français Tel: +33 (0) 1 41 91 8790

**National Semiconductor Asia Pacific Customer Support Center**  
 Email: [ap.support@nsc.com](mailto:ap.support@nsc.com)

**National Semiconductor Japan Customer Support Center**  
 Fax: 81-3-5639-7507  
 Email: [jpn.feedback@nsc.com](mailto:jpn.feedback@nsc.com)  
 Tel: 81-3-5639-7560