

**Evaluation Board for RS2051
--- 36W (12V, 3A) Adapter**

Contents

I . Schematic..... 3

II .BOM..... 4

III. Gerber file 5

IV. Transformer specification..... 7

V. Test Report..... 8

I . Schematic

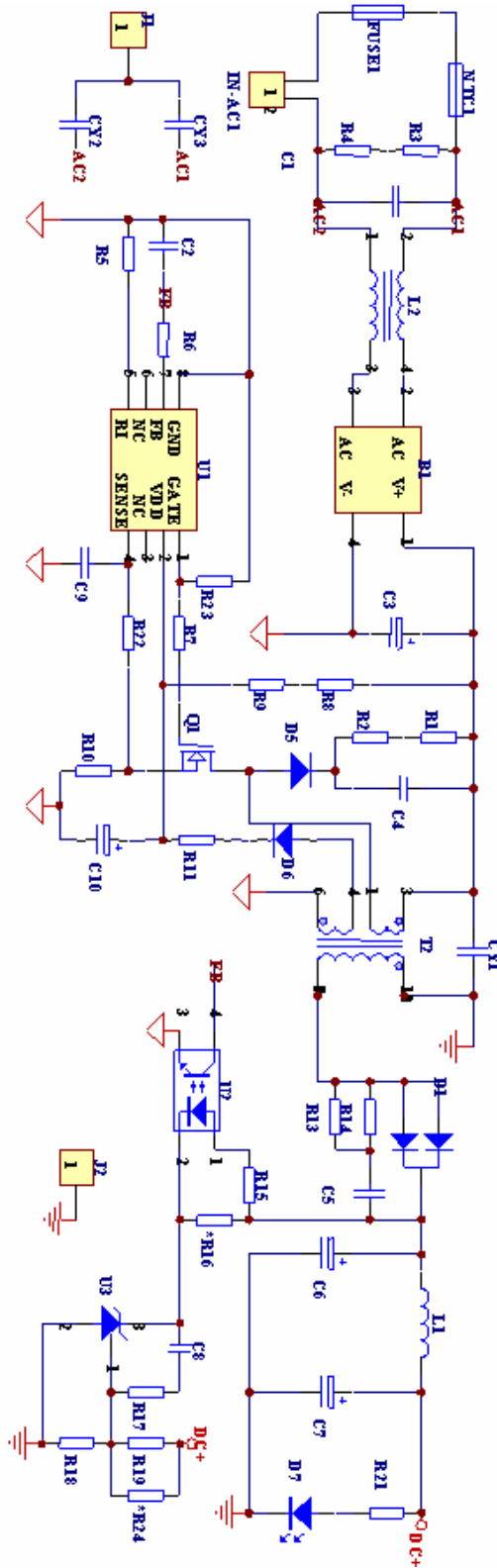

II. BOM

DESIGNATOR	DESCRIPTION	NOTE	DESIGNATOR	DESCRIPTION	NOTE
B1	KBP406	BRIGE	R1	47K	1206
C1	0.1u/~275V	RAD0.6-0.3	R2	47K	1206
C2	103/63V	18*6*12(L*W*H)	R3	750K	1206
C3	82uF/400V	Φ18*33	R4	750K	1206
C4	103/1KV		R5	100K	1/4W
C5	102	0805	R6	680R	1206
C6	1000uF/25V	松下银字 Φ10*20	R7	47R	1206
C7	1000uF/25V	松下银字 Φ10*20	R8	750K	1206
C8	104	0805	R9	750K	1206
*C9	101	OPEN 0805	R10	0R75	2W
C10	22uF/50V	Φ5*12	R11	10R	1206
CY1	222/1KV		R13	47R	1206
*CY2	223/1KV	OPEN	R14	47R	1206
*CY3	223/1KV	OPEN	R15	3.3K	0805
					OPEN
D1	Y2010	TO220	*R16	2K2	0805
D5	FR107	DIODE	R17	10K	0805
D6	FR102	DIODE	R18	10K	0805
D7	LED	Φ3	R19	39K	1/4W
FUSE1	F2A/250V	FUSE	R21	3K3	0805
IN-AC1	CON2	POWER_ACIN	R22	510R	1/4W
*J1	CON1	PAD	R23	100K	1206
					OPEN
*J2	CON1	PAD	*R24	1.5M	1/4W
L1	10uH	Φ8*12/2.5A	T2	EPQ2620	EPQ26-20
L2	20MH /1A	18*16*20(L*W*H)	U1	RS2051	DIP8/SOT6
NTC1	5D-9	NTC	U2	PC817B	DIP4
Q1	5N60	TO220	U3	RS431	TO92

IV. Gerber file:

Silkscreen Top

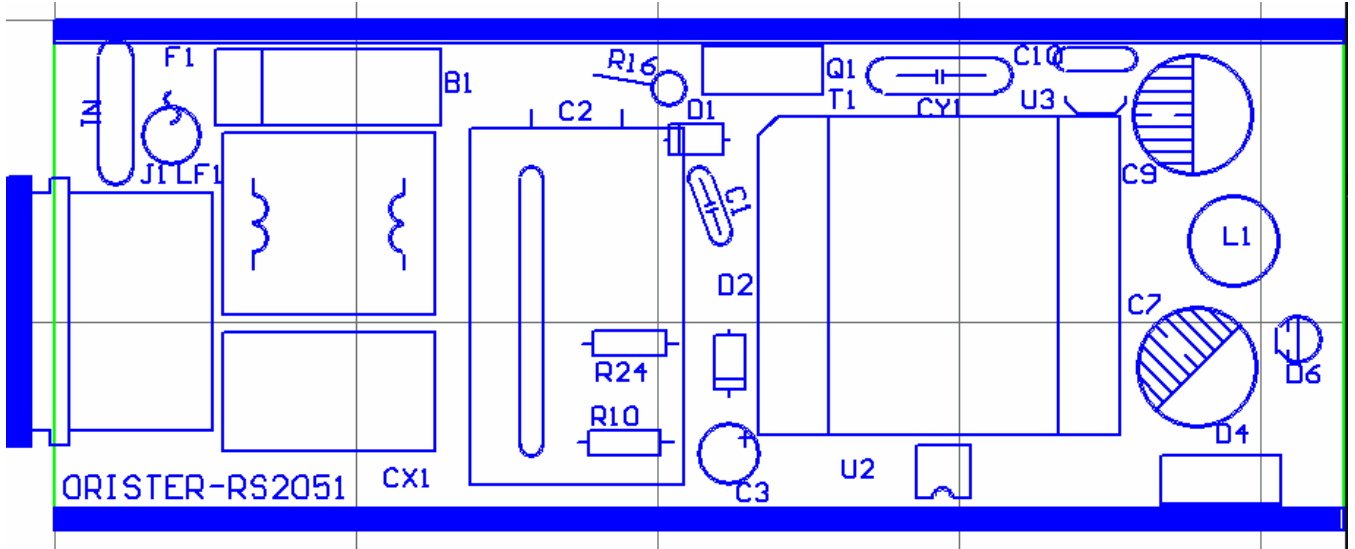

Silkscreen Bottom

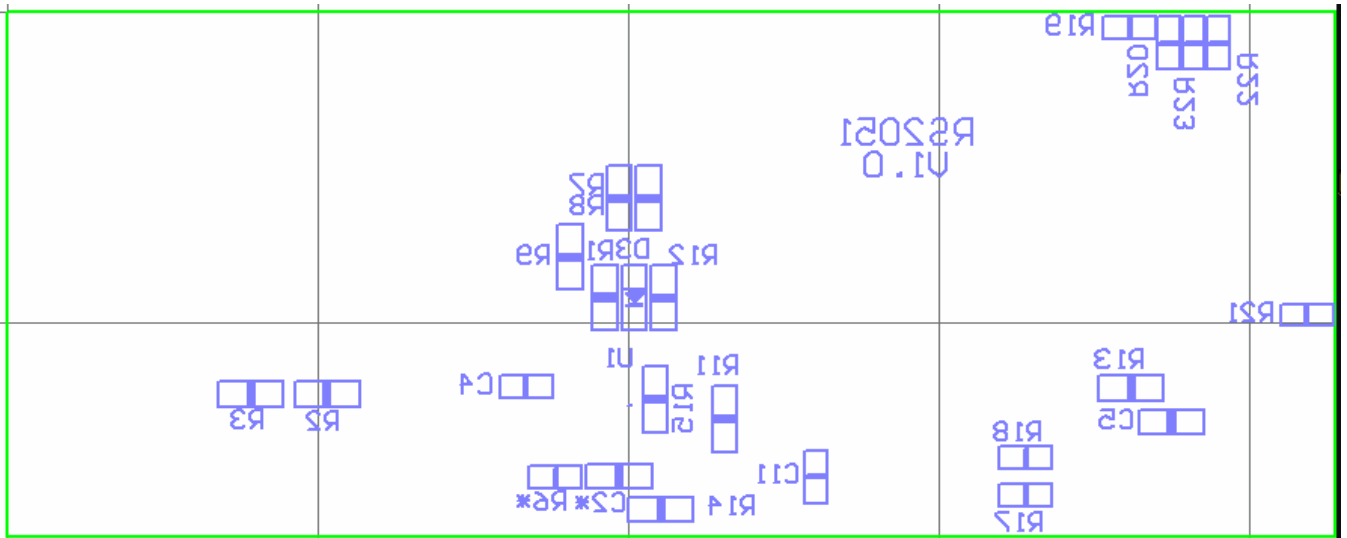

Bottom Layer

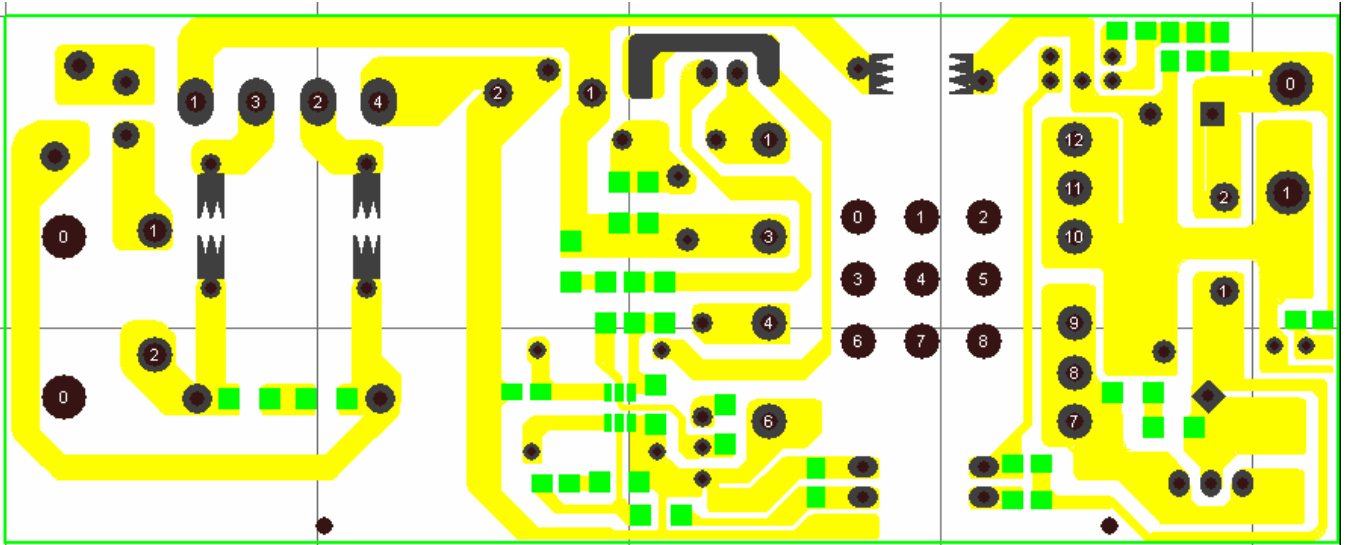

Solder mask Bottom

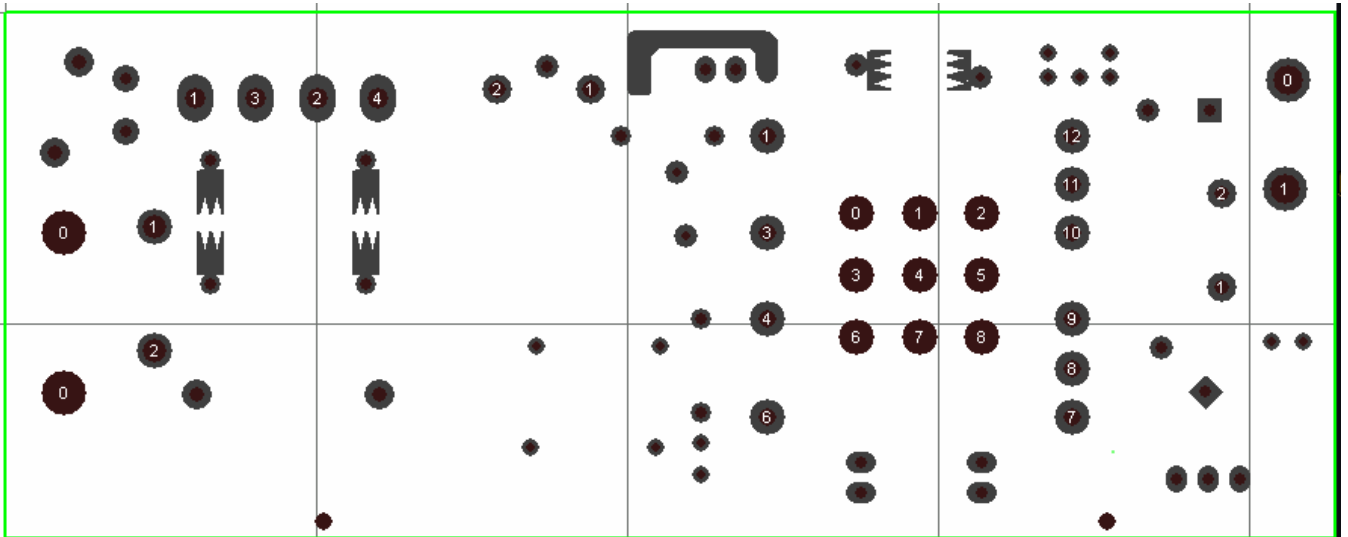

V. Transformer specification:

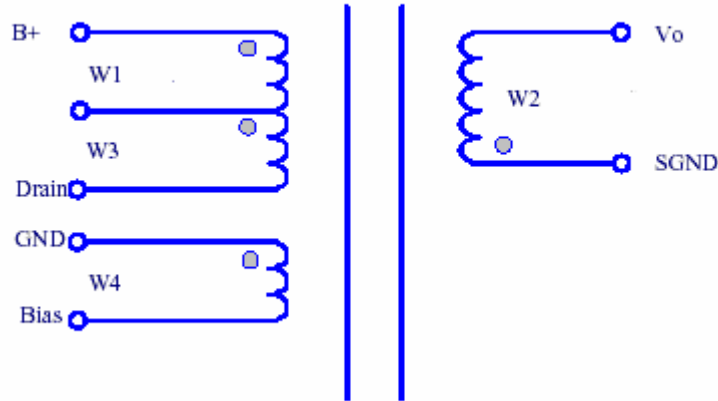

Core & Bobbin	Winding	Wire Gauge(mm)	Turns
PQ26-20	W1	0.38*2	20
	W2	0.41*3	7
	W3	0.38*2	20
	W4	0.18*1	9

NOTE: N1(W1+W3) inductance=850uH

I . EXECUTIVE SUMMARY.....	9
1. INPUT VOLTAGE & FREQUENCY	10
2. OUTPUT LOADS.....	10
3. TURN ON DELAY TIME.....	10
4. GREEN MODE CONSUMPTION	11
5. OPERATING EFFICIENCY.....	11
6. LINE/LOAD REGULATION	11
7. OUTPUT DYNAMIC RESPONSE	12
8. PEAK TO PEAK OUTPUT RIPPLE AND NOISE.....	13
9. OVER CURRENT PROTECTION.....	15
10. OUTPUT SHORT PROTECTION.....	16

I . EXECUTIVE SUMMARY

TEST	Result	Comments
Turn On Delay Time	Pass	
Green Mode Power Consumption	Pass	
Operating Efficiency	Pass	
Line/Load Regulation	Pass	
Output Dynamic Response	Pass	
Peak to Peak Output Ripple and Noise	Pass	
Over Current Protection	Pass	
Output Short Protection	Pass	

1. Input Voltage & Frequency

The unit shall be capable of operating as a universal AC input power supply accepting AC inputs. The power supply shall operate between the following two voltages (90V to 264V). The supply will be designed to operate for a Table 1.

Minimum	Normal	Maximum
90Vac	110Vac	242Vac

Table 1

2. Output Loads

The loads and regulation for each of the outputs are shown in Table. 2.

Parameter	Output Voltage			Output Current	
	Minimum	Normal	Maximum	Minimum	Maximum
+12V	11.5V	12.0V	12.5	0A	3A
Load Regulation	/	/	±1%	0A	3A
Load Dynamic	11.5V	12.0V	12.5	/	0~100%

3. Turn On Delay Time

Turn on delay time will be less than 4 seconds at full load. Turn on delay time is measured as the delay between input voltage being applied at 0° phase angle and when the outputs arrive within 10% of their operating value. Turn on delay time is measured using an input voltage of 90VAC(rms) and input frequency of 60Hz.

Test Conditions:

Input: 90Vac

Output: 2.5A

Ambient Temperature : 25°C

Test Result: PASS

Input	T _{turn on delay} (s)
90Vac	1.44

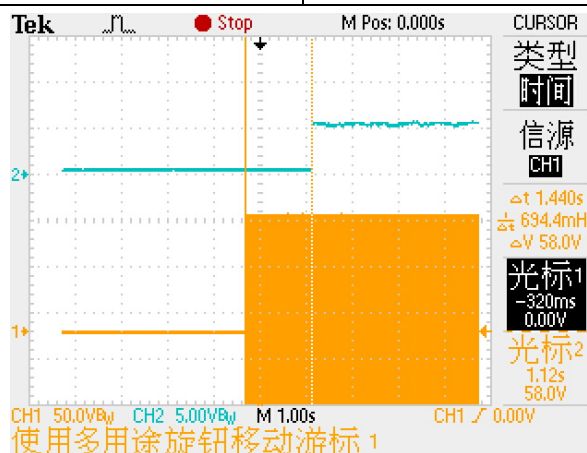

4. Green Mode Consumption

The input power of power supply shall remain less than 300mW under output at no load conditions.

Test Condition:

Input : 90Vac/242Vac

Output : No Load

Ambient Temperature: 25°C

Test Result: PASS

V _{in} (Vac)	P _{in} (mW)	V _o (Vdc)
90	110	12.272
242	240	12.269

Table 4

5. Operating Efficiency

The operating efficiency is defined to be the percent ratio of the output power to the input power when the input and output (voltage and current) are within the min and max values as specified in tables 1 and table 2. Operating efficiency shall be calculated by measuring the output power of the supply and remain minimum 85%.

Test Condition:

Input: 90~242Vac

Output: 3A

Ambient Temperature: 25°C

Test Result: PASS

V _{in} (Vac)	P _{in} (W)	V _o (Vdc)	I _o (A)	P _o (W)	Efficiency(%)
90	41.92	12.092	3	36.29	86.6
110	41.67	12.091	3	36.29	86.9
220	40.16	11.955	3	35.87	87.0
242	40.12	11.934	3	35.81	89.2.

6. Line/Load Regulation

Line/Load regulation is defined to be the percent change in output voltage versus the nominal voltage due to a change in DC load within Hi/Lo line operating range. Line/Load regulation to be measured at Min. Typical and Max output voltages.

Test Conditions:

Input: 90Vac/242Vac (60Hz)

Output: +5V=0A/1A/2A

Ambient Temperature : 25°C

Test Result: PASS

Output load(A)		Vo(Vdc) Reading	
		90Vac	242Vac
0		12.272	12.276
0.75		12.203	12.204
1.5		12.178	12.182
2.25		12.123	12.110
3		12.092	11.934
Reading Variation(%)	Max	0.18	0.342
	Min		
Spec		±2.8%	

7. Output Dynamic Response

The dynamic of the output response refers to the change in output voltage to a step increase in the current of 50% & 100% load shall maintain the specified regulation. The current slew rate under output load dynamic shall be 1A/ μ s.

Test Conditions:

Input: 90Vac / 242Vac (60Hz)

Ambient Temperature : 25°C

Test Result: PASS

8. Peak to Peak Output Ripple and Noise

This refers to the peak-to-peak residual AC that remains on the DC power line after passing through all the filtering processes conducted within the power supply. The peak to peak output ripple and noise shall be considered to comprise of the complex envelope of the low frequency saw tooth voltage ripple and the high frequency switching noise. It shall be within 100mV and measured across output terminals using a single ended measurement with an oscilloscope (bandwidth limited to 20 MHz) and a high persistence display. Readings shall be made through the range of minimum to maximum load current.

Test Condition:

Input : 90Vac/242Vac (60Hz)

Output : Max/Min Load

Ambient Temperature : 25°C

Test Result: PASS

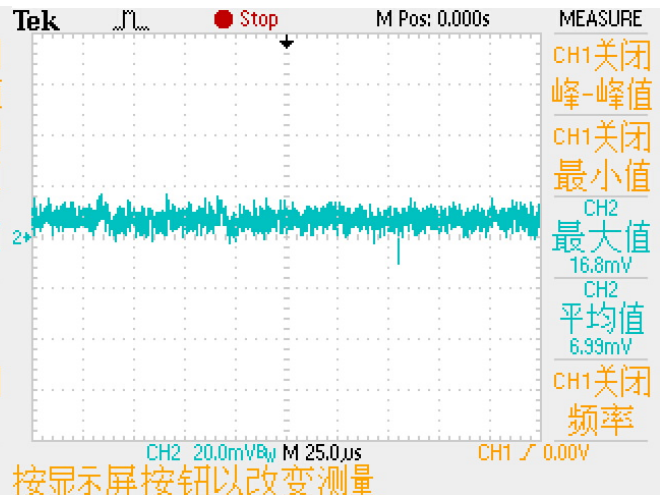
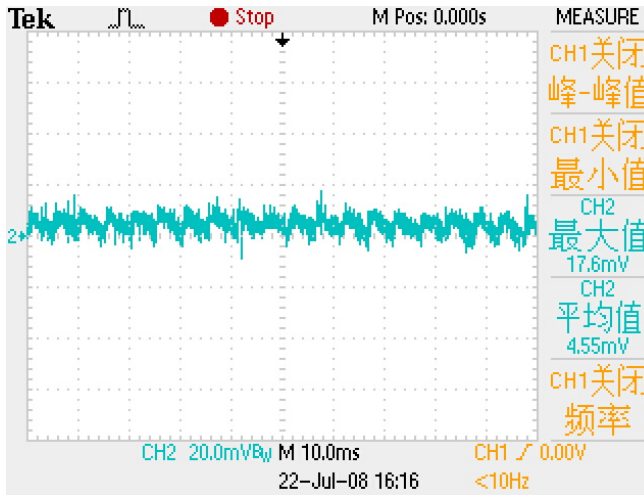

Output Ripple/Noise Test

Vin : 90Vac

O/P: +12V=0A

CH2 : VP-P+12V

Reading :17.6mV

Output Noise Test

Vin : 90Vac

O/P: +12V=0A

CH2 : VP-P+12V

Reading :16.8mV

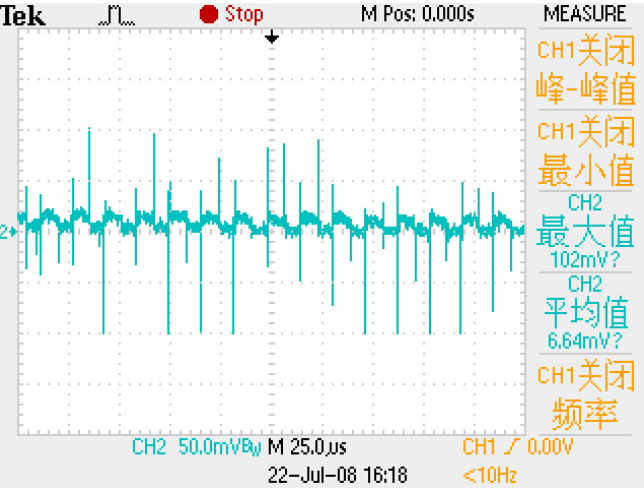
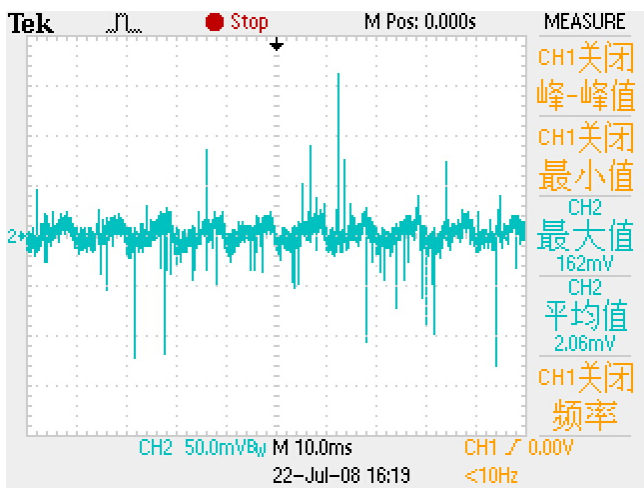

Output Ripple/Noise Test

Vin : 90Vac

O/P: +12V=3A

CH2 : VP-P+12V

Reading :162mV

Output Noise Test

Vin : 90Vac

O/P: +12V=2.5A

CH2 : VP-P+12V

Reading :102mV

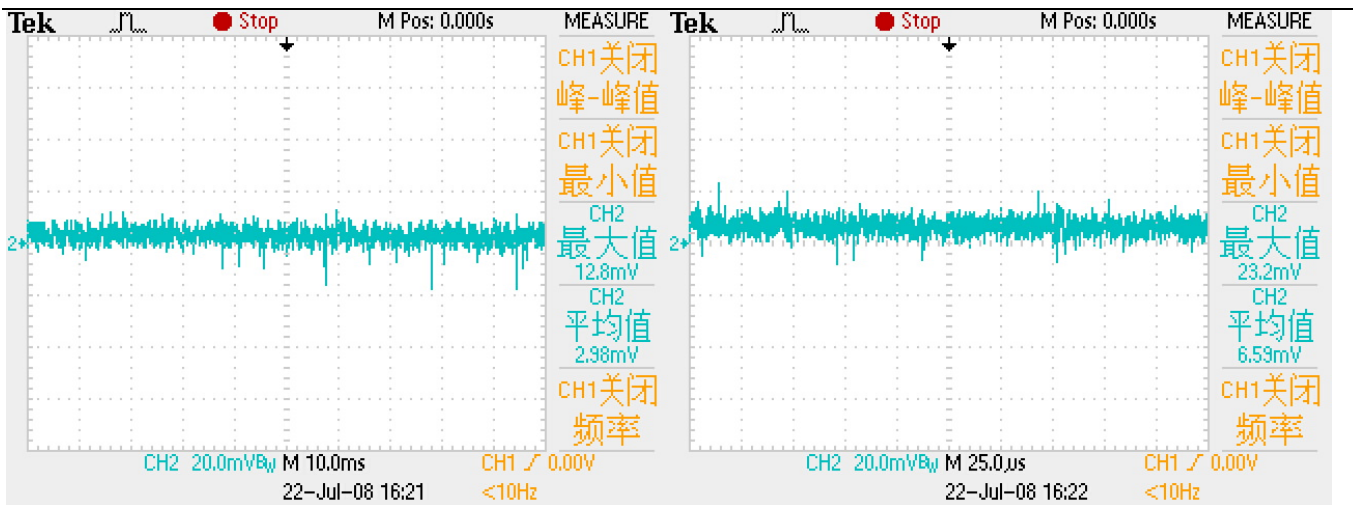

Output Ripple/Noise Test

Vin : 242Vac
 O/P: +12V=0A
 CH2 : VP-P+12V
 Reading : **12.8mV**

Output Noise Test

Vin : 242Vac
 O/P: +12V=0A
 CH2 : VP-P+12V
 Reading : **23.2mV**

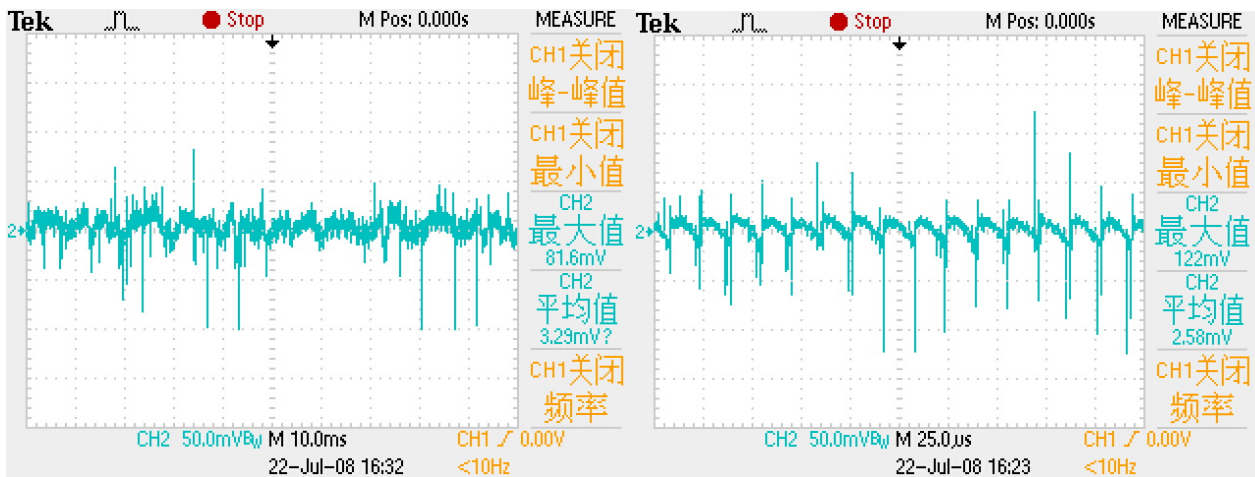

Output Ripple/Noise Test

Vin : 242Vac
 O/P: +12V=3A
 CH2 : VP-P+12V
 Reading : **81.6mV**

Output Noise Test

Vin : 242Vac
 O/P: +12V=3A
 CH2 : VP-P+12V
 Reading : **122mV**

9. Over Current Protection

The supply shall be designed with appropriate output over current protection. This protection shall be activated in the event of a short or long-term condition during which one or more of the output current load increases such that the primary current exceeds a predetermined limit. The primary shall limit the total power without inflicting any damage to any internal supply components and shall be reversible pending removal of the cause of the condition and without any user intervention.

Test Conditions:

Input: 90Vac/242Vac (60Hz)

Ambient Temperature : 25°C

Test Result : PASS

Input	Result (A)
90Vac	3.6
242Vac	3.4

10. Output Short Protection

The supply shall be designed with appropriate output short circuit protection. This protection shall be activated in the event of a short or long-term condition happened. The primary shall limit the total power without inflicting any damage to any internal supply components and shall be reversible pending removal of the cause of the condition and without any user intervention.

Test Conditions:

Input: 90Vac/242Vac (60Hz)

Ambient Temperature : 25°C

Test Result: PASS