

AC380V 电源线防雷方案:

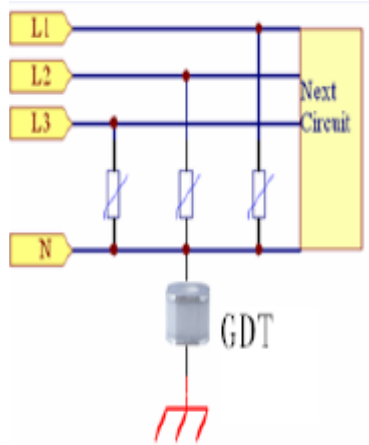

COMPONENT	DESCRIPTION	SUPPLIER NOTES
LT-14D561K	(504—616V) MOV	LangTuo
L8G800L	800V GDT 10KA (8/20μs)	LangTuo
IEC61000-4-5組合波 10KV		

AC220V 电源线防雷方案:

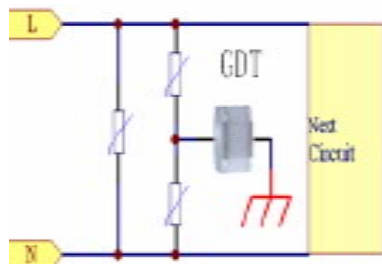

COMPONENT	DESCRIPTION	SUPPLIER NOTES
LT-14D561K	(504—616V) MOV	LangTuo
L5G600L	600V GDT 10KA (8/20μs)	LangTuo
IEC61000-4-5組合波 10KV		

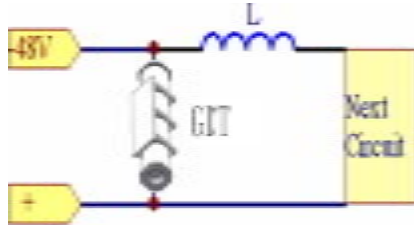

-48V 电源线防雷方案:

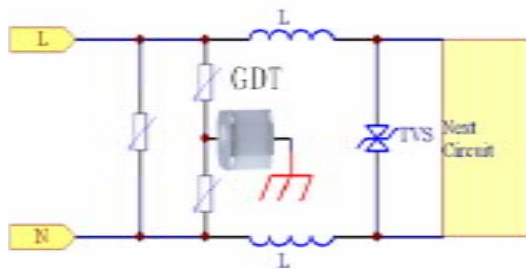

COMPONENT	DESCRIPTION	SUPPLIER NOTES
 LT-B5G090L	90V GDT	LangTuo
 BH601	无续流放电管 20KA (8/20μs)	LangTuo
IEC61000-4-5组合波 20KA		

AC24V 电源线防雷方案:



COMPONENT	DESCRIPTION	SUPPLIER NOTES
 LT-10D390K	(35V—43V) MOV	LangTuo
 LF071M	70V SMD-GDT	LangTuo
IEC61000-4-5组合波 10KV		

DC12V 电源线防雷方案:

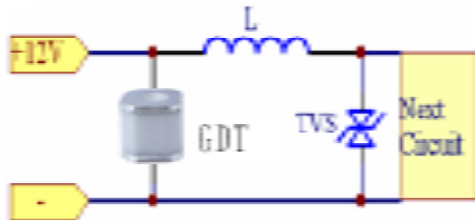

COMPONENT	DESCRIPTION	SUPPLIER NOTES
 LF091M	90V SMD-GDT	LangTuo
 PSMAJ15A	瞬变电压抑制器TVS	LangTuo
IEC61000-4-5组合波 3KA		

浪拓电子公司经过五年的快速发展，已经成为国内全方位提供防雷过压保护元器件制造商。经过多年的总结，建立起一套针对防雷保护的设计流程。