

1.0 Features

- Primary-side feedback eliminates opto-isolators and simplifies design
- 64-kHz PWM switching frequency
- No-load power consumption < 100 mW at 230 V_{ac} with tight dynamic load transient response
- Able to meet < 30 mW no-load power consumption with large value pre-load resistor
- Adaptive multi-mode PWM/PFM control improves efficiency
- Quasi-resonant operation for highest overall efficiency
- **EZ-EMI**[®] design to easily meet global EMI standards
- Direct drive of low-cost BJT switch
- Dynamic base current control
- Very tight constant voltage and constant current regulation with primary-side-only feedback
- No external compensation components required
- Complies with EPA 2.0 energy-efficiency specifications with ample margin
- Low start-up current (8 μA typical)
- Built-in soft start
- Built-in short circuit protection and output overvoltage protection
- Built-in current sense resistor short circuit protection
- No audible noise over entire operating range

2.0 Description

The iW1678 is a high performance AC/DC power supply controller which uses digital control technology to build peak current mode PWM flyback power supplies. The iW1678's 64-kHz PWM switching frequency allows the design of ultra-compact AC/DC adapters and chargers. The device directly drives a power BJT and operates in quasi-resonant mode to provide high efficiency along with a number of key built-in protection features while minimizing the external component count, simplifying EMI design and lowering the total bill of material cost. The iW1678 removes the need for secondary feedback circuitry while achieving excellent line and load regulation. It also eliminates the need for loop compensation components while maintaining stability over all operating conditions. Pulse-by-pulse waveform analysis allows for a loop response that is much faster than traditional solutions, resulting in improved dynamic load response. The built-in power limit function enables optimized transformer design in universal off-line applications and allows for a wide input voltage range.

iWatt's innovative proprietary technology ensures that power supplies built with iW1678 can achieve both highest average efficiency and less than 100 mW no-load power consumption in a compact form factor.

3.0 Applications

- Low power compact AC/DC adapter/chargers for cell phones, PDAs, digital still cameras
- Linear AC/DC replacement

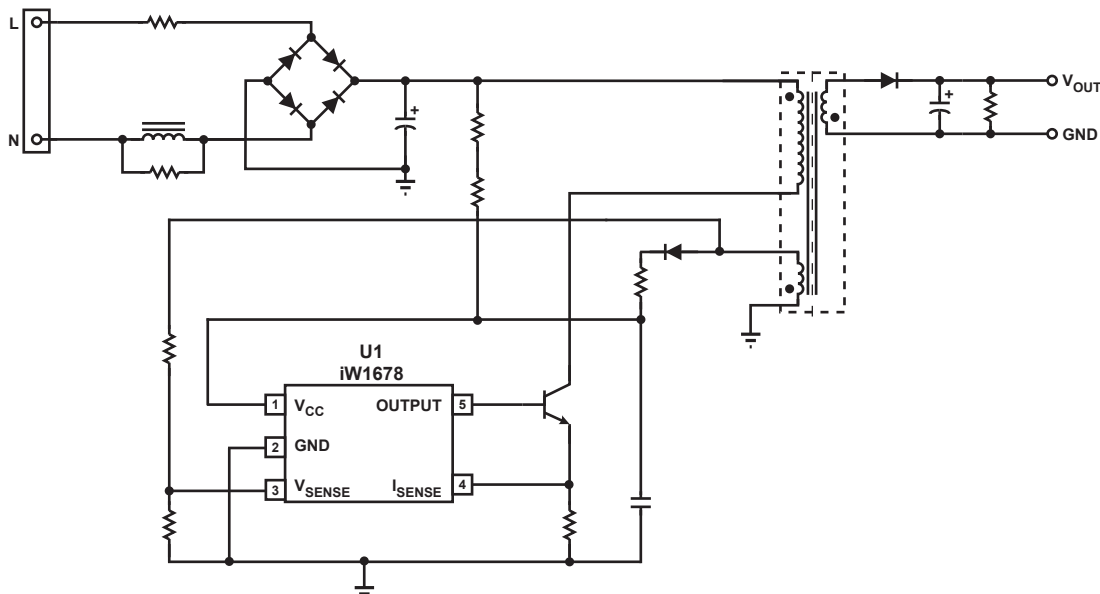

Figure 3.1: iW1678 Typical Application Circuit

4.0 Pinout Description

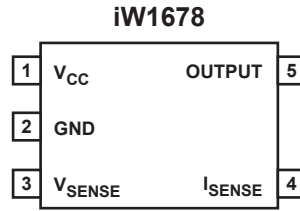

Figure 4.1: 5 Lead SOT-23 Package

Pin #	Name	Type	Pin Description
1	V_{CC}	Power Input	Power supply for control logic.
2	GND	Ground	Ground.
3	V_{SENSE}	Analog Input	Auxiliary voltage sense (used for primary regulation).
4	I_{SENSE}	Analog Input	Primary current sense. Used for cycle-by-cycle peak current control and limit.
5	OUTPUT	Output	Base drive for BJT.

5.0 Absolute Maximum Ratings

Absolute maximum ratings are the parameter values or ranges which can cause permanent damage if exceeded. For maximum safe operating conditions, refer to Electrical Characteristics in Section 6.0.

Parameter	Symbol	Value	Units
DC supply voltage range (pin 1, $I_{CC} = 20\text{mA max}$)	V_{CC}	-0.3 to 18	V
Continuous DC supply current at V_{CC} pin ($V_{CC} = 15\text{ V}$)	I_{CC}	20	mA
Output (pin 5)		-0.3 to 4.0	V
V_{SENSE} input (pin 3, $I_{V_{sense}} \leq 10\text{ mA}$)		-0.7 to 4.0	V
I_{SENSE} input (pin 4)		-0.3 to 4.0	V
Maximum junction temperature	$T_{J\text{ MAX}}$	125	°C
Storage temperature	T_{STG}	-65 to 150	°C
Lead temperature during IR reflow for ≤ 15 seconds	T_{LEAD}	260	°C
Thermal Resistance Junction-to-Ambient	θ_{JA}	190	°C/W
ESD rating per JEDEC JESD22-A114		2,000	V
Latch-Up test per JEDEC 78		± 100	mA

6.0 Electrical Characteristics $V_{CC} = 12\text{ V}, -40^{\circ}\text{C} \leq T_A \leq +85^{\circ}\text{C}$

Parameter	Symbol	Test Conditions	Min	Typ	Max	Unit
V_{SENSE} SECTION (Pin 3)						
Input leakage current	I_{BVS}	$V_{SENSE} = 2\text{ V}$			1	μA
Nominal voltage threshold	$V_{SENSE(NOM)}$	$T_A = 25^{\circ}\text{C}$, negative edge	1.523	1.538	1.553	V
Output OVP threshold -00	$V_{SENSE(MAX)}$	$T_A = 25^{\circ}\text{C}$, negative edge		1.834		V
Output OVP threshold -01	$V_{SENSE(MAX)}$	$T_A = 25^{\circ}\text{C}$, negative edge Load = 100 %		1.926		V
Output OVP threshold -03	$V_{SENSE(MAX)}$	$T_A = 25^{\circ}\text{C}$, negative edge Load = 100 %		1.972		V
Output OVP threshold -05	$V_{SENSE(MAX)}$	$T_A = 25^{\circ}\text{C}$, negative edge Load = 100 %		1.880		V
I_{SENSE} SECTION (Pin 4)						
Overcurrent threshold	V_{OCP}			1.1	1.15	V
I _{SENSE} regulation upper limit (Note 1)	$V_{IPK(HIGH)}$			1.0		V
I _{SENSE} regulation lower limit (Note 1)	$V_{IPK(LOW)}$			0.25		V
Input leakage current	I_{LK}	$I_{SENSE} = 1.0\text{ V}$			1	μA
OUTPUT SECTION (Pin 5)						
Output low level ON-resistance	$R_{DS(ON)LO}$	$I_{SINK} = 5\text{ mA}$		3	6	Ω
PWM switching frequency (Note 2)	f_{SW}	> 50% load		64		kHz
V_{CC} SECTION (Pin 1)						
Maximum operating voltage (Note 1)	$V_{CC(MAX)}$				16	V
Start-up threshold	$V_{CC(ST)}$	V_{CC} rising	9.5	10.5	11.5	V
Undervoltage lockout threshold	$V_{CC(UVL)}$	V_{CC} falling	3.9	4.1	4.3	V
Start-up current	$I_{IN(ST)}$	$V_{CC} = 10\text{ V}$		8	15	μA
Quiescent current	I_{CCQ}	No I_b current		2.5	3.5	mA
Zener breakdown voltage	V_{ZB}	Zener current = 1 mA $T_A = 25^{\circ}\text{C}$	18	19	20.5	V

Notes:

Note 1. These parameters are not 100% tested, guaranteed by design and characterization.

Note 2. Operating frequency varies based on the load conditions, see section 9.6 for more details.

7.0 Typical Performance Characteristics

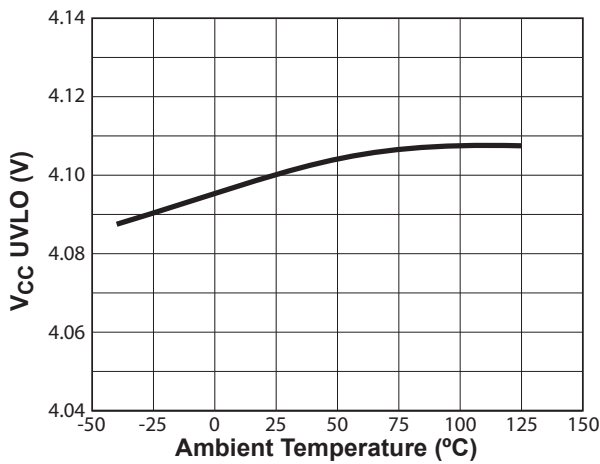

Figure 7.1 : V_{CC} UVLO vs. Temperature

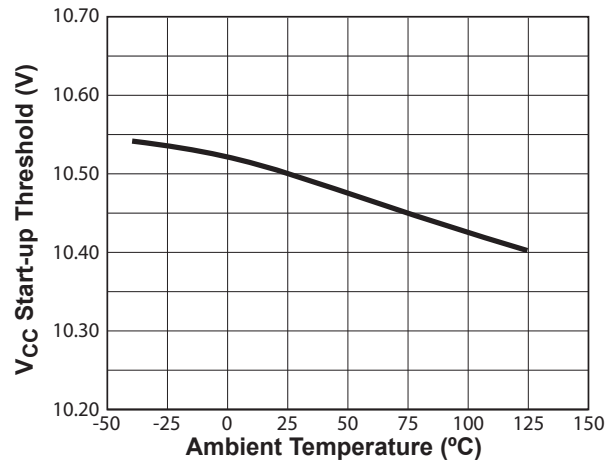

Figure 7.2 : Start-Up Threshold vs. Temperature

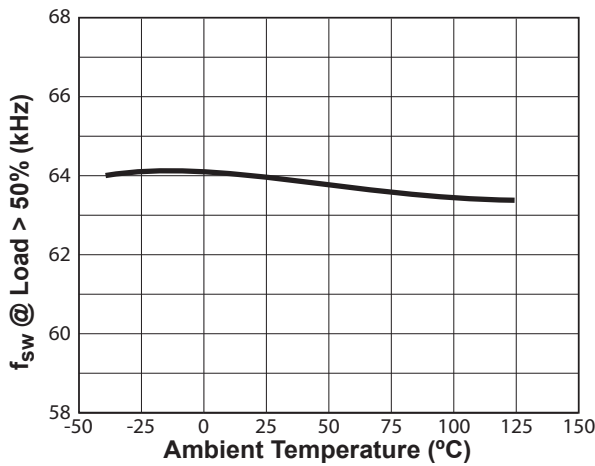

Figure 7.3 : Switching Frequency vs. Temperature¹

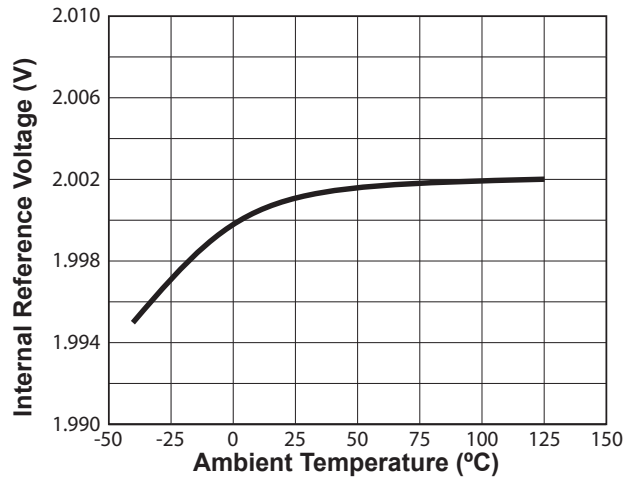

Figure 7.4 : Internal Reference vs. Temperature

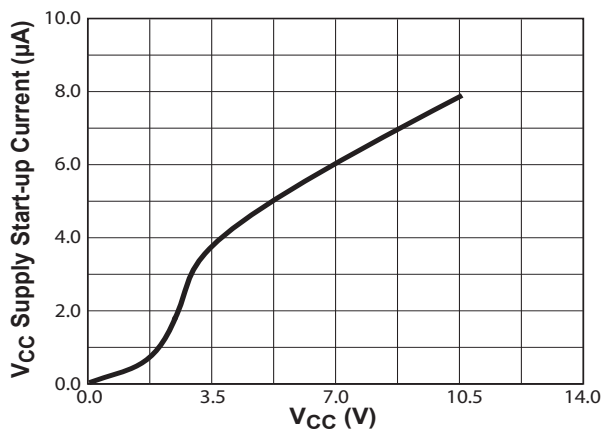

Figure 7.5 : V_{CC} vs. V_{CC} Supply Start-up Current

Notes:

Note 1. Operating frequency varies based on the load conditions, see section 9.6 for more details.

8.0 Functional Block Diagram

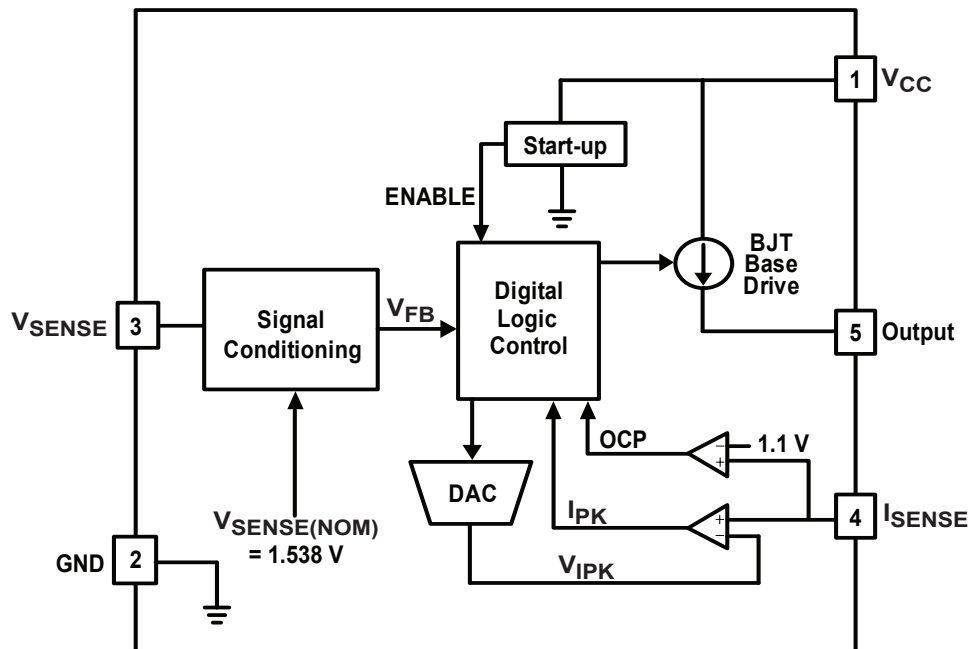

Figure 8.1: iW1678 Functional Block Diagram

9.0 Theory of Operation

The iW1678 is a digital controller which uses a new, proprietary primary-side control technology to eliminate the opto-isolated feedback and secondary regulation circuits required in traditional designs. This results in a low-cost solution for low power AC/DC adapters. The core PWM processor uses fixed-frequency Discontinuous Conduction Mode (DCM) operation at higher power levels and switches to variable frequency operation at light loads to maximize efficiency. Furthermore, iWatt's digital control technology enables fast dynamic response, tight output regulation, and full featured circuit protection with primary-side control.

Referring to the block diagram in Figure 8.1, the digital logic control block generates the switching on-time and off-time information based on the output voltage and current feedback signal and provides commands to dynamically control the external BJT base current. The system loop is automatically compensated internally by a digital error amplifier. Adequate system phase margin and gain margin are guaranteed by design and no external analog components are required for loop compensation. The iW1678 uses an advanced digital control algorithm to reduce system design time and increase reliability.

Furthermore, accurate secondary constant-current operation is achieved without the need for any secondary-side sense and control circuits.

The iW1678 uses adaptive multi-mode PWM/PFM control to dynamically change the BJT switching frequency for efficiency, EMI, and power consumption optimization. In addition, it achieves unique BJT quasi-resonant switching to further improve efficiency and reduce EMI. Built-in protection features include overvoltage protection (OVP), output short circuit protection (SCP), over current protection (OCP), single point fault protection and I_{SENSE} fault detection.

iWatt's digital control scheme is specifically designed to address the challenges and trade-offs of power conversion design. This innovative technology is ideal for balancing new regulatory requirements for green mode operation with more practical design considerations such as lowest possible cost, smallest size and high performance output control.

9.1 Pin Detail

Pin 1 – V_{CC}

Power supply for the controller during normal operation. The controller will start up when V_{CC} reaches 10.5 V (typical) and will shut-down when the V_{CC} voltage is 4.1 V (typical). A decoupling capacitor should be connected between the V_{CC} pin and GND.

Pin 2 – GND

Ground.

Pin 3 – V_{SENSE}

Sense signal input from auxiliary winding. This provides the secondary voltage feedback used for output regulation.

Pin 4 – I_{SENSE}

Primary current sense. Used for cycle-by-cycle peak current control and limit.

Pin 5 – OUTPUT

Base drive for the external power BJT switch.

9.2 Start-up

Prior to start-up, the V_{CC} pin is charged typically through start-up resistors. When V_{CC} bypass capacitor is fully charged to a voltage higher than the start-up threshold V_{CC(ST)}, the ENABLE signal becomes active to enable the control logic, and the iW1678 commences soft start function. An adaptive soft-start control algorithm is applied at startup state, during which the initial output pulses will be small and gradually get larger until the full pulse width is achieved. The peak current is limited cycle by cycle by the I_{PEAK} comparator.

If at any time the V_{CC} voltage drops below V_{CC(UVL)} threshold then all the digital logic is reset. At this time ENABLE signal becomes low and the V_{CC} capacitor is charged up again towards the start-up threshold.

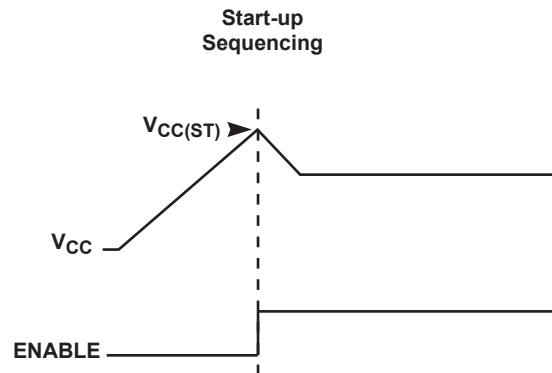

Figure 9.1: Start-up Sequencing Diagram

9.3 Understanding Primary Feedback

Figure 9.2 illustrates a simplified flyback converter. When the switch Q1 conducts during t_{ON}(t), the current i_g(t) is directly drawn from rectified sinusoid v_g(t). The energy E_g(t) is stored in the magnetizing inductance L_M. The rectifying diode D1 is reverse biased and the load current I_O is supplied by the secondary capacitor C_O. When Q1 turns off, D1 conducts and the stored energy E_g(t) is delivered to the output.

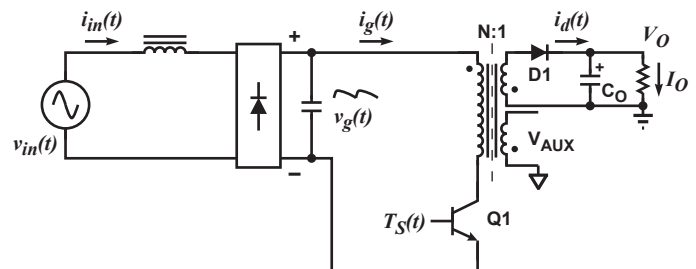

Figure 9.2: Simplified Flyback Converter

In order to tightly regulate the output voltage, the information about the output voltage and load current need to be accurately sensed. In the DCM flyback converter, this information can be read via the auxiliary winding or the primary magnetizing inductance (L_M). During the Q1 on-time, the load current is supplied from the output filter capacitor C_O. The voltage across L_M is v_g(t), assuming the voltage dropped across Q1 is zero. The current in Q1 ramps up linearly at a rate of:

$$\frac{di_g(t)}{dt} = \frac{v_g(t)}{L_M} \quad (9.1)$$

At the end of on-time, the current has ramped up to:

$$i_{g_peak}(t) = \frac{v_g(t) \times t_{ON}}{L_M} \quad (9.2)$$

This current represents a stored energy of:

$$E_g = \frac{L_M}{2} \times i_{g_peak}^2(t) \quad (9.3)$$

When Q1, turns off at t_o , $i_g(t)$ in L_M forces a reversal of polarities on all windings. Ignoring the commutation-time caused by the leakage inductance L_k at the instant of turn-off t_o , the primary current transfers to the secondary at a peak amplitude of:

$$i_d(t) = \frac{N_P}{N_S} \times i_{g_peak}(t) \quad (9.4)$$

Assuming the secondary winding is master, and the auxiliary winding is slave,

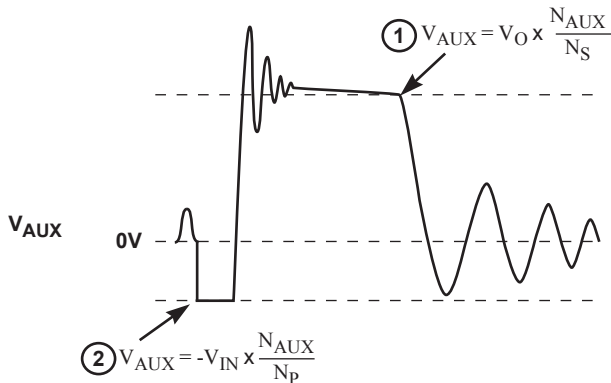

Figure 9.3: Auxiliary Voltage Waveforms

The auxiliary voltage is given by:

$$V_{AUX} = \frac{N_{AUX}}{N_S} (V_O + \Delta V) \quad (9.5)$$

and reflects the output voltage as shown in Figure 9.3.

The voltage at the load differs from the secondary voltage by a diode drop and IR losses. Thus, if the secondary voltage is always read at a constant secondary current, the difference between the output voltage and the secondary voltage will be a fixed ΔV . Furthermore, if the voltage can be read when the secondary current is small, ΔV will also be small. With the iW1678, ΔV can be ignored.

The real-time waveform analyzer in the iW1678 reads this information cycle by cycle. The part then generates a

feedback voltage V_{FB} . The V_{FB} signal precisely represents the output voltage under most conditions and is used to regulate the output voltage.

9.4 Constant Voltage Operation

After soft-start has been completed, the digital control block measures the output conditions. It determines output power levels and adjusts the control system according to a light load or heavy load. If this is in the normal range, the device operates in the Constant Voltage (CV) mode, and changes the pulse width (T_{ON}) and off time (T_{OFF}) in order to meet the output voltage regulation requirements.

If no voltage is detected on V_{SENSE} it is assumed that the auxiliary winding of the transformer is either open or shorted and the iW1678 shuts down.

9.5 Constant Current Operation

The constant current (CC mode) is useful in battery charging applications. During this mode of operation the iW1678 will regulate the output current at a constant level regardless of the output voltage, while avoiding continuous conduction mode.

To achieve this regulation the iW1678 senses the load current indirectly through the primary current. The primary current is detected by the I_{SENSE} pin through a resistor from the BJT emitter to ground.

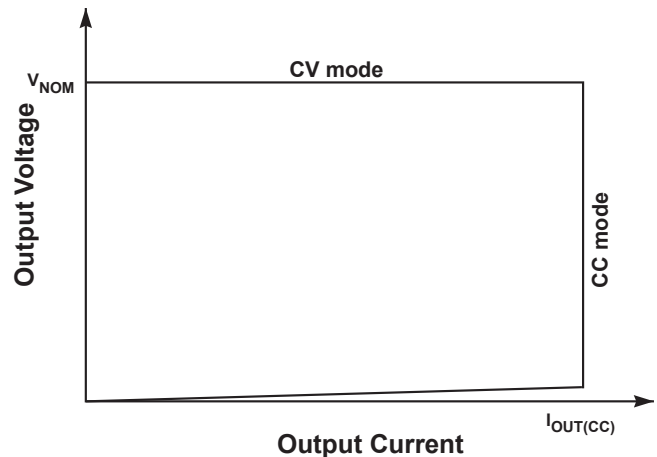

Figure 9.4: Power Envelope

9.6 Multi-Mode PWM/PFM Control and Quasi-Resonant Switching

The iW1678 uses a proprietary adaptive multi-mode PWM / PFM control to dramatically improve the light-load efficiency and thus the overall average efficiency.

During the constant voltage (CV) operation, the iW1678 normally operates in a pulse-width-modulation (PWM) mode during heavy load conditions. In the PWM mode, the switching frequency keeps around constant. As the output load I_{OUT} is reduced, the on-time t_{ON} is decreased, and the controller adaptively transitions to a pulse-frequency-modulation (PFM) mode. During the PFM mode, the BJT is turned on for a set duration under a given instantaneous rectified AC input voltage, but its off time is modulated by the load current. With a decreasing load current, the off time increases and thus the switching frequency decreases.

As the load current is further reduced, the iW1678 transitions to a deep PFM mode (DPFM) which reduces the switching frequency to a very low level.

While operating in the adaptive multi-mode PWM/PFM control, iW1678 also incorporates a unique quasi-resonant switching in both CV and CC operations. Together these innovative digital control architecture and algorithms enable iW1678 to achieve highest overall efficiency and lowest EMI.

9.7 Variable Frequency Operation Mode

At each of the switching cycles, the falling edge of V_{SENSE} will be checked. If the falling edge of V_{SENSE} is not detected, the off-time will be extended until the falling edge of V_{SENSE} is detected. The maximum allowed transformer reset time is 75 μ s. When the transformer reset time reaches 75 μ s, the iW1678 shuts off.

9.8 Internal Loop Compensation

The iW1678 incorporates an internal Digital Error Amplifier with no requirement for external loop compensation. For a typical power supply design, the loop stability is guaranteed to provide at least 45 degrees of phase margin and -20 dB of gain margin.

9.9 Voltage Protection Features

The secondary maximum output DC voltage is limited by the iW1678. When the V_{SENSE} signal exceeds the output OVP

threshold at point 1 indicated in figure 9.3 the iW1678 shuts down.

The iW1678 protects against input line undervoltage by setting a maximum T_{ON} time. Since output power is proportional to the squared $V_{IN}T_{ON}$ product then for a given output power as V_{IN} decreases the T_{ON} will increase. Thus by knowing when the maximum T_{ON} time occurs the iW1678 detects that the minimum V_{IN} is reached, and shuts down. The maximum t_{ON} limit is set to 15 μ s. Also, the iW1678 monitors the voltage on the V_{CC} pin and when the voltage on this pin is below UVLO threshold the IC shuts down immediately.

When any of these faults are met the IC remains biased to discharge the V_{CC} supply. Once V_{CC} drops below UVLO threshold, the controller resets itself and then initiates a new soft-start cycle. The controller continues attempting start-up until the fault condition is removed.

9.10 PCL, OCP and SRS Protection

Peak-current limit (PCL), over-current protection (OCP) and sense-resistor short protection (SRSP) are features built-in to the iW1678. With the I_{SENSE} pin the iW1678 is able to monitor the peak primary current. This allows for cycle by cycle peak current control and limit. When the primary peak current multiplied by the I_{SENSE} resistor is greater than 1.1 V over current (OCP) is detected and the IC will immediately turn off the base driver until the next cycle. The output driver will send out a switching pulse in the next cycle, and the switching pulse will continue if the OCP threshold is not reached; or, the switching pulse will turn off again if the OCP threshold is reached. If the OCP occurs for several consecutive switching cycles, the iW1678 shuts down.

If the I_{SENSE} resistor is shorted there is a potential danger of the over current condition not being detected. Thus, the IC is designed to detect this sense-resistor-short fault after startup and shut down immediately. The V_{CC} will be discharged since the IC remains biased. Once V_{CC} drops below the UVLO threshold, the controller resets itself and then initiates a new soft-start cycle. The controller continues attempting to startup, but does not fully startup until the fault condition is removed.

9.11 Dynamic Base Current Control

One important feature of the iW1678 is that it directly drives a BJT switching device with dynamic base current control to optimize performance. The BJT base current ranges from 10 mA to 31 mA, and is dynamically controlled according to

the power supply load change. The higher the output power, the higher the base current. Specifically, the base current is related to V_{IPK} , as shown in Figure 9.5.

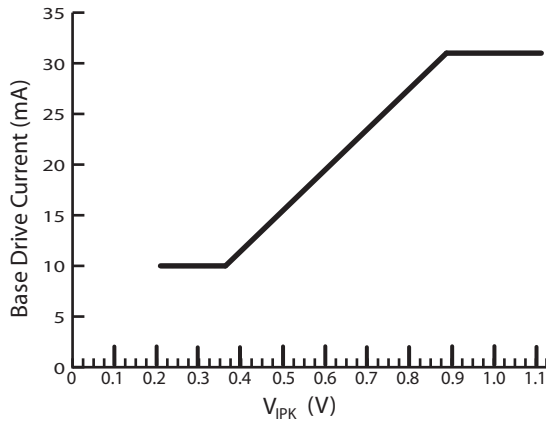

Figure 9.5: Base Drive Current vs. V_{IPK}

9.12 Cable Drop Compensation

The iW1678 incorporates an innovative method to compensate for any IR drop in the secondary circuitry including cable and cable connector. A 2.5 W adapter with 5 V DC output has 3% deviation at 0.5 A load current due to the drop across a 24 AWG, 1.8 meter DC cable without cable compensation. The iW1678 compensates for this voltage drop by providing a voltage offset to the feedback signal based on the amount of load current detected.

To calculate the amount of cable compensation needed, take the resistance of the cable and connector and multiply by the maximum output current.

10.0 Physical Dimensions

5-Lead SOT Package

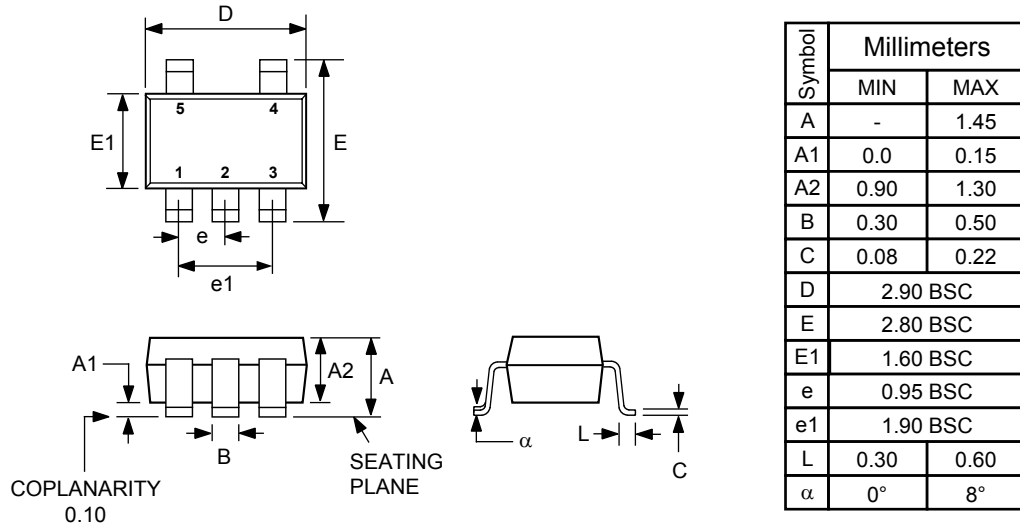

Figure 10.1: Physical dimensions, 5-lead SOT-23 package

Compliant to JEDEC Standard MO178

Controlling dimensions are in millimeters

This package is RoHS compliant, and conform to Halide free limits.

Soldering Temperature Resistance:

- [a] Package is IPC/JEDEC Std 020D Moisture Sensitivity Level 1
- [b] Package exceeds JEDEC Std No. 22-A111 for Solder Immersion resistance; packages can withstand 10 s immersion @ < 270 °C

Dimension D does not include mold flash, protrusions or gate burrs. Mold flash, protrusions or gate burrs shall not exceed 0.25 mm per end. Dimension E1 does not include interlead flash or protrusion. Interlead flash or protrusion shall not exceed 0.25 mm per side. D and E1 dimensions are determined at datum H.

The package top may be smaller than the package bottom. Dimension D and E1 are determined at the outermost extremes of the plastic body exclusive of mold flash, tie bar burrs, gate burrs and interlead flash, but including any mismatch between the top and bottom of the plastic body. D and E1 dimensions are determined at datum H.

11.0 Ordering Information

Part Number	Options	Package	Description
iW1678-00	Cable Comp = 0 mV	SOT-23	Tape & Reel ¹
iW1678-01	Cable Comp = 300 mV	SOT-23	Tape & Reel ¹
iW1678-03	Cable Comp = 450 mV	SOT-23	Tape & Reel ¹
iW1678-05	Cable Comp = 150 mV	SOT-23	Tape & Reel ¹

Note 1: Tape & Reel packing quantity is 3,000 per reel. Minimum ordering quantity is 3,000.

iW1678

Low-Power Off-line Digital Green-Mode PWM Controller



About iWatt

iWatt Inc. is a fabless semiconductor company that develops intelligent power management ICs for computer, communication, and consumer markets. The company's patented *pulseTrain*™ technology, the industry's first truly digital approach to power system regulation, is revolutionizing power supply design.

Trademark Information

© 2008 iWatt, Inc. All rights reserved. iWatt, the iW light bulb, *EZ-EMI* and *pulseTrain* are trademarks of iWatt, Inc. All other trademarks and registered trademarks are the property of their respective companies.

Contact Information

Web: <http://www.iwatt.com>

E-mail: info@iwatt.com

Phone: 408-374-4200

Fax: 408-341-0455

iWatt Inc.

101 Albright Way
Los Gatos CA 95032-1827

Disclaimer

iWatt reserves the right to make changes to its products and to discontinue products without notice. The applications information, schematic diagrams, and other reference information included herein is provided as a design aid only and are therefore provided as-is. iWatt makes no warranties with respect to this information and disclaims any implied warranties of merchantability or non-infringement of third-party intellectual property rights.

Certain applications using semiconductor products may involve potential risks of death, personal injury, or severe property or environmental damage ("Critical Applications").

IWATT SEMICONDUCTOR PRODUCTS ARE NOT DESIGNED, INTENDED, AUTHORIZED, OR WARRANTED TO BE SUITABLE FOR USE IN LIFE-SUPPORT APPLICATIONS, DEVICES OR SYSTEMS, OR OTHER CRITICAL APPLICATIONS.

Inclusion of iWatt products in critical applications is understood to be fully at the risk of the customer. Questions concerning potential risk applications should be directed to iWatt, Inc.

iWatt semiconductors are typically used in power supplies in which high voltages are present during operation. High-voltage safety precautions should be observed in design and operation to minimize the chance of injury.