

电子元件专业交流平台，专业MARKINGCODE交流平台，诚邀你的参与：

<http://tieba.baidu.com/club/10468944>

承接各类贴片丝印查询，需要的话联系

联系人：曾先生 13662236349 QQ:372613373

[Http://www.kssdz.com.cn](http://www.kssdz.com.cn)

# THE SMD CODEBOOK

## SMD Codes.

SMD devices are, by their very nature, too small to carry conventional semiconductor type numbers. Instead, a somewhat arbitrary coding system has grown up, where the device package carries a simple two- or three-character ID code.

Identifying the manufacturers' type number of an SMD device from the package code can be a difficult task, involving combing through many different databooks.

This HTML book is designed to provide an easy means of device identification. It lists well over 3,400 device codes in alphabetical order, together with type numbers, device characteristics or equivalents and pinout information.

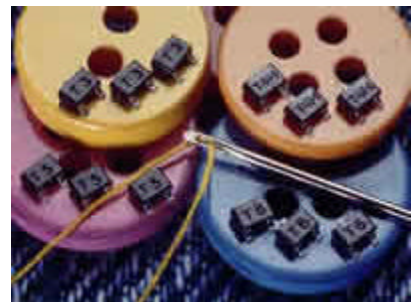

### How to use the SMD Codebook

To identify a particular SMD device, first identify the package style and note the ID code printed on the device. Now look up the code in the alphanumeric listing which forms the main part of this book by clicking on the first character shown in the left-menu.

Unfortunately, each device code is not necessarily unique. For example a device coded **1A** might be either a **BC846A** or a **FMMT3904**. Even the same manufacturer may use the same code for different devices!

If there is more than one entry, use the package style to differentiate between devices with the same ID code.

This compilation has been collected from R P Blackwell G4PMK, manufacturers' data and other sources of SMD device ID codes, pinout and leaded device equivalent information.

The entries under the Manufacturer column are not intended to be comprehensive; rather they are intended to provide help on locating sources of more detailed information if you require it.

### ID Code Variations

Many manufacturers use an extra letter as their own identification code. If the device is from Philips it will sometimes have a lower case 'p' (or sometimes 't') added to the code; Siemens devices usually have a lower case 's'.

For example, if the code is **1A**, according to the table there are a number of possibilities:

- 1A BC846A Phi ITT N BC546A
- 1A FMMT3904 Zet N 2N3904
- 1A MMBT3904 Mot N 2N3904
- 1A IRLML2402 IR F n-ch mosfet 20V 0.9A

**This has been a problem in the past, however recently manufacturers have been adding lower case letters which clarify the code.**

Many recent Motorola devices have a small superscript letter after the device code, such as **SA<sup>C</sup>**. (This smaller letter is merely a month of manufacture code.)

Many devices from Rohm Semiconductors which start with **G** have direct equivalents found in the rest of the number. For example **GD1** is the same as **D1** which is a BCW31.

Some devices have a single coloured letter (usually on extremely small diode packages). Colour, if significant, is shown in small type after the code letter.

An 'L' suffix usually indicates a low-profile package, such as an SOT323 or SC70.



SOT323.



SC70.

Reverse joggle devices do present a few problems. They often have an 'R' in the type number. A reverse package is one where the lead have been bent up instead of down. So it's a mirror image of a conventional device. Identification is usually possible from the code number, but some manufacturers use the same code. In these cases, it's a case of looking at the device with a magnifying glass. The leads of most normal packages come out closer to the circuit board side of the device; conversely a reverse joggle package will have them coming out closer to the 'top' of the device.

Sometimes a series of devices, derived from the same die, have related type (not code) numbers. Often an 'R' will indicate a reverse joggle package, and/or a 'W' indicate a smaller package variant, such as SOT343.

Sometimes similarities are also found in the code numbers. For example:

Recently some manufacturers have used a symbol or lower case letter to indicate the country of manufacture. These have been ignored in the alphabetical ordering. For example:

- '67' is the code for a BFP67 (SOT143 package) ,
- '67R' is the code for the reverse joggle variant BFP67R (SOT143R),
- 'W67' is the code for a SOT343 package version.



SOT143.

'Z-S' and 'ZtS' are both 2PC4081Q devices made by Philips; the first made in Hong Kong and the second in Malaysia; this appears in the codebook classified under **ZS**.

#### Leaded equivalent device and information

Where possible, the listing gives the part number of a conventional wire-leaded device with equivalent characteristics. If the leaded device is well-known then no more information is given. If the device is less common, some additional information will sometimes be given. Where no exact leaded equivalent exists, a brief device description is given, which may be sufficient to allow substitution with another device.

When describing device characteristics, some terms are implied from the type of device. For example, a voltage specified for a rectifier diode is usually the maximum PIV (peak inverse voltage) of the diode, but for a zener diode the operating (zener voltage) will be given.

Normally, where a voltage, current or power is specified, these will be limiting values. For example, a device specified as NPN 20V 0.1A 1W is a NPN transistor with a  $V_{ce}$  (max) of 20V, maximum collector current of 100mA and a maximum total power dissipation of 1W. Some of the transistors are types with integrated resistors; in the list, a base resistor means a resistor connected in series with the base. When two resistor values are given, the first is the series base resistor, and the second the resistor between base and emitter.

#### Digital Transistors (dtr)

These are transistors with built-in resistors.

Some have one resistor between base and emitter, others in series with the base. Many others have both.

To keep things simple, the series resistor is called R1 and the base emitter resistor is called R2. If both are present, then two values are given, R1 first. So 4k7 + 10k means that R1 (the base resistor) is 4k7 and R2 (the resistor between base and emitter) is 10k.

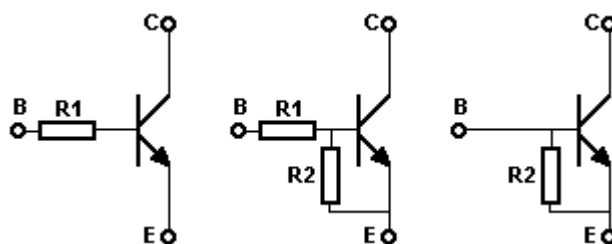

#### Conclusion

Identifying the manufacturers' type number of an SMD device from the package code can be a difficult task, involving combing through many different databooks. This HTML book is designed to provide an easy means of device identification.

## Abbreviations

<b>amp</b>	amplifier
<b>atten</b>	attenuator
<b>a</b>	anode
<b>b</b>	base
<b>c</b>	cathode
<b>ca</b>	common anode
<b>cc</b>	common cathode
<b>comp</b>	complement
<b>d</b>	drain
<b>dg</b>	dual gate
<b>dtr</b>	digital transistor (see codebook introduction)
<b>enh</b>	enhancement (mode - FETs)
<b>fet</b>	field effect transistor
<b>fT</b>	transition frequency
<b>GaAsfet</b>	Gallium Arsenide field effect transistor
<b>g</b>	gate
<b>gnd</b>	ground
<b>gp</b>	general purpose
<b>hfe</b>	small signal current gain
<b>i/p</b>	input
<b>Id</b>	drain current
<b>Ig</b>	gate current
<b>Ir</b>	reverse leakage current (diodes)

<b>jfet</b>	junction field effect transistor
<b>MAG</b>	maximum available gain
<b>max</b>	maximum
<b>min</b>	minimum
<b>mmic</b>	microwave minature integrated circuit
<b>modamp</b>	modular amplifier - an mmic amplifier
<b>mosfet</b>	metal oxide insulated gate fet
<b>n-ch</b>	n-channel fet (any type)
<b>npn</b>	npn bipolar transistor
<b>o/p</b>	output
<b>p-ch</b>	p-channel fet (any type)
<b>pin</b>	pin diode
<b>pkg</b>	package
<b>pnp</b>	pnp bipolar transistor
<b>prot</b>	protection, protected (as in mosfet gate)
<b>res</b>	resistor
<b>s</b>	source
<b>ser</b>	series
<b>Si</b>	silicon
<b>substr</b>	substrate
<b>sw</b>	switch or switching
<b>Vce</b>	collector - emitter voltage (maximum)
<b>Vcc</b>	collector supply voltage

#### **Manufacturer abbreviations**

<b>Agi</b>	Agilent (was HP)
<b>Fch</b>	Fairchild
<b>HP</b>	Hewlett-Packard (Now Agilent)
<b>Inf</b>	Infineon (was Siemens)
<b>ITT</b>	ITT Semiconductors
<b>MC</b>	Mini-Circuits
<b>Mot</b>	Motorola (now ON Semiconductors)
<b>Nat</b>	National Semiconductor
<b>Nec</b>	NEC
<b>NJRC</b>	New Japan Radio Co
<b>ON</b>	ON Semiconductors (was Motorola)
<b>Phi</b>	Philips
<b>Roh</b>	Rohm
<b>SGS</b>	SGS-Thompson
<b>Sie</b>	Siemens (now Infineon)
<b>Sil</b>	Siliconix (Vishay-Siliconix)
<b>Tem</b>	Temic Semiconductors
<b>Tfk</b>	Telefunken (Vishay-Telefunken)
<b>Tok</b>	Toko Inc.
<b>Zet</b>	Zetex

### Codes beginning with '0'

Code	Device	Manufacturer	Base	Package	Leaded Equivalent/Data
0	2SC3603	Nec	CX	SOT173	Npn RF fT 7GHz
005	SSTPAD5	Sil	J	-	PAD-5 5pA leakage diode
p01	PDTA143ET	Phi	N	SOT23	pnp dtr 4k7+4k7
t01	PDTA143ET	Phi	N	SOT23	pnp dtr 4k7+4k7
01	Gali-1	MC	AZ	SOT89	DC-8GHz MMIC amp 12dB gain
010	SSTPAD10	Sil	J	-	PAD-10 10pA leakage diode
011	SO2369R	SGS	R	SOT23R	2N2369
02	BST82	Phi	M	-	n-ch mosfet 80V 175mA
02	MRF5711L	Mot	X	SOT143	npn RF MRF571
02	DTCC114T	Roh	N	-	50V 100mA npn sw + 10k base res
02	Gali-2	MC	AZ	SOT89	DC-8GHz MMIC amp 16dB gain
p02	PDTC143ET	Phi	N	SOT23	npn 4k7+4k7 bias res
t02	PDTC143ET	Phi	N	SOT23	npn 4k7+4k7 bias res
03	Gali-3	MC	AZ	SOT89	DC-3GHz MMIC amp 22dB gain
03	DTC143TE	Roh	N	EMT3	npn dtr R1 4k7 50V 100mA
03	DTC143TUA	Roh	N	SC70	npn dtr R1 4k7 50V 100mA
03	DTC143TKA	Roh	N	SC59	npn dtr R1 4k7 50V 100mA
04	DTC114TCA	Roh	N	SOT23	npn dtr R1 10k 50V 100mA
04	DTC114TE	Roh	N	EMT3	npn dtr R1 10k 50V 100mA
04	DTC114TUA	Roh	N	SC70	npn dtr R1 10k 50V 100mA
04	DTC114TKA	Roh	N	SC59	npn dtr R1 10k 50V 100mA
04	MRF5211L	Mot	X	SOT143	pnnp RF MRF521
04	Gali-4	MC	AZ	SOT89	DC-4GHz MMIC amp 17.5 dBm
-04	PMSS3904	Phi	N	SOT323	2N3904

t04	PMBS3904	Phi	N	SOT23	2N3904
05	Gali-4	MC	AZ	SOT89	DC-4GHz MMIC amp 18 dBm o/p
05	DTC124TE	Roh	N	EMT3	npn dtr R1 22k 50V 100mA
05	DTC124TUA	Roh	N	SC70	npn dtr R1 22k 50V 100mA
05	DTC124TKA	Roh	N	SC59	npn dtr R1 22k 50V 100mA
05F	TSDF1205R	Tfk	WQ	-	ft12GHz npn 4V 5mA
06	Gali-6	MC	AZ	SOT89	DC-4GHz MMIC amp 115 dBm o/p
06	DTC144TE	Roh	N	EMT3	npn dtr R1 47k 50V 100mA
06	DTC144TUA	Roh	N	SC70	npn dtr R1 47k 50V 100mA
06	DTC144TKA	Roh	N	SC59	npn dtr R1 47k 50V 100mA
-06	PMSS3906	Phi	N	SOT323	2N3906
t06	PMBS3906	Phi	N	SOT23	2N3906
020	SSTPAD20	Sil	J	-	PAD-20 20pA leakage diode
050	SSTPAD50	Sil	J	-	PAD-50 50pA leakage diode
081	SO2369AR	SGS	R	SOT23R	2N2369A
09	DTC115TUA	Roh	N	SC70	npn dtr R2 100k 50V 100mA
09	DTC115TKA	Roh	N	SC59	npn dtr R2 100k 50V 100mA
0A	MUN5111DW1	Mot	DO	SOT363	dual pnp dtr 10k+10k
0A	DTC125TUA	Roh	N	SC70	npn dtr R2 100k 50V 100mA
0A	DTC125TKA	Roh	N	SC59	npn dtr R2 100k 50V 100mA
0B	MUN5112DW1	Mot	DO	SOT363	dual pnp dtr 22k+22k
0C	MUN5113DW1	Mot	DO	SOT363	dual pnp dtr 47k+47k
0D	MUN5114DW1	Mot	DO	SOT363	dual pnp dtr 10k+47k
0E	MUN5115DW1	Mot	DO	SOT363	dual pnp dtr R1 10k
0F	MUN5116DW1	Mot	DO	SOT363	dual pnp dtr R1 4k7
0G	MUN5130DW1	Mot	DO	SOT363	dual pnp dtr 1k0+1k0
0H	MUN5131DW1	Mot	DO	SOT363	dual pnp dtr 2k2+2k2
0J	MUN5132DW1	Mot	DO	SOT363	dual pnp dtr 4k7+4k7
0K	MUN5133DW1	Mot	DO	SOT363	dual pnp dtr 4k7+47k
0L	MUN5134DW1	Mot	DO	SOT363	dual pnp dtr 22k+47k
0M	MUN5135DW1	Mot	DO	SOT363	dual pnp dtr 2k2+47k

### Codes beginning with '1'

Code	Device	Manufacturer	Base	Package	Leaded Equivalent/Data
1	2SC3587	Nec	CX	-	npn RF ft10GHz
1	BA277	Phi	I	SOD523	VHF Tuner band switch diode
1 (red)	BB669	Sie	I	SOD323	56-2.7 pF varicap
10	MRF9411L	Mot	X	SOT143	npn Rf 8GHz MRF941
10A	PZM10NB2A	Phi	A	SOT346	dual ca 10V 0.3W zener
10V	PZM10NB	Phi	C	SOT346	10V 0.3W zener
10Y	BZV49-C10	Phi	O	SOT89	10V 1W zener
11	MRF9511L	Mot	X	SOT143	npn RF 8GHz MRF951
11	MUN5311DW1	Mot	DP	SOT363	npn/pnp dtr 10k+10k
11	PDTA114EU	Phi	N	SOT416	pnp dtr
p11	PDTA114TT	Phi	N	SOT23	pnp dtr
t11	PDTA114TT	Phi	N	SOT23	pnp dtr
11A	PZM11NB2A	Phi	A	SOT346	dual ca 11V 0.3W zener
11A	MMBD1501A	Nat	C	SOT23	Si diode 200V 100mA
11V	PZM11NB	Phi	C	SOT346	11V 0.3W zener
11Y	BZV49-C11	Phi	O	SOT89	11V 1W zener
12	MUN5312DW1	Mot	DP	SOT363	npn/pnp dtr 22k+22k
12	DTA123EUA	Rho	N	SC70	pnp dtr 2k2+2k2 50V 100ma
12	DTA123EKA	Rho	N	SC59	pnp dtr 2k2+2k2 res 50V 100ma
p12	PDTC114TT	Phi	N	SOT23	npn dtr
t12	PDTC114TT	Phi	N	SOT23	npn dtr
12A	MMBD1502A	Nat	K	SOT23	Si diode 200V 100mA
12A	PZM12NB2A	Phi	A	SOT346	dual ca 12V 0.3W zener
12E	ZC2812E	Zet	D	SOT23	dual series RF schottky15V 20mA
12V	PZM12NB	Phi	C	SOT346	12V 0.3W zener
12Y	BZV49-C12	Phi	O	SOT89	12V 1W zener
13	DTA143EUA	Rho	N	SC70	pnp dtr 4k7+4k7 50V 100ma
13	DTA143EKA	Rho	N	SC59	pnp dtr 4k7+4k7 50V 100ma
13	DTA143ECA	Rho	N	SOT23	pnp dtr 4k7+4k7 50V 100ma

13t	BC846BPN	Phi	N	SOT363	BC546B
13s	BAS125	Sie	C	SOT23	Schottky sw 24V 100mA
13s	BAS125W	Sie	C	SOT323	Schottky sw 24V 100mA
13	MA4CS103A	M/A	C	SOT23	Schottky RF 20V 100mA
13	MUN5313DW1	Mot	DP	SOT363	nnp/pnp dtr 47k+47k
13A	MMBD1503A	Nat	D	SOT23	dual Si diode 200V 100mA
13A	PZM13NB2A	Phi	A	SOT346	dual ca 13V 0.3W zener
13E	ZC2813E	Zet	A	SOT23	dual ca RF schottky15V 20mA
13V	PZM13NB	Phi	C	SOT346	13V 0.3W zener
13Y	BZV49-C13	Phi	O	SOT89	13V 1W zener
14s	BAS125-04	Sie	D	SOT23	Dual series Schottky 25V 100mA
14s	BAS125-04W	Sie	D	SOT323	Dual series Schottky 25V 100mA
14	BAT114-099R	Sie	DQ	-	Quad Schottky crossover ring
14	DTA114EUA	Roh	N	SC70	pnp dtr 10k + 10k
14	DTA114EKA	Roh	N	SC59	pnp dtr 10k + 10k
14	MUN5314DW1	Mot	DP	SOT363	nnp/pnp dtr 10k R1
14	DTA114ECA	Roh	N	SOT23	pnp dtr 10k + 10k
14A	MMBD1504A	Nat	B	-	dual cc Si diode 200V 100mA
15s	BAS125-05	Sie	B	SOT23	dual cc Schottky 25V 100mA
15s	BAS125-05W	Sie	B	SOT323	dual cc Schottky 25V 100mA
15	DTA124EUA	Roh	N	SC70	pnp dtr 30V 50mA 22k+22k
15	DTA124EKA	Roh	N	SC59	pnp dtr 30V 50mA 22k+22k
15	DTA124ECA	Roh	N	SOT23	pnp dtr 30V 50mA 22k+22k
15	MUN5315DW1	Mot	DP	SOT363	nnp/pnp dtr 10k R1
15	MMBT3960	Mot	N	-	2N3960
15A	MMBD1505A	Nat	A	-	dual ca Si diode 200V 100mA
15A	PZM15NB2A	Phi	A	SOT346	dual ca 15V 0.3W zener
15V	PZM15NB	Phi	C	SOT346	15V 0.3W zener
15Y	BZV49-C15	Phi	O	SOT89	15V 1W zener
p16	PDTC114ET	Phi	N	SOT23	nnp dtr
t16	PDTC114EU	Phi	N	SOT323	nnp dtr
16s	BAS125-06	Sie	A	SOT23	dual ca Schottky 25V 100mA
16s	BAS125-06W	Sie	A	SOT323	dual ca Schottky 25V 100mA
16	MUN5316DW1	Mot	DP	SOT363	nnp/pnp dtr 4k7 R1
16	DTA144EUA	Roh	N	SC70	pnp dtr 30V 50mA 47k+47k
16	DTA144EKA	Roh	N	SC59	pnp dtr 30V 50mA 47k+47k
16V	PZM16NB	Phi	C	SOT346	16V 0.3W zener
16Y	BZV49-C16	Phi	O	SOT89	16V 1W zener
17s	BAS125-07	Sie	S	SOT143	dual Schottky 25V 100mA
17s	BAS125-07W	Sie	S	SOT343	dual Schottky 25V 100mA
p17	PDTC124ET	Phi	N	SOT23	nnp dtr
t17	PDTC124EU	Phi	N	SOT323	nnp dtr
18	BFP181T	Tfk	X	-	nnp Rf fT 7.8GHz 10V 20mA
18	PDTC143ZK	Phi	N	SOT346	nnp dtr 4k7+47k
p18	PDTC143ZT	Phi	N	SOT23	nnp dtr 4k7+47k
t18	PDTC143ZT	Phi	N	SOT23	nnp dtr 4k7+47k
18V	PZM18NB	Phi	C	SOT346	18V 0.3W zener
18Y	BZV49-C18	Phi	O	SOT89	18V 1W zener
19	PDTA143ZK	Phi	N	SOT346	pnp dtr 4k7+47k
19	DTA115EUA	Rho	N	SC70	pnp dtr 100k+100k 50V 100ma
19	DTA115EKA	Rho	N	SC59	pnp dtr 100k+100k 50V 100ma
p19	PDTA143ZT	Phi	N	SOT23	pnp dtr 4k7+47k
t19	PDTA143ZT	Phi	N	SOT23	pnp dtr 4k7+47k
100	SSTPAD100	Sil	J	SOT23	PAD-100 100pA leakage diode
101	PZM10NB1	Phi	C	SOT346	10V 0.3W zener
102	PZM10NB2	Phi	C	SOT346	10V 0.3W zener
103	PZM10NB3	Phi	C	SOT346	10V 0.3W zener
111	PZM11NB1	Phi	C	SOT346	11V 0.3W zener
111	DTA113ZUA	Roh	N	SC70	pnp dtr 1k+10k 50V 100mA
112	PZM11NB2	Phi	C	SOT346	11V 0.3W zener
113	PZM11NB3	Phi	C	SOT346	11V 0.3W zener
113	DTA143ZUA	Roh	N	SC70	pnp dtr 4k7+47k 50V 100mA
121	PZM12NB1	Phi	C	SOT346	12V 0.3W zener
121	DTC113ZUA	Roh	N	SC70	nnp dtr 1k+10k 50V 100mA
122	PZM12NB2	Phi	C	SOT346	12V 0.3W zener



123	PZM12NB3	Phi	C	SOT346	12V 0.3W zener
123	DTC143ZUA	Roh	N	SC70	npn dtr 4k7+47k 50V 100mA
131	PZM13NB1	Phi	C	SOT346	13V 0.3W zener
132	PZM13NB2	Phi	C	SOT346	13V 0.3W zener
132	DTA123JUA	Roh	N	SC70	pnp dtr 2k2+47k 50V 100mA
133	PZM13NB3	Phi	C	SOT346	13V 0.3W zener
142	DTA123JUA	Roh	N	SC70	npn dtr 2k2+47k 50V 100mA
151	PZM15NB1	Phi	C	SOT346	15V 0.3W zener
152	PZM15NB2	Phi	C	SOT346	15V 0.3W zener
153	PZM15NB3	Phi	C	SOT346	15V 0.3W zener
156	DTA144VUA	Roh	N	SC70	pnp dtr 47k+10k 50V 100mA
161	PZM16NB1	Phi	C	SOT346	16V 0.3W zener
162	PZM16NB2	Phi	C	SOT346	16V 0.3W zener
163	PZM16NB3	Phi	C	SOT346	16V 0.3W zener
166	DTC144VUA	Roh	N	SC70	npn dtr 47k+10k 50V 100mA
179	FMMT5179	Zet	N	-	2N5179
181	PZM18NB1	Phi	C	SOT346	18V 0.3W zener
182	PZM18NB2	Phi	C	SOT346	18V 0.3W zener
183	PZM18NB3	Phi	C	SOT346	18V 0.3W zener
1A	BC846A	Phi	N	SOT23	BC546A
1A	BC846AT	Phi	N	SOT416	BC546A
1Ap	BC846A	Phi	N	SOT23	BC546A
1At	BC846A	Phi	N	SOT23	BC546A
1At	BC846AW	Phi	N	SOT323	BC546A
1A-	BC846AW	Phi	N	SOT323	BC546A
1A	FMMT3904	Zet	N	SOT23	2N3904
1A	MMBT3904	Mot	N	SOT23	2N3904
1A	IRLML2402	IR	F	SOT23	n-ch mosfet 20V 0.9A
p1A	PMMT3904	Phi	N	SOT23	2N3904
p1A	PXT3904	Phi	N	SOT89	2N3904
t1A	PMMT3904	Phi	N	SOT23	2N3904
t1A	PMST3904	Phi	N	SOT323	2N3904
-1A	PMST3904	Phi	N	SOT323	2N3904
1AM	MMBT3904L	Mot	N	SOT23	2N3904
1B	BC846B	Phi	N	SOT23	BC546B
1B	BC846BT	Phi	N	SOT416	BC546B
1Bp	BC846B	Phi	N	SOT23	BC546B
1Bt	BC846B	Phi	N	SOT23	BC546B
1Bt	BC846BW	Phi	N	SOT323	BC546B
1B-	BC846BW	Phi	N	SOT323	BC546B
1B	FMMT2222	Zet	N	SOT23	2N2222
1B	MMBT2222	Mot	N	SOT23	2N2222
1B	IRLML2803	IR	F	SOT23	n-ch mosfet 30V 0.9A
p1B	PMBT2222	Phi	N	SOT23	2N2222
t1B	PMBT2222	Phi	N	SOT23	2N2222
t1B	PMST2222	Phi	N	SOT233	2N2222
-1B	PMST2222	Phi	N	SOT323	2N2222
1Bs	BC817UPN	Sie	N	SC74	-
1Cp	BAP50-05	Phi	B	SOT23	dual cc GP RF pin diode
1C	FMMT-A20	Zet	N	SOT23	MPSA20
1C	MMBTA20L	Mot	N	SOT23	MPS3904
1C	IRLML6302	IR	F	SOT23	p-ch mosfet 20V 0.6A
1Cs	BC847S	Sie	-	SOT363	BC457
1Dp	BC846	Phi	N	SOT23	BC456
1Dt	BC846	Phi	N	SOT23	BC456
1Dt	BC846W	Phi	N	SOT323	BC456
1D-	BC846W	Phi	N	SOT323	BC456
1D	MMBTA42	Mot	N	SOT23	MPSA42 300V npn
1D	IRLML5103	IR	F	SOT23	p-ch mosfet 30V 0.6A
p1D	PMBTA42	Phi	N	SOT23	MPSA42 300V npn
p1D	PXTA42	Phi	N	SOT89	MPSA42 300V npn
t1D	PMBTA42	Phi	N	SOT23	MPSA42 300V npn
t1D	PMSTA42	Phi	N	SOT323	MPSA42 300V npn
1Ds	BC846U	Sie	N	SC74	BC456
1Ds	BC846U	Sie	-	SOT363	BC456

<b>1DN</b>	2SC4083	Roh	N	-	npn 11V 3.2GHz TV tuners
<b>1DR</b>	MSD1328R	Mot	N	SOT346	npn gp 25V 500mA
<b>1E</b>	BC847A	Phi	N	SOT23	BC547A
<b>1E</b>	BC847AT	Phi	N	SOT416	BC547A
<b>1Ep</b>	BC847A	Phi	N	SOT23	BC547A
<b>1Et</b>	BC847A	Phi	N	SOT23	BC547A
<b>1Et</b>	BC847A	Phi	N	SOT323	BC547A
<b>1E-</b>	BC847A	Phi	N	SOT323	BC547A
<b>1ER</b>	BC847AR	Phi	R	SOT23R	BC547A
<b>1E</b>	FMMT-A43	Zet	N	-	MPSA43
<b>1E</b>	MMBTA43	Mot	N	SOT23	MPSA43 200V npn
<b>t1E</b>	PMBTA43	Mot	N	SOT23	MPSA43 200V npn
<b>t1E</b>	PMSTA43	Mot	N	SOT323	MPSA43 200V npn
<b>1Es</b>	BC847A	Sie	N	SOT23	BC457
<b>1Es</b>	BC847AW	Sie	N	SOT323	BC457
<b>1EN</b>	2SC4084	Roh	N	-	npn 20V 2.0GHz TV tuners
<b>1F</b>	BC847B	Phi	N	SOT23	BC547B
<b>1F</b>	BC847BT	Phi	N	SOT416	BC547B
<b>1Fs</b>	BC847B	Sie	N	SOT23	BC547B
<b>1Fs</b>	BC847BT	Sie	N	SC75	BC547B
<b>1Fs</b>	BC847BW	Sie	N	SOT323	BC547B
<b>1Fp</b>	BC847B	Phi	N	SOT23	BC547B
<b>1Ft</b>	BC847B	Phi	N	SOT23	BC547B
<b>1Ft</b>	BC847BW	Phi	N	SOT323	BC547B
<b>1F-</b>	BC847BW	Phi	N	SOT323	BC547B
<b>1FR</b>	BC847BR	Phi	R	SOT23R	BC547B
<b>1F</b>	MMBT5550	Mot	N	SOT23	2N5550 140V npn
<b>p1F</b>	PMBT5550	Phi	N	SOT23	2N5550 140V npn
<b>t1F</b>	PMBT5550	Phi	N	SOT23	2N5550 140V npn
<b>t1F</b>	PMST5550	Phi	N	SOT323	2N5550 140V npn
<b>1FZ</b>	FMBT5550	Zet	N	SOT23	2N5550 140V npn
<b>1G</b>	BC847C	Phi	N	SOT23	BC547C
<b>1G</b>	BC847CT	Phi	N	SOT416	BC547C
<b>1Gp</b>	BC847C	Phi	N	SOT23	BC547C
<b>1Gt</b>	BC847CW	Phi	N	SOT323	BC547C
<b>1G-</b>	BC847CW	Phi	N	SOT323	BC547C
<b>1Gs</b>	BC847C	Sie	N	SOT23	BC547C
<b>1Gs</b>	BC847CW	Sie	N	SOT323	BC547C
<b>1GR</b>	BC847CR	Phi	R	SOT23R	BC547C
<b>1GT</b>	SOA06	SGS	N	SOT23	MPSA06
<b>1G</b>	FMMT-A06	Zet	N	SOT23	MPSA06
<b>1G</b>	MMBTA06	Mot	N	SOT23	MPSA06
<b>p1G</b>	PMMTA06	Phi	N	SOT23	MPSA06
<b>t1G</b>	PMMTA06	Phi	N	SOT23	MPSA06
<b>t1G</b>	PMMTA06	Phi	N	SOT323	MPSA06
<b>1GM</b>	MMBTA06	Mot	N	SOT23	MPSA06
<b>1Hp</b>	BC847	Phi	N	SOT23	BC547
<b>1Ht</b>	BC847	Phi	N	SOT23	BC547
<b>1Ht</b>	BC847W	Phi	N	SOT323	BC547
<b>1H-</b>	BC847W	Phi	N	SOT323	BC547
<b>1H</b>	FMMT-A05	Zet	N	-	MPSA05
<b>1H</b>	MMBTA05	Mot	N	SOT23	MPSA05
<b>t1H</b>	MMBTA05	Phi	N	SOT323	MPSA05
<b>1HT</b>	SOA05	SGS	N	SOT23	MPSA05
<b>1J</b>	BC848A	Phi	N	SOT23	BC548A
<b>1Js</b>	BC848A	Sie	N	SOT23	BC548A
<b>1Js</b>	BC848AW	Sie	N	SOT323	BC548A
<b>1J</b>	FMMT2369	Zet	N	SOT23	2N2369
<b>1J</b>	MMBT2369	Mot	N	SOT23	MPS2369
<b>1Js</b>	BCV61A	Sie	VQ	SOT143	npn current mirror hFe 180
<b>1Jp</b>	BCV61A	Phi	VQ	SOT143	npn current mirror hFe 180
<b>p1J</b>	PMBT2369	Phi	N	SOT23	2N2369
<b>t1J</b>	PMBT2369	Phi	N	SOT23	2N2369
<b>t1J</b>	PMBT2369	Phi	N	SOT323	2N2369
<b>1JA</b>	MMBT2369A	Mot	N	SOT23	MPS2369A

<b>1JR</b>	BC848AR	Phi	R	SOT23R	BC548A
<b>1JZ</b>	BC848A	Zet	N	SOT23	BC548A
<b>1K</b>	BC848B	ITT	N	SOT23	BC548B
<b>1Kp</b>	BC848B	Phi	N	SOT23	BC548B
<b>1Ks</b>	BC848B	Sie	N	SOT23	BC548B
<b>1Ks</b>	BC848BW	Sie	N	SOT323	BC548B
<b>1K</b>	MMBT6428	Mot	N	SOT23	MPSA18 50V
<b>p1K</b>	PMBT6428	Phi	N	SOT23	MPSA18 50V
<b>t1K</b>	PMBT6428	Phi	N	SOT23	MPSA18 50V
<b>t1K</b>	PMBT6428	Phi	N	SOT323	MPSA18 50V
<b>1K</b>	FMMT4400	Zet	N	SOT23	2N4400
<b>1Ks</b>	BCV61B	Sie	VQ	SOT143B	npn current mirror hFe 290
<b>1Kp</b>	BCV61B	Phi	VQ	SOT143B	npn current mirror hFe 290
<b>1KR</b>	BC848BR	Phi	R	SOT23R	BC548B
<b>1KM</b>	MMBT6428L	Mot	N	SOT23	MPSA18 50V
<b>1KZ</b>	FMMT4400	Zet	N	SOT23	2N4400
<b>1L</b>	BC848C	ITT	N	SOT23	BC548C
<b>1Lp</b>	BC848C	Phi	N	SOT23	BC548C
<b>1Ls</b>	BC848C	Sie	N	SOT23	BC548C
<b>1Ls</b>	BC848CW	Sie	N	SOT323	BC548C
<b>1L</b>	MMBT6429	Mot	N	-	MPSA18 45V
<b>1L</b>	FMMT4401	Zet	N	-	2N4401
<b>1L</b>	BCV61C	Sie	VQ	SOT143B	npn current mirror hFe 520
<b>1Lp</b>	BCV61C	Phi	VQ	SOT143B	npn current mirror hFe 520
<b>p1L</b>	PMBT6429	Phi	N	SOT23	MPSA18 45V
<b>t1L</b>	PMBT6429	Phi	N	SOT23	MPSA18 45V
<b>t1L</b>	PMBT6429	Phi	N	SOT323	MPSA18 45V
<b>1LR</b>	BC848CR	Phi	R	SOT23R	BC548C
<b>1Mp</b>	BC848	Phi	N	SOT23	BC548
<b>1M</b>	MMBTA13	Mot	N	SOT23	MPSA13 darlington
<b>1Mp</b>	BCV61	Phi	VQ	SOT143B	npn current mirror
<b>1M</b>	FMMT-A13	Zet	N	SOT23	MPSA13
<b>p1M</b>	PXTA13	Phi	N	SOT89	MPSA13 darlington
<b>p1M</b>	PMBTA13	Phi	N	SOT23	MPSA13 darlington
<b>t1M</b>	PMBTA13	Phi	N	SOT23	MPSA13 darlington
<b>1N</b>	FMMT-A14	Zet	N	SOT23	MPSA14
<b>1N</b>	MMBTA14	Mot	N	SOT23	MPSA14 darlington
<b>1N5</b>	ZTX11N15DF	Zet	N	SOT23	npn 15V 3A low saturation V
<b>p1N</b>	PMBTA14	Mot	N	SOT23	MPSA14 darlington
<b>p1N</b>	PXTA14	Mot	N	SOT89	MPSA14 darlington
<b>t1N</b>	PMBTA14	Mot	N	SOT23	MPSA14 darlington
<b>1P</b>	FMMT2222A	Zet	N	-	2N2222A
<b>1P</b>	MMBT2222A	Mot	N	SOT23	2N2222A
<b>1P</b>	BC847PN	Sie	DI	-	pnp/npn separate pair gp AF
<b>p1P</b>	PMBT2222A	Phi	N	SOT23	2N2222A
<b>p1P</b>	PXT2222A	Phi	N	SOT89	2N2222A
<b>t1P</b>	PMBT2222A	Phi	N	SOT23	2N2222A
<b>t1P</b>	PMST2222A	Phi	N	SOT323	2N2222A
<b>1Q</b>	MMBT5088	Mot	N	SOT23	MPSA18 Vce 30V
<b>p1Q</b>	PMBT5088	Phi	N	SOT23	MPSA18 Vce 30V
<b>t1Q</b>	PMBT5088	Phi	N	SOT23	MPSA18 Vce 30V
<b>t1Q</b>	PMST5088	Phi	N	SOT323	MPSA18 Vce 30V
<b>1R</b>	MMBT5089	Mot	N	SOT23	MPSA18 Vce 25V
<b>t1R</b>	PMST5089	Phi	N	SOT323	MPSA18 Vce 25V
<b>1S</b>	MMBT2369A	Nat	N	SOT23	2N2369A 500MHz sw npn
<b>1S</b>	MSC3130	Mot	H	SOT346	npn RF fT 1.4GHz 10V
<b>1T</b>	MMBT3960A	Mot	N	-	2N3960A
<b>1U</b>	MMBT2484L	Mot	N	SOT23	MPSA18
<b>1V</b>	MMBT6427	Mot	H	SOT23	2N6426/7 darlington npn
<b>1Vp</b>	BF820	Phi	N	SOT23	npn 300V 50mA BF420
<b>1Vt</b>	BF820	Phi	N	SOT23	npn 300V 50mA BF420
<b>1Vt</b>	BF820W	Phi	N	SOT323	npn 300V 50mA BF420
<b>1V-</b>	BF820W	Phi	N	SOT323	npn 300V 50mA BF420
<b>1W</b>	FMMT3903	Zet	N	SOT23	2N3903

<b>1Wp</b>	BF821	Phi	N	SOT23	pnP 300V 50mA BF421
<b>1Wt</b>	BF821	Phi	N	SOT23	pnP 300V 50mA BF421
<b>1W t</b>	BF822W	Phi	N	SOT323	pnP 300V 50mA BF421
<b>1W -</b>	BF822W	Phi	N	SOT323	pnP 300V 50mA BF421
<b>1X</b>	MMBT930L	Mot	N	SOT23	MPS3904
<b>1Xp</b>	BF822	Phi	N	SOT23	npn 250V 50mA BF422
<b>1Xt</b>	BF822	Phi	N	SOT23	npn 250V 50mA BF422
<b>1Y</b>	MMBT3903	Mot	N	SOT23	2N3903
<b>1Yp</b>	BF823	Phi	N	SOT23	pnP 250V 50mA BF423
<b>1Yt</b>	BF823	Phi	N	SOT23	pnP 250V 50mA BF423
<b>1Z</b>	BAS70-06	Zet	A	SOT23	dual RF CA schottky diode
<b>1Z</b>	MMBT6517	Mot	N	SOT23	2N6517 npn Vce 350V

### Codes beginning with '2'

Code	Device	Manufacturer	Base	Package	Leaded Equivalent/Data
<b>2</b>	BAT62-02W	Sie	I	SCD80	BAT16 schottky diode
<b>2 (blue)</b>	BAR64-03W	Sie	I	SOD323	pin diode
<b>2</b>	2SC3604	Nec	CX	-	npn RF fT8GHz 12dB @2GHz
<b>2 (white)</b>	BB439	Sie	I	SOD323	29-5 pF varicap
<b>20</b>	MRF5811	Mot	X	SOT143	npn Rf fT 5GHz 0.2A
<b>-20</b>	PDTC114WU	Phi	N	SOT323	npn dtr
<b>20F</b>	TSDf1220	Tfk	X	SOT143	fT 12GHz npn 6V 20mA
<b>20V</b>	PZM20NB	Phi	C	SOT346	20V 300mW zener
<b>20Y</b>	BZV49-C20	Phi	O	SOT89	20V 1W zener
<b>21</b>	Gali-21	MC	AZ	SOT89	DC-8GHz MMIC amp 14 dB gain
<b>22</b>	MMBT4209	Nat	N	SOT23	pnP sw 850MHz 2N4209
<b>22</b>	DTC123EUA	Rho	N	SC70	npn dtr 2k2+2k2 50V 100ma
<b>22</b>	DTC123EKA	Rho	N	SC59	npn dtr 2k2+2k2 50V 100ma
<b>22V</b>	PZM22NB	Phi	C	SOT346	22V 300mW zener
<b>22Y</b>	BZV49-C22	Phi	O	SOT89	22V 1W zener
<b>23</b>	MMBT3646	Nat	N	SOT23	npn sw 350MHz 2N3646
<b>23</b>	DTC143EUA	Roh	N	SC70	pnP dtr 50V 100mA 4k7+ 4k7
<b>23</b>	DTC143EKA	Roh	N	SC59	pnP dtr 50V 100mA 4k7+ 4k7
<b>-23</b>	PDTA114TU	Phi	N	SOT323	pnP dtr R1 10k
<b>t23</b>	PDTA114TU	Phi	N	SOT323	pnP dtr R1 10k
<b>24</b>	MMBD2101	Nat	C	SOT23	Si diode 100V 200mA
<b>24</b>	DTC114ECA	Roh	N	SOT23	npn dtr 50V 100mA 10k + 10k
<b>24</b>	DTC114EUA	Roh	N	SC70	npn dtr 50V 100mA 10k + 10k
<b>24</b>	DTC114EKA	Roh	N	SC59	npn dtr 50V 100mA 10k + 10k
<b>24</b>	2SC5006	Nec	N	-	npn RF fT 4.5GHz @3V 7mA
<b>-24</b>	PDTC114TU	Phi	N	SOT323	npn dtr R1 10k
<b>t24</b>	PDTC114TU	Phi	N	SOT323	npn dtr R1 10k
<b>24V</b>	PZM24NB	Phi	C	SOT346	24V 300mW Zener
<b>24Y</b>	BZV49-C24	Phi	O	SOT89	24V 1W zener
<b>25</b>	MMBD2102	Nat	K	SOT23	Si diode 100V 200mA
<b>25</b>	DTC124ECA	Roh	N	SOT23	npn dtr 50V 100mA 22k + 22k
<b>25</b>	DTC124EKA	Roh	N	SC59	npn dtr 50V 100mA 22k + 22k
<b>25</b>	DTC124EUA	Roh	N	SC70	npn dtr 50V 100mA 22k + 22k
<b>26</b>	MMBD2103	Nat	D	SOT23	dual MMBD1201
<b>26</b>	DTC144EKA	Roh	N	SC59	npn dtr 50V 30mA 47k + 47k
<b>26</b>	DTC144EUA	Roh	N	SC70	npn dtr 50V 30mA 47k + 47k
<b>27</b>	MMBD2104	Nat	B	SOT23	dual cc MMBD1201
<b>27V</b>	PZM27NB	Phi	C	SOT346	27V 300mW Zener
<b>27Y</b>	BZV49-C27	Phi	O	SOT89	27V 1W zener
<b>28</b>	BFP280T	Tfk	W	-	npn RF fT 7GHz 8V 10mA
<b>28</b>	MMBD2105	Nat	A	SOT23	dual ca MMBD1201
<b>-28</b>	PDTA114WU	Phi	N	SOT323	pnP dtr
<b>29</b>	MMBD1401	Nat	C	SOT23	Si diode 200V 100mA
<b>29</b>	DTC115EE	Roh	N	EMT3	npn dtr 100k +100k 50V 20mA
<b>29</b>	DTC115EUA	Roh	N	SC70	npn dtr 100k +100k 50V 20mA
<b>29</b>	DTC115EKA	Roh	N	SC59	npn dtr 100k +100k 50V 20mA
<b>200</b>	SSTPAD200	Sil	J	-	PAD-200 200pA leakage diode
<b>201</b>	PZM20NB1	Phi	C	SOT346	20V 300mW Zener

202	PZM20NB2	Phi	C	SOT346	20V 300mW Zener
203	PZM20NB3	Phi	C	SOT346	20V 300mW Zener
221	PZM22NB1	Phi	C	SOT346	22V 300mW Zener
222	PZM22NB2	Phi	C	SOT346	22V 300mW Zener
223	PZM22NB3	Phi	C	SOT346	22V 300mW Zener
241	PZM24NB	Phi	C	SOT346	24V 300mW Zener
242	PZM24NB	Phi	C	SOT346	24V 300mW Zener
243	PZM20NB	Phi	C	SOT346	24V 300mW Zener
271	PZM2.7NB1	Phi	C	SOT346	2.7V 300mW Zener
272	PZM2.7NB2	Phi	C	SOT346	2.7V 300mW Zener
2A	MMBT3906L	Mot	N	SOT23	2N3906
2A	MMBT3906W	Mot	N	SOT323	2N3906
2A	FMMT3906	Zet	N	SOT23	2N3906
t2A	PMBT3906	Phi	N	SOT23	2N3906
t2A	PMST3906	Phi	N	SOT323	2N3906
p2A	PMBT3906	Phi	N	SOT23	2N3906
p2A	PXT3906	Phi	O	SOT89	2N3906
2A4	PZM2.4NB2A	Phi	A	SOT346	dual 2.4V cc Zener
2A7	PZM2.7NB2A	Phi	A	SOT346	dual 2.7V cc Zener
2B	BC849B	ITT	N	SOT23	BC549B
2Bs	BC849B	Sie	N	SOT23	BC549B
2Bs	BC849BW	Sie	N	SOT323	BC549B
2Bp	BC849B	Phi	N	SOT23	BC549B
2Bt	BC849BW	Phi	N	SOT323	BC549B
2B-	BC849BW	Phi	N	SOT323	BC549B
2B	FMMT2907	Zet	N	SOT23	2N2907
2B	MMBT2907	Mot	N	SOT23	MPS2907
p2B	PMBT2907	Phi	N	SOT23	2N2907
t2B	PMBT2907	Phi	N	SOT23	2N2907
2BR	BC849BR	Phi	R	SOT23R	BC549B
2BZ	FMMT2907	Zet	N	SOT23	2N2907
2C	BC849C	ITT	N	SOT23	BC549C
2Cs	BC849C	Sie	N	SOT23	BC549C
2Cs	BC849CW	Sie	N	SOT323	BC549C
2Cp	BC849C	Phi	N	SOT23	BC549C
2Ct	BC849C	Phi	N	SOT23	BC549C
2Ct	BC849CW	Phi	N	SOT323	BC549C
2C-	BC849CW	Phi	N	SOT323	BC549C
2C	MMBTA70	Mot	N	SOT23	MPSA70
2CR	BC849CR	Phi	R	SOT23R	BC549C
2CZ	FMMTA70	Zet	N	SOT23	MPSA70
2D	MMBTA92	Mot	N	SOT23	MPSA92 pnp Vce 300V
p2D	PMBTA92	Phi	N	SOT23	MPSA92 pnp Vce 300V
p2D	PXTA92	Phi	O	SOT89	MPSA92 pnp Vce 300V
t2D	PMBTA92	Phi	N	SOT23	MPSA92 pnp Vce 300V
t2D	PMSTA92	Phi	N	SOT323	MPSA92 pnp Vce 300V
2E	MMBTA93	Mot	N	SOT23	MPSA93 pnp Vce 200V
2E	FMMT-A93	Zet	N	SOT23	MPSA93
t2E	PMBTA93	Phi	N	SOT23	MPSA93 pnp Vce 200V
t2E	PMSTA93	Phi	N	SOT323	MPSA93 pnp Vce 200V
2F	BC850B	ITT	N	SOT23	BC550B
2Fs	BC850B	Sie	N	SOT23	BC550B
2Fs	BC850BW	Sie	N	SOT323	BC550B
2Fp	BC850B	Phi	N	SOT23	BC550B
2Ft	BC850B	Phi	N	SOT23	BC550B
2Ft	BC850BW	Phi	N	SOT323	BC550B
2F-	BC850BW	Phi	N	SOT323	BC550B
2F	FMMT2907A	Zet	N	SOT23	2N2907A
2F	MMBT2907A	Mot	N	SOT23	MPS2907A
2F	MMBT2907AW	Mot	N	SOT323	MPS2907A
p2F	PMBT2907A	Phi	N	SOT23	2N2907A
p2F	PXT2907A	Phi	O	SOT89	2N2907A
t2F	PMBT2907A	Phi	N	SOT23	2N2907A
t2F	PMBT2907A	Phi	N	SOT323	2N2907A
2FR	BC850BR	Phi	R	SOT23R	BC550B

2G	BC850C	ITT	N	SOT23	BC550C
2Gs	BC850C	Sie	N	SOT23	BC550C
2Gp	BC850C	Phi	N	SOT23	BC550C
2Gt	BC850C	Phi	N	SOT323	BC550C
2Gt	BC850CW	Phi	N	SOT323	BC550C
2G-	BC850CW	Phi	N	SOT323	BC550C
2G	FMMT-A56	Zet	N	SOT23	MPSA56
2G	MMBTA56	Mot	N	SOT23	MPSA56
p2G	PMBTA56	Phi	N	SOT23	MPSA56
t2G	PMBTA56	Phi	N	SOT23	MPSA56
t2G	PMSTA56	Phi	N	SOT323	MPSA56
2GM	MMBTA56	Mot	N	SOT23	MPSA56
2GR	BC850CR	Phi	R	SOT23R	BC550C
2GT	SOA56	SGS	N	SOT23	MPSA56
2H	FMMT-A55	Zet	N	SOT23	MPSA55
2HT	SOA55	SGS	N	SOT23	MPSA55
2H	MMBTA55	Mot	N	SOT23	MPSA55
t2H	PMBTA55	Phi	N	SOT23	MPSA55
t2H	PMSTA55	Phi	N	SOT323	MPSA55
2J	MMBT3640	Mot	N	SOT23	MPS3640 pnp sw
2K	FMMT4402	Zet	N	SOT23	2N4402
2K	MMBT8598	Mot	N	-	2N4125 pnp 60V
2L	MMBT5401	Mot	N	SOT23	2N5401 pnp 150V
2L	FMMT4403	Zet	N	SOT23	2N4403
p2L	PMBT5401	Phi	N	SOT23	2N5401 pnp 150V
t2L	PMBT5401	Phi	N	SOT23	2N5401 pnp 150V
t2L	PMST5401	Phi	N	SOT323	2N5401 pnp 150V
2M	FMMT5087	Zet	N	SOT23	2N5087
2M	MMBT404	Mot	N	SOT23	pnp-chopper 24V 150mA
2N	MMBT404A	Mot	N	SOT23	pnp-chopper 35V 150mA
2N0	ZXT11N20DF	Zet	N	SOT23	npn 20V 2.5A low sat switch
2P	FMMT2222R	Zet	R	SOT23R	2N2222
2P	MMBT5086	Mot	N	SOT23	2N5086
2Q	MMBT5087	Mot	N	SOT23	2N5087
2R	HSMS-8102	HP	Z	SOT23	10-14GHz schottky mixer pair
2T	SO4403	SGS	N	SOT23	2N4403
2T	MMBT4403	Mot	N	SOT23	2N4403
p2T	PMBT4403	Phi	N	SOT23	2N4403
p2T	PXT4403	Phi	O	SOT89	2N4403
t2T	PMBT4403	Phi	N	SOT23	2N4403
t2T	PMST4403	Phi	N	SOT323	2N4403
2T	HT2	Zet	N	SOT23	pnp 80V 100mA
2U	MMBTA63	Mot	N	SOT23	MPSA63 darlington
t2U	PMBTA63	Phi	N	SOT23	MPSA63 darlington
2V	MMBTA64	Mot	N	SOT23	MPSA64 darlington
p2V	PXTA64	Phi	O	SOT89	MPSA64 darlington
t2V	PMBTA64	Phi	H	SOT23	MPSA64 darlington
2V4	PZM2.4NB	Phi	C	SOT346	2.4V 300mW Zener
2V7	PZM2.7NB	Phi	C	SOT346	2.7V 300mW Zener
2W	FMMT3905	Zet	N	SOT23	2N3905
2W	MMBT8599	Mot	N	-	2N4125 Vce 80V pnp
2X	SO4401	SGS	N	SOT23	2N4401
2X	MMBT4401	Mot	N	SOT23	2N4401
p2X	PMBT4401	Phi	N	SOT23	2N4401
p2X	PxT4401	Phi	O	SOT89	2N4401
t2X	PMBT4401	Phi	N	SOT23	2N4401
t2X	PMST4401	Phi	N	SOT323	2N4401
2Y4	BZV49-C2V4	Phi	O	SOT89	2.4V 1W zener
2Y7	BZV49-C2V7	Phi	O	SOT89	2.7V 1W zener
2Z	MMBT6520	Mot	N	SOT23	2N6520 pnp Vce 350V
2Z	BAS70-04	Zet	D	SOT23	dual series RF schottky 70V 15mA
2Z5	BAS70-05	Zet	B	SOT23	dual cc RF Schottky 70V 15mA

Codes beginning with '3'

Code	Device	Manufacturer	Base	Package	Leaded Equivalent/Data
3	BAT60A	Sie	I	SOD323	10V 3A sw schottky
3	BAT62-02W	Sie	I	SCD80	-
30	MUN5330DW1	Mot	DP	SOT363	npn/pnp dtr 1k0+1k0
30V	PZM30NB1	Phi	C	SOT346	30V 300mW zener
30Y	BZV49-C30	Phi	O	SOT89	30V 1W zener
301	FDV301N	Fch	M	SOT23	n-ch 'digital' fet 25V 0.22A
302	FDV302P	Fch	M	SOT23	p-ch 'digital' fet 25V 0.13A
303	FDV303N	Fch	M	SOT23	n-ch 'digital' fet 25V 0.68A
304	FDV304P	Fch	M	SOT23	p-ch 'digital' fet 25V 0.46A
31	MUN5331DW1	Mot	DP	SOT363	npn/pnp dtr 2k2+2k2
31	MMBD1402	Nat	K	SOT23	Si diode 200V 100mA
p31	PDTA143XT	Phi	N	SOT23	pnp dtr 4k7+10k
t31	PDTA143XT	Phi	N	SOT23	pnp dtr4k7+10k
32	MUN5332DW1	Mot	DP	SOT363	npn/pnp dtr 4k7+4k7
32	MMBD1403	Nat	D	SOT23	dual Si diode 200V 100mA
32	BAT32	Sie	CS	-	18GHz zero-bias schottky
p32	PDTC143XT	Phi	N	SOT23	pnp dtr 4k7+10k
t32	PDTC143XT	Phi	N	SOT23	pnp dtr 4k7+10ks
33	MUN5333DW1	Mot	DP	SOT363	npn/pnp dtr 4k7+47k
33	DTA143XE	Roh	N	EMT3	pnp dtr 4k7+10k 50V 100mA
33	DTA143XUA	Roh	N	SC70	pnp sw 4k7+10k bias res 50V 100mA
33	DTA143XKA	Roh	N	SC59	pnp sw 4k7+10k bias res 50V 100mA
33	MMBD1404	Nat	B	SOT23	dual cc Si diode 200V 100mA
33	Gali-33	MC	AZ	SOT89	DC-4GHz MMIC amp 19dB gain
33V	PZM33NB1	Phi	C	SOT346	33 300mW zener
33Y	BZV49-C33	Phi	O	SOT89	33V 1W zener
34	MUN5334DW1	Mot	DP	SOT363	npn/pnp dtr 22k+47k
34	MMBD1405	Nat	A	SOT23	dual ca Si diode 200V 100mA
331	NDS331N	Fch	M	SOT23	n-ch mosfet 1.3A 20V
331	PZM3.3NB1	Phi	C	SOT346	3.3V 300mW zener
332	PZM3.3NB2	Phi	C	SOT346	3.3V 300mW zener
332	NDS332N	Fch	M	SOT23	p-ch mosfet 0.4A, 1A pk, 20V
335	NDS335N	Fch	M	SOT23	n-ch mosfet 70 mA, 1.7A pk, 20V
336	NDS336N	Fch	M	SOT23	p-ch mosfet 0.27A, 1.2A pk, 20V
337	NDS337N	Fch	M	SOT23	n-ch mosfet 50 mA, 2.5A pk 20V
338	NDS338N	Fch	M	SOT23	p-ch mosfet 0.13A, 1.6Apk 20V
34	2SC5007	Nec	N	-	npn RF FT 7GHz @3V 7mA
340	FDV340P	Fch	M	SOT23	p-ch mosfet 20V 70 mA
35	MUN5335DW1	Mot	DP	SOT363	npn/pnp dtr 2k2+47k
35	DTA124XE	Roh	N	EMT3	pnp dtr 22k+47k 50V 50mA
35	DTA124XUA	Roh	N	SC70	pnp dtr 22k+47k 50V 50mA
35	DTA124XKA	Roh	N	SC59	pnp dtr 22k+47k 50V 50mA
351	NDS351N	Fch	M	SOT23	n-ch mosfet 1.1A 30V
352	NDS352N	Fch	M	SOT23	p-ch mosfet 0.5A 20V
355	NDS355N	Fch	M	SOT23	n-ch mosfet 0.1A, 1.6A pk 30V
356	NDS356N	Fch	M	SOT23	p-ch mosfet 0.3A, 1.1A pk 20V
357	NDS357N	Fch	M	SOT23	n-ch mosfet 2.5Apk 30V
358	NDS358N	Fch	M	SOT23	p-ch mosfet 0.2A, 1.6A pk 30V
358	FDN358N	Fch	M	SOT23	p-ch mosfet 0.2A 1.6A pk 30V
360	FDN360P	Fch	M	SOT23	p-ch mosfet 80mA, 2a PK, 30V
361	PZM3.6NB1	Phi	C	SOT346	3.6V 300mW Zener
362	PZM3.3NB2	Phi	C	SOT346	3.6V 300mW Zener
36V	PZM36NB1	Phi	C	SOT346	36V 300mW Zener
36Y	BZV49-C36	Phi	O	SOT89	36V 1W zener
391	PZM3.9NB1	Phi	C	SOT346	3.9V 300mW Zener
392	PZM3.9NB2	Phi	C	SOT346	3.9V 300mW Zener
39V	PZM39NB1	Phi	C	SOT346	39V 300mW Zener
39Y	BZV49-C39	Phi	O	SOT89	39V 1W zener
3A	BC856A	ITT	N	SOT23	BC556A
3A	BC856AT	Phi	N	SOT416	BC556A
3Ap	BC856A	Phi	N	SOT23	BC556A
3At	BC856A	Phi	N	SOT23	BC556A
3As	BC856A	Sie	N	SOT23	BC556A
3At	BC856AW	Phi	N	SOT323	BC556A

<b>3A-</b>	BC856AW	Phi	N	SOT323	BC556A
<b>3A</b>	MMBTH24	Mot	N	SOT23	VHF mixer npn fT 600MHz
<b>3A0</b>	PZM3.0NB2A	Phi	C	SOT346	dual 3.0V Zener
<b>3A3</b>	PZM3.3NB2A	Phi	C	SOT346	dual 3.3V Zener
<b>3A6</b>	PZM3.6NB2A	Phi	C	SOT346	dual 3.6V Zener
<b>3A9</b>	PZM3.9NB2A	Phi	C	SOT346	dual 3.9V Zener
<b>3AR</b>	BC856AR	Phi	R	SOT23R	BC556A
<b>3B</b>	BC856B	ITT	N	SOT23	BC556B
<b>3B</b>	BC856BT	Phi	N	SOT416	BC556B
<b>3Bp</b>	BC856B	Phi	N	SOT23	BC556B
<b>3Bs</b>	BC856B	Sie	N	SOT23	BC556B
<b>3Bt</b>	BC856B	Phi	N	SOT23	BC556B
<b>3Bt</b>	BC856BW	Phi	N	SOT323	BC556B
<b>3B-</b>	BC856BW	Phi	N	SOT323	BC556B
<b>3B</b>	FMMT918	Zet	N	SOT23	2N918
<b>3B</b>	MMBT918	Mot	N	SOT23	2N918
<b>3BR</b>	BC856BR	Phi	R	SOT23	BC556B
<b>3C</b>	FMMTA20R	Zet	R	SOT23R	MPSA20
<b>3C</b>	BC857	Sie	DO	-	pnp separate pair gp AF
<b>3D</b>	BC856	Phi	N	SOT23	BC556 hfe 75 min
<b>3Dp</b>	BC856	Phi	N	SOT23	BC556 hfe 75 min
<b>3Dt</b>	BC856	Phi	N	SOT23	BC556 hfe 75 min
<b>3Dt</b>	BC856W	Phi	N	SOT323	BC556 hfe 75 min
<b>3D-</b>	BC856W	Phi	N	SOT323	BC556 hfe 75 min
<b>3D</b>	MMBTH81L	Mot	N	SOT23	UHF pnp fT 600MHz
<b>3D</b>	BC856S	Sie	DO	-	pnp separate pair gp AF
<b>3E</b>	BC857A	Phi	N	SOT23	BC557A
<b>3E</b>	BC857AT	Phi	N	SOT416	BC557A
<b>3Ep</b>	BC857A	Phi	N	SOT23	BC557A
<b>3Et</b>	BC857A	Phi	N	SOT23	BC557A
<b>3Et</b>	BC857A	Phi	N	SOT323	BC557A
<b>3E-</b>	BC857A	Phi	N	SOT323	BC557A
<b>3E</b>	MMBTH10	Mot	N	SOT23	MPSH10 fT 650MHz
<b>3E</b>	FMMT-A42	Zet	N	SOT23	MPSA42
<b>3EM</b>	MMBTH10L	Mot	N	SOT23	VHF amp 650MHz fT
<b>3ER</b>	BC857AR	Phi	R	SOT23R	BC557A
<b>3EZ</b>	FMMTH10	Zet	N	SOT23	nnp fT 650MHz
<b>3F</b>	BC857B	Phi	N	SOT23	BC557B
<b>3F</b>	BC857BT	Phi	N	SOT416	BC557B
<b>3Fp</b>	BC857B	Phi	N	SOT23	BC557B
<b>3Fs</b>	BC857B	Sie	N	SOT23	BC557B
<b>3Ft</b>	BC857B	Phi	N	SOT23	BC557B
<b>3Ft</b>	BC857BW	Phi	N	SOT323	BC557B
<b>3Ft</b>	BC857BS	Phi	N	SOT363	BC557B
<b>3F-</b>	BC857BW	Phi	N	SOT323	BC557B
<b>3FR</b>	BC857BR	Phi	R	SOT23R	BC557B
<b>3G</b>	BC857C	Phi	N	SOT23	BC557C
<b>3Gp</b>	BC857C	Phi	N	SOT23	BC557C
<b>3G</b>	BC857C	Phi	N	SOT23	BC557C
<b>3Gs</b>	BC857C	Sie	N	SOT23	BC557C
<b>3Gt</b>	BC857C	Phi	N	SOT23	BC557C
<b>3Gt</b>	BC857CW	Phi	N	SOT323	BC557C
<b>3G-</b>	BC857CW	Phi	N	SOT323	BC557C
<b>3G</b>	MMBTH11	NS	N	SOT23	-
<b>3G</b>	MGSF3454X	Mot	DK	TSOP6	n-ch enh tmosfet 1.75A
<b>3GR</b>	BC857CR	Phi	R	SOT23R	BC557CR
<b>3Hp</b>	BC857C	Phi	N	SOT23	BC557
<b>3Ht</b>	BC857C	Phi	N	SOT23	BC557
<b>3Ht</b>	BC857CW	Phi	N	SOT323	BC557
<b>3H</b>	MMBTH30	NS	N	SOT23	-
<b>3H-</b>	BC857CW	Phi	N	SOT323	BC557
<b>3J</b>	MMBTH69	Mot	N	SOT23	pnp UHF fT 2GHz
<b>3J</b>	BC858A	Phi	N	SOT23	BC558A
<b>3Js</b>	BC858A	Sie	N	SOT23	BC558A
<b>3JR</b>	BC858AR	Phi	R	SOT23R	BC558A



3Js	BCV62A	Sie	VQ	SOT143	pnnp current mirror hFe 180
3Jp	BCV62A	Phi	VQ	SOT143	pnnp current mirror hFe 180
3K	BC858B	Phi	N	SOT23	BC558B
3Ks	BCV62B	Sie	VQ	SOT143	npn current mirror hFe 290
3Kp	BCV62B	Phi	VQ	SOT143	npn current mirror hFe 290
3KR	BC858BR	Phi	R	SOT23R	BC558B
3L	BC858C	Phi	N	SOT23	BC558C
3LR	BC858CR	Phi	R	SOT23R	BC558C
3Ls	BCV62C	Sie	VQ	SOT143	pnnp current mirror hFe 520
3Lp	BCV62C	Phi	VQ	SOT143	pnnp current mirror hFe 520
3M	BC858	Phi	N	SOT23	BC558
3M	FMMT5087R	Zet	R	SOT23R	2N5087 BC322
3Ms	BCV62	Sie	VQ	SOT143	pnnp current mirror
3Mp	BCV62	Phi	VQ	SOT143	pnnp current mirror
3N	MMBT4402	Nat	N	SOT23	2N4402 pnp
3P	FMT2222AR	Zet	R	SOT23R	2N2222A
3R	MMBT5571	Nat	N	SOT23	pnnp sw 850MHz
3S	MMBT5551	Nat	N	SOT23	npn 160V
3T	HT3	Zet	N	SOT23	npn 80V 100mA
3V0	PZM3.0NB	Phi	C	SOT346	3.0V 300mW Zener
3V3	PZM3.3NB	Phi	C	SOT346	3.3V 300mW Zener
3V6	PZM3.6NB	Phi	C	SOT346	3.6V 300mW Zener
3V9	PZM3.9NB	Phi	C	SOT346	3.9V 300mW Zener
3W	FMMT-A12	Zet	N	-	MPSA12
3Y3	BZV49-C3V3	Phi	O	SOT89	3.3V 1W zener
3Y6	BZV49-C3V6	Phi	O	SOT89	3.6V 1W zener
3Y9	BZV49-C3V9	Phi	O	SOT89	3.9V 1W zener

### Codes beginning with '4'

Code	Device	Manufacturer	Base	Package	Leaded Equivalent/Data
4 (white)	BAS140W	Sie	I	SOD323	40V 120mA sw schottky
4 (yellow)	BB644	Sie	I	SOD323	Varicap 42-2.5pF
4 (red)	BB57-03W	Sie	I	SOD323	Varicap
4	BB664	Sie	I	SCD80	Varicap 42-2.5pF
41	BAT14-115S	Sie	CS	SOT173	40GHz schottky diode
41	BAT14-115R	Sie	CZ	SOT173	40GHz schottky ring quad
41A	FMMT491A	Zet	N	SOT23	npn 40v 1A max
41D	BAT14-115D	Sie	CY	SOT173	40GHz schottky dual
42	BAT14-025S	Sie	CS	SOT173	4GHz schottky diode
42	BAT14-025R	Sie	CZ	SOT173	4GHz schottky ring quad
42D	BAT14-025D	Sie	CY	SOT173	4GHz schottky dual
43	BAS40	Sie	C	SOT23	schottky diode 40V 100mA
43	DTA143EE	Mot	N	SOT416	pnnp dtr 4k7 + 4k7
43	DTC143XE	Roh	N	EMT3	npn dtr 4k7+10k 50V 100mA
43	DTC143XUA	Roh	N	SC70	npn dtr 4k7+10k 50V 100mA
43	DTC143XKA	Roh	N	SC59	npn dtr 4k7+10k 50V 100mA
43V	PZM43NB	Phi	C	SOT346	43V 0.3W zener
43Y	BZV49-C43	Phi	O	SOT89	43V 1W zener
44	BAS40-04	Sie	D	SOT23	dual series BAS40
44	BAS40-04W	Sie	D	SOT323	dual series BAS40
44	2SC5009	Nec	N	-	npn RF fT 12GHz @3V 5mA
45	BAS40-05	Sie	A	SOT23	dual ca BAS40
45	BAS40-05W	Sie	A	SOT323	dual ca BAS40
45	BAT14-055S	Sie	CS	SOT173	8GHz schottky diode
45	BAT14-055R	Sie	CZ	SOT173	8GHz schottky ring quad
45	DTC124XE	Roh	N	EMT3	npn dtr 22k+47k 50V 50mA
45	DTC124XUA	Roh	N	SC70	npn dtr 22k+47k 50V 50mA
45	DTC124XKA	Roh	N	SC59	npn dtr 22k+47k 50V 50mA
45D	BAT14-055D	Sie	CY	SOT173	8GHz schottky dual
46	BAS40-06	Sie	B	SOT23	dual cc BAS40
46	BAS40-06W	Sie	B	SOT323	dual cc BAS40
46	MBT3946DW	Mot	DP	-	2N3904/2N3906 pair
47	BAS40-07	Sie	S	SOT143	dual BAS40

47	BAS40-07W	Sie	S	SOT343	dual BAS40
47V	PZM47NB	Phi	C	SOT346	47V 0.3W zener
47Y	BZV49-C47	Phi	O	SOT89	47V 1W zener
49	BAT14-095S	Sie	CS	SOT173	18GHz schottky diode
49	BAT14-095R	Sie	CZ	SOT173	18GHz schottky ring quad
49D	BAT14-095D	Sie	CY	SOT173	18GHz schottky dual
413	FMMT413	Zet	N	SOT23	npn avalanche 150v 0.1A
415	FMMT415	Zet	N	SOT23	npn avalanche 260v 0.1A
417	FMMT417	Zet	N	SOT23	npn avalanche 320v 0.1A
431	PZM4.3NB1	Phi	C	SOT346	4.3V 0.3W zener
432	PZM4.3NB2	Phi	C	SOT346	4.3V 0.3W zener
433	PZM4.3NB3	Phi	C	SOT346	4.3V 0.3W zener
449	FMMT449	Zet	N	SOT23	npn 50V 1A low Vce sat
451	FMMT451	Zet	N	SOT23	npn 60V 1A
455	FMMT455	Zet	N	SOT23	NPN 140V 1A
458	FMMT458	Zet	N	SOT23	npn 400V 0.4A
471	PZM4.7NB1	Phi	C	SOT346	4.7V 0.3W zener
472	PZM4.7NB2	Phi	C	SOT346	4.7V 0.3W zener
473	PZM4.7NB3	Phi	C	SOT346	4.7V 0.3W zener
491	FMMT491	Zet	N	SOT23	ZTX 450/451
493	FMMT493	Zet	N	SOT23	ZTX 453
494	FMMT494	Zet	N	SOT23	npn 120V 1A
495	FMMT495	Zet	N	SOT23	npn 170V 1A
497	FMMT497	Zet	N	SOT23	npn 300V 0.5A
4A	MMBV109	Mot	C	SOT23	MV209 varicap
4A	FMMV109	Zet	C	SOT23	MV209 varicap
4A	HD3A	Zet	C	-	75V 100mA sw diode
4A	BC859A	ITT	N	SOT23	BC559A
4Ap	BC859A	Phi	N	SOT23	BC559A
4As	BC859AW	Sie	N	SOT323	BC559A
4As	BC859A	Sie	N	SOT23	BC559A
4A3	PZM4.3NB2A	Phi	A	SOT346	dual ca 4.3V Zener
4A7	PZM4.7NB2A	Phi	A	SOT346	dual ca 4.7V Zener
4AR	BC859AR	Phi	R	SOT23R	BC559A
4B	MMBV432	Mot	B	-	dual cc varicap 1.5-45pF
4B	BC859B	ITT	N	SOT23	BC559B
4Bs	BC859B	Sie	N	SOT23	BC559B
4Bs	BC859BW	Sie	N	SOT323	BC559B
4Bp	BC859B	Phi	N	SOT23	BC559B
4Bt	BC859B	Phi	N	SOT23	BC559B
4Bt	BC859BW	Phi	N	SOT323	BC559B
4B-	BC859BW	Phi	N	SOT323	BC559B
4BR	BC859BR	Phi	R	SOT23R	BC559B
4C	BC859C	ITT	N	SOT23	BC559C
4Cs	BC859C	Sie	N	SOT23	BC559C
4Cs	BC859CW	Sie	N	SOT323	BC559C
4Cp	BC859C	Phi	N	SOT23	BC559C
4Ct	BC859C	Phi	N	SOT23	BC559C
4Ct	BC859CW	Phi	N	SOT323	BC559C
4C-	BC859CW	Phi	N	SOT323	BC559C
4C	MMVB3102	Mot	C	SOT23	varicap 6-35pF
4C	BC859C	Phi	N	SOT23	BC559C
4CR	BC859CR	Phi	R	SOT23R	BC559C
4D	BC859B	Phi	N	SOT23	BC559B
4Dt	BC859W	Phi	N	SOT323	BC559B
4D-	BC859W	Phi	N	SOT323	BC559B
4D	MMBV3401	Mot	C	SOT23	VHF pin diode
4D	HD3A	Zet	C	SOT23	sw diode 75V 100mA
4E	BC860A	Phi	N	SOT23	BC560A
4E	FMMT-A92	Zet	N	SOT23	MPSA92
4E	MMBV105G	Mot	C	SOT23	MV105 varicap
4ER	BC860AR	Phi	R	SOT23R	BC560A
4F	MMBD353	Mot	Z	SOT23	dual MBD101
4F	BC860B	Phi	N	SOT23	BC560B
4F	Gali-4F	MC	AZ	SOT89	DC-4GHz MMIC amp 15 dBm o/p

4Fs	BC860B	Sie	N	SOT23	BC560B
4Fs	BC860BW	Sie	N	SOT323	BC560B
4Fp	BC860B	Phi	N	SOT23	BC560B
4Ft	BC860B	Phi	N	SOT23	BC560B
4Ft	BC860BW	Phi	N	SOT323	BC560B
4F-	BC860BW	Phi	N	SOT323	BC560B
4FR	BC860BR	Phi	R	SOT23	BC560B
4G	MMBV2101	Mot	C	SOT23	MV2101 varicap
4G	BC860C	Phi	N	SOT23	BC560C
4Gs	BC860C	Sie	N	SOT23	BC560C
4Gs	BC860CW	Sie	N	SOT323	BC560C
4Gp	BC860C	Phi	N	SOT23	BC560C
4Gt	BC860C	Phi	N	SOT23	BC560C
4Gt	BC860CW	Phi	N	SOT323	BC560C
4G-	BC860CW	Phi	N	SOT323	BC560C
4GR	BC860CR	Phi	R	SOT23	BC560CR
4H	MMBV2103	Mot	C	SOT23	MV2103 varicap
4Hp	BC860	Phi	N	SOT23	BC560
4Ht	BC860W	Phi	N	SOT323	BC560
4H-	BC860W	Phi	N	SOT323	BC560
4J	FMMT38A	Zet	N	SOT23	BCX38A
4J	MMBV2109	Mot	C	SOT23	MV2109 varicap
4K	BAP64-04	Phi	D	-	dual series 3GHz pin diode
4K	MMSB3000	Mot	I	SOD123	Si diode 30V 0.2A
4L	BAP50-04	Phi	D	-	dual series GP RF pin diode
4M	MMBD101	Mot	C	SOT23	MBD101 schottky diode
4Ms	BAT240A	Sie	EQ	SOT143	dual schottky 250V 0.4A
4R	MMBV3700	Mot	C	SOT23	200V vhf pin diode
4S	MMBD201	Mot	C	SOT23	MBD201
4T	MMBD301	Mot	C	SOT23	MBD301 UHF schottky diode
4U	MMBV2105	Mot	C	SOT23	MV2105 varicap
4V	MMBV2106	Mot	C	SOT23	MV2106 varicap
4V	BCW65AR	Zet	R	SOT23R	npn 32V 0.8A
4V3	PZM4.3NB	Phi	C	SOT346	4.3V 0.3W zener
4V7	PZM4.7NB	Phi	C	SOT346	4.7V 0.3W zener
4W	MMBV2107	Mot	C	SOT23	MV2107 varicap
4W	BCW67AR	Zet	R	SOT23R	pnp 32V 0.8A
4Y	MMBV2102	Mot	C	SOT23	MV2102 varicap
4Y3	BZV49-C4V3	Phi	O	SOT89	4.3V 1W zener
4Y7	BZV49-C4V7	Phi	O	SOT89	4.7V 1W zener
4X	MMBV2108	Mot	C	SOT23	MV2108 varicap
4Z	MMBV2104	Mot	C	SOT23	MV2104 varicap

### Codes beginning with '5'

Code	Device	Manufacturer	Base	Package	Leaded Equivalent/Data
5 (white)	BAT60B	Sie	I		10V 3A sw Schottky
5 (red)	BBY57-03W	Sie	I	SOD323	varicap
500	SSTPAD500	Sil	J		PAD-500 500pA leakage diode
51	BAT15-115S	Sie	CS	SOT173	40GHz schottky diode
51	BAT15-115R	Sie	CZ	SOT173	40GHz schottky ring quad
51D	BAT15-115D	Sie	CY	SOT173	40GHz schottky dual
51V	PZM51NB	Phi	C	SOT346	51V 0.3W zener
51Y	BZV49-C51	Phi	O	SOT89	51V 1W zener
52	BAT15-025S	Sie	CS	SOT173	4GHz schottky diode
52	BAT15-025R	Sie	CZ	SOT173	4GHz schottky ring quad
52	Gali-52	MC	AZ	SOT89	DC-2GHz MMIC amp 23 dB gain
52	BAS52-02V	Inf	I	SC79	Schottky diode 45V 750mA
52	DTA123YE	Roh	N	EMT3	pnp dtr 2k2 +10k 50V 100mA
52	DTA123YUA	Roh	N	SC70	pnp dtr 2k2 +10k 50V 100mA
52	DTA123YKA	Roh	N	SC59	pnp dtr 2k2 +10k 50V 100mA
52D	BAT15-025D	Sie	CY	SOT173	4GHz schottky dual
53s	BAT17	Sie	C	SOT23	schottky diode 4V 100mA
54	DTA114YE	Roh	N	EMT3	pnp dtr 10k + 47k 50V 100mA

54	DTA114YUA	Roh	N	SC70	pnp dtr 10k + 47k 50V 100mA
54	DTA114YKA	Roh	N	SC59	pnp dtr 10k + 47k 50V 100mA
54s	BAT17-04	Sie	D	SOT23	dual series BAT17
54s	BAT17-04W	Sie	D	SOT323	dual series BAT17
55	BAT15-055S	Sie	CS	SOT173	8GHz schottky diode
55	BAT15-055R	Sie	CZ	SOT173	8GHz schottky ring quad
55	Gali-55	MC	AZ	SOT89	DC-4GHz MMIC amp 21 dB gain
55D	BAT15-055D	Sie	CY	SOT173	8GHz schottky dual
55s	BAT17-05	Sie	A	SOT23	dual ca BAT17
55s	BAT17-05W	Sie	A	SOT323	dual ca BAT17
56s	BAT17-06	Sie	B	SOT23	dual cc BAT17
56s	BAT17-06W	Sie	B	SOT323	dual cc BAT17
56V	PZM56NB	Phi	C	SOT346	56V 0.3W zener
56Y	BZV49-C56	Phi	O	SOT89	56V 1W zener
57s	BAT17-07	Sie	S	SOT143	dual BAT17
57	BFQ57	Sie	CX	SOT173	npn 6.5GHz 16V/35mA
58	BFQ58	Sie	CX	SOT173	npn 6.5GHz 16V/30mA
59	BAT15-095S	Sie	CS	SOT173	18GHz schottky diode
59	BAT15-095R	Sie	CZ	SOT173	18GHz schottky ring quad
59D	BAT15-095D	Sie	CY	SOT173	18GHz schottky dual
511	PZM5.1NB1	Phi	C	SOT346	5.1V 0.3W zener
512	PZM5.1NB2	Phi	C	SOT346	5.1V 0.3W zener
513	PZM5.1NB3	Phi	C	SOT346	5.1V 0.3W zener
561	PZM5.1NB1	Phi	C	SOT346	5.6V 0.3W zener
562	PZM5.1NB2	Phi	C	SOT346	5.6V 0.3W zener
563	PZM5.1NB3	Phi	C	SOT346	5.6V 0.3W zener
558	FMMT558	Zet	N	SOT23	pnp 400V 0.15A
589	FMMT589	Zet	N	SOT23	pnp 30V 1A
591	FMMT591	Zet	N	SOT23	ZTX550/551
593	FMMT593	Zet	N	SOT23	ZTX 553
5A	BC807-16	Phi	N	SOT23	BC327-16
5As	BC807-16	Sie	N	SOT23	BC327-16
5As	BC807-16W	Sie	N	SOT323	BC327-16
5Ap	BC807-16	Phi	N	SOT23	BC327-16
5At	BC807-16	Phi	N	SOT23	BC327-16
5At	BC807-16W	Phi	N	SOT323	BC327-16
5A-	BC807-16W	Phi	N	SOT323	BC327-16
5A	BSS123	Mot	M	SOT23	n-ch tmosfet Vds 100V
5A	MMBD6050	Mot	C	SOT23	sw diode 70V 0.2A
5A	FMMD6050	Zet	C	SOT23	sw diode 70V 100mA
5A1	PZM5.1NB2A	Phi	A	SOT346	dual ca 5.1V 0.3W zener
5A6	PZM5.6NB2A	Phi	A	SOT346	dual ca 5.6V 0.3W zener
5AR	BC807-16R	Phi	R	SOT23R	BC327-16
5B	MMBT4123	Mot	N	SOT23	2N4123
5B	BC807-25	SGS	N	SOT23	BC327-25
5Bs	BC807-25	Sie	N	SOT23	BC327-25
5Bs	BC807-25W	Sie	N	SOT323	BC327-25
5Bs	BC807-25U	Sie	N	SC74	BC327-25
5Bp	BC807-25	Phi	N	SOT23	BC327-25
5Bt	BC807-25	Phi	N	SOT23	BC327-25
5Bt	BC807-25W	Phi	N	SOT323	BC327-25
5B-	BC807-25W	Phi	N	SOT323	BC327-25
5B	MMBD6100	Mot	B	SOT23	cc dual diode 70V 0.2A
5B	FMMD6100	Zet	B	SOT23	cc dual diode 70V 0.2A
5BM	MMBD6100	Mot	B	SOT23	cc dual diode 70V 0.2A
5BR	BC807-25R	Phi	R	SOT23R	BC327-25
5C	BC807-40	SGS	N	SOT23	BC327-40
5Cs	BC807-40	Sie	N	SOT23	BC327-40
5Cs	BC807-40W	Sie	N	SOT323	BC327-40
5Cp	BC807-40	Phi	N	SOT23	BC327-40
5Ct	BC807-40	Phi	N	SOT23	BC327-40
5Ct	BC807-40W	Phi	N	SOT323	BC327-40
5C-	BC807-40W	Phi	N	SOT323	BC327-40
5C	MMBD7000	Mot	D	SOT23	2 ser diodes 100V 0.2A
5C	FMMD7000	Zet	D	SOT23	2 ser diodes 70V 200mA

<b>5CR</b>	BC807-40R	Phi	R	SOT23E	BC327-40
<b>5D</b>	FMMD914	Zet	C	SOT23	1N914
<b>5D</b>	MMBD914	Mot	C	SOT23	1N914
<b>5D</b>	MMSD914	Mot	I	SOD123	1N914
<b>5D</b>	HD2A	Zet	B		dual cc HD2 75V 100mA
<b>5Dp</b>	BC807	Phi	N	SOT23	BC327
<b>5Dt</b>	BC807	Phi	N	SOT23	BC327
<b>5Dt</b>	BC807W	Phi	N	SOT323	BC327
<b>5D-</b>	BC807W	Phi	N	SOT323	BC327
<b>5E</b>	BC808-16	Phi	N	SOT23	BC328-16
<b>5Es</b>	BC808-16	Sie	N	SOT23	BC328-16
<b>5Es</b>	BC808-16W	Sie	N	SOT323	BC328-16
<b>5E</b>	FMMT-A43R	Zet	R	SOT23R	MPSA43
<b>5E</b>	BC808-16	Phi	N	SOT23	BC328-16
<b>5ER</b>	BC808-16R	Phi	R	SOT23R	BC328-16
<b>5F</b>	BC808-25	Phi	N	SOT23	BC328-25
<b>5Fs</b>	BC808-25	Sie	N	SOT23	BC328-25
<b>5Fs</b>	BC808-25W	Sie	N	SOT323	BC328-25
<b>5F</b>	MMBD501	Mot	C	SOT23	MBD501 hot carrier diode
<b>5F</b>	Gali-5F	MC	AZ	SOT89	DC-4GHz MMIC amp 20 dB gain
<b>5FR</b>	BC808-25R	Phi	R	SOT23R	BC328-25
<b>5G</b>	BC808-40	Phi	N	SOT23	BC328-40
<b>5Gs</b>	BC808-40	Sie	N	SOT23	BC328-40
<b>5Gs</b>	BC808-40W	Sie	N	SOT323	BC328-40
<b>5G</b>	MMBD353	Mot	D		dual series MBD101
<b>5GR</b>	BC808-40R	Phi	R	SOT23R	BC328-40
<b>5H</b>	MMBD701	Mot	C	SOT23	MBD701 UHF schottky diode
<b>5Hp</b>	BC808	Phi	N	SOT23	BC328
<b>5HZ</b>	BC808	Zet	N	SOT23	BC328
<b>5H</b>	MMBD4148	Nat	C	SOT23	1N4148
<b>5I</b>	MMSD4148	Mot	C		1N4148
<b>5J</b>	FMMT38B	Zet	N		BCX38B
<b>5K</b>	MMBV809	Mot	C	SOT23	Hyperabrupt varicap
<b>5Kp</b>	BAP64-05	Phi	B		dual cc 3GHz RF pin diode
<b>5L</b>	MMBV609	Mot	B	SOT23	dual cc Hyperabrupt varicap
<b>5N</b>	MMBD452L	Mot	D	SOT23	series UHF schottky diodes
<b>5P</b>	FMMT2907AR	Zet	R	SOT23R	2N2907A
<b>5T</b>	BCW66GR	Sie	R	SOT23R	nnp 45V 0.8A 350mW
<b>5V</b>	BCW65BR	Zet	R	SOT23R	nnp 32V 0.8A
<b>5V1</b>	PZM5.1NB	Phi	C	SOT346	5.1V 0.3W zener
<b>5V6</b>	PZM5.6NB	Phi	C	SOT346	5.6V 0.3W zener
<b>5W</b>	BCW67BR	Zet	R	SOT23R	pnp 32V 0.8A
<b>5Y1</b>	BZV49-C5V1	Phi	O	SOT89	5.1V 1W zener
<b>5Y6</b>	BZV49-C5V6	Phi	O	SOT89	5.6V 1W zener

### Codes beginning with '6'

Code	Device	Manufacturer	Base	Package	Leaded Equivalent/Data
<b>6 (red)</b>	BBY56-03W	Sie	I	SOD323	varicap
<b>60s</b>	BAR60	Sie	QQ	SOT143	3 pin diodes
<b>605</b>	NDS0605	Fch	M	SOT23	P-ch mosfet 60V 180mA
<b>61s</b>	BAR61	Sie	PQ	SOT143	3 pin diodes pi atten
<b>61A</b>	MMBF4117	Nat	F	-	n-ch jfet ultra low i/p Ig
<b>61C</b>	MMBF4118	Nat	F	-	n-ch jfet ultra low i/p Ig
<b>61A</b>	MMBF4119	Nat	F	-	n-ch jfet ultra low i/p Ig
<b>61J</b>	MMBF4091	Nat	F	-	n-ch jfet sw/chopper
<b>61K</b>	MMBF4092	Nat	F	-	n-ch jfet sw/chopper
<b>61L</b>	MMBF4093	Nat	F	-	n-ch jfet sw/chopper
<b>61M</b>	MMBF4859	Nat	F	-	n-ch jfet sw/chopper
<b>61N</b>	MMBF5514	Nat	F	-	p-ch jfet sw/chopper
<b>61P</b>	MMBF5115	Nat	F	-	p-ch jfet sw/chopper
<b>61Q</b>	MMBF5516	Nat	F	-	p-ch jfet sw/chopper
<b>61S</b>	MMBF5458	Nat	F	-	n-ch jfet gp 2N5458
<b>61T</b>	MMBF5459	Nat	F	-	n-ch jfet gp 2N5459

61U	MMBF5461	Nat	F	-	p-ch jfet gp 2N5461
61V	MMBF5462	Nat	F	-	p-ch jfet gp 2N5462
62	DTC123YE	Roh	N	EMT3	npn dtr 2k2 +10k 50V 100mA
62	DTC123YUA	Roh	N	SC70	npn dtr 2k2 +10k 50V 100mA
62	DTC123YKA	Roh	N	SC59	npn dtr 2k2 +10k 50V 100mA
62P	MMBFJ201	Nat	F	-	n-ch jfet gp J201
62Q	MMBFJ202	Nat	F	-	n-ch jfet gp J202
62R	MMBFJ203	Nat	F	-	n-ch jfet gp J203
62S	MMBFJ270	Nat	F	-	p-ch jfet gp J270
62T	MMBFJ271	Nat	F	-	p-ch jfet gp J271
62V	PZM62NB1	Phi	C	SOT346	62V 0.3W zener
62Y	BZV49-C62	Phi	O	SOT89	62V 1W zener
63s	BAT64	Sie	C	SOT23	Schottky 40V 250mA gp
63s	BAT64W	Sie	C	SOT323	Schottky 40V 250mA gp
63Q	MMBFJ304	Nat	F	-	n-ch jfet vhf J304
64	DTC114YE	Roh	N	EMT3	npn dtr 10k + 47k 50V 100mA
64	DTC114YUA	Roh	N	SC70	npn dtr 10k + 47k 50V 100mA
64	DTC114YKA	Roh	N	SC59	npn dtr 10k + 47k 50V 100mA
64s	BAT64-04	Sie	D	SOT23	dual ser gp Schottky 40V 250mA
64s	BAT64-04W	Sie	D	SOT323	dual ser gp Schottky 40V 250mA
65s	BAT64-05	Sie	B	SOT23	dual cc gp Schottky 40V 250mA
65s	BAT64-05W	Sie	B	SOT323	dual cc gp Schottky 40V 250mA
66s	BAT64-06	Sie	A	SOT23	dual ca gp Schottky 40V 250mA
66s	BAT64-06W	Sie	A	SOT323	dual ca gp Schottky 40V 250mA
67s	BAT64-07	Sie	S	SOT143	dual gp Schottky 40V 250mA
67s	BAT64-07W	Sie	S	SOT343	dual gp Schottky 40V 250mA
67	BFP67	Tfk	X	-	npn Rf ft 7.5GHz 10V 50mA
67R	BFP67R	Tfk	WQ	-	npn Rf ft 7.5GHz 10V 50mA
68Y	BZV49-C68	Phi	O	SOT89	68V 1W zener
68V	PZM68NB1	Phi	C	SOT346	68V 0.3W zener
69	DTA114YE	Mot	N	SOT416	pnp dtr 10k +47k
69	DTC115EE	Roh	N	EMT3	npn dtr 100k+100k 50V 20mA
69	DTC115EUA	Roh	N	SC70	npn dtr 100k+100k 50V 20mA
69	DTC115EKA	Roh	N	SC59	npn dtr 100k+100k 50V 20mA
605	NDS0605	Fch	M	-	p-ch sw mosfet 60V
610	NDS0610	Fch	M	-	p-ch sw mosfet 60V
614	FMMT614	Zet	N	SOT23	sw
617	FMMT617	Zet	N	SOT23	npn sw 15V 3A
618	FMMT618	Zet	N	SOT23	npn sw 20V 2.5A
619	FMMT619	Zet	N	SOT23	npn sw 50V 2A
621	PZM6.2NB1	Phi	C	SOT346	6.2V 0.3W zener
622	PZM6.2NB2	Phi	C	SOT346	6.2V 0.3W zener
623	PZM6.2NB3	Phi	C	SOT346	6.2V 0.3W zener
624	FMMT624	Zet	N	SOT23	-
625	FMMT625	Zet	N	SOT23	-
634	FMMT634	Zet	N	SOT23	100V 0.9A darlington npn
651	PZT651	Mot	N	SOT223	npn 60V 1A
681	PZM6.8NB1	Phi	C	SOT346	6.8V 0.3W zener
682	PZM6.8NB2	Phi	C	SOT346	6.8V 0.3W zener
683	PZM6.8NB1	Phi	C	SOT346	6.8V 0.3W zener
6A	MMBF4416	Mot	F	SOT23	2N4416 n-ch vhf jfet
6A	MUN2111	Mot	N	SOT23	pnp dtr with 10k+10k
6A	MUN5111	Mot	N	SOT323	pnp dtr with 10k+10k
6A	BC817-16	Phi	N	SOT23	BC337-16
6As	BC817-16	Sie	N	SOT23	BC337-16
6As	BC817-16	Sie	N	SOT323	BC337-16
6Ap	BC817-16W	Phi	N	SOT23	BC337-16
6At	BC817-16	Phi	N	SOT23	BC337-16
6At	BC817-16W	Phi	N	SOT323	BC337-16
6A-	BC817-16W	Phi	N	SOT323	BC337-16
6A2	PZM6.2NB2A	Phi	A	SOT346	dual ca 6.2V 0.3W zener
6A8	PZM6.8NB2A	Phi	A	SOT346	dual ca 6.8V 0.3W zener
6AR	BC817-16R	Phi	R	SOT23	BC337-16
6AZ	BC817-16	Zet	N	SOT23	BC337-16
6B	MMBF5484	Mot	F	SOT23	n-ch jfet 2N5484

<b>6B</b>	BC817-25	Phi	N	SOT23	BC337-25
<b>6Bs</b>	BC817-25	Sie	N	SOT23	BC337-25
<b>6Bs</b>	BC817-25W	Sie	N	SOT323	BC337-25
<b>6Bp</b>	BC817-25	Phi	N	SOT23	BC337-25
<b>6Bt</b>	BC817-25	Phi	N	SOT23	BC337-25
<b>6Bt</b>	BC817-25W	Phi	N	SOT323	BC337-25
<b>6B-</b>	BC817-25W	Phi	N	SOT323	BC337-25
<b>6B</b>	MUN2112	Mot	N	SOT23	pnnp dtr 22k+22k
<b>6B</b>	MUN5112	Mot	N	SOT323	MUN2112
<b>6BR</b>	BC817-25R	Phi	R	SOT23R	BC337-25
<b>6BZ</b>	BC817-25	Zet	N	SOT23	BC337-25
<b>6C</b>	BC817-40	Phi	N	SOT23	BC337-40
<b>6Cs</b>	BC817-40	Sie	N	SOT23	BC337-40
<b>6Cs</b>	BC817-40W	Sie	N	SOT323	BC337-40
<b>6Cp</b>	BC817-40	Phi	N	SOT23	BC337-40
<b>6Ct</b>	BC817-40	Phi	N	SOT23	BC337-40
<b>6Ct</b>	BC817-40W	Phi	N	SOT323	BC337-40
<b>6C-</b>	BC817-40W	Phi	N	SOT323	BC337-40
<b>6C</b>	MMBFU310	Mot	F	SOT23	n-ch jfet U310
<b>6C</b>	MUN2113	Mot	N	SOT23	pnnp dtr 47k+47k
<b>6C</b>	MUN5113	Mot	N	SOT323	MUN2113
<b>6CR</b>	BC817-40R	Phi	R	SOT23R	BC337-40
<b>6CZ</b>	BC817-40	Zet	N	SOT23	BC337-40
<b>6Dp</b>	BC817	Phi	N	SOT23	BC337
<b>6Dt</b>	BC817	Phi	N	SOT23	BC337
<b>6Dt</b>	BC817W	Phi	N	SOT323	BC337
<b>6D-</b>	BC817W	Phi	N	SOT323	BC337
<b>6D</b>	MMBF5457	Mot	F	SOT23	2N5457 n-ch jfet
<b>6D</b>	MUN2114	Mot	N	SOT23	pnnp dtr 10k+47k
<b>6D</b>	MUN5114	Mot	N	SOT323	MUN2114
<b>6DZ</b>	BC817	Zet	N	SOT23	BC337
<b>6E</b>	FMMT-A93R	Zet	R	SOT23R	MPSA93
<b>6E</b>	MMBF5460	Mot	F	SOT23	p-ch jfet 2N5460
<b>6E</b>	BC818-16	Phi	N	SOT23	BC338-16
<b>6Es</b>	BC818-16	Sie	N	SOT23	BC338-16
<b>6Es</b>	BC818-16W	Sie	N	SOT323	BC338-16
<b>6E</b>	MUN2115	Mot	N	SOT23	pnnp dtr R1 10k
<b>6E</b>	MUN5115	Mot	N	SOT323	MUN2115
<b>6ER</b>	BC818-16R	Phi	R	SOT23	BC338-16
<b>6EZ</b>	BC818-16	Zet	N	SOT23	BC338-16
<b>6F</b>	MMBF4860	Mot	F	SOT23	2N4860 n-ch jfet
<b>6F</b>	BC818-25	Phi	N	SOT23	BC338-25
<b>6Fs</b>	BC818-25	Sie	N	SOT23	BC338-25
<b>6Fs</b>	BC818-25W	Sie	N	SOT323	BC338-25
<b>6F</b>	MUN2116	Mot	N	SOT23	pnnp dtr R1 4k7
<b>6F</b>	MUN5116	Mot	N	SOT323	MUN2116
<b>6F</b>	Gali-6F	MC	AZ	SOT89	DC-4GHz MMIC amp 12 dB gain
<b>6FR</b>	BC818-25R	Phi	R	SOT23R	BC338-25
<b>6FZ</b>	BC818-25	Zet	N	SOT23	BC338-25
<b>6G</b>	BC818-40	Phi	N	SOT23	BC338-40
<b>6Gs</b>	BC818-40	Sie	N	SOT23	BC338-40
<b>6Gs</b>	BC818-40W	Sie	N	SOT323	BC338-40
<b>6G</b>	MMBF4393	Mot	F	SOT23	n-ch jfet 2N4393
<b>6G</b>	MUN2130	Mot	N	SOT23	pnnp dtr 1k0+1k0
<b>6G</b>	MUN5130	Mot	N	SOT323	ial">MUN2130
<b>6GR</b>	BC818-40R	Phi	R	SOT23	BC338-40
<b>6GZ</b>	BC818-40	Zet	N	SOT23	BC338-40
<b>p6G</b>	PMBF4393	Phi	F	SOT23	n-ch jfet 2N4393
<b>6Hp</b>	BC818	Phi	N	SOT23	BC338
<b>6HZ</b>	BC818	Zet	N	SOT23	BC338
<b>6H</b>	MMBF5486	Mot	F	SOT23	n-ch jfet 2N5486
<b>6H</b>	MUN2131	Mot	N	SOT23	pnnp dtr 2k2 +2k2
<b>6H</b>	MUN5131	Mot	N	SOT323	MUN2121
<b>6J</b>	MMBF4391	Mot	F	SOT23	n-ch jfet 2N4391
<b>6J</b>	MUN2132	Mot	N	SOT23	pnnp dtr 4k7+ 4k7

<b>6J</b>	MUN5132	Mot	N	SOT323	MUN2132
<b>p6J</b>	MMBF4391	Phi	F	SOT23	n-ch jfet 2N4391
<b>6K</b>	MMBF4932	Mot	F	SOT23	n-ch jfet 2N4932
<b>6K</b>	MUN2133	Mot	N	SOT23	pnp dtr 4k7+ 47k
<b>6K</b>	MUN5133	Mot	N	SOT323	MUN2133
<b>p6K</b>	MMBF4932	Phi	F	SOT23	n-ch jfet 2N4932
<b>6L</b>	MMBF5459	Mot	F	SOT23	n-ch jfet 2N5459
<b>6L</b>	MUN2134	Mot	N	SOT23	pnp dtr 22k+47k
<b>6L</b>	MUN5134	Mot	N	SOT323	MUN2134
<b>6M</b>	MMBF5485	Nat	F	SOT23	n-ch jfet vhf 2N5485
<b>6N</b>	MMBF4861	Nat	F	SOT23	n-ch jfet sw/chopper
<b>6Q</b>	MMBFJ305	Nat	F	-	n-chjfet vhf J305
<b>6P</b>	MMBFJ111	Nat	F	-	J111 n-ch jfet
<b>6P</b>	BCX71HR	Phi	R	SOT23R	BCX79
<b>6R</b>	MMBFJ112	Nat	F	-	J112 n-chjfet
<b>6P</b>	MMBFJ113	Nat	F	-	J113 n-ch jfet
<b>6S</b>	MMBFJ176	Nat	F	-	J176 n-ch jfet
<b>6S</b>	MMSD71	Mot	C	-	gp Si diode
<b>p6S</b>	PMBFJ176	Phi	F	-	J176 n-ch jfet
<b>6T</b>	BCW68GR	Sie	R	-	pnp 45V 0.8A 350mW
<b>6T</b>	MMBFJ310	Mot	F	SOT23	uhf n-ch jfet J310
<b>6U</b>	MMBFJ309	Nat	F	SOT23	uhf n-ch jfet J309
<b>6V</b>	BCW65CR	Zet	R	SOT23R	nnp 32V 0.8A
<b>6V</b>	MMBFJ174	Nat	F	-	J174 p-ch jfet sw/chopper
<b>6V2</b>	PZM6.2NB	Phi	C	SOT346	6.2V 0.3W zener
<b>6V8</b>	PZM6.8NB	Phi	C	SOT346	6.8V 0.3W zener
<b>6W</b>	BCW67CR	Zet	R	SOT23R	pnp32V 0.8A
<b>6W</b>	MMBFJ175	Mot	F	SOT23	J175 p-ch jfet
<b>p6W</b>	PMBFJ175	Phi	F	SOT23	J175 p-ch jfet
<b>6X</b>	MMBFJ174	Nat	F	-	J174 p-ch jfet sw/chopper
<b>p6X</b>	PMBFJ174	Phi	F	-	J174 p-ch jfet sw/chopper
<b>6Y</b>	MMBFJ177	Mot	F	SOT23	J177 p-ch jfet
<b>p6Y</b>	PMBFJ177	Phi	F	SOT23	J177 p-ch jfet
<b>6Y2</b>	BZV49-C6V2	Phi	O	SOT89	6.2V 1W zener
<b>6Y8</b>	BZV49-C6V8	Phi	O	SOT89	6.8V 1W zener
<b>6Z</b>	MMBF170	Mot	M	SOT23	tmosfet n-ch Vds 60V

### Codes beginning with '7'

Code	Device	Manufacturer	Base	Package	Leaded Equivalent/Data
<b>7 (white)</b>	BBY55-02W	Sie	I	SCD80	UHF Varicap
<b>70</b>	BFQ70	Sie	CX	SOT173	nnp fT 5.2GHz 15V 35mA
<b>71</b>	BFQ71	Sie	CX	SOT173	nnp fT 5.2GHz 15V 30mA
<b>72</b>	BFQ72	Sie	CX	SOT173	nnp fT 5.1GHz 15V 50mA
<b>72</b>	2N7002	Sil	M	SOT23	n-ch mosfet 60V 170mA
<b>73s</b>	BAS70	Sie	C	SOT23	schottky diode 70V 50mA
<b>73p</b>	BAS70	Phi	C	SOT23	schottky diode 70V 50mA
<b>73t</b>	BAS70	Phi	C	SOT23	schottky diode 70V 50mA
<b>73t</b>	BAS70W	Phi	C	SOT323	schottky diode 70V 50mA
<b>73-</b>	BAS70W	Phi	C	SOT323	schottky diode 70V 50mA
<b>73</b>	MA4CS101A	M/A	C	SOT23	schottky diode 70V 50mA
<b>73</b>	BFQ73	Sie	CX	SOT173	nnp fT 4.9GHz 15V 75mA
<b>73</b>	2SC5004	Nec	N	-	nnp RF 5GHz @5V 5mA
<b>73S</b>	BFQ73S	Sie	CX	SOT173	nnp fT 5.3GHz 15V 100mA
<b>74</b>	BFQ74	Sie	CX	SOT173	nnp fT 6GHz 16V 35mA
<b>74s</b>	BAS70-04	Sie	D	SOT23	dual series BAS70
<b>74p</b>	BAS70-04	Phi	D	SOT23	dual series BAS70
<b>74t</b>	BAS70-04	Phi	D	SOT23	dual series BAS70
<b>74t</b>	BAS70-04W	Phi	D	SOT323	dual series BAS70
<b>74t</b>	BAS70-04W	Phi	D	SOT323	dual series BAS70
<b>74</b>	MA4CS101B	M/A	D	SOT23	dual series MA4CS101A (73)
<b>74</b>	DTA114WE	Rho	N	EMT3	pnp dtr 10k + 4k7 50V 100mA
<b>74</b>	DTA114WUA	Rho	N	SC70	pnp dtr 10k + 4k7 50V 100mA
<b>74</b>	DTA114WKA	Rho	N	SC59	pnp dtr 10k + 4k7 50V 100mA



74	2SC5005	Nec	N	-	npn RF 5.5GHz @5V 5mA
75s	BAS70-05	Sie	B	SOT23	dual cc BAS70
75s	BAS70-05W	Sie	B	SOT323	dual cc BAS70
75p	BAS70-05	Phi	B	SOT23	dual cc BAS70
75t	BAS70-05W	Phi	B	SOT323	dual cc BAS70
75t	BAS70-05	Phi	B	SOT23	dual cc BAS70
75-	BAS70-05W	Phi	B	SOT323	dual cc BAS70
75	BFQ75	Sie	CX	SOT173	pnnp fT 5GHz 12V 50mA
75Y	BZV49-C75	Phi	O	SOT89	75V 1W zener
76s	BAS70-06	Sie	A	SOT23	dual ca BAS70
76p	BAS70-06	Phi	A	SOT23	dual ca BAS70
76t	BAS70-06	Phi	A	SOT23	dual ca BAS70
76t	BAS70-06W	Phi	A	SOT323	dual ca BAS70
76-	BAS70-06W	Phi	A	SOT323	dual ca BAS70
76	BFQ76	Sie	CX	SOT173	pnnp fT 5GHz 15V 30mA
76	DTA144WE	Rho	N	EMT3	pnnp dtr 47k + 22k 50V 30mA
76	DTA144WUA	Rho	N	SC70	pnnp dtr 47k + 22k 50V 30mA
76	DTA144WKA	Rho	N	SC59	pnnp dtr 47k + 22k 50V 30mA
77s	BAS70-07	Sie	S	SOT143	dual BAS70
77s	BAS70-07	Sie	S	SOT343	dual BAS70
77	MA4CS101E	M/A	S	SOT143	dual MA4CS101A (73)
77	BFQ77	Sie	CX	SOT173	npn fT 7GHz 15V 20mA
78	MMBT4258	Nat	N	SOT23	pnnp sw fT 700MHz
701	2N7001	Mot	M	SOT23	n-ch mosfet
702	2N7002	Mot	M	SOT23	n-ch mosfet 60V 0.11A
703	2N7003	Mot	M	SOT23	n-ch mosfet
712	NDS7002A	Nat	M	SOT23	n-ch mosfet 60V 0.28A
717	FMMT717	Zet	N	SOT23	pnnp sw 0.625W 2.5A 12V
718	FMMT718	Zet	N	SOT23	pnnp sw 0.625W 1.5A 20V
720	FMMT720	Zet	N	SOT23	pnnp sw 0.625W 1.5A
722	FMMT722	Zet	N	SOT23	pnnp sw
723	FMMT723	Zet	N	SOT23	pnnp sw
751	PZM7.5NB1	Phi	C	SOT346	7.5V 0.3W zener
752	PZM7.5NB2	Phi	C	SOT346	7.5V 0.3W zener
753	PZM7.5NB3	Phi	C	SOT346	7.5V 0.3W zener
7A	MMBR901	Mot	N	SOT23	npn RF MRF901
7A	MUN5211DW1	Mot	DN	SOT363	dual npn dtr 10k+10k
7A5	PZM7.5NB2A	Phi	A	SOT346	dual ca 7.5V 0.3W zener
7B	MMBR920	Mot	N	SOT23	npn RF ?MRF920
7B	MUN5212DW1	Mot	DN	SOT363	dual npn dtr 22k+22k
7C	MMBR930	Mot	N	SOT23	npn RF ?MRF930
7C	MUN5213DW1	Mot	DN	SOT363	dual npn dtr 47k+47k
7D	MMBR931	Mot	N	SOT23	npn RF ?MRF931
7D	HD4A	Zet	A	-	ca dual HD3A
7D	MUN5214DW1	Mot	DN	SOT363	dual npn dtr 10k+47k
7E	FMMT-A42R	Zet	R	-	MPSA42
7E	MMBR2060	Mot	N	-	npn RF fT 1GHz Vce 30V 50mA
7E	MUN5215DW1	Mot	DN	SOT363	dual npn 10k base res
7F	MMBR4957	Mot	N	-	npn RF fT 1.2GHz 30V 30mA
7F	MUN5211DW1	Mot	DN	SOT363	dual npn dtr R1 4k7
7G	MMBR5031	Mot	N	SOT23	npn RF fT 1GHz 10V 20mA
7G	MUN5230DW1	Mot	DN	SOT363	dual npn dtr 1k0+1k0
7H	MMBR5179	Mot	N	SOT23	npn RF 2N5179/BFY90
7H	MUN5231DW1	Mot	DN	SOT363	dual npn dtr 2k2+2k2
7J	FMMT38C	Zet	N	SOT23	BCX38C
7J	MUN5232DW1	Mot	DN	SOT363	dual npn dtr 4k7+4k7
7K	MMBR2857	Mot	N	-	npn RF fT 1GHz Vce 15V 40mA
7K	MUN5233DW1	Mot	DN	SOT363	dual npn dtr 4k7+47k bias
7L	MUN5234DW1	Mot	DN	SOT3636	dual npn dtr 22k+47k bias
7M	MUN5235DW1	Mot	DN	SOT363	dual npn dtr 2k2+47k bias
7M	MMBR521L	Mot	N	SOT23	pnnp RF MRF521
7M	BCW66HR	Zet	R	SOT23R	npn 45V 0.8A
7N	MMBR941BL	Mot	N	SOT23	npn RF fT 8GHz MRF941
7N	BCW68HR	Zet	R	SOT23	pnnp 45V 0.8A
7P	BCW66FR	SGS	R	SOT23R	npn 45V 0.8A 350mW

<b>7P</b>	MMBR911L	Mot	N	SOT23	npn RF ft 6GHz MRF911
<b>7R</b>	MMBR536	Mot	N	-	npn RF MRF536
<b>7T</b>	BCW68FR	Zet	R	SOT23R	pnnp 45V 0.8A
<b>7V5</b>	PZM7.5NB	Phi	C	SOT346	7.5V 0.3W zener
<b>7X</b>	MMBR571L	Mot	N	SOT23	npn RF ft 8GHz MRF571
<b>7Y</b>	MMBR941L	Mot	N	SOT23	npn RF ft 8GHz MRF941
<b>7Y5</b>	BZV49-C7V5	Phi	O	SOT89	7.5V 1W zener
<b>7Z</b>	MMBR951L	Mot	N	SOT23	npn RF ft7.5GHz MRF951

### Codes beginning with '8'

Code	Device	Manufacturer	Base	Package	Leaded Equivalent/Data
<b>8 (yellow)</b>	BBY58-03W	Sie	I	SOD323	varicap
<b>81</b>	ZMV831BV2	Zet	I	SOD523	28V hyperabrupt varicap 15pF @2V
<b>81A</b>	MMBZ5250B	Mot	C	SOT23	20V zener 0.225W
<b>81A</b>	PMBZ5250B	Phi	C	SOT23	20V zener 0.225W
<b>81B</b>	MMBZ5251B	Mot	C	SOT23	22V zener 0.225W
<b>81B</b>	PMBZ5251B	Phi	C	SOT23	22V zener 0.225W
<b>81C</b>	MMBZ5252B	Mot	C	SOT23	24V zener 0.225W
<b>81C</b>	PMBZ5252B	Phi	C	SOT23	24V zener 0.225W
<b>81D</b>	MMBZ5253B	Mot	C	SOT23	25V zener 0.225W
<b>81D</b>	PMBZ5253B	Phi	C	SOT23	25V zener 0.225W
<b>81E</b>	MMBZ5254B	Mot	C	SOT23	27V zener 0.225W
<b>81E</b>	PMBZ5254B	Mot	C	SOT23	27V zener 0.225W
<b>81F</b>	MMBZ5255B	Mot	C	SOT23	28V zener 0.225W
<b>81F</b>	PMBZ5255B	Sie	C	SOT23	28V zener 0.225W
<b>81G</b>	MMBZ5256B	Mot	C	SOT23	30V zener 0.225W
<b>81G</b>	PMBZ5256B	Phi	C	SOT23	30V zener 0.225W
<b>81H</b>	MMBZ5257B	Mot	C	SOT23	33V zener 0.225W
<b>81H</b>	PMBZ5257B	Phi	C	SOT23	33V zener 0.225W
<b>82</b>	2SC5009	Nec	N	-	npn RF ft 12GHz @ 3V 5mA
<b>82</b>	ZMV832BV2	Zet	I	SOD523	28V hyperabrupt varicap 22pF @2V
<b>82P</b>	BFP182T	Tfk	X	-	npn RF ft 7.5GHz 10V 35mA
<b>83</b>	MMBT4400	Nat	N	-	npn 2N4400
<b>83s</b>	BAT68	Sie	C	SOT23	gp Schottky 8V 130mA
<b>83s</b>	BAT68W	Sie	C	SOT323	gp Schottky 8V 130mA
<b>83</b>	2SC5010	Nec	N	-	npn RF ft 12GHz 3V 10mA
<b>83</b>	MA4CS102A	M/A	C	SOT23	schottky diode 8V 30mA
<b>83P</b>	BFP183T	Tfk	X	-	npn RF ft 7.4GHz 10V 65mA
<b>84s</b>	BAT68-04	Sie	D	SOT23	dual ser gp Schottky 8V 130mA
<b>84s</b>	BAT68-04W	Sie	D	SOT323	dual ser gp Schottky 8V 130mA
<b>84</b>	MA4CS102B	M/A	D	SOT23	dual ser schottky diode 8V 30mA
<b>84</b>	DTC114WE	Rho	N	EMT3	npn dtr 10k + 4k7 50V 100mA
<b>84</b>	DTC114WUA	Rho	N	SC70	npn dtr 10k + 4k7 50V 100mA
<b>84</b>	DTC114WKA	Rho	N	SC59	npn dtr 10k + 4k7 50V 100mA
<b>85</b>	MMBD1701	Nat	C	-	Fast Si diode 30V 50mA
<b>85</b>	MA4CS102A	M/A	B	SOT23	dual cc schottky diode 8V 30mA
<b>85s</b>	BAT68-05	Sie	B	SOT23	gp dual cc Schottky 8V 130mA
<b>85s</b>	BAT68-05W	Sie	B	SOT323	gp dual cc Schottky 8V 130mA
<b>86</b>	MMBD1702	Nat	K	-	Fast Si diode 30V 50mA
<b>86</b>	DTC144WE	Rho	N	EMT3	npn dtr 47k + 22k 50V 30mA
<b>86</b>	DTC144WUA	Rho	N	SC70	npn dtr 47k + 22k 50V 30mA
<b>86</b>	DTC144WKA	Rho	N	SC59	npn dtr 47k + 22k 50V 30mA
<b>86s</b>	BAT68-06	Sie	A	SOT23	gp dual ca Schottky 8V 130mA
<b>86s</b>	BAT68-06W	Sie	A	SOT323	gp dual ca Schottky 8V 130mA
<b>87</b>	MMBD1703	Nat	D	-	dual ser MMBD1701
<b>87</b>	MA4CS102A	M/A	S	SOT143	dual schottky diode 8V 30mA
<b>87s</b>	BAT68-07	Sie	S	SOT143	gp dual schottky 8V 130mA
<b>88</b>	MMBD1704	Nat	B	-	dual cc MMBD1701
<b>89</b>	MMBD1705	Nat	A	-	dual ca MMBD1701
<b>821</b>	PZM8.2NB1	Phi	C	SOT23	8.2V 0.3W zener
<b>822</b>	PZM8.2NB2	Phi	C	SOT23	8.2V 0.3W zener
<b>822</b>	S822T	Tfk	X	-	npn RF ft 5.2GHz 6V 8mA
<b>823</b>	PZM8.2NB3	Phi	C	SOT23	8.2V 0.3W zener

852	S852T	Tfk	N	SOT23	npn RF FT 5.2GHz 6V 8mA
887	S887T	Tfk	W	SOT143	n-ch dg uhf mosfet
888	S888T	Tfk	W	SOT142	n-ch dg uhf mosfet
8A	NJM78L02A	NJR	KQ	SOT89	78L 2.0V 0.1A regulator
8A	MMBZ5226B	Mot	C	SOT23	3.3V zener 0.225W
8A	MUN2211	Mot	N	SOT23	npn dtr 10k +10k
8A	MUN5211	Mot	N	SOT323	npn dtr 10k +10k
8A2	PZM8.2NB2A	Phi	C	SOT23	dual ca 8.2V 0.3W zener
8B	NJM78L03A	NJR	KQ	SOT89	78L 3.0V 0.1A regulator
8B	MMBZ5227B	Mot	C	SOT23	3.6V zener 0.225W
8B	MUN2212	Mot	N	SOT23	npn dtr 22k+22k
8B	MUN5212	Mot	N	SOT323	npn dtr 22k+22k
8C	NJM78L05A	NJR	KQ	SOT89	78L 5.0V 0.1A regulator
8C	MMBZ5228B	Mot	C	SOT23	3.9V zener 0.225W
8C	MUN2213	Mot	N	SOT23	npn dtr 47k + 47k
8C	MUN5213	Mot	N	SOT323	npn dtr 47k + 47k
8D	MUN2214	Mot	N	SOT23	npn dtr 10k + 47k
8D	MUN5214	Mot	N	SOT323	MUN2214
8E	NJM78L06A	NJR	KQ	SOT89	78L 6.0V 0.1A regulator
8E	FMMT-A92R	Zet	R	SOT23R	MPSA92
8E	MMBZ5230B	Mot	C	SOT23	4.7V zener 0.225W
8E	MUN2215	Mot	N	SOT23	npn dtr R1 10k
8E	MUN5215	Mot	N	SOT323	npn dtr R1 10k
8F	NJM78L07A	NJR	KQ	SOT89	78L 7.0V 0.1A regulator
8F	MMBZ5231B	Mot	C	SOT23	5.1V zener 0.225W
8F	MUN2216	Mot	N	SOT23	npn dtr R1 4k7
8F	MUN5216	Mot	N	SOT323	MUN2216
8G	NJM78L08A	NJR	KQ	SOT89	78L 8.0V 0.1A regulator
8G	MMBZ5232B	Mot	C	SOT23	5.6V zener 0.225W
8G	MUN2230	Mot	N	SOT23	npn dtr 1k0+1k0
8G	MUN5230	Mot	N	SOT323	npn dtr 1k0+1k0
8H	NJM78L09A	NJR	KQ	SOT89	78L 9.0V 0.1A regulator
8H	MMBZ5233B	Mot	C	SOT23	6.0V zener 0.225W
8H	MUN2231	Mot	N	SOT23	npn dtr 2k2+2k2
8H	MUN5231	Mot	N	SOT323	npn dtr 2k2+2k2
8J	NJM78L10A	NJR	KQ	SOT89	78L 10V 0.1A regulator
8J	MMBZ5234B	Mot	C	SOT23	6.2V zener 0.225W
8J	MUN2232	Mot	N	SOT23	npn dtr 4k7+ 4k7
8J	MUN5232	Mot	N	SOT323	npn dtr 4k7+ 4k7
8K	NJM78L12A	NJR	KQ	SOT89	78L 12V 0.1A regulator
8K	MMBZ5235B	Mot	C	SOT23	6.8V zener 0.225W
8K	MUN2233	Mot	N	SOT23	npn dtr 4k7+ 47k
8K	MUN5233	Mot	N	SOT323	npn dtr 4k7+ 47k
8L	NJM78L15A	NJR	KQ	SOT89	78L 15V 0.1A regulator
8L	MMBZ5236B	Mot	C	SOT23	7.5V zener 0.225W
8L	MUN2234	Mot	N	SOT23	npn dtr 22k + 47k
8L	MUN5234	Mot	N	SOT323	npn dtr 22k + 47k
8M	NJM78L18A	NJR	KQ	SOT89	78L 18V 0.1A regulator
8M	MMBZ5237B	Mot	C	SOT23	8.2V zener 0.225W
8N	NJM78L20A	NJR	KQ	SOT89	78L 20V 0.1A regulator
8N	MMBZ5238B	Mot	C	SOT23	8.7V zener 0.225W
8P	NJM78L24A	NJR	KQ	SOT89	78L 24V 0.1A regulator
8P	MMBZ5239B	Mot	C	SOT23	9.1V zener 0.225W
8Q	MMBZ5240B	Mot	C	SOT23	10V zener 0.225W
8R	MMBZ5241B	Mot	C	SOT23	11V zener 0.225W
8S	MMBZ5242B	Mot	C	SOT23	12V zener 0.225W
8T	MMBZ5243B	Mot	C	SOT23	13V zener 0.225W
8U	MMBZ5244B	Mot	C	SOT23	14V zener 0.225W
8V	MMBZ5245B	Mot	C	SOT23	15V zener 0.225W
8V2	PZM8.2NB	Phi	C	SOT23	8.2V 0.3W zener
8W	MMBZ5246B	Mot	C	SOT23	16V zener 0.225W
8X	MMBZ5247B	Mot	C	SOT23	17V zener 0.225W
8Y	MMBZ5248B	Mot	C	SOT23	18V zener 0.225W
8Y2	BZV49-C8V2	Phi	O	SOT89	8.2V 1W zener
8Z	NJM78L62A	NJR	KQ	SOT89	78L 6.2V 0.1A regulator

<b>8Z</b>	MMBZ5249B	Mot	C	SOT23	19V zener 0.225W
-----------	-----------	-----	---	-------	------------------

### Codes beginning with '9'

Code	Device	Manufacturer	Base	Package	Leaded Equivalent/Data
<b>9</b>	BC849	Mot	N	SOT23	BC 549B
<b>91</b>	ZV931V2	Zet	I	SOD523	4-13.5pF hyperabrupt varicap
<b>91</b>	DTA113TKA	Roh	N	SC59	pnnp dtr R11k0 50V 100mA
<b>91A</b>	FMMT591A	Zet	N	SOT23	pnnp 40V 1A 0.5W fT 150 MHz
<b>92</b>	ZV932V2	Zet	I	SOD523	5.5-17pF hyperabrupt varicap
<b>92V</b>	BFP92A	Tfk	W	-	npn RF 6GHz 16V 30mA
<b>93</b>	ZV933V2	Zet	I	SOD523	12-42pF hyperabrupt varicap
<b>93</b>	DTA143TE	Roh	N	EMT3	pnnp dtr R1 4k7 50V 100mA
<b>93</b>	DTA143TUA	Roh	N	SC70	pnnp dtr R1 4k7 50V 100mA
<b>93</b>	DTA143TKA	Roh	N	SC59	pnnp dtr R1 4k7 50V 100mA
<b>94</b>	DTA114TE	Roh	N	EMT3	pnnp dtr R1 10k 50V 100mA
<b>94</b>	DTA114TUA	Roh	N	SC70	pnnp dtr R1 10k 50V 100mA
<b>94</b>	DTA114TKA	Roh	N	SC59	pnnp dtr R1 10k 50V 100mA
<b>95</b>	DTA124TE	Roh	N	EMT3	pnnp dtr R1 22k 50V 100mA
<b>95</b>	DTA124TCA	Roh	N	SOT23	pnnp dtr R1 22k 50V 100mA
<b>95</b>	DTA124TKA	Roh	N	SC59	pnnp dtr R1 22k 50V 100mA
<b>96</b>	DTA144TE	Roh	N	EMT3	pnnp dtr R1 47k 50V 100mA
<b>96</b>	DTA144TUA	Roh	N	SC70	pnnp dtr R1 47k 50V 100mA
<b>96</b>	DTA144TKA	Roh	N	SC59	pnnp dtr R1 47k 50V 100mA
<b>99</b>	DTA115TE	Roh	N	EMT3	pnnp dtr R1 100k 50V 100mA
<b>99</b>	DTA115TUA	Roh	N	SC70	pnnp dtr R1 100k 50V 100mA
<b>99</b>	DTA115TKA	Roh	N	SC59	pnnp dtr R1 100k 50V 100mA
<b>911</b>	PZM9.1NB1	Phi	C	SOT346	9.1V 0.3W zener
<b>912</b>	PZM9.1NB2	Phi	C	SOT346	9.1V 0.3W zener
<b>913</b>	PZM9.1NB3	Phi	C	SOT346	9.1V 0.3W zener
<b>9A</b>	FMMT2369AR	Zet	R	SOT23	2N2369A
<b>9A</b>	DTA125TUA	Roh	N	SC70	pnnp dtr R1 200k 50V 100mA
<b>9A</b>	DTA125TKA	Roh	N	SC59	pnnp dtr R1 200k 50V 100mA
<b>9A</b>	PLVA650A	Phi	C	SOT23	5.0V avalanche reg diode
<b>9A1</b>	PZM9.1NB2A	Phi	A	SOT346	dual ca 9.1V 0.3W zener
<b>9B</b>	NJM79L03UA	NJR	KQR	SOT89	79L reg 3.0V 0.1A
<b>9B</b>	PLVA653A	Phi	C	SOT23	5.3V avalanche reg diode
<b>9C</b>	NJM79L05UA	NJR	KQR	SOT89	79L reg 5.0V 0.1A
<b>9C</b>	PLVA656A	Phi	C	SOT23	5.6V avalanche reg diode
<b>9D</b>	PLVA659A	Phi	C	SOT23	5.9V avalanche reg diode
<b>9E</b>	NJM79L06UA	NJR	KQR	SOT89	79L reg 6.0V 0.1A
<b>9E</b>	PLVA662A	Phi	C	SOT23	6.2V avalanche reg diode
<b>9F</b>	PLVA665A	Phi	C	SOT23	6.5V avalanche reg diode
<b>9G</b>	NJM79L08UA	NJR	KQR	SOT89	79L reg 8.0V 0.1A
<b>9G</b>	PLVA668A	Phi	C	SOT23	6.8V avalanche reg diode
<b>9H</b>	NJM79L09UA	NJR	KQR	SOT89	79L reg 9.0V 0.1A
<b>9J</b>	PLVA2650A	Phi	A	SOT23	dual ca 5.0V reg diode
<b>9K</b>	NJM79L12UA	NJR	KQR	SOT89	79L reg 12V 0.1A
<b>9K</b>	PLVA2653A	Phi	A	SOT23	dual ca 5.3V reg diode
<b>9L</b>	NJM79L15UA	NJR	KQR	SOT89	79L reg 15V 0.1A
<b>9L</b>	PLVA2656A	Phi	A	SOT23	>dual 5.60V reg diode
<b>9M</b>	NJM79L18UA	NJR	KQR	SOT89	79L reg 18V 0.1A
<b>9M</b>	PLVA2659A	Phi	A	SOT23	dual ca 5.9V reg diode
<b>9N</b>	PLVA2662A	Phi	A	SOT23	dual ca 6.2V reg diode
<b>9O</b>	PLVA2665A	Phi	A	SOT23	dual ca 6.5V reg diode
<b>9P</b>	NJM79L24UA	NJR	KQR	SOT89	79L reg 24V 0.1A
<b>9P</b>	PLVA2668A	Phi	A	SOT23	dual ca 6.8V reg diode
<b>9P</b>	BCX70HR	Zet	R	SOT23	BCX70H
<b>9R</b>	FMMT2369R	Zet	R	SOT23	2N2369
<b>9V1</b>	PZM9.1NB	Phi	C	SOT346	9.1V 0.3W zener
<b>9Y1</b>	BZV49-C9V1	Phi	O	SOT89	9.1V 1W zener

### Codes beginning with 'A'

Code	Device	Manufacturer	Base	Package	Leaded Equivalent/Data
A	BA892	Sie	I	SCD80	35V 100mA pin
A	1SS355	Roh	I	USM	100V 50mA sw
A	MRF947	Mot	N	SOT323	npn RF 8 GHz
A0	HSMS-2800	HP	C	SOT23	HP2800 schottky
A0	HSMS-280B	HP	C	SOT323	HP2800 schottky
A03	VAM-03	MC	AQ	-	modamp MAR 3 Similar
A06	VAM-06	MC	AQ	-	modamp MAR 6 Similar
A07	VAM-07	MC	AQ	-	modamp MAR 7 Similar
A1	HSMS-2801	HP	K	-	HP2800 schottky
A1	BAW56W	Phi	A	SOT323	dual ca BAW62 (1N4148)
A1	BAW56	Phi	A	SOT23	dual ca BAW62 (1N4148)
A1	BAW56	Phi	A	SOT23	dual ca BAW62 (1N4148)
A1p	BAW56	Phi	A	SOT23	dual ca BAW62 (1N4148)
A1t	BAW56T	Phi	A	SOT416	dual ca BAW62 (1N4148)
A1t	BAW56S	Phi		SOT363	dual ca BAW62 (1N4148)
A1s	BAW56W	Sie	A	SOT323	dual ca BAW62 (1N4148)
A1s	BAW56	Sie	A	SOT23	dual ca BAW62 (1N4148)
A1s	BAW56U	Sie	A	SC74	dual ca BAW62 (1N4148)
A1X	MBAW56	Mot	A	-	ditto
A2	HSMS-2802	HP	D	SOT23	dual HP2800
A2	HSMS-280C	HP	D	SOT323	dual HP2800
A2	BAT18	Phi	C	SOT23	BA482
A2s	BAT18	Sie	C	SOT23	BA482
A2	MMBD2836	Mot	A	SOT23	dual ca sw diode 75V
A2	CFY30	Sie	CQ	SOT143	n-ch GaAsfet 6 GHz
A2	MBT3906DW1	Mot	DO	SOT363	dual 2N3906
A22	BAS21	Phi	C	SOD27	BAV21
A2X	MMBD2836	Mot	A	SOT23	dual ca sw 75V 100mA 15ns
A3	BAP64-03	Phi	I	SOD323	3 GHz pin diode
A3	HSMS-2803	HP	D	SOT23	HP2800 ser pair
A3	MMBD1005	Mot	A	SOT23	dual ca Si diode low leakage
A3	BAS16	Zet	C	-	Si sw 75V 100mA
A3	BAT17	Phi	C	SOT23	BA481
A3p	BAT17	Phi	C	SOT23	BA481
A3t	BAT17	Phi	C	SOT23	BA481
A3	MBT3906DW	Mot	N	SOT363	dual 2N3906
A3X	MMBD2835	Mot	A	SOT23	dual ca sw 35V 100mA 15nS
A4	HSMS-2804	HP	B	SOT23	dual cc HP2800 schottky
A4s	BAV70W	Sie	B	SOT323	dual cc BAW62
A4s	BAV70	Sie	B	SOT23	dual cc BAW62
A4s	BAV70T	Sie	B	SOT416	dual cc BAW62
A4s	BAV70U	Sie	B	SC74	dual cc BAW62
A4	BAV70W	Phi	B	SOT323	dual cc BAW62
A4p	BAV70	Phi	B	SOT23	dual cc BAW62
A4t	BAV70	Phi	B	SOT23	dual cc BAW62
A4t	BAV70	Phi	B	SOT363	dual cc BAW62
A4X	MBAV70	Mot	B	-	ditto
A5	BAP51-03	Phi	I	SOD323	GP RF pin diode
A5p	BRY61	Phi	-	SOT143	-
A5t	BRY61	Phi	-	SOT143	-
A5	HSMS-2805	HP	S	SOT143	dual HP2800 schottky
A5	MMBD1010	Mot	B	SOT23	dual cc Si diodes
A5	MMBD2837	Mot	B	SOT23	dual cc diodes 30V 150mA
A6s	BAS16W	Sie	C	SOT323	BAW62 (1N4148)
A6s	BAS16	Sie	C	SOT23	BAW62 (1N4148)
A6s	BAS16U	Sie	C	SC74	BAW62 (1N4148)
A6	BAS16W	Phi	C	SOT323	BAW62 (1N4148)
A6p	BAS16	Phi	C	SOT23	BAW62 (1N4148)
A6t	BAS16	Phi	C	SOT23	BAW62 (1N4148)
A6	BAS16T	Phi	C	SOT416	BAW62 (1N4148)
A6	BAS216	Phi	I	SOD110	BAW62 (1N4148)
A6p	BAS316	Phi	I	SOD323	BAW62 (1N4148)
A6	MMBD2836	Mot	B	SOT23	dual sw diode cc 75V
A6A	MMUN2111	Mot	N	SOT23	pnp dtr 10k+10k

A6B	MMUN2112	Mot	N	SOT23	pnp dtr 22k+22k
A6C	MMUN2113	Mot	N	SOT23	pnp dtr 47k+47k
A6D	MMUN2114	Mot	N	SOT23	pnp dtr 100k+100k
A6E	MMUN2115	Mot	N	SOT23	pnp dtr R1 10k
A6F	MMUN2116	Mot	N	SOT23	pnp dtr R1 4k7
A6G	MMUN2130	Mot	N	SOT23	pnp dtr 1k0+1k0
A6H	MMUN2131	Mot	N	SOT23	pnp dtr 2k2+2k2
A6J	MMUN2132	Mot	N	SOT23	pnp dtr 4k7+4k7
A6K	MMUN2133	Mot	N	SOT23	pnp dtr 4k7+47k
A6L	MMUN2134	Mot	N	SOT23	pnp dtr 22k+47k
A6X	MMBD2838	Mot	B	SOT23	dual sw 50V 100mA
A7s	BAV99	Sie	D	SOT23	dual ser BAW92
A7s	BAV99W	Sie	D	SOT323	dual ser BAW92
A7s	BAV99T	Sie	D	SC75	dual ser BAW92
A7s	BAV99U	Sie	D	SC74	dual ser BAW92
A7	BAV99W	Phi	D	SOT323	dual ser BAW92
A7	BAV99	Phi	D	SOT23	dual ser BAW92
A7	HSMS-2807	HP	RQ	SOT143	HP2800 ring quad
A8	HSMS-2808	HP	BQ	SOT143	HP2800 bridge quad
A8	BAP50-03	Phi	I	SOD323	GP RF pin diode
A8	BAS19	Phi	C	SOT23	BAV19
A8	SI2308DS	Sil	M	SOT23	N-ch mosfet, 60V 0.1A
A8A	MMUN2211	Mot	N	SOT23	npn dtr 10k +10k
A8B	MMUN2212	Mot	N	SOT23	npn dtr 22k +22k
A8C	MMUN2213	Mot	N	SOT23	npn dtr 47k+47k
A8D	MMUN2214	Mot	N	SOT23	npn dtr 100k+100k
A8E	MMUN2215	Mot	N	SOT23	npn dtr R1 10k
A8F	MMUN2216	Mot	N	SOT23	npn dtr R1 4k7
A8G	MMUN2230	Mot	N	SOT23	npn dtr 1k0 +1k0
A8H	MMUN2231	Mot	N	SOT23	npn dtr 2k2+2k2
A8J	MMUN2232	Mot	N	SOT23	npn dtr 4k7+4k7
A8K	MMUN2233	Mot	N	SOT23	npn dtr 4k7+47k
A8L	MMUN2234	Mot	N	SOT23	npn dtr 22k+47k
A9	SI2309DS	Sil	M	SOT23	P-ch mosfet, 60V 0.1A
A11	MMBD1501A	Fch	C	SOT23	180V 200mA diode
A13	MMBD1503A	Fch	D	SOT23	180V 200mA dual diode series
A14	MMBD1504A	Fch	B	SOT23	180V 200mA dual diode cc
A15	MMBD1505A	Fch	A	SOT23	180V 200mA dual diode ca
A16	ZC934A	Zet	C	SOT23	25-95pF hyperabrupt varicap
A17	ZC933A	Zet	C	SOT23	12-42pF hyperabrupt varicap
A51	BRY62	Phi	-	SOT143	-
A81	BAS20	Phi	C	SOT23	BAV20
A82	BAS21	Phi	C	SOT23	BAV21
A91	BAS17	Phi	C	SOT23	BA314
AA	BCX51	Sie	P	SOT89	pnnp 45V audio comp BCX54
AA	BCW60A	TT	N	SOT23	BCY58-vii
AA	ZMV829A	Zet	I	SOD323	varicap hyperabrupt 28V 8.2pF@2V
AAs	BCW60A	Sie	N	SOT23	BCY58-vii
AAA	MMBF4856	Mot	F	SOT23	2N4856 n-ch chopper jfet
AAAA	MAX809LXR	MAX	ZB	SOT23	microproc -ve reset gen 5.0V
AAAX	MAX2470	MAX	DT	SOT23-6	VCO Buffer Amplifiers
AAAY	MAX2471	MAX	DT	SOT23-6	VCO Buffer Amplifiers
AAG	MMBR951AL	Mot	N	SOT23	npn RF 8GHz
AAH	MAX6326_R22-T	Max	ZB	SC70	microproc -ve reset gen 2.200V
AAI	MAX6327_R22-T	Max	ZB	SC70	microproc +ve reset gen 2.200V
AAJ	MAX6328_R22-T	Max	ZB	SC70	microproc -ve reset gen 2.200V
AAK	MAX6410BS33-T	Max	UC4	UCSP-4	Volt. Detect. (3.300 V / Push-Pull,Active-High)
AAL	MAX6410BS34-T	Max	UC4	UCSP-4	Volt. Detect. (3.400 V / Push-Pull,Active-High)
AAM	MAX6410BS35-T	Max	UC4	UCSP-4	Volt. Detect. (3.500 V / Push-Pull,Active-High)
AAN	MAX6410BS36-T	Max	UC4	UCSP-4	Volt. Detect. (3.600 V / Push-Pull,Active-High)
AAN	MAX809LXR	Max	ZB	SC70	microproc -ve reset gen 5.0V
AAO	MAX6410BS37-T	Max	UC4	UCSP-4	Volt. Detect. (3.700 V / Push-Pull,Active-High)
AAO	MAX809MXR	Max	ZB	SC70	microproc -ve reset gen 5.0V
AAP	MAX6410BS38-T	Max	UC4	UCSP-4	Volt. Detect. (3.800 V / Push-Pull,Active-High)

<b>AAP</b>	MAX809TXR	Max	ZB	SC70	microproc -ve reset gen 3.3V
<b>AAQ</b>	MAX6410BS39-T	Max	UC4	UCSP-4	Volt. Detect. (3.900 V / Push-Pull,Active-High)
<b>AAQ</b>	MAX809SXR	Max	ZB	SC70	microproc -ve reset gen 3.3V
<b>AAR</b>	MAX6410BS40-T	Max	UC4	UCSP-4	Volt. Detect. (4.000 V / Push-Pull,Active-High)
<b>AAR</b>	MAX809RXR	Max	ZB	SC70	microproc -ve reset gen 3.0V
<b>AAS</b>	MAX6410BS41-T	Max	UC4	UCSP-4	Volt. Detect. (4.100 V / Push-Pull,Active-High)
<b>AAS</b>	MAX803ZXR	Max	ZB	SC70	microproc -ve reset gen 2.5V
<b>AAT</b>	MAX6410BS42-T	Max	UC4	UCSP-4	Volt. Detect. (4.200 V / Push-Pull,Active-High)
<b>AAT</b>	MAX810LXR	Max	ZB	SC70	microproc +ve reset gen 5.0V
<b>AAU</b>	MAX6410BS43-T	Max	UC4	UCSP-4	Volt. Detect. (4.300 V / Push-Pull,Active-High)
<b>AAU</b>	MAX810MXR	Max	ZB	SC70	microproc +ve reset gen 5.0V
<b>AAV</b>	MAX6410BS44-T	Max	UC4	UCSP-4	Volt. Detect. (4.380 V / Push-Pull,Active-High)
<b>AAV</b>	MAX810TXR	Max	ZB	SC70	microproc +ve reset gen 3.3V
<b>AAW</b>	MAX6410BS45-T	Max	UC4	UCSP-4	Volt. Detect. (4.500 V / Push-Pull,Active-High)
<b>AAW</b>	MAX810RXR	Max	ZB	SC70	microproc +ve reset gen 3.0V
<b>AAX</b>	MAX6410BS46-T	Max	UC4	UCSP-4	Volt. Detect. (4.630 V / Push-Pull,Active-High)
<b>AAX</b>	MAX810SXR	Max	ZB	SC70	microproc +ve reset gen 3.3V
<b>AAZ</b>	MAX6411BS33-T	Max	UC4	UCSP-4	Volt. Detect. (3.300 V/Open Drain,Active-Low)
<b>AAZ</b>	MAX810ZXR	Max	ZB	SC70	microproc +ve reset gen 2.5V
<b>AAZ</b>	MAX6411BS34-T	Max	UC4	UCSP-4	Volt. Detect. (3.400 V/Open Drain,Active-Low)
<b>AAZ</b>	MAX803LXR	Max	ZB	SC70	microproc -ve reset gen 5.0V
<b>AB</b>	BCW60B	ITT	N	SOT23	BCY58-viii
<b>AB</b>	ZMV830A	Zet	I	SOD323	varicap hyperabrupt 28V 10pF@2V
<b>ABs</b>	BCW60B	Sie	N	SOT23	BCY58-viii
<b>ABp</b>	BCW60B	Phi	N	SOT23	BCY58-viii
<b>ABt</b>	BCW60B	Phi	N	SOT23	BCY58-viii
<b>ABA</b>	MAX6411BS35-T	Max	UC4	UCSP-4	Volt. Detect. (3.500 V/Open Drain,Active-Low)
<b>ABA</b>	MAX803TXR	Max	ZB	SC70	microproc -ve reset gen 5.0V
<b>ABAA</b>	MAX809MXR	Max	ZB	SOT23	microproc -ve reset gen 5.0V
<b>ABB</b>	MAX6411BS36-T	Max	UC4	UCSP-4	Volt. Detect. (3.600 V/Open Drain,Active-Low)
<b>ABB</b>	MAX803MXR	Max	ZB	SC70	microproc -ve reset gen 3.3V
<b>ABC</b>	MAX6411BS37-T	Max	UC4	UCSP-4	Volt. Detect. (3.700 V/Open Drain,Active-Low)
<b>ABC</b>	MAX803SXR	Max	ZB	SC70	microproc -ve reset gen 3.3V
<b>ABD</b>	MAX6411BS38-T	Max	UC4	UCSP-4	Volt. Detect. (3.800 V/Open Drain,Active-Low)
<b>ABD</b>	MAX803RXR	Max	ZB	SC70	microproc -ve reset gen 3.0V
<b>ABE</b>	MAX6411BS39-T	Max	UC4	UCSP-4	Volt. Detect. (3.900 V/Open Drain,Active-Low)
<b>ABE</b>	MAX803ZXR	Max	ZB	SC70	microproc -ve reset gen 2.5V
<b>ABF</b>	MAX6411BS40-T	Max	UC4	UCSP-4	Volt. Detect. (4.000 V/Open Drain,Active-Low)
<b>ABF</b>	LM4041AIX3-1.2	Max	L	SC70	1.225V 0.1% shunt V ref
<b>ABG</b>	MAX6411BS41-T	Max	UC4	UCSP-4	Volt. Detect. (4.100 V/Open Drain,Active-Low)
<b>ABG</b>	LM4041BIX3-1.2	Max	L	SC70	1.225V 0.2% shunt V ref
<b>ABH</b>	MAX6411BS42-T	Max	UC4	UCSP-4	Volt. Detect. (4.200 V/Open Drain,Active-Low)
<b>ABH</b>	LM4041DIX3-1.2	Max	L	SC70	1.225V 0.5% shunt V ref
<b>ABI</b>	MAX6411BS43-T	Max	UC4	UCSP-4	Volt. Detect. (4.300 V/Open Drain,Active-Low)
<b>ABI</b>	LM4041DIX3-1.2	Max	L	SC70	1.225V 1.5% shunt V ref
<b>ABJ</b>	MAX6411BS44-T	Max	UC4	UCSP-4	Volt. Detect. (4.380 V/Open Drain,Active-Low)
<b>ABJ</b>	LM4040AIX3-2.1	Max	L	SC70	2.048V 0.1% shunt V ref
<b>ABK</b>	MAX6411BS45-T	Max	UC4	UCSP-4	Volt. Detect. (4.500 V/Open Drain,Active-Low)
<b>ABK</b>	LM4040BIX3-2.1	Max	L	SC70	2.048V 0.2% shunt V ref
<b>ABL</b>	MAX6411BS46-T	Max	UC4	UCSP-4	Volt. Detect. (4.640 V/Open Drain,Active-Low)
<b>ABL</b>	LM4040CIX3-2.1	Max	L	SC70	2.048V 0.5% shunt V ref
<b>ABM</b>	LM4040DIX3-2.1	Max	L	SC70	2.048V 1% shunt V ref
<b>ABN</b>	LM4040AIX3-2.5	Max	L	SC70	2.5001% shunt V ref
<b>ABO</b>	LM4040BIX3-2.5	Max	L	SC70	2.500V 0.2% shunt V ref
<b>ABP</b>	LM4040CIX3-2.5	Max	L	SC70	2.500V 0.5% shunt V ref
<b>ABQ</b>	LM4040DIX3-2.5	Max	L	SC70	2.500V 1% shunt V ref
<b>ABR</b>	LM4040AIX3-3.0	Max	L	SC70	3.000V 0.1% shunt V ref
<b>ABS</b>	LM4040BIX3-3.0	Max	L	SC70	3.000V 0.2% shunt V ref
<b>ABT</b>	LM4040CIX3-3.0	Max	L	SC70	3.000V 0.5% shunt V ref
<b>ABU</b>	LM4040DIX3-3.0	Max	L	SC70	3.000V 1% shunt V ref
<b>ABV</b>	LM4040AIX3-4.1	Max	L	SC70	4.096V 0.1% shunt V ref
<b>ABW</b>	LM4040BIX3-4.1	Max	L	SC70	4.096V 0.2% shunt V ref
<b>ABX</b>	LM4040CIX3-4.1	Max	L	SC70	4.096V 0.5% shunt V ref
<b>ABY</b>	LM4040DIX3-4.1	Max	L	SC70	4.096V 1% shunt V ref
<b>ABZ</b>	LM4040AIX3-5.0	Max	L	SC70	5.000V 0.1% shunt V ref

AC	BCX51-100	Sie	P	SOT89	45V pnp audio hfe 100
AC	BCX51-10	Phi	P	SOT89	45V pnp audio hfe 100
AC	BCW60C	Phi	N	SOT23	BCY58-ix
AC	ZMV831A	Zet	I	SOD323	varicap hyperabrupt 28V 15pF@2V
ACs	BCW60C	Sie	N	SOT23	BCY58-ix
ACp	BCW60C	Phi	N	SOT23	BCY58-ix
ACt	BCW60C	Phi	N	SOT23	BCY58-ix
ACA	LM4040BIX3-5.0	Max	L	SC70	5.000V 0.2% shunt V ref
ACAA	MAX809TXR	Max	ZB	SOT23	microproc -ve reset gen 3.3V
ACB	LM4040CIX3-5.0	Max	L	SC70	5.000V 0.5% shunt V ref
ACC	LM4040DIX3-5.0	Max	L	SC70	5.000V 1% shunt V ref
ACE	MAX6326_R31-T	Max	ZB	SC70	microproc -ve reset gen 3.080V
ACF	MAX6347_R46-T	Max	ZB	SC70	microproc +ve reset gen 4.630V
ACH	MAX6326_R23-T	Max	ZB	SC70	microproc -ve reset gen 2.320V
ACI	MAX6326_R26-T	Max	ZB	SC70	microproc -ve reset gen 2.630V
ACJ	MAX6328_R26-T	Max	ZB	SC70	microproc -ve reset gen 2.630V
ACK	MAX6346_R44-T	Max	ZB	SC70	microproc -ve reset gen 4.380V
ACL	MAX6347_R44-T	Max	ZB	SC70	microproc +ve reset gen 4.380V
ACM	MAX6348_R46-T	Max	ZB	SC70	microproc -ve reset gen 4.630V
ACN	MAX6348_R44-T	Max	ZB	SC70	microproc -ve reset gen 4.380V
ACO	MAX6346_R46-T	Max	ZB	SC70	microproc -ve reset gen 4.630V
ACP	MAX6326_R29-T	Max	ZB	SC70	microproc -ve reset gen 2.930V
ACQ	MAX6327_R23-T	Max	ZB	SC70	microproc +ve reset gen 2.320V
ACR	MAX6327_R26-T	Max	ZB	SC70	microproc +ve reset gen 2.630V
ACS	MAX6327_R29-T	Max	ZB	SC70	microproc +ve reset gen 2.930V
ACT	MAX6327_R31-T	Max	ZB	SC70	microproc +ve reset gen 3.080V
ACU	MAX6328_R23-T	Max	ZB	SC70	microproc -ve reset gen 2.320V
ACV	MAX6328_R29-T	Max	ZB	SC70	microproc -ve reset gen 2.930V
ACW	MAX6326_R31-T	Max	ZB	SC70	microproc -ve reset gen 3.080V
AD	BCX51-160	Sie	P	SOT89	45V pnp audio hfe 160
AD	BCX51-16	Phi	P	SOT89	45V pnp audio hfe 160
AD	BCW60D	Phi	N	SOT23	BCY58-x
AD	ZMV832A	Zet	I	SOD323	varicap hyperabrupt 28V 22pF@2V
ADs	BCW60D	Sie	N	SOT23	BCY58-x
ADp	BCW60D	Phi	N	SOT23	BCY58-x
ADt	BCW60D	Ph	N	SOT23	BCY58-x
ADAA	MAX809SXR	Max	ZB	SOT23	microproc -ve reset gen 3.3V
ADN	2SC3838K	Roh	N	-	nnp 11V 3.2GHz TV tuners
ADW	MAX6406BS22-T	Max	UC4	UCSP-4	Volt. Detect. (2.200 V / Push-Pull, Active-Low)
ADX	MAX6406BS23-T	Max	UC4	UCSP-4	Volt. Detect. (2.320 V / Push-Pull, Active-Low)
ADY	MAX6406BS24-T	Max	UC4	UCSP-4	Volt. Detect. (2.400 V / Push-Pull, Active-Low)
ADZ	MAX6406BS25-T	Max	UC4	UCSP-4	Volt. Detect. (2.500 V / Push-Pull, Active-Low)
AE	BCX52	Sie	P	SOT89	pnp 60V audio comp BCX55
AE	ZMV833A	Zet	I	SOD323	varicap hyperabrupt 28V 33pF@2V
AEA	MAX6406BS26-T	MAX	UC4	UCSP-4	Volt. Detect. (2.630 V / Push-Pull, Active-Low)
AEB	MAX6406BS27-T	MAX	UC4	UCSP-4	Volt. Detect. (2.700 V / Push-Pull, Active-Low)
AEC	MAX6406BS28-T	MAX	UC4	UCSP-4	Volt. Detect. (2.800 V / Push-Pull, Active-Low)
AED	MAX6406BS29-T	MAX	UC4	UCSP-4	Volt. Detect. (2.930 V / Push-Pull, Active-Low)
AEE	MAX6406BS30-T	MAX	UC4	UCSP-4	Volt. Detect. (3.000 V / Push-Pull, Active-Low)
AEF	MAX6406BS31-T	MAX	UC4	UCSP-4	Volt. Detect. (3.080 V / Push-Pull, Active-Low)
AEG	MAX6407BS22-T	MAX	UC4	UCSP-4	Volt. Detect. (2.200 V / Push-Pull, Active-High)
AEH	MAX6407BS23-T	MAX	UC4	UCSP-4	Volt. Detect. (2.300 V / Push-Pull, Active-High)
AEI	MAX6407BS24-T	MAX	UC4	UCSP-4	Volt. Detect. (2.400 V / Push-Pull, Active-High)
AEJ	MAX6407BS25-T	MAX	UC4	UCSP-4	Volt. Detect. (2.500 V / Push-Pull, Active-High)
AEK	MAX6407BS26-T	MAX	UC4	UCSP-4	Volt. Detect. (2.630 V / Push-Pull, Active-High)
AEL	MAX6407BS27-T	MAX	UC4	UCSP-4	Volt. Detect. (2.700 V / Push-Pull, Active-High)
AEM	MAX6407BS28-T	MAX	UC4	UCSP-4	Volt. Detect. (2.800 V / Push-Pull, Active-High)
AEN	MAX6407BS29-T	MAX	UC4	UCSP-4	Volt. Detect. (2.930 V / Push-Pull, Active-High)
AEN	2SC3839K	Roh	N	-	nnp 20V 2.0GHz TV tuners
AEO	MAX6407BS30-T	Max	UC4	UCSP-4	Volt. Detect. (3.000 V / Push-Pull,Active-High)
AEP	MAX6407BS31-T	Max	UC4	UCSP-4	Volt. Detect. (3.000 V / Push-Pull,Active-High)
AEQ	MAX6408BS22-T	Max	UC4	UCSP-4	Volt. Detect. (2.200 V/Open Drain,Active-Low)
AER	MAX6408BS23-T	Max	UC4	UCSP-4	Volt. Detect. (2.320 V/Open Drain,Active-Low)
AES	MAX6408BS24-T	Max	UC4	UCSP-4	Volt. Detect. (2.400 V/Open Drain,Active-Low)
AET	MAX6408BS25-T	Max	UC4	UCSP-4	Volt. Detect. (2.500 V/Open Drain,Active-Low)



<b>AEU</b>	MAX6408BS26-T	Max	UC4	UCSP-4	Volt. Detect. (2.630 V/Open Drain,Active-Low)
<b>AEV</b>	MAX6408BS27-T	Max	UC4	UCSP-4	Volt. Detect. (2.700 V/Open Drain,Active-Low)
<b>AEW</b>	MAX6138AEXR12-T	Max	L	SC70-3	Shunt Voltage Ref. (output 1.2205 V / 0.1%)
<b>AEW</b>	MAX6408BS28-T	Max	UC4	SC70-3	Volt. Detect. (2.800 V/Open Drain,Active-Low)
<b>AEX</b>	MAX6138BEXR12-T	Max	L	SC70-3	Shunt Voltage Ref. (output 1.2205 V / 0.2%)
<b>AEX</b>	MAX6408BS29-T	Max	UC4	UCSP-4	Volt. Detect. (2.930 V/Open Drain,Active-Low)
<b>AEY</b>	MAX6138CEXR12-T	Max	L	SC70-3	Shunt Voltage Ref. (output 1.2205 V / 0.5%)
<b>AEY</b>	MAX6408BS30-T	Max	UC4	UCSP-4	Volt. Detect. (3.000 V/Open Drain,Active-Low)
<b>AEZ</b>	MAX6408BS31-T	Max	UC4	UCSP-4	Volt. Detect. (3.080 V/Open Drain,Active-Low)
<b>AF</b>	ZMV834A	Zet	I	SOD323	varicap hyperabrupt 28V 47pF@2V
<b>AFs</b>	BCW60FF	Sie	N	SOT23	BCY58
<b>AFA</b>	MAX6138AEXR21-T	Max	L	SC70-3	Shunt Voltage Ref. (output 2.0480 V / 0.1%)
<b>AFA</b>	MAX6409BS33-T	Max	-	UCSP-4	Volt. Detect. (3.300 V / Push-Pull, Active-Low)
<b>AFAA</b>	MAX809RXR	Max	ZB	SOT23	microproc -ve reset gen 3.0V
<b>AFB</b>	MAX6138BEXR21-T	Max	L	SC70-3	Shunt Voltage Ref. (output 2.0480 V / 0.2%)
<b>AFB</b>	MAX6409BS34-T	Max	UC4	UCSP-4	Volt. Detect. (3.400 V / Push-Pull, Active-Low)
<b>AFC</b>	MAX6138CEXR21-T	Max	L	SC70-3	Shunt Voltage Ref. (output 2.0480 V / 0.5%)
<b>AFC</b>	MAX6409BS35-T	Max	UC4	UCSP-4	Volt. Detect. (3.500 V / Push-Pull, Active-Low)
<b>AFD</b>	MAX6409BS36-T	Max	UC4	UCSP-4	Volt. Detect. (3.600 V / Push-Pull, Active-Low)
<b>AFE</b>	MAX6138AEXR25-T	Max	L	SC70-3	Shunt Voltage Ref. (output 2.5000 V / 0.1%)
<b>AFE</b>	MAX6409BS37-T	Max	UC4	UCSP-4	Volt. Detect. (3.700 V / Push-Pull, Active-Low)
<b>AFF</b>	MAX6138BEXR25-T	Max	L	SC70-3	Shunt Voltage Ref. (output 2.5000 V / 0.2%)
<b>AFF</b>	MAX6409BS38-T	Max	UC4	UCSP-4	Volt. Detect. (3.800 V / Push-Pull, Active-Low)
<b>AFG</b>	MAX6138CEXR25-T	Max	L	SC70-3	Shunt Voltage Ref. (output 2.5000 V / 0.5%)
<b>AFG</b>	MAX6409BS39-T	Max	UC4	UCSP-4	Volt. Detect. (3.900 V / Push-Pull, Active-Low)
<b>AFH</b>	MAX6409BS40-T	Max	UC4	UCSP-4	Volt. Detect. (4.000 V / Push-Pull, Active-Low)
<b>AFI</b>	MAX6138AEXR30-T	Max	L	SC70-3	Shunt Voltage Ref. (output 3.0000 V / 0.1%)
<b>AFI</b>	MAX6409BS41-T	Max	UC4	UCSP-4	Volt. Detect. (4.100 V / Push-Pull, Active-Low)
<b>AFJ</b>	MAX6138BEXR30-T	Max	L	SC70-3	Shunt Voltage Ref. (output 3.0000 V / 0.2%)
<b>AFJ</b>	MAX6409BS42-T	Max	UC4	UCSP-4	Volt. Detect. (4.200 V / Push-Pull, Active-Low)
<b>AFK</b>	MAX6138CEXR30-T	Max	L	SC70-3	Shunt Voltage Ref. (output 3.0000 V / 0.5%)
<b>AFK</b>	MAX6409BS43-T	Max	UC4	UCSP-4	Volt. Detect. (4.300 V / Push-Pull, Active-Low)
<b>AFL</b>	MAX6409BS44-T	Max	UC4	UCSP-4	Volt. Detect. (4.380 V / Push-Pull, Active-Low)
<b>AFM</b>	MAX6138AEXR41-T	Max	L	SC70-3	Shunt Voltage Ref. (output 4.0960 V / 0.1%)
<b>AFM</b>	MAX6409BS45-T	Max	UC4	UCSP-4	Volt. Detect. (4.500 V / Push-Pull, Active-Low)
<b>AFN</b>	MAX6138BEXR41-T	Max	L	SC70-3	Shunt Voltage Ref. (output 4.0960 V / 0.2%)
<b>AFN</b>	MAX6409BS46-T	Max	UC4	UCSP-4	Volt. Detect. (4.630 V / Push-Pull, Active-Low)
<b>AFO</b>	MAX6138CEXR41-T	Max	L	SC70-3	Shunt Voltage Ref. (output 4.0960 V / 0.5%)
<b>AFQ</b>	MAX6138AEXR50-T	Max	L	SC70-3	Shunt Voltage Ref. (output 5.0000 V / 0.1%)
<b>AFR</b>	MAX6138BEXR50-T	Max	L	SC70-3	Shunt Voltage Ref. (output 5.0000 V / 0.2%)
<b>AFS</b>	MAX6138CEXR50-T	Max	L	SC70-3	Shunt Voltage Ref. (output 5.0000 V / 0.5%)
<b>AG</b>	ZMV835A	Zet	I	SOD323	varicap hyperabrupt 28V 68pF@2V
<b>AG</b>	BCX70G	Phi	N	SOT23	BCY59-vii BC107
<b>AGs</b>	BCX70G	Sie	N	SOT23	BCY59-vii BC107
<b>AGp</b>	BCX70G	Phi	N	SOT23	BCY59-vii BC107
<b>AGt</b>	BCX70G	Phi	N	SOT23	BCY59-vii BC107
<b>AG</b>	BCX52-10	Sie	P	SOT89	60V pnp BCX52 hfe 100
<b>AGAA</b>	MAX810LXR	Max	ZB	SOT23	microproc +ve reset gen 5.0V
<b>AH</b>	BCX70H	Phi	N	SOT23	BCY59-viii BC107B
<b>AHs</b>	BCX70H	Sie	N	SOT23	BCY59-viii BC107B
<b>AHp</b>	BCX70H	Phi	N	SOT23	BCY59-viii BC107B
<b>AHt</b>	BCX70H	Phi	N	SOT23	BCY59-viii BC107B
<b>AH</b>	BCP53	Mot	P	SOT223	pnp amp 80V 150mA
<b>AH</b>	BCX53	Sie	P	SOT89	pnp 80V audio comp BCX56
<b>AH</b>	ZMV930	Zet	I	SOD323	2.9-8.3pF hyperabrupt varicap
<b>AHAA</b>	MAX810MXR	Max	ZB	SOT23	microproc +ve reset gen 5.0V
<b>AJ</b>	BCX70J	Phi	N	SOT23	BCY59-ix BC107
<b>AJs</b>	BCX70J	Sie	N	SOT23	BCY59-ix BC107
<b>AJp</b>	BCX70J	Phi	N	SOT23	BCY59-ix BC107
<b>AJt</b>	BCX70J	Phi	N	SOT23	BCY59-ix BC107
<b>AJ</b>	ZMV931	Zet	I	SOD323	4 -13.5pF hyperabrupt varicap
<b>AJAA</b>	MAX810TXR	MAX	ZB	SOT23	microproc +ve reset gen 3.3V
<b>AK</b>	BCX70K	Phi	N	SOT23	BCY59-x BC107
<b>AK</b>	ZMV932	Zet	I	SOD323	5.5-17pF hyperabrupt varicap
<b>AKs</b>	BCX70K	Sie	N	SOT23	BCY59-x BC107

AKp	BCX70K	Phi	N	SOT23	BCY59-x BC107
AKp	BCX70K	Phi	N	SOT23	BCY59-x BC107
AK	BCX53-10	Sie	P	SOT89	pnp 80V BCX53 hfe 100
AKAA	MAX810SXR	MAX	ZB	SOT23	microproc +ve reset gen 3.3V
AL	BCX53-16	Sie	P	SOT89	80V pnp BCX53 hfe 100
AL	MMBTA55L	Mot	N	SOT23	pnp 25V (MPSA55)
AL	ZMV933	Zet	I	SOD323	12-42pF hyperabrupt varicap
ALs	BFP405	Sie	MQ	SOT343	-
ALAA	MAX810SXR	MAX	ZB	SOT23	microproc +ve reset gen 3.0V
AM	MMBT3904W	Mot	N	SOT323	2N3904
AM	BCX52-16	Sie	P	SOT89	pnp 60V BCX52 hfe 160
AMs	BFP420	Sie	MQ	SOT343	npn fT 25GHz 4.5V 35mA
AM	BSS64	Mot	N	SOT23	npn 80V 0.1A fT 60MHz
AMs	BSS64	Sie	N	SOT23	npn 80V 0.1A fT 60MHz
AMp	BSS64	Phi	N	SOT23	npn 80V 0.1A fT 60MHz
AMt	BSS64	Phi	N	SOT23	npn 80V 0.1A fT 60MHz
AM	ZMV933A	Zet	I	SOD323	12-42pF hyperabrupt varicap
AN	BCW60FN	Sie	N	SOT23	gp npn 35V 0.2A
ANs	BFP450	Sie	MQ	SOT343	npn fT 25GHz 4.5V 100mA
AN	ZMV934	Zet	I	SOD323	25-95pF hyperabrupt varicap
AO	BCW60AR	ITT	R	SOT23R	BCY58-vii
AO	ZMV934A	Zet	I	SOD323	25-95pF hyperabrupt varicap
AP	BCW60BR	ITT	R	SOT23R	BCY58-viii
APs	BFP520	Sie	MQ	SOT343	npn fT 40GHz 2.5V 40mA
A-Q	2PD1820AQ	Phi	N	SOT323	gp sw amp 50V npn hfe 85-170
AtQ	2PD1820AQ	Phi	N	SOT323	gp sw amp 50V npn hfe 85-170
AR	BCW60CR	ITT	R	SOT23R	BCY58-ix
AR	MSD709R	Mot	N	-	pnp gp 25V
AR1	BSR40	Phi	P	SOT89	npn 70V 1A 1.35W hfe 40-120
AR2	BSR41	Phi	P	SOT89	npn 70V 1A 1.35W hfe 100-300
AR3	BSR42	Phi	P	SOT89	npn 90V 1A 1.35W hfe 40-120
AR4	BSR43	Phi	P	SOT89	npn 90V 1A 1.35W hfe 100-300
A-Q	2PD1820AR	Phi	N	SOT323	gp sw amp 50V npn hfe 120-240
AtQ	2PD1820AR	Phi	N	SOT323	gp sw amp 50V npn hfe 120-240
A-S	2PD1820AS	Phi	N	SOT323	gp sw amp 50V npn hfe 170-340
AtS	2PD1820AS	Phi	N	SOT323	gp sw amp 50V npn hfe 170-340
AS	BCW60DR	ITT	R	SOT23R	BCY58-x
AS	MSD709S	Mot	N	-	pnp gp 25V
ASs	BAT18-05	Sie	B	SOT23	dual BAT18 RF pin
AS1	BST50	Mot	P	SOT89	npn darlington 0.5A 60V
AS2	BST51	Mot	P	SOT89	npn darlington 0.5A 80V
AS3	BST52	Mot	P	SOT89	npn darlington 0.5A 90V
AS3	BSP52	Mot	P	SOT223	npn darlington 0.5A hfe 2000
ATs	BAT18-06	Sie	A	SOT23	dual ca BAT18 RF pin
ATs	BFP540	Sie	MQ	SOT343	npn microwave
AUs	BAT18-04	Sie	D	SOT23	dual BAT18 RF pin
AU	BCW60GR	ITT	R	SOT23R	BCY58
AV	DAN212K	Roh	C	-	80V 100mA sw
AW	BCW60HR	ITT	R	SOT23R	BCY58
AX	BCX70JR	ITT	R	SOT23R	BCY59-ix
AY	BCX70KR	ITT	R	SOT23R	BCY59-x
AY	MMBD1000	Mot	C	SOT23	Si sw diode 30V 0.2A

### Codes beginning with 'B'

Code	Device	Manufacturer	Base	Package	Leaded Equivalent/Data
B	MRF957	Mot	N	SOT323	npn RF fT 9GHz
B	BAS16-03W	Sie	I	SOD323	Varicap 18pF 1V
B	BB555	Sie	I	SCD80	Varicap 18pF 1V
B0	BZX399C4V3	Phi	I	SOD323	4.3V 0.3W zener
B0	HSMS-2810	HP	C	SOT23	HP2810 schottky
B0	HSMS-281B	HP	C	SOT323	HP2810 schottky
B08	SST6908	Sil	ZQ	-	2N6908 prot n-ch jfet
B09	SST6909	Sil	ZQ	-	2N6909 prot n-ch jfet

<b>B1</b>	BZX399C1V8	Phi	I	SOD323	1.8V 0.3W zener
<b>B1</b>	HSMS-2811	HP	K	SOT23	HP2811 schottky
<b>B1</b>	BAS40	Mot	C	SOT23	schottky sw diode
<b>B10</b>	SST6910	Sil	ZQ	-	2N6910 prot n-ch jfet
<b>B2</b>	BZX399C2V0	Phi	I	SOD323	2.0V 0.3W zener
<b>B2</b>	BSV52	Phi	N	SOT23	BSX20 12V fT 400MHz sw
<b>B2p</b>	BSV52	Phi	N	SOT23	BSX20 12V fT 400MHz sw
<b>B2t</b>	BSV52	Phi	N	SOT23	BSX20 12V fT 400MHz sw
<b>B2</b>	HSMS-2812	HP	D	SOT23	dual HP2810 schottky
<b>B2</b>	HSMS-281C	HP	D	SOT323	dual HP2810 schottky
<b>B3</b>	BZX399C2V2	Phi	I	SOD323	2.2V 0.3W zener
<b>B3</b>	HSMS-2813	HP	A	SOT23	dual ca HP2810 schottky
<b>B3</b>	MMBD717L	Mot	A	SOT323	dual ca schottky
<b>B4</b>	BZX399C2V4	Phi	I	SOD323	2.4V 0.3W zener
<b>B4</b>	BSV52R	Phi	R	SOT23R	BSX20
<b>B4</b>	HSMS-2814	HP	B	SOT23	dual cc HP2810 schottky
<b>B5</b>	BZX399C2V7	Phi	I	SOD323	2.7V 0.3W zener
<b>B5</b>	HSMS-2815	HP	S	SOT143	dual HP2810 schottky
<b>B6</b>	BZX399C3V0	Phi	I	SOD323	3.0V 0.3W zener
<b>B6</b>	BAT54A	Mot	A	SOT23	dual ca 30V schottky
<b>B7</b>	BZX399C3V3	Phi	I	SOD323	3.3V 0.3W zener
<b>B7</b>	HSMS-2817	HP	RQ	SOT143	HP2810 ring quad
<b>B8</b>	BZX399C3V6	Phi	I	SOD323	3.6V 0.3W zener
<b>B8</b>	HSMS-2818	HP	BQ	SOT143	HP2810 bridge quad
<b>B9</b>	BZX399C3V9	Phi	I	SOD323	3.9V 0.3W zener
<b>B9</b>	2SC4617	Mot	N	SC90	npn gp
<b>B26</b>	BF570	Phi		SOT23	-
<b>BA</b>	BCX54	Sie	P	SOT89	npn AF 45V comp BCX51
<b>BA</b>	BCW61A	Phi	N	SOT23	BCY78-vii
<b>BAp</b>	BCW61A	Phi	N	SOT23	BCY78-vii
<b>BAt</b>	BCW61A	Phi	N	SOT23	BCY78-vii
<b>BA</b>	DAN217	Roh	D	-	80V 100mA dual
<b>BA</b>	BZX399C4V7	Phi	I	SOD323	4.7V 0.3W zener
<b>BB</b>	BCW61B	Phi	N	SOT23	BCY78-viii
<b>BBs</b>	BCW61B	Sie	N	SOT23	BCY78-viii
<b>BBp</b>	BCW61B	Phi	N	SOT23	BCY78-viii
<b>BBt</b>	BCW61B	Phi	N	SOT23	BCY78-viii
<b>BB</b>	BAR81	Sie	NQ	SOT143	Dual pin shunt switch
<b>BB</b>	BZX399C5V1	Phi	I	SOD323	5.1V 0.3W zener
<b>BBs</b>	BAR81W	Sie	NQ	SOT343	Dual pin shunt switch
<b>BC</b>	BCW61C	Phi	N	SOT23	BCY78-ix
<b>BCs</b>	BCW61C	Sie	N	SOT23	BCY78-ix
<b>BC</b>	BCX54-10	Sie Phi	P	SOT89	npn hfe100
<b>BC</b>	BZX399C5V6	Phi	I	SOD323	5.6V 0.3W zener
<b>BCp</b>	BCW61C	Phi	N	SOT23	BCY78-ix
<b>BCt</b>	BCW61C	Phi	N	SOT23	BCY78-ix
<b>BD</b>	BCW61D	Phi	N	SOT23	BCY78-x
<b>BDs</b>	BCW61D	Sie	N	SOT23	BCY78-x
<b>BDp</b>	BCW61D	Phi	N	SOT23	BCY78-x
<b>BDt</b>	BCW61D	Phi	N	SOT23	BCY78-x
<b>BD</b>	BCX54-16	Sie	P	SOT89	npn hfe160 comp BCX51-16
<b>BD</b>	BZX399C6V2	Phi	I	SOD323	6.2V 0.3W zener
<b>BD</b>	ZHCS400	Zet	E	SOT23	40V 0.4A schottky diode
<b>BE</b>	BAS70	Mot	C	SOT23	schottky sw diode
<b>BE</b>	BCX55	Sie	P	SOT89	npn AF 60V comp BCX52
<b>BE</b>	BZX399C6V8	Phi	I	SOD323	6.8V 0.3W zener
<b>BF</b>	BCW61FF	Sie	N	SOT23	low noise BCW61
<b>BF</b>	BZX399C7V5	Phi	I	SOD323	7.5V 0.3W zener
<b>BG</b>	BCX71G	Phi	N	SOT23	BCY79-vii
<b>BGs</b>	BCX71G	Sie	N	SOT23	BCY79-vii
<b>BGp</b>	BCX71G	Phi	N	SOT23	BCY79-vii
<b>BGt</b>	BCX71G	Phi	N	SOT23	BCY79-vii
<b>BG</b>	BCX55-10	Sie Phi	P	SOT89	npn hfe 100
<b>BG</b>	BZX399C8V2	Phi	I	SOD323	8.2V 0.3W zener

<b>BH</b>	BCX71H	Phi	N	SOT23	BCY79-viii
<b>BHs</b>	BCX71H	Sie	N	SOT23	BCY79-viii
<b>BHp</b>	BCX71H	Phi	N	SOT23	BCY79-viii
<b>BHt</b>	BCX71H	Phi	N	SOT23	BCY79-viii
<b>BH</b>	BCP56	Mot	P	SOT223	npn amp 80V 150mA
<b>BH</b>	BCX56	Sie	P	SOT89	npn AF 80V
<b>BH</b>	BZX399C9V1	Phi	I	SOD323	9.1V 0.3W zener i
<b>BJ</b>	BCX71J	Phi	N	SOT23	BCY79-ix
<b>BJs</b>	BCX71J	Sie	N	SOT23	BCY79-ix
<b>BJp</b>	BCX71J	Phi	N	SOT23	BCY79-ix
<b>BJt</b>	BCX71J	Phi	N	SOT23	BCY79-ix
<b>BJ</b>	BZX399C10	Phi	I	SOD323	10V 0.3W zener
<b>BK</b>	BCP56-10	Mot	P	SOT223	npn amp 80V 150mA
<b>BK</b>	BCX71K	Phi	N	SOT23	BCY79
<b>BKs</b>	BCX71K	Sie	N	SOT23	BCY79
<b>BKp</b>	BCX71K	Phi	N	SOT23	BCY79
<b>BKt</b>	BCX71K	Phi	N	SOT23	BCY79
<b>BK</b>	BCX56-10	Sie	P	SOT89	npn hfe 100
<b>BK</b>	BZX399C11	Phi	I	SOD323	11V 0.3W zener
<b>BL</b>	MBS54DW	Mot	DL	SOT363	2x schottky detector diodes
<b>BL</b>	BCP56-16	Mot	P	SOT223	npn amp 80V 150mA
<b>BL</b>	BCX56-16	Sie	P	SOT89	npn hfe 160
<b>BL</b>	BZX399C12	Phi	I	SOD323	12V 0.3W zener
<b>BL</b>	BGA310	Sie	GQ	SOT143	MMIC amp 9dB @ 1GHz
<b>BLs</b>	BGA420	Sie	HQ	SOT343	MMIC amp 13 dB @ 1.8GHz
<b>BM</b>	BSS63L	Mot	N	SOT23	100v pnp comp BSS64
<b>BMp</b>	BSS63	Phi	N	SOT23	100v pnp comp BSS64
<b>BMt</b>	BSS63	Phi	N	SOT23	100v pnp comp BSS64
<b>BM</b>	BCX55-16	Sie	P	SOT89	npn hfe 160
<b>BM</b>	BGA312	Sie	GQ	SOT143	MMIC amp 11dB @ 1GHz
<b>BM</b>	BZX399C13	Phi	I	SOD323	13V 0.3W zener
<b>BMs</b>	BG427	Sie	HQ	SOT343	MMIC amp 18 dB @ 1.8GHz
<b>BNs</b>	BCW61FN	Sie	N	SOT23	low noise BCW61
<b>BN</b>	BZX399C15	Phi	I	SOD323	15V 0.3W zener
<b>BN</b>	BGA318	Sie	GQ	SOT143	MMIC amp 16dB @ 1GHz
<b>BO</b>	BCW61AR	Phi	N	SOT23	BCX78, BCY78-vii
<b>BP</b>	BCW61BR	Phi	N	SOT23	BCY78-viii
<b>BP</b>	BZX399C16	Phi	I	SOD323	16V 0.3W zener
<b>BQ</b>	BZX399C18	Phi	I	SOD323	18V 0.3W zener in SOD323
<b>BQ</b>	2PB709AQ	Phi	N	SC-59	PNP 45V 0.1A hfe 160-260
<b>BR</b>	BCW61CR	Phi	N	SOT23	BCY78-ix
<b>BR</b>	2SC2412K	Roh	N	-	npn 50V 150mA min hfe 180
<b>BR</b>	2SC4081	Roh	N	UMT	2SC2412K above
<b>BR</b>	2SC4617	Roh	N	EM3	2SC2412K above
<b>BR</b>	MSB1218A	Mot	N	SOT323	gp pnp 45V
<b>BR</b>	BZX399C20	Phi	I	SOD323	20V 0.3W zener
<b>BR</b>	2PB709AR	Phi	N	SC-59	pnp45V 0.1A hfe 210-340
<b>BR1</b>	BSR30	Phi	P	SOT89	pnp 70V 1A 1.35W hfe 40-120
<b>BR2</b>	BSR31	Phi	P	SOT89	pnp 70V 1A 1.35W hfe 100-300
<b>BR4</b>	BSR33	Phi	P	SOT89	pnp 90V 1A 1.35W hfe 100-300
<b>BS</b>	BCW61DR	Phi	R	SOT23	BCY78-x
<b>BS</b>	BZX399C22	Phi	I	SOD323	22V 0.3W zener
<b>BS</b>	2PB709AS	Phi	N	SC-59	pnp 45V 0.1A hfe 290-460
<b>BS1</b>	BST60	Mot	P	SOT89	pnp darlington 0.5A 60V
<b>BS2</b>	BST61	Mot	P	SOT89	pnp darlington 0.5A 80V
<b>BS3</b>	BST62	Mot	P	SOT89	pnp darlington 0.5A 90V
<b>BS3</b>	BSP62	Mot	P	SOT89	pnp darlington 0.5A hfe 2000
<b>BT</b>	BZX399C24	Phi	I	SOD323	24V 0.3W zener
<b>BT2</b>	BSP16	Mot	P	SOT223	pnp -300V 1A
<b>BT2</b>	BST16	Phi	P	SOT89	pnp -300V 1A
<b>BU</b>	BCX71GR	Phi	N	SOT23	BCX79-vii
<b>BU</b>	BZX399C27	Phi	I	SOD323	27V 0.3W zener
<b>BV</b>	BZX399C30	Phi	I	SOD323	30V 0.3W zener
<b>BW</b>	BCW71HR	Phi	N	SOT23R	BCX79-viii
<b>BW</b>	BZX399C33	Phi	I	SOD323	33V 0.3W zener

<b>BX</b>	BCW71JR	Phi	N	SOT23R	BCX79-ix
<b>BX</b>	BZX399C36	Phi	I	SOD323	36V 0.3W zener
<b>BY</b>	BCW71KR	Phi	N	SOT23R	BCX79-x
<b>BY</b>	BZX399C39	Phi	I	SOD323	39V 0.3W zener
<b>BZ</b>	BZX399C43	Phi	I	SOD323	43V 0.3W zener

### Codes beginning with 'C'

Code	Device	Manufacturer	Base	Package	Leaded Equivalent/Data
<b>C</b>	BB565	Sie	I	SCD80	uhf varicap 2-20pF
<b>C white</b>	BAT165	Sie	I	-	40V 750mA sw Schottky
<b>C</b>	KV1832E	Tok	I	URD	uhf varicap 4-17pf
<b>C0</b>	HSMS-2820	HP	C	SOT23	HP2835 schottky
<b>C0</b>	HSMS-282B	HP	C	SOT323	HP2835 schottky
<b>C1</b>	HSMS-2821	HP	K	SOT23	HP2835 schottky
<b>C1</b>	BCW29	Phi	N	SOT23	BC178A
<b>C1p</b>	BCW29	Phi	N	SOT23	BC178A
<b>C1t</b>	BCW29	Phi	N	SOT23	BC178A
<b>C1</b>	BFQ51C	Phi	CX	SOT173	pnnp BFR90A complement
<b>C2</b>	BCW30	Phi	N	SOT23	BC178B
<b>C2p</b>	BCW30	Phi	N	SOT23	BC178B
<b>C2t</b>	BCW30	Phi	N	SOT23	BC178B
<b>C2</b>	BFQ32C	Phi	CX	SOT173	pnnp 4.5GHz 15V 100mA
<b>C2</b>	HSMS-2822	HP	D	SOT23	dual HP2835 schottky
<b>C2</b>	HSMS-282C	HP	D	SOT323	dual HP2835 schottky
<b>C2</b>	SST112	Tem	F	SOT23	J112 analog sw n-ch jfet
<b>C2A</b>	ZDC833A	Zet	B	SOT23	dual cc 28V varicap 15pF @2V
<b>C3</b>	HSMS-2823	HP	A	SOT23	dual HP2835 schottky
<b>C3</b>	BFQ23C	Phi	CX	SOT173	pnnp complement BFP91A
<b>C3</b>	SBMT4126	Sie	N	-	2N4126
<b>C3</b>	SST113	Tem	F	SOT23	J113 analog sw jfet
<b>C4</b>	BCW29R	Phi	R	SOT23R	BC178A
<b>C4</b>	HSMS-2824	HP	B	SOT23	dual HP2835 schottky
<b>C5</b>	MMBA811C5	Mot	N	-	2N5086 pnp hfe 135-270
<b>C5</b>	BCW30R	Phi	R	SOT23R	BC178B
<b>C5</b>	HSMS-2825	HP	S	SOT143	dual HP2835 schottky
<b>C5A</b>	ZDC834A	Zet	B	SOT23	dual cc 28V varicap 47pF @2V
<b>C6</b>	MMBA811C6	Mot	N	-	2N5086 pnp hfe 200-400
<b>C7</b>	MMBA811C7	Mot	N	-	2N5086 pnp hfe 300-600
<b>C7</b>	HSMS-2827	HP	RQ	SOT143	HP2835 ring quad
<b>C8</b>	HSMS-2828	HP	BQ	SOT143	HP2835 bridge quad
<b>C8</b>	BCF30	SGS	N	SOT23	BC559B
<b>C8</b>	MMBA811C8	Mot	N	-	2N5086 pnp hfe 450-900
<b>C11</b>	SST111	Sil	F	SOT23	J111 n-ch fet
<b>C12</b>	SST112	Sil	F	SOT23	J112 n-ch fet
<b>C13</b>	SST113	Sil	F	SOT23	J113 n-ch fet
<b>C38</b>	SST5638	Sil	F	SOT23	2N5638
<b>C39</b>	SST5639	Sil	F	SOT23	2N5639
<b>C40</b>	SST5640	Sil	F	SOT23	2N5640
<b>C41</b>	SST4091	Sil	F	SOT23	2N4091
<b>C42</b>	SST4092	Sil	F	SOT23	2N4092
<b>C43</b>	SST4093	Sil	F	SOT23	2N4093
<b>C56</b>	SST4856	Sil	F	SOT23	2N4856
<b>C57</b>	SST4857	Sil	F	SOT23	2N4857
<b>C58</b>	SST4858	Sil	F	SOT23	2N4858
<b>C59</b>	SST4859	Sil	F	SOT23	2N4859
<b>C60</b>	SST4860	Sil	F	SOT23	2N4860
<b>C61</b>	SST4861	Sil	F	SOT23	2N4861
<b>C91</b>	SST4391	Sil	F	SOT23	2N4391
<b>C92</b>	SST4392	Sil	F	SOT23	2N4392
<b>C93</b>	SST4393	Sil	F	SOT23	2N4393
<b>CA</b>	BCW61AR	Phi	R	SOT23R	BCY78-vii
<b>CA</b>	BCP68	Mot	P	SOT223	20V 1A npn
<b>CA</b>	ZMV829B	Zet	I	SOD323	varicap hyperab 28V 8.2pF@2V

<b>CB</b>	BCX68-10	Sie	P	SOT89	npn AF 20V 2A hfe 100
<b>CB</b>	BCW61BR	Phi	R	SOT23R	BCY78-viii
<b>CB</b>	ZMV830B	Zet	I	SOD323	varicap hyperabrupt 28V 10pF@2V
<b>CC</b>	BCW61CR	Phi	R	SOT23R	BCY78-ix
<b>CC</b>	BCX68-16	Sie	P	SOT89	npn AF 20V 2A hfe 160
<b>CC</b>	ZMV831B	Zet	I	SOD323	varicap hyperabrupt 28V 15pF@2V
<b>CC</b>	ZMDC831B	Zet	B	SOT323	dual cc ZMV831B (above)
<b>CD</b>	BCW61DR	Phi	R	SOT23R	BCY78-x
<b>CD</b>	BCX68-25	Sie	P	SOT89	npn AF 20V 2A hfe 250
<b>CD</b>	ZMV832B	Zet	I	SOD323	varicap hyperabrupt 28V 22pF@2V
<b>CD</b>	ZMDC832B	Zet	B	SOT323	dual cc ZMV832B (above)
<b>CDs</b>	BSS81B	Sie	N	SOT23	npn sw 35V 0.8A
<b>CE</b>	BCP69	Mot	P	SOT223	20V 1A pnp
<b>CE</b>	ZMV833B	Zet	I	SOD323	varicap hyperabrupt 28V 33pF@2V
<b>CEs</b>	BSS79B	Sie	N	SOT23	npn 40V 0.8A hfe 40-120
<b>CF</b>	BSS79C	Sie	N	SOT23	npn 40V 0.8A hfe 100 min
<b>CF</b>	BCX69-10	Sie	P	SOT89	pnp AF 20V 2A hfe 100
<b>CF</b>	ZMV834B	Zet	I	SOD323	varicap hyperabrupt 28V 47pF@2V
<b>CG</b>	BCX71GR	Phi	R	SOT23R	BCY79-vii
<b>CG</b>	BCX69-16	Sie	P	SOT89	pnp AF 20V 2A hfe 160
<b>CG</b>	ZMV835B	Zet	I	SOD323	varicap hyperabrupt 28V 68pF@2V
<b>CGs</b>	BSS81C	Sie	N	SOT23	npn sw 35V 1A
<b>CHs</b>	BSS80B	Sie	N	SOT23	pnp 40V 0.8A hfe 40-120
<b>CH</b>	BSS82BL	Mot	N	SOT23	pnp 60V
<b>CH</b>	BCX69-25	Sie	N	SOT89	pnp AF 20V 2A hfe 250
<b>CJs</b>	BSS80C	Sie	N	SOT23	pnp 40V 0.8A hfe 100 min
<b>CK</b>	BCX71JR	Phi	R	SOT23R	BCY79-viii
<b>CLs</b>	BSS82B	Sie	N	SOT23	pnp 60V 0.8A hfe 40-120
<b>CMs</b>	BSS82C	Sie	N	SOT23	pnp 60V 0.8A hfe 100 min
<b>CQ</b>	2SC2411K	Roh	N	-	npn darlington
<b>CQ</b>	MSD710Q	Mot	N	SOT346	pnp gp 25V 150mA
<b>CR</b>	MSD701R	Mot	N	SOT346	pnp gp 25V 150mA

### Codes beginning with 'D'

Code	Device	Manufacturer	Base	Package	Leaded Equivalent/Data
<b>D</b>	BB659	Sie	I	SCD80	2-38p varicap
<b>D</b>	BAS21-03W	Sie	I	SOD323	-
<b>D</b>	1SS376	Roh	I	USM	300V 50mA sw
<b>D</b>	MRF577	Mot	N	SOT323	npn RF fT 7GHz
<b>D0</b>	HSMP-3800	HP	C	SOT23	HP3800 pin atten diode
<b>D1</b>	BCW31	Phi	N	SOT23	BC108A
<b>D1p</b>	BCW31	Phi	N	SOT23	BC108A
<b>D1t</b>	BCW31	Phi	N	SOT23	BC108A
<b>D1</b>	HSMP-3801	HP	K	-	HP3800 pin atten diode
<b>D1</b>	SST211	Tem	XQ	-	n-ch mosfet 30V 1nS
<b>D2</b>	BCW32	Phi	N	SOT23	BC108B
<b>D2p</b>	BCW32	Phi	N	SOT23	BC108B
<b>D2t</b>	BCW32	Phi	N	SOT23	BC108B
<b>D2</b>	HSMP-3802	HP	D	-	dual HP3800 pin atten diode
<b>D3</b>	BCW33	Phi	N	SOT23	BC108C
<b>D3p</b>	BCW33	Phi	N	SOT23	BC108C
<b>D3t</b>	BCW33	Phi	N	SOT23	BC108C
<b>D3B</b>	RB420D	Roh	C	-	25V 100mA schottky
<b>D3E</b>	RB411D	Roh	C	SOT23	20V 500mA schottky
<b>D3J</b>	RB420D	Roh	C	-	25V 100mA schottky
<b>D3L</b>	RB706D-40	Roh	B	-	dual 45V 30mA schottky
<b>D4</b>	BCW31R	Phi	R	SOT23R	BC108A
<b>D4</b>	HSMP-3804	HP	B	SOT23	dual cc HP3800 pin atten diode

D5	SST215	Tem	XQ	-	n-ch mosfet 20V 1nS
D5	BCW32R	Phi	R	SOT23R	BC108B
D6	BCW33R	Phi	R	SOT23R	BC108C
D6	MMBC1622D6	Mot	N	-	MPS3904 hfe 200-400
D7p	BCF32	Phi	N	SOT23	-
D7t	BCF32	Phi	N	SOT23	-
D7	MMBC1622D7	Mot	N	-	MPS3904 hfe 300-600
D8p	BCF33	Phi	N	SOT23	BC146/03
D11	SST211	Sil	XQ	-	n-ch mosfet sw
D13	SST213	Sil	XQ	-	n-ch mosfet sw
D11	SST215	Sil	XQ	-	n-ch mosfet sw
D58	FLLD261	Zet	B	SOT23	low leakage dual cc Si diode
D63	FLLD263	Zet	A	SOT23	low leakage dual ca Si diode
D76	BAR18J	SGS	I	SOD232	schottky 70V 15mA
D76	BAR18	SGS	C	SOT23	schottky 70V 30mA
D85	BAT17DS	SGS	D	-	2xBA481
D86	BAT54J	ST	I	SOD232	schottky 30V 300mA
D86	BAT54	ST	C	SOT23	schottky 30V 300mA
D87	BAT54C	ST	B	SOT23	dual cc schottky 30V 300mA
D88	BAT54S	ST	D	SOT23	dual series schottky 30V 300mA
D94	BAR42	SGS	C	SOT23	schottky 30V 100mA
D95	BAR43	SGS	C	SOT23	schottky 30V 100mA
D96	BAS70-04	SGS	D	SOT23	2xBA18
D97	BAS70-05	SGS	B	SOT23	2xBA18
D98	BAS70-06	SGS	A	SOT23	2xBA18
DA	BCW67A	SGS	N	SOT23	npn 32V 0.8A hfe 100 min
DA	BF622	Sie	P	SOT89	npn 250V video o/p
DA5	BAR43S	SGS	D	SOT23	2xBA43
DB	BCW67B	SGS	N	SOT23	npn 32V 0.8A hfe 160 min
DB	BF623	Sie	P	SOT89	npn 250V video o/p
DB1	BAR43A	SGS	A	SOT23	2xBA43
DB2	BAR43C	SGS	B	SOT23	2xBA43
DC	BCW67C	SGS	N	SOT23	npn 32V 0.8A hfe 250 min
DC	BF720	Mot	P	SOT223	npn 1.5W 300V
DC	BFN20	Sie	P	SOT89	npn video o/p 300V comp BFN21
DD	BFN16	Sie	P	SOT89	npn video o/p 250V comp BFN17
DE	BFN18	Sie	P	SOT89	npn video o/p 300V comp BFN19
DF	BCW68F	SGS	N	SOT23	npn 45V 0.8A hfe 100 min
DF	BF721	Mot	P	SOT223	npn 1.5W 300V
DF	BFN21	Sie	P	SOT89	npn 300V video o/p comp BFN20
DG	BCW68G	SGS	N	SOT23	npn 45V 0.8A hfe 160 min
DG	BFN17	Sie	P	SOT89	npn video o/p 250V comp BFN16
DH	BCW68H	SGS	N	SOT23	npn 45V 0.8A hfe 250 min
DH	BCW68G	Mot	N	SOT23	npn 45V 0.8A hfe 160 min
DH	MMBD2000	Mot	C	SOT323	Si sw diode 20V 0.2A SOT323
DH	BFN19	Sie	P	SOT89	npn video o/p 300V comp BFN18
DK	BCX42	Sie	N	SOT23	gp audio npn 125V comp BCX41
DP	MMBD2010	Mot	B	SOT323	dual cc MMBD2000
DQ	2P710AQ	Phi	N	SOT346	gp npn hfe 85-170
DR	2P710AR	Phi	N	SOT346	gp npn hfe 120-240
DS	2P710AS	Phi	N	SOT346	gp npn hfe 170-340
DT	BCW67AR	SGS	R	SOT23R	npn 32V 0.8A hfe 100 min
DU	BCW67BR	SGS	R	SOT23R	npn 32V 0.8A hfe 160 min
DW	BCW67CR	SGS	R	SOT23R	npn 32V 0.8A hfe 250 min
DX	BCW68FR	SGS	R	SOT23R	npn 45V 0.8A hfe 100 min
DY	BCW68GR	SGS	R	SOT23R	npn 45V 0.8A hfe 160 min
DZ	BCW68HR	SGS	R	SOT23R	npn 45V 0.8A hfe 250 min

### Codes beginning with 'E'

Code	Device	Manufacturer	Base	Package	Leaded Equivalent/Data
e	BAT64-02W	Sie	I	SCD80	-
E	1SS780	Roh	I	USM	40V 100mA lo leakage
E	BB689	Sie	I	SCD80	2-55pF varicap

E0	HSMP-3810	HP	C	SOT23	HP3810 pin atten diode
E0	HSMP-381B	HP	C	SOT323	HP3810 pin atten diode
E01	DTDG14EP	Roh	P	SOT89	npn dtr 60V 1A R2 10k, + c to b zener
E02	DTDG23YP	Roh	P	SOT89	npn dtr 60V 1A 2k2+ 10k, + c to b zener
E1p	BFS17	Phi	N	SOT23	BFY90 BFW92
E1p	BFS17W	Phi	N	SOT323	BFY90 BFW92
E1	HSMP-3811	HP	K	SOT23	HP3810 pin atten diode
E2	BFS17A	Phi	N	SOT23	npn RF 3GHz 25mA
E2	BAL99	Zet	C	-	sw diode 75V 100mA
E2	HSMP-3812	HP	D	SOT23	dual series HP3810 pin atten diode
E3	BAR99	Zet	C	-	sw diode 75V 100mA
E3	HSMP-3813	HP	A	SOT23	dual HP3810 pin atten diode
E4	BFS17R	Phi	R	-	BFY90 BFW92
E4	HSMP-3814	HP	B	SOT23	dual cc HP3810 pin atten diode
E5	BFS17AR	Tfk	R	-	npn rf 3 GHz 25mA
E6	ZC2800E	Zet	C	-	HP2800
E8	ZC2811E	Zet	C	-	HP2811
E9	ZC5800E	Zet	C	-	HP5800
E11	DTA113ZE	Roh	N	EMT3	pnp dtr 1k0 + 10k 50V 100mA
E11	DTA113ZKA	Roh	N	SC59	pnp dtr 1k0 + 10k 50V 100mA
E13	DTA143ZE	Roh	N	EMT3	pnp dtr 4k7 + 47k 50V 100mA
E13	DTA143ZKA	Roh	N	SC59	pnp dtr 4k7 + 47k 50V 100mA
E23	DTC143ZCA	Roh	N	SOT23	npn dtr 4k7 + 47k 50V 100mA
E23	DTC143ZE	Roh	N	EMT3	npn dtr 4k7 + 47k 50V 100mA
E23	DTC143ZKA	Roh	N	SC59	npn dtr 4k7 + 47k 50V 100mA
E32	DTA123JE	Roh	N	EMT3	pnp dtr 2k2 + 47k 50V 100mA
E32	DTA123JKA	Roh	N	SC59	pnp dtr 2k2 + 47k 50V 100mA
E42	DTC123JE	Roh	N	EMT3	npn dtr 2k2 + 47k 50V 100mA
E42	DTC123JKA	Roh	N	SC59	npn dtr 2k2 + 47k 50V 100mA
E56	DTA144VKA	Roh	N	SC59	pnp dtr 47k + 10k 50V 100mA
E66	DTC144VKA	Roh	N	SC59	npn dtr 47k + 10k 50V 100mA
EAs	BCW65A	Sie	N	SOT23	npn 32V 800mA hfe 100 min
EBs	BCW65B	Sie	N	SOT23	npn 32V 800mA hfe 160 min
EB	HSMP-4810	HP	J	SOT23	0.5-3GHz pin 2 cathode connections
EB	MSC1022-B	Mot	H	-	pnp RF 150MHz fT 20V
EC	MSC1022-C	Mot	H	-	pnp RF 150MHz fT 20V
ECs	BCW65C	Sie	N	SOT23	npn 32V 800mA hfe 250 min
ED	BCV28	Sie	P	SOT89	pnp darlington 30V 0.8A comp BCV29
EE	BCV48	Sie	P	SOT89	pnp darlington 60V 0.8A comp BCV49
EF	BCV29	Sie	P	SOT89	npn darlington 30V 0.8A comp BCV28
EF	BCW66F	Sie	N	SOT23	npn 45V 800mA hfe 100 min
EG	BCV49	Sie	P	SOT89	npn darlington 60V 0.8A comp BCV48
EGs	BCW66G	Sie	N	SOT23	npn 45V 800mA hfe 160 min
EHs	BCW66H	Sie	N	SOT23	npn 45V 800mA hfe 240 min
EHAA	MAX6326_R22-T	Max	ZB	SOT23	microproc -ve reset gen 2.200V
EIAA	MAX6327_R22-T	Max	ZB	SOT23	microproc +ve reset gen 2.200V
EJAA	MAX6328_R22-T	Max	ZB	SOT23	microproc -ve reset gen 2.200V
EKs	BCX41	Sie	N	SOT23	gp npn 125V 1A comp BCX42
ET	BCW65AR	Sie	R	SOT23R	npn 32V 800mA hfe 100 min
EU	BCW65BR	Sie	R	SOT23R	npn 32V 800mA hfe 160 min
EW	BCW65CR	Sie	R	SOT23R	npn 32V 800mA hfe 240 min
EWAA	MAX6326_R23-T	Max	ZB	SOT23	microproc -ve reset gen 2.320V
EX	BCW65FR	Sie	R	SOT23R	npn 45V 800mA hfe 100 min
EXAA	MAX6326_R24-T	Max	ZB	SOT23	microproc -ve reset gen 2.400V
EY	BCW65GR	Sie	R	SOT23R	npn 45V 800mA hfe 160 min
EYAA	MAX6326_R25-T	Max	ZB	SOT23	microproc -ve reset gen 2.500V
EZ	BCW65HR	Sie	R	SOT23R	npn 45V 800mA hfe 240 min
EZAA	MAX6326_R26-T	Max	ZB	SOT23	microproc -ve reset gen 2.630V

### Codes beginning with 'F'

Code	Device	Manufacturer	Base	Package	Leaded Equivalent/Data
f	BAS20-02W	Sie	I	SCD80	-
F	KV1831E	Tok	I	URD	uhf varicap 2.5-22pf



<b>F</b>	MRF927	Mot	N	SOT323	npn RF fT 8GHz
<b>F0</b>	HSMP-3820	HP	C	SOT23	35V RF pin sw diode
<b>F02</b>	DTD123TK	Roh	N	SC59	npn dtr R1 2k2 40V 100mA
<b>F03</b>	DTD143TK	Roh	N	SC59	npn dtr R1 4k7 40V 100mA
<b>F05</b>	TSDF1205	Tfk	X	-	fT 12GHz npn RF 4V 12mA
<b>F1</b>	HSMP-3821	HP	K	SOT23	35V RF pin sw diode
<b>F1</b>	BFS18	Phi	N	SOT23	BF495
<b>F1</b>	MMBC1009F1	Mot	N	-	RF npn fT 150MHz hfe30-60
<b>F2</b>	HSMP-3822	HP	D	SOT23	dual series HP3820 pin sw diode
<b>F2</b>	BFS19	SGS	N	SOT23	BF184 BF494
<b>F2p</b>	BFS19	Phi	N	SOT23	BF184 BF494
<b>F2t</b>	BFS19	Phi	N	SOT23	BF184 BF494
<b>F3</b>	MMBC1009F3	Mot	N	-	RF npn fT150MHz hfe60-120
<b>F4</b>	BFS18R	Phi	N	-	BF495
<b>F4</b>	HSMP-3824	HP	B	SOT23	dual cc HP3820 pin sw diode
<b>F5</b>	BFS19R	Phi	N	-	BF184 BF494
<b>F8p</b>	BF824	Phi	N	SOT23	-
<b>F8t</b>	BF824	Phi	N	SOT23	-
<b>F8t</b>	BF824W	Phi	N	SOT323	-
<b>F11</b>	DTB113EK	Roh	N	SC59	npn dtr 1k + 1k 50V 500mA
<b>F12</b>	DTB123EK	Roh	N	SC59	npn dtr 2k2 + 2k2 50V 500mA
<b>F13</b>	DTB143EK	Roh	N	SC59	npn dtr 4k7 + 4k7 50V 500mA
<b>F13</b>	DTB143EC	Roh	N	SOT23	npn dtr 4k7 + 4k7 50V 500mA
<b>F13</b>	DTB143EK	Roh	N	SC59	npn dtr 4k7 + 4k7 50V 500mA
<b>F14</b>	DTB114EK	Roh	N	SC59	npn dtr 10k + 10k 50V 500mA
<b>F20</b>	TSDF1220	Tfk	X	-	fT 12GHz npn 6V 20mA
<b>F21</b>	DTD113EK	Roh	N	SC59	npn dtr 1k + 1k 50V 500mA
<b>F22</b>	DTD123EK	Roh	N	SC59	npn dtr 2k2 + 2k2 50V 500mA
<b>F23</b>	DTD143EK	Roh	N	SC59	npn dtr 4k7 + 4k7 50V 500mA
<b>F23</b>	DTD143EC	Roh	N	SOT23	npn dtr 4k7 + 4k7 50V 500mA
<b>F23</b>	DTD143EK	Roh	N	SC59	npn dtr 4k7 + 4k7 50V 500mA
<b>F24</b>	DTD114EK	Roh	N	SC59	npn dtr 10k + 10k 50V 500mA
<b>F52</b>	DTB123YC	Roh	N	SOT23	npn dtr 2k2 + 10k 50V 100mA
<b>F52</b>	DTB123YK	Roh	N	SC59	npn dtr 2k2 + 10k 50V 100mA
<b>F62</b>	DTD123YK	Roh	N	SC59	npn dtr 2k2 + 10k 50V 100mA
<b>F92</b>	DTB123TK	Roh	N	SC59	npn dtr R1 2k2 40V 100mA
<b>F93</b>	DTB143TK	Roh	N	SC59	npn dtr R1 4k7 40V 100mA
<b>F94</b>	DTB114TK	Roh	N	SC59	npn dtr R110k 40V 100mA
<b>FA</b>	HSMP-4820	HP	B	SOT23	0.5-3GHz cc pin dual anode
<b>FA</b>	BFQ17	Phi	P	SOT89	npn RF 1.5GHz 300mA
<b>FA</b>	BFP81	Sie	X	-	BFQ69
<b>FA</b>	BFQ19	Phi	P	SOT89	npn RF Ft 5.5GHz 100mA
<b>FAAA</b>	MAX6326_R27-T	Max	ZB	SOT23	microproc -ve reset gen 2.700V
<b>FB</b>	BFP17	Sie	X	-	BFW92
<b>FBAA</b>	MAX6328_R31-T	Max	ZB	SOT23	microproc -ve reset gen 2.800V
<b>FC</b>	BFQ64	Sie	P	-	BFT98T
<b>FC</b>	BFP29	Sie	X	-	BFT97
<b>FCAA</b>	MAX6326_R29-T	Max	ZB	SOT23	microproc -ve reset gen 2.930V
<b>FD</b>	BCV26	SGS	N	SOT23	npn darlington
<b>FDp</b>	BCV26	Phi	N	SOT23	npn darlington
<b>FDt</b>	BCV26	Phi	N	SOT23	npn darlington
<b>FD</b>	BFQ17P	Sie	P	SOT89	BFW16A
<b>FD</b>	BFP35A	Sie	X	-	BFR34A
<b>FDAA</b>	MAX6326_R31-T	Max	ZB	SOT23	microproc -ve reset gen 3.080V
<b>FE</b>	BCV46	SGS	N	SOT23	npn darlington
<b>FEp</b>	BCV46	Phi	N	SOT23	npn darlington
<b>FEt</b>	BCV46	Phi	N	SOT23	npn darlington
<b>FEs</b>	BFQ19P	Sie	P	SOT89	BFR96
<b>FE</b>	BFP93A	Sie	X	SOT143	BFR91A
<b>FEAA</b>	MAX6326_R30-T	Max	ZB	SOT23	microproc -ve reset gen 3.000V
<b>FF</b>	BCV27	SGS	N	SOT23	npn darlington
<b>FF</b>	BBY65-02V	Inf	I	SC79	hyperabrupt varicap 2.7-30pF
<b>FFp</b>	BCV27	Phi	N	SOT23	npn darlington
<b>FFt</b>	BCV27	Phi	N	SOT23	npn darlington
<b>FFAA</b>	MAX6327_R23-T	Max	ZB	SOT23	microproc +ve reset gen 2.320V
<b>FG</b>	BCV47	Phi	N	SOT23	npn darlington
<b>FGp</b>	BCV47	Phi	N	SOT23	npn darlington

<b>FGt</b>	BCV47	Phi	N	SOT23	npn darlington
<b>FG</b>	BFQ19S	Sie	P	SOT89	BFR96S
<b>FGAA</b>	MAX6327_R24-T	Max	ZB	SOT23	microproc +ve reset gen 2.400V
<b>FHs</b>	BFN24	Sie	N	SOT23	npn 250V comp to BFN25
<b>FHAA</b>	MAX6327_R25-T	Max	ZB	SOT23	microproc +ve reset gen 2.500V
<b>FIAA</b>	MAX6327_R26-T	Max	ZB	SOT23	microproc +ve reset gen 2.630V
<b>FJ</b>	BFN26	Sie	N	SOT23	npn 300V comp to BFN27
<b>FJAA</b>	MAX6327_R27-T	Max	ZB	SOT23	microproc +ve reset gen 2.700V
<b>FK</b>	BFN25	Sie	N	SOT23	pnp 250V comp to BFN24
<b>FKAA</b>	MAX6327_R28-T	Max	ZB	SOT23	microproc +ve reset gen 2.800V
<b>FL</b>	BFN27	Sie	N	SOT23	pnp 300V comp to BFN26
<b>FLAA</b>	MAX6327_R29-T	Max	ZB	SOT23	microproc +ve reset gen 2.930V
<b>FFMA</b>	MAX6327_R31-T	Max	ZB	SOT23	microproc +ve reset gen 3.080V
<b>FFNA</b>	MAX6327_R30-T	Max	ZB	SOT23	microproc +ve reset gen 3.000V
<b>FOAA</b>	MAX6328_R23-T	Max	ZB	SOT23	microproc -ve reset gen 2.320V
<b>FPAA</b>	MAX6328_R24-T	Max	ZB	SOT23	microproc -ve reset gen 2.400V
<b>F-Q</b>	2PA1576Q	Phi	N	SOT323	gp pnp SC70 hfe 120-270
<b>FtQ</b>	2PA1576Q	Phi	N	SOT323	gp pnp SC70 hfe 120-270
<b>FQAA</b>	MAX6328_R25-T	Max	ZB	SOT23	microproc -ve reset gen 2.500V
<b>FR</b>	2SA1037AK	Roh	N	-	hfe 150@1ma preamp pnp
<b>FR</b>	2SA1576A	Roh	N	UMT	see 2SA1037K above
<b>FR</b>	2SA1774	Roh	N	EM3	see 2SA1037K above
<b>F-R</b>	2PA1576R	Phi	N	SOT323	gp pnp hfe 180-390
<b>FtR</b>	2PA1576R	Phi	N	SOT323	gp pnp hfe 180-390
<b>FRAA</b>	MAX6328_R26-T	Max	ZB	SOT23	microproc -ve reset gen 2.630V
<b>F-S</b>	2PA1576S	Phi	N	SOT323	gp pnp hfe 270-560
<b>FtS</b>	2PA1576S	Phi	N	SOT323	gp pnp hfe 270-560
<b>FSAA</b>	MAX6328_R27-T	Max	ZB	SOT23	microproc -ve reset gen 2.700V
<b>FTAA</b>	MAX6328_R28-T	Max	ZB	SOT23	microproc -ve reset gen 2.800V
<b>FUAA</b>	MAX6328_R29-T	Max	ZB	SOT23	microproc -ve reset gen 2.930V
<b>FVAA</b>	MAX6328_R31-T	Max	ZB	SOT23	microproc -ve reset gen 3.080V
<b>FWAA</b>	MAX6328_R30-T	Max	ZB	SOT23	microproc -ve reset gen 3.000V
<b>FZAP</b>	MAX6012A	Max	ZC	SOT23	precision reference 1.247V
<b>FZAQ</b>	MAX6025A	Max	ZC	SOT23	precision reference 2.500V
<b>FZAR</b>	MAX6041A	Max	ZC	SOT23	precision reference 4.096V
<b>FZAS</b>	MAX6045A	Max	ZC	SOT23	precision reference 4.500V
<b>FZAT</b>	MAX6050A	Max	ZC	SOT23	precision reference 5.000V
<b>FZAU</b>	MAX6021A	Max	ZC	SOT23	precision reference 2.048V
<b>FZAV</b>	MAX6346_R33-T	Max	ZB	SOT23	micrproc -ve reset gen 3.300V
<b>FZAW</b>	MAX6346_R34-T	Max	ZB	SOT23	micrproc -ve reset gen 3.400V
<b>FZAX</b>	MAX6346_R35-T	Max	ZB	SOT23	micrproc -ve reset gen 3.500V
<b>FZAY</b>	MAX6346_R36-T	Max	ZB	SOT23	micrproc -ve reset gen 3.600V
<b>FZAZ</b>	MAX6346_R37-T	Max	ZB	SOT23	micrproc -ve reset gen 3.700V
<b>FZBA</b>	MAX6346_R38-T	Max	ZB	SOT23	micrproc -ve reset gen 3.800V
<b>FZBB</b>	MAX6346_R39-T	Max	ZB	SOT23	micrproc -ve reset gen 3.900V
<b>FZBC</b>	MAX6346_R40-T	Max	ZB	SOT23	micrproc -ve reset gen 4.0800V
<b>FZBD</b>	MAX6346_R41-T	Max	ZB	SOT23	micrproc -ve reset gen 4.100V
<b>FZBE</b>	MAX6346_R42-T	Max	ZB	SOT23	micrproc -ve reset gen 4.200V
<b>FZBF</b>	MAX6346_R43-T	Max	ZB	SOT23	micrproc -ve reset gen 4.300V
<b>FZBG</b>	MAX6346_R44-T	Max	ZB	SOT23	micrproc -ve reset gen 4.380V
<b>FZBH</b>	MAX6346_R45-T	Max	ZB	SOT23	micrproc -ve reset gen 4.500V
<b>FZBI</b>	MAX6346_R46-T	Max	ZB	SOT23	micrproc -ve reset gen 4.630V
<b>FZBJ</b>	MAX6347_R33-T	Max	ZB	SOT23	micrproc +ve reset gen 3.300V
<b>FZBK</b>	MAX6347_R34-T	Max	ZB	SOT23	micrproc +ve reset gen 3.400V
<b>FZBL</b>	MAX6347_R35-T	Max	ZB	SOT23	micrproc +ve reset gen 3.500V
<b>FZBM</b>	MAX6347_R36-T	Max	ZB	SOT23	micrproc +ve reset gen 3.600V
<b>FZBN</b>	MAX6347_R37-T	Max	ZB	SOT23	micrproc +-ve reset gen 3.700V
<b>FZBO</b>	MAX6347_R38-T	Max	ZB	SOT23	micrproc +ve reset gen 3.800V
<b>FZBP</b>	MAX6347_R39-T	Max	ZB	SOT23	micrproc +ve reset gen 3.900V
<b>FZBQ</b>	MAX6347_R40-T	Max	ZB	SOT23	micrproc +ve reset gen 4.0800V
<b>FZBR</b>	MAX6347_R41-T	Max	ZB	SOT23	micrproc +-ve reset gen 4.100V
<b>FZBS</b>	MAX6347_R42-T	Max	ZB	SOT23	micrproc +ve reset gen 4.200V
<b>FZBT</b>	MAX6347_R43-T	Max	ZB	SOT23	micrproc +ve reset gen 4.300V
<b>FZBU</b>	MAX6347_R44-T	Max	ZB	SOT23	micrproc +-ve reset gen 4.380V
<b>FZBV</b>	MAX6347_R45-T	Max	ZB	SOT23	micrproc +ve reset gen 4.500V

<b>FZBW</b>	MAX6347_R46-T	Max	ZB	SOT23	microproc +-ve reset gen 4.630V
<b>FZBX</b>	MAX6348_R33-T	Max	ZB	SOT23	microproc -ve reset gen 3.300V
<b>FZBY</b>	MAX6348_R34-T	Max	ZB	SOT23	microproc -ve reset gen 3.400V
<b>FZBZ</b>	MAX6348_R35-T	Max	ZB	SOT23	microproc -ve reset gen 3.500V
<b>FZCA</b>	MAX6348_R36-T	Max	ZB	SOT23	microproc -ve reset gen 3.600V
<b>FZCB</b>	MAX6348_R37-T	Max	ZB	SOT23	microproc -ve reset gen 3.700V
<b>FZCC</b>	MAX6348_R38T	Max	ZB	SOT23	microproc -ve reset gen 3.800V
<b>FZCD</b>	MAX6348_R39-T	Max	ZB	SOT23	microproc -ve reset gen 3.900V
<b>FZCE</b>	MAX6348_R40-T	Max	ZB	SOT23	microproc -ve reset gen 4.000V
<b>FZCF</b>	MAX6348_R41-T	Max	ZB	SOT23	microproc -ve reset gen 4.100V
<b>FZCG</b>	MAX6348_R42T	Max	ZB	SOT23	microproc -ve reset gen 4.200V
<b>FZCH</b>	MAX6348_R43-T	Max	ZB	SOT23	microproc -ve reset gen 4.380V
<b>FZCI</b>	MAX6348_R44-T	Max	ZB	SOT23	microproc -ve reset gen 4.400V
<b>FZCJ</b>	MAX6348_R45-T	Max	ZB	SOT23	microproc -ve reset gen 4.500V
<b>FZCK</b>	MAX6348_R46-T	Max	ZB	SOT23	microproc -ve reset gen 4.600V
<b>FZCW</b>	MAZ6001UR	Max	ZC	SOT23	1.250V V reference
<b>FZCX</b>	MAZ6002UR	Max	L	SOT23	2.500V V reference
<b>FZCY</b>	MAZ6004UR	Max	L	SOT23	4.096V V reference
<b>FZCZ</b>	MAZ6005UR	Max	L	SOT23	5.000V V reference
<b>FZDA</b>	MAX6012B	Max	ZC	SOT23	precision reference 1.247V
<b>FZDB</b>	MAX6025B	Max	ZC	SOT23	precision reference 2.500V
<b>FZDC</b>	MAX6041B	Max	ZC	SOT23	precision reference 4.096V
<b>FZDD</b>	MAX6045B	Max	ZC	SOT23	precision reference 4.500V
<b>FZdE</b>	MAX6050B	Max	ZC	SOT23	precision reference 5.000V
<b>FZDF</b>	MAX6021B	Max	ZC	SOT23	precision reference 2.047V
<b>FZDK</b>	MAZ6003UR	Max	L	SOT23	3.000V V reference
<b>FZDW</b>	MAX6030A	Max	ZC	SOT23	precision reference 3.000V
<b>FZDX</b>	MAX6012B	Max	ZC	SOT23	precision reference 3.000V
<b>FZEB</b>	LM4041AIM3-1.2	Max	L	SOT23	1.225V 0.1% shunt V ref
<b>FZEC</b>	LM4041BIM3-1.2	Max	L	SOT23	1.225V 0.2% shunt V ref
<b>FZED</b>	LM4041DIM3-1.2	Max	L	SOT23	1.225V 0.5% shunt V ref
<b>FZEE</b>	LM4041DIM3-1.2	Max	L	SOT23	1.225V 1.5% shunt V ref
<b>FZEF</b>	LM4040A IM3-2.1	Max	L	SOT23	2.048V shunt reference 0.1%
<b>FZEG</b>	LM4040B IM3-2.1	Max	L	SOT23	2.048V shunt reference 0.2 %
<b>FZEH</b>	LM4040C IM3-2.1	Max	L	SOT23	2.048V shunt reference 0.5%
<b>FZEI</b>	LM4040D IM3-2.1	Max	L	SOT23	2.048V shunt reference 1.0%
<b>FZEJ</b>	LM4040A IM3-2.5	Max	L	SOT23	2.500V shunt reference 0.1%
<b>FZEK</b>	LM4040B IM3-2.5	Max	L	SOT23	2.500V shunt reference 0.2 %
<b>FZEL</b>	LM4040C IM3-2.5	Max	L	SOT23	2.500V shunt reference 0.5%
<b>FZEM</b>	LM4040D IM3-2.5	Max	L	SOT23	2.500V shunt reference 1.0%
<b>FZEN</b>	LM4040A IM3-3.0	Max	L	SOT23	3.000V shunt reference 0.1%
<b>FZEO</b>	LM4040B IM3-3.0	Max	L	SOT23	3.000V shunt reference 0.2 %
<b>FZEP</b>	LM4040C IM3-3.0	Max	L	SOT23	3.000V shunt reference 0.5%
<b>FZEQ</b>	LM4040D IM3-3.0	Max	L	SOT23	3.000V shunt reference 1.0%
<b>FZER</b>	LM4040A IM3-4.1	Max	L	SOT23	4.096V shunt reference 0.1%
<b>FZES</b>	LM4040B IM3-4.1	Max	L	SOT23	4.096V shunt reference 0.2 %
<b>FZET</b>	LM4040C IM3-4.1	Max	L	SOT23	4.096V shunt reference 0.5%
<b>FZEU</b>	LM4040D IM3-4.1	Max	L	SOT23	4.096V shunt reference 1.0%
<b>FZEV</b>	LM4040A IM3-5.0	Max	L	SOT23	5.000V shunt reference 0.1%
<b>FZEW</b>	LM4040B IM3-5.0	Max	L	SOT23	5.000V shunt reference 0.2 %
<b>FZEX</b>	LM4040C IM3-5.0	Max	L	SOT23	5.000V shunt reference 0.5%
<b>FZEY</b>	LM4040D IM3-5.0	Max	L	SOT23	5.000V shunt reference 1.0%
<b>FZEZ</b>	MAZ803LUR	Max	ZB	SOT23	microproc -ve reset gen, 5.0V
<b>FZFA</b>	MAZ803MUR	Max	ZB	SOT23	microproc -ve reset gen, 5.0V
<b>FZFB</b>	MAZ803TUR	Max	ZB	SOT23	microproc -ve reset gen, 3.3V
<b>FZFC</b>	MAZ803SUR	Max	ZB	SOT23	microproc -ve reset gen, 3.3V
<b>FZFD</b>	MAZ803RUR	Max	ZB	SOT23	microproc -ve reset gen, 3.0V
<b>FZGH</b>	MAZ6006AUR	Max	L	SOT23	1.250V 0.2% shunt V reference
<b>FZGI</b>	MAZ6006BUR	Max	L	SOT23	1.250V 0.5% shunt V reference
<b>FZGJ</b>	MAZ6006CUR	Max	L	SOT23	1.250V 1.0% shunt V reference
<b>FZGK</b>	MAZ6007AUR	Max	L	SOT23	2.480V 0.2% shunt V reference
<b>FZGL</b>	MAZ6007BUR	Max	L	SOT23	2.480V 0.5% shunt V reference
<b>FZGM</b>	MAZ6007CUR	Max	L	SOT23	2.480V 1.0% shunt V reference
<b>FZGN</b>	MAZ6008AUR	Max	L	SOT23	2.500V 0.2% shunt V reference

<b>FZGO</b>	MAZ6008BUR	Max	L	SOT23	2.500V 0.5% shunt V reference
<b>FZGP</b>	MAZ6008CUR	Max	L	SOT23	2.500V 1.0% shunt V reference
<b>FZGQ</b>	MAZ6009AUR	Max	L	SOT23	3.000V 0.2% shunt V reference
<b>FZGR</b>	MAZ6009BUR	Max	L	SOT23	3.000V 0.5% shunt V reference
<b>FZGS</b>	MAZ6009CUR	Max	L	SOT23	3.000V 1.0% shunt V reference

### Codes beginning with 'G'

Code	Device	Manufacturer	Base	Package	Leaded Equivalent/Data
<b>G</b>	BAR63-02W	Sie	I	SCD80	RF pin to 3GHz
<b>G</b>	BAR63-03W	Sie	I	SOD323	RF pin to 3GHz
<b>G</b>	KV1181E	Tok	I	URD	uhf varicap 2-16pF
<b>G</b>	MRF947A	Mot	N	SOT323	npn RF 8GHz
<b>G0</b>	HSMP-3890	HP	C	SOT23	HP3890 pin sw diode
<b>G0</b>	HSMP-389B	HP	C	SOT323	HP3890 pin sw diode
<b>G08</b>	DTD133HKA	Roh	N	SC59	npn dtr 3k3+10k 50V 500mA
<b>G1</b>	BFS20	Phi	N	SOT23	BF199
<b>G1p</b>	BFS20	Phi	N	SOT23	BF199
<b>G1</b>	BFS20	Phi	N	SOT23	BF199
<b>G1t</b>	HSMP-3891	HP	K	SOT23	HP3890 pin sw diode
<b>G1</b>	MMBT5551	Mot	N	SOT23	2N5551 npn Vce 140V
<b>tG1</b>	PMBT5551	Phi	N	SOT23	2N5551 npn Vce 140V
<b>tG1</b>	PMST5551	Phi	N	SOT323	2N5551 npn Vce 140V
<b>G1E</b>	BC847A	Rho	N	SOT23	BC547A
<b>G1F</b>	BC847B	Rho	N	SOT23	BC547B
<b>G1G</b>	BC847C	Rho	N	SOT23	BC547C
<b>G1J</b>	BC848A	Rho	N	SOT23	BC548A
<b>G1K</b>	BC848B	Rho	N	SC70	BC548B
<b>G1K</b>	BC848B	Rho	N	SOT23	BC548B
<b>G1L</b>	BC848C	Rho	N	SOT23	BC548C
<b>G2</b>	HSMP-3892	HP	D	SOT23	dual ser HP3890 pin sw diode
<b>G2</b>	CGY50	Sie	IQ	SOT143	GaAs MMIC amp
<b>G3</b>	HSMP-3893	HP	A	SOT23	dual HP3890 pin sw diode
<b>pG3</b>	PMST5551	Phi	N	SOT323	2N5551
<b>G3</b>	BAR63	Sie	C	SOT23	single 3GHz pin
<b>G3C</b>	DTB122JK	Roh	N	SC59	pnp dtr 220R + 470R 50V 500mA
<b>G3E</b>	BC857A	Roh	N	SOT23	BC557A
<b>G3F</b>	BC857B	Roh	N	SOT23	BC557B
<b>G3J</b>	BC858A	Roh	N	SOT23	BC558A
<b>G3K</b>	BC858B	Roh	N	SOT23	BC558B
<b>G3K</b>	BC858B	Roh	N	SC70	BC558B
<b>G3L</b>	BC858C	Roh	N	SOT23	BC558C
<b>G4</b>	BFS20R	Phi	N	SOT23	BF199
<b>G4</b>	HSMP-3894	HP	B	SOT23	dual HP3890 pin sw diode
<b>G4</b>	BAR63-04	Sie	D	SOT23	dual series 3GHz pin
<b>G4C</b>	DTD122JK	Roh	N	SC59	npn dtr 220R + 470R 50V 500mA
<b>G4s</b>	BAR63-04W	Sie	D	SOT323	dual series 3GHz pin
<b>G5</b>	HSMP-3895	HP	S	SOT143	dual HP3890 pin sw diode
<b>G5</b>	BAR63-05	Sie	B	SOT23	dual cc 3GHz pin
<b>G5s</b>	BAR63-05W	Sie	B	SOT323	dual cc 3GHz pin
<b>G5B</b>	BC807-25	Roh	N	SOT23	BC327-25
<b>G6</b>	BAR63-06	Sie	A	SOT23	dual ca 3GHz pin
<b>G6s</b>	BAR63-06W	Sie	A	SOT323	dual ca 3GHz pin
<b>G6A</b>	BC817-16	Roh	N	-	BC337-16
<b>G6B</b>	BC817-25	Roh	N	SOT23	BC337-25
<b>G7</b>	BF579	Tfk	N	-	BF979 pnp uhf ft 1.75GHz
<b>G11</b>	DTB113ZKA	Roh	N	SC59	pnp dtr 1k0 + 10k 50V 500mA
<b>G21</b>	DTD113ZKA	Roh	N	SC59	npn dtr 1k0 + 10k 50V 500mA
<b>G98</b>	DTB133HKA	Roh	N	SC59	pnp dtr 3k3+10k 50V 500mA
<b>GA</b>	HSMP-4890	HP	B	SOT23	0.5-3GHz dual cc pin limiter
<b>GA</b>	BAW78A	Sie	LQ	SOT89	50V1A sw diode
<b>GAB</b>	BCW60B	Rho	N	SOT23	BCY58-viii
<b>GAC</b>	BCW60C	Rho	N	SOT23	BCY58-ix
<b>GAD</b>	BCW60D	Rho	N	SOT23	BCY58-x

<b>GAH</b>	BCX70H	Rho	N	SOT23	BCY59-viii BC107B
<b>GAJ</b>	BCX70J	Rho	N	SOT23	BCY59-ix BC107
<b>GAK</b>	BCX70K	Rho	N	SOT23	BCY59-x BC107
<b>GB</b>	BAW78B	Sie	LQ	SOT89	100V 1A sw diode
<b>GBB</b>	BCW61B	Rho	N	SOT23	BCY78-viii
<b>GBC</b>	BCW61C	Rho	N	SOT23	BCY78-ix
<b>GBG</b>	BCX71G	Rho	N	SOT23	BCY79-vii
<b>GBH</b>	BCX71H	Rho	N	SOT23	BCY79-viii
<b>GBJ</b>	BCX71J	Rho	N	SOT23	BCY79-ix
<b>GC</b>	BAW78C	Sie	LQ	SOT89	200V 1A sw diode
<b>GC1</b>	BCW29	Roh	N	SOT23	BC178A
<b>GC2</b>	BCW30	Roh	N	SOT23	BC178B
<b>GD</b>	BAW78D	Sie	LQ	SOT89	400V 1A sw diode
<b>GD1</b>	BCW31	Roh	N	SOT23	BC108C
<b>GD2</b>	BCW32	Roh	N	SOT23	BC108B
<b>GD3</b>	BCW33	Roh	N	SOT23	BC108A
<b>GE</b>	BFR35AP	Sie	N	SOT23	BFR34A
<b>GE</b>	BAW79A	Sie	JQ	SOT89	dual cc 50V 1A switch diodes
<b>GEC</b>	BCW65C	Rho	N	SOT23	npn 32V 800mA hfe 250 min
<b>GF</b>	BFR92P	Sie	N	SOT23	BFR90
<b>GF</b>	BAW79B	Sie	JQ	SOT89	dual cc 100V 1A switch diodes
<b>GG</b>	BF579R	Tfk	R	-	BF979 npn uhf fT1.75GHz
<b>GG</b>	BFR93P	Sie	N	SOT23	BFR91A
<b>GG</b>	BAW79C	Sie	JQ	SOT89	dual cc 200V 1A switch diodes
<b>GH</b>	BAW79D	Sie	JQ	SOT89	dual cc 400V 1A switch diodes
<b>GH1</b>	BCW69	Roh	N	SOT23	BC177A
<b>GH2</b>	BCW70	Roh	N	SOT23	BC177B
<b>GK1</b>	BCW71	Roh	N	SOT23	BC107A
<b>GK2</b>	BCW72	Roh	N	SOT23	BC107B ZXT300
<b>GLP</b>	MMBT1010	Mot	N	SOT23	nnp 15V hfe 300-600 @100mA
<b>GLP</b>	MMBT1010	Mot	N	SOT346	nnp 15V hfe 300-600 @100mA
<b>GMA</b>	BFS17	Roh	N	SOT23	BFW92
<b>GT1</b>	BCX17	Roh	N	SOT23	BC327
<b>GT2</b>	BCX18	Roh	N	SOT23	BC328
<b>GU1</b>	BCX19	Roh	N	SOT23	BC337
<b>GU2</b>	BCX20	Roh	N	SOT23	BC338

### Codes beginning with 'H'

Code	Device	Manufacturer	Base	Package	Leaded Equivalent/Data
<b>H</b>	MRF947B	Mot	N	SOT323	nnp RF 8GHz
<b>H</b>	BB659C	Sie	I	SCD80	2.5-39 pF varicap in
<b>H</b>	BBY51-03W	Sie	I	SOD323	3-5 pF varicap in
<b>H02</b>	DTC323TU	Rho	N	SC70	nnp dtr 15V 0.6A, R1 2k $\Omega$ , for muting
<b>H04</b>	DTC323TU	Rho	N	SC70	nnp dtr 15V 0.6A, R1 10k $\Omega$ , for muting
<b>H1</b>	BCW69	Phi	N	SOT23	BC177A
<b>H1p</b>	BCW69	Phi	N	SOT23	BC177A
<b>H1t</b>	BCW69	Phi	N	SOT23	BC177A
<b>H2</b>	BCW70	Phi	N	SOT23	BC177B
<b>H2p</b>	BCW70	Phi	N	SOT23	BC177B
<b>H2t</b>	BCW70	Phi	N	SOT23	BC177B
<b>H3</b>	BCW89	Phi	N	SOT23	BC556
<b>H3p</b>	BCW89	Phi	N	SOT23	BC556
<b>H3t</b>	BCW89	Phi	N	SOT23	BC556
<b>H4</b>	BCW69R	Phi	R	SOT23R	BC177A
<b>H5</b>	BCW70R	Phi	R	SOT23R	BC177B
<b>H5</b>	MBD770DW	Mot	DL	-	Dual UHF schottky diode
<b>H6</b>	BCW89R	Phi	R	SOT23R	BC556
<b>H11</b>	UMH11TN	Roh	DI	-	nnp/pnpdtr pair 10k+10k
<b>H16</b>	SST4416	Sil	F	-	2N4416 n-ch jfet
<b>H27</b>	DTC323TU	Rho	N	SC70	nnp dtr 15V 0.6A, R1 6k $\Omega$ , for muting
<b>H31</b>	BCW89R	Phi	N	SOT23R	BC556
<b>H84</b>	SST5484	Sil	F	SOT23	2N5484
<b>H85</b>	SST5485	Sil	F	SOT23	2N5485

<b>H86</b>	SST5486	Sil	F	SOT23	2N5486
<b>HB</b>	BFN22	SGS	P	SOT23	npn Vce 250V
<b>HC</b>	BFN23	SGS	P	SOT23	npn Vce 250V
<b>HG</b>	CFY77-08	Sie	DM	-	20GHz HEMT 0.8dB nf
<b>HH</b>	CFY77-10	Sie	DM	-	20GHz HEMT 1.0 dB nf
<b>HH</b>	BBY51-07	Sie	S	SOT143	dual varicap like BBY51
<b>HQ</b>	2SA1036K	Roh	N	-	pnnp 500mA driver

### Codes beginning with 'I'

Code	Device	Manufacturer	Base	Package	Leaded Equivalent/Data
<b>I</b>	BBY51-02W	Sie	I	SCD80	3-5 pF varicap
<b>I</b>	BBY52-03W	Sie	I	SOD323	1.25-1.75 pF varicap in
<b>I08</b>	SST108	Sil	F	SOT23	J108 n-ch jfet
<b>I09</b>	SST109	Sil	F	SOT23	J109 n-ch jfet
<b>I10</b>	SST110	Sil	F	SOT23	J110 n-ch jfet

### Codes beginning with 'J'

Code	Device	Manufacturer	Base	Package	Leaded Equivalent/Data
<b>J0</b>	HSMS-2840	HP	C	SOT23	schottky diode
<b>J01</b>	SO2906R	-	N	-	2N2906
<b>J03</b>	SO2907AR	-	R	-	2N2907A
<b>J05</b>	SO2907R	-	R	-	2N2907
<b>J1</b>	HSMS-2841	HP	K	SOT23	schottky diode
<b>J1</b>	ZC830	Zet	C	-	ZC820 varicaps
<b>J1</b>	BSS138L	Mot	M	SOT23	n-ch enh TMOS fet
<b>J1A</b>	ZC830A	Zet	C	SOT23	varicap hyperabrupt 28V 10pF@2V
<b>J1B</b>	ZC830B	Zet	C	SOT23	varicap hyperabrupt 28V 10pF@2V
<b>pJ1</b>	BSH101	Phi	M	SOT23	n-ch 60V 0.7A mosfet
<b>pJ2</b>	BSH102	Phi	M	SOT23	n-ch 30V 1A mosfet
<b>J2</b>	ZC833	Zet	C	SOT23	ZC823
<b>J2A</b>	ZC833A	Zet	C	SOT23	varicap hyperabrupt 28V 33pF@2V
<b>J2B</b>	ZC833B	Zet	C	SOT23	varicap hyperabrupt 28V 33pF@2V
<b>pJ3</b>	BSH103	Phi	M	SOT23	n-ch 30V 0.8A mosfet
<b>J3</b>	ZC831	Zet	C	SOT23	ZC821
<b>J3A</b>	ZC831A	Zet	C	SOT23	varicap hyperabrupt 28V 15pF@2V
<b>J3B</b>	ZC831B	Zet	C	SOT23	varicap hyperabrupt 28V 15pF@2V
<b>J3D</b>	MSB81T1	Mot	-	-	vhf pnp fT 0.6GHz
<b>J4A</b>	MBV109	Mot	C	SOT23	29pF VHF varicap diode
<b>J4</b>	ZC832	Zet	C	SOT23	ZC823
<b>J4A</b>	ZC832A	Zet	C	SOT23	varicap hyperabrupt 28V 22pF@2V
<b>J4B</b>	ZC832B	Zet	C	SOT23	varicap hyperabrupt 28V 22pF@2V
<b>J5</b>	ZC834	Zet	C	SOT23	ZC824
<b>J5A</b>	ZC834A	Zet	C	SOT23	varicap hyperabrupt 28V 47pF@2V
<b>J5B</b>	ZC834B	Zet	C	SOT23	varicap hyperabrupt 28V 47pF@2V
<b>J6</b>	M1MA174	Mot	C	-	gp Si diode 100V
<b>J6</b>	ZC835	Zet	C	SOT23	ZC825
<b>J6A</b>	ZC835A	Zet	C	SOT23	varicap hyperabrupt 28V 68pF@2V
<b>J6B</b>	ZC835B	Zet	C	SOT23	varicap hyperabrupt 28V 68pF@2V
<b>J7</b>	ZC836	Zet	C	SOT23	ZC826
<b>J7A</b>	ZC830A	Zet	C	SOT23	varicap hyperabrupt 28V 100pF@2V
<b>J7B</b>	ZC830B	Zet	C	SOT23	varicap hyperabrupt 28V 100pF@2V
<b>J8</b>	BCX71JR	Phi	R	SOT23R	BCY79-ix
<b>J9A</b>	ZC829A	Zet	I	SOT23	varicap hyperabrupt 28V 8.2pF@2V
<b>J9B</b>	ZC829B	Zet	I	SOT23	varicap hyperabrupt 28V 8.2pF@2V
<b>J12</b>	SO2906AR	-	R	-	2N2906A
<b>J32</b>	SO5400R	SGS	R	-	2N5400
<b>J33</b>	SO5401R	SGS	R	-	2N5401
<b>J39</b>	SO692R	SGS	-	-	pnnp Vce 300V
<b>JA</b>	BAV74	Zet	B	SOT23	dual diode cc 50V 0.1A
<b>JA</b>	BAV74	Mot	B	SOT23	dual sw diodes
<b>JBs</b>	BAR74	Sie	C	SOT23	fast sw diode 50V 0.25A

<b>JCs</b>	BAL74	Sie	V	SOT23	fast sw diode 50V 0.25A
<b>JFs</b>	BAL99	Sie	V	SOT23	fast sw diode 70V 0.25A
<b>JG</b>	BAR99	Sie	E	-	fast sw diode 70V 0.25A
<b>JKs</b>	BF1009	Sie	W	SOT143	biased n-ch dg mosfet 1GHz 9V
<b>JLs</b>	BF1009S	Sie	W	SOT143	biased n-ch dg mosfet 1GHz 9V
<b>JL</b>	MRF949	Mot	N	SOT323	npn RF fT 9GHz
<b>JP</b> s	BAS19	Sie	C	SOT23	120V 250mA fast sw diode
<b>JP</b> s	BAW101	Sie	S	SOT143	pair isolated 300V sw diodes
<b>JRs</b>	BAS20	Sie	C	SOT23	150V 250mA fast sw diode
<b>JS</b> s	BAS21	Sie	C	SOT143	200V 250mA fast sw diode
<b>JS</b>	BAW100	Sie	Y	SOT143	dual isolated fast sw diodes
<b>JTs</b>	BAS28	Sie	S	SOT143	dual isolated fast sw diodes
<b>JTs</b>	BAS28W	Sie	FQ	SOT343	dual isolated fast sw diodes
<b>JV</b>	BAS116	Sie	C	SOT23	250V 75mA Ir 5nA
<b>JX</b>	BAV170	Mot	B	SOT23	dual cc Si diode low Ir
<b>JY</b>	BAV199	Mot	D	SOT23	dual series Si diode low Ir
<b>JZ</b>	BAW156	Mot	A	SOT23	dual ca Si diode low Ir

### Codes beginning with 'K'

Code	Device	Manufacturer	Base	Package	Leaded Equivalent/Data
<b>K</b>	BAT68-03W	Sie	I	SOD323	BAT68 Schottky
<b>K</b>	BBY52-02W	Sie	I	SCD80	UHF varicap 1.75-1.25pF
<b>K</b>	MRF917	Mot	N	SOT323	npn RF fT 6GHz
<b>K0</b>	HSMP-3830	HP	C	SOT23	gp pin diode HP3830
<b>K1</b>	HSMP-3831	HP	K	SOT23	gp pin diode HP3830
<b>K1p</b>	BCW71	Phi	N	SOT23	BC107A
<b>K1t</b>	BCW71	Phi	N	SOT23	BC107A
<b>K1</b>	BCW71	Phi	N	SOT23	BC107A
<b>K2p</b>	BCW72	Phi	N	SOT23	BC107B ZXT300
<b>K2t</b>	BCW72	Phi	N	SOT23	BC107B ZXT300
<b>K2</b>	BCW72	Phi	N	SOT23	BC107B ZXT300
<b>K2</b>	HSMP-3832	HP	D	SOT23	dual HP3830 pin diode
<b>K3</b>	HSMP-3833	HP	A	SOT23	dual HP3830 pin diode
<b>K3</b>	BCW81	Phi	N	SOT23	npn 50V 0.1A 0.2W hfe 420
<b>K3p</b>	BCW81	Phi	N	SOT23	npn 50V 0.1A 0.2W hfe 420
<b>K3t</b>	BCW81	Phi	N	SOT23	npn 50V 0.1A 0.2W hfe 420
<b>K4</b>	BCW71R	Phi	R	SOT23R	BC107A
<b>K4</b>	HSMP-3834	HP	B	SOT23	dual HP3830 pin diode
<b>K5</b>	BCW72R	Phi	R	SOT23R	BC107B ZTX300
<b>K6</b>	BCV71R	Phi	R	SOT23R	BC546A
<b>K7</b>	BCV71	Phi	N	SOT23	BC546A
<b>K7p</b>	BCV71	Phi	N	SOT23	BC546A
<b>K7t</b>	BCV71	Phi	N	SOT23	BC546A
<b>K8</b>	BCV72	Phi	N	SOT23	BC546B
<b>K8p</b>	BCV72	Phi	N	SOT23	BC546B
<b>K8t</b>	BCV72	Phi	N	SOT23	BC546B
<b>K9</b>	BCV72R	Phi	R	SOT23R	BC546B
<b>K14</b>	DTA114GE	Roh	N	EMT3	pnp dtr 50V 100mA R2 10k
<b>K14</b>	DTA114GUA	Roh	N	SC70	pnp dtr 50V 100mA R2 10k
<b>K14</b>	DTA114GKA	Roh	N	SC59	pnp dtr 50V 100mA R2 10k
<b>K15</b>	DTA124GKA	Roh	N	SC59	pnp dtr 50V 50mA R2 22k
<b>K16</b>	DTA144GUA	Roh	N	SC70	npn dtr 50V 100mA R2 47k
<b>K16</b>	DTA144GKA	Roh	N	SC59	npn dtr 50V 100mA R2 47k
<b>K19</b>	DTA115GUA	Roh	N	SC70	npn dtr 50V 100mA R2 100k
<b>K19</b>	DTA115GKA	Roh	N	SC59	npn dtr 50V 100mA R2 100k
<b>K24</b>	DTC114GUA	Roh	N	SC70	npn dtr 50V 100mA R2 22k
<b>K24</b>	DTC114GKA	Roh	N	SC59	npn dtr 50V 100mA R2 22k
<b>K25</b>	DTA124GUA	Roh	N	SC70	pnp dtr 50V 50mA R2 22k
<b>K25</b>	DTA124GKA	Roh	N	SC59	pnp dtr 50V 50mA R2 22k
<b>K26</b>	DTC144GE	Roh	N	EMT3	npn dtr 50V 100mA R2 47k
<b>K26</b>	DTC144GUA	Roh	N	SC70	npn dtr 50V 100mA R2 47k
<b>K26</b>	DTC144GKA	Roh	N	SC59	npn dtr 50V 100mA R2 47k
<b>K29</b>	DTC115GUA	Roh	N	SC70	npn dtr 50V 100mA R2 100k

<b>K29</b>	DTC115GKA	Roh	N	SC59	npn dtr 50V 100mA R2 100k
<b>K31</b>	BCW81R	Phi	R	-	npn 50V 0.1A 0.2W hfe 420
<b>KB</b>	MMBT8099L	Mot	N	SOT23	npn 80V gp
<b>KC</b>	BFQ29P	Sie	N	-	BFT66
<b>KM</b>	BST80	Phi	T	-	VN10
<b>KN</b>	BST84	Phi	T	-	Nch VMOS 200V 0.25A
<b>KO</b>	BST86	Phi	T	-	nch VMOS 180V 0.3A

### Codes beginning with 'L'

<b>Code</b>	<b>Device</b>	<b>Manufacturer</b>	<b>Base</b>	<b>Package</b>	<b>Leaded Equivalent/Data</b>
<b>L</b>	BAT62-03W	Sie	I	SOD323	BAT62 schottky detector
<b>L</b>	BBY53-02W	Sie	I	SCD80	varicap 5.3-2.2 pF
<b>L0</b>	HSMP-386B	HP	C	SOT323	gp RF pin diode
<b>L0</b>	HSMP-3860	HP	C	SOT23	dual series pin diode
<b>L0</b>	BAT721S	Phi	C	SOT23	dual series 40V 200mA schottky
<b>L05</b>	ZLLS500	Zet	C	SOT23	schottky 40V 0.7A low leakage high temp
<b>L1</b>	BSS65	Zet	N	-	npn 12V 0.1A 400MHz sw
<b>L10</b>	ZLLS1000	Zet	C	SOT23	schottky 40V 1.1A low leakage high temp
<b>L2</b>	HSMP-3862	HP	D	SOT23	dual RF pin diode
<b>L2</b>	BSS69	Zet	N	-	npn 40V 0.1A 200MHz sw
<b>L3</b>	BSS70	Zet	N	-	npn 40V 0.1A 200MHz sw
<b>L3</b>	MMBC1623L3	Mot	N	-	npn 40V gp
<b>L3</b>	HSMP-3863	HP	A	SOT23	ca gp RF pin diode
<b>L4</b>	HSMP-3864	HP	B	SOT23	cc gp RF pin diode
<b>L4</b>	BAT54W	Phi	C	SOT323	BAT85 schottky
<b>L4p</b>	BAT54	Phi	C	SOT23	BAT85 schottky
<b>L4Z</b>	BAT54	Zet	C	SOT23	BAT85 schottky
<b>L4</b>	MMBC1623L4	Mot	N	-	npn 40V gp
<b>L5</b>	BSS65R	Zet	R	-	npn 12V 0.1A 400MHz sw
<b>L5</b>	MMBC1623L5	Mot	N	-	MPS3904 hfe 135-270
<b>L6</b>	BAR17	Sie	C	-	pin diode
<b>L6</b>	BSS69R	Zet	N	-	npn 40V 0.1A 200MHz sw
<b>L6</b>	MMBC1623L6	Mot	N	-	MPS3904 hfe 200-400
<b>L7</b>	BSS70R	Zet	N	-	npn 40V 0.1A 200MHz sw
<b>L7</b>	MMBC1623L7	Mot	N	-	MPS3904 hfe 300-600
<b>L7</b>	BAR14-1	Sie	D	-	dual pin 100mA max
<b>L8</b>	BAT721A	Phi	A	SOT23	dual c anode 40V 200mA schottky
<b>L8</b>	BAR15-1	Sie	A	-	dual pin 100mA max
<b>L9</b>	BAT721C	Phi	B	SOT23	dual c cathode 40V 200mA schottky
<b>L9</b>	BAR16-1	Sie	B	-	dual pin 100mA max
<b>L14</b>	DTB114GK	Rho	N	SC59	npn dtr 0.5A, R2 10k
<b>L20</b>	BAS29	Nat	C	SOT23	Si diode 120V 50mA
<b>L21</b>	BAS31	Nat	D	SOT23	dual BAS29 diodes
<b>L22</b>	BAS35	Nat	A	SOT23	dual BAS29 diodes
<b>L14</b>	DTD114GK	Rho	N	SC59	npn dtr 0.5A, R2 10k
<b>L30</b>	BAV23	Phi	S	SOT143	dual 200V 225mA diodes
<b>L41</b>	BAT74	Phi	S	SOT143	2x BAT85
<b>L42p</b>	BAT54A	Phi	A	SOT23	dual c anode schottky
<b>L43p</b>	BAT54C	Phi	B	SOT23	dual c cathode schottky
<b>L44p</b>	BAT54S	Phi	D	SOT23	dual series schottky
<b>L51</b>	BAS56	Phi	S	SOT143	dual 60V 200mA diodes
<b>LAp</b>	BF550	Phi	N	SOT23	npn 40V 25mA
<b>LB</b>	S525T	Tfk	G	-	n-ch vhf mosfet 200MHz
<b>LBs</b>	BF999	Sie	G	SOT23	n-ch vhf mosfet 300MHz
<b>LDs</b>	BF543	Sie	G	SOT23	n-ch vhf mosfet 300MHz
<b>LEs</b>	BF660	Sie	N	SOT23	BF606A npn vhf osc fT 800MHz
<b>LGs</b>	BF775A	Sie	N	SOT23	npn RF fT 5.6GHz for IF amp
<b>LHs</b>	BF569	Sie	N	SOT23	BF970 npn RF
<b>LKs</b>	BF799	Sie	N	SOT23	BF959
<b>LKs</b>	BF799W	Sie	N	SOT323	BF959
<b>LH</b>	BF569R	Tfk	R	-	BF970 npn RF
<b>LM</b>	BST120	Phi	T	-	p-ch DMOSfet 60V 0.3A
<b>LN</b>	BST122	Phi	T	-	p-ch DMOSfet 50V 0.25A



<b>LKs</b>	BF799	Sie	N	SOT23	BF959
<b>LKs</b>	BF799W	Sie	N	SOT323	BF959
<b>LOs</b>	BF775	Sie	N	SOT23	BFQ69
<b>LOs</b>	BF775W	Sie	N	SOT323	BFQ69
<b>LRs</b>	BF517	Sie	T	SOT23	BF763 2.5 GHz
<b>LSs</b>	BF770A	Sie	N	SOT23	npn low noise RF, Ft 6GHz

### Codes beginning with 'M'

Code	Device	Manufacturer	Base	Package	Leaded Equivalent/Data
<b>M (blue)</b>	BAR65-03W	Sie	I	SOD323	pin diode
<b>M (white)</b>	BBY55-03W	Sie	I	SOD323	5.4-2.3pF varicap in
<b>M</b>	BAR64-02W	Sie	I	SCD80	pin diode
<b>M</b>	BAR65-07	Sie	S	SOT143	dual pin diode
<b>M08</b>	PMBFJ308	Phi	F	SOT23	VHF n-ch JFET J308
<b>M09</b>	PMBFJ309	Phi	F	SOT23	VHF n-ch JFET J309
<b>M10</b>	PMBFJ310	Phi	F	SOT23	VHF n-ch JFET J310
<b>M1</b>	BFR30	Phi	F	SOT23	BFW11 BF245
<b>M1B</b>	MMBT2222L	Mot	N	SOT23	2N2222
<b>M1E</b>	MMBTA43L	Mot	N	SOT23	MPSA43 200V Vce npn
<b>M1F</b>	MMBT5550L	Mot	N	SOT23	2N5550 npn 140V
<b>M1J</b>	MMBT2369L	Mot	N	SOT23	2N2369A
<b>M2</b>	BFR31	Phi	F	SOT23	BFW12 BF245
<b>M2B</b>	MMBT2907L	Mot	N	SOT23	2N2907 pnp gp
<b>M2C</b>	MMBTA70L	Mot	N	SOT23	gp pnp MPSA70
<b>M3</b>	BFT46	Phi	F	SOT23	n-ch fet gp low level amp
<b>M3</b>	MMBA812M3	Mot	N	-	2N5086 hfe 60-120 pnp
<b>M3A</b>	MMBTH24L	Mot	N	SOT23	npn VHF amp 400MHz fT 30V
<b>M3B</b>	MMBT918L	Mot	N	SOT23	2N918 UHF amp
<b>M3J</b>	MMBTH69L	Mot	N	SOT23	pnp VHF amp 2GHz fT 15V
<b>M4</b>	BSR56	Phi	F	-	2N4856 n-ch fet
<b>M4</b>	MBD110DW	Mot	DL	SOT363	dual UHF schottky
<b>M4A</b>	MMBV109	Mot	C	SOT323	Hyperabrupt varicap
<b>M4B</b>	MMBV432	Mot	B	SOT23	dual cc varicap 45pF/2V
<b>M4C</b>	MMBV3102	Mot	C	SOT23	Hyperabrupt varicap
<b>M4E</b>	MMBV105G	Mot	C	SOT23	Hyperabrupt varicap
<b>M4F</b>	MMBD353	Mot	D	SOT23	dual MBD101 in series
<b>M4G</b>	MMBV2101	Mot	C	SOT23	varicap 6.8pF MV2101
<b>M5</b>	BSR57	Phi	F	-	2N5457 n-ch fet
<b>M5</b>	MMBA812M5	Mot	N	-	2N5086 hfe 135-270 pnp
<b>M5C</b>	MMBD7000	Mot	D	SOT23	100V 2x series sw diodes
<b>M5</b>	MMBD352W	Mot	Z	SOT323	2x MBD101 in series
<b>M6</b>	BSR58	Phi	F	SOT23	2N4858 n-ch fet
<b>M6</b>	MMBA812M6	Mot	N	-	2N5086 hfe 200-400 pnp
<b>M6</b>	BSS66	Zet	N	-	npn 40V 0.1A sw fT 250MHz
<b>M6A</b>	MMBF4416	Mot	F	SOT23	2N4416 n-ch rf jfet
<b>M6B</b>	MMBF5484	Mot	F	SOT23	2N5484 n-ch rf jfet
<b>M6C</b>	MMBFU310	Mot	F	SOT23	U310 n-ch rf jfet
<b>M6E</b>	MMBF5460	Mot	F	SOT23	2N5460 n-ch rf jfet
<b>M6H</b>	MMBD354	Mot	A	SOT23	dual MBD101 cc
<b>M7</b>	BSS67	Zet	N	-	npn 40V 0.1A sw fT 300MHz
<b>M7</b>	MMBA812M7	Mot	N	-	2N5086 hfe 300-600 pnp
<b>M8</b>	BSS66R	Zet	R	-	npn 40V 0.1A sw fT 250MHz
<b>M8</b>	BSH103	Phi	M	SOT23	n-ch 50V 0.11A mosfet
<b>M8p</b>	BSN20	Phi	M	SOT23	n-ch 50V 0.11A mosfet
<b>M9</b>	BSS67R	Zet	R	-	npn 40V 0.1A sw fT 300MHz
<b>M10</b>	PMBFJ310	Phi	F	SOT23	J310 n-ch jfet
<b>M31</b>	BSD20	Phi	XQ	-	n-ch depl sw mosfet 10V
<b>M32</b>	BSD22	Phi	XQ	-	n-ch depl sw mosfet 20V
<b>M56</b>	BF1100	Phi	W	SOT143	dg mosfet 14V 30mA 0.2W
<b>M57</b>	BF1100R	Phi	UQ	SOT143R	dg mosfet 14V 30mA 0.2W
<b>M74</b>	BSS83	Phi	XQ	-	n-ch enh sw mosfet
<b>M89</b>	BF989	Phi	K	-	BF960
<b>M90</b>	BF990	Phi	W	-	BF980

<b>M91</b>	BF991	Phi	W	-	BF981
<b>M92</b>	BF992	Phi	W	-	BF982
<b>M94</b>	BF994	Phi	W	-	BF964
<b>M96</b>	BF996	Phi	W	-	BF966
<b>M97</b>	BFR101A	-	-	-	-
<b>M98</b>	BFR101B	-	-	-	-
<b>MA</b>	M1MA151AT	Mot	E	SOT346	40V 100mA sw diode
<b>MA</b>	MBT3904DW1	Mot	DN	SOT363	dual 2N3904
<b>MA</b>	M1MA152AT	Mot	E	SOT346	80V 100mA sw diode
<b>MA</b>	BFS17	-	N	SOT23	BFW92
<b>MB</b>	BF995	Sie	W	-	n-ch vhf dg mosfet BF961
<b>MB</b>	MBT3904DW9	Mot	-	-	dual 2N3904
<b>MCs</b>	BFS17P	Sie	N	SOT23	BFW92
<b>MCs</b>	BFS17PW	Sie	N	SOT323	BFW92
<b>MC</b>	ZVN3306F	Zet	M	SOT23	n-ch mosfet 60V 150mA
<b>MF</b>	ZVN3310F	Zet	M	SOT23	n-ch mosfet 100V 100mA
<b>MG</b>	BF994S	Tfk	W	-	BF964 n-ch dg vhf mosfet
<b>MH</b>	BF996S	Tfk	W	-	BF966 n-ch dg vhf mosfet
<b>MH</b>	M1MA141KT	Mot	C	SOT323	40V 100mA sw diode
<b>MH</b>	M1MA151KT	Mot	C	SOT346	40V 100mA sw diode
<b>MI</b>	M1MA142KT	Mot	C	SOT323	80V 100mA sw diode
<b>MI</b>	M1MA152KT	Mot	C	SOT346	80V 100mA sw diode
<b>ML</b>	ZVP3306F	Zet	M	SOT23	p-ch mosfet 60V 90mA
<b>MN</b>	M1MA141WA	Mot	A	SOT323	d diode ca 40V 100mA
<b>MN</b>	M1MA151WA	Mot	A	SOT346	d diode ca 40V 100mA
<b>MO</b>	M1MA142W	Mot	A	SOT323	d diode ca 80V 100mA
<b>MO</b>	M1MA152W	Mot	A	SOT346	d diode ca 80V 100mA
<b>MOs</b>	BF998	Sie	W	SOT143	n-ch vhf dg mosfet BF988
<b>MOR</b>	BF998R	Tfk	UQ	SOT143R	n-ch vhf dg mosfet BF988
<b>MR</b>	BF998W	Sie	UQ	SOT343	n-ch vhf dg mosfet BF988
<b>MR</b>	ZVP3310F	Zet	M	SOT23	p-ch mosfet 100V 75mA
<b>MS</b>	CF739	Sie	W	-	dg GaAsfet 2GHz
<b>MT</b>	M1MA141WK	Mot	B	SOT323	dual diode cc 40V 100mA
<b>MT</b>	M1MA151WK	Mot	B	SOT346	dual diode cc 40V 100mA
<b>MU</b>	M1MA142WK	Mot	B	SOT323	dual diode cc 80V 100mA
<b>MU</b>	M1MA152WK	Mot	B	SOT346	dual diode cc 80V 100mA
<b>MU</b>	ZVN3320F	Zet	M	SOT23	n-ch mosfet 200V 60mA
<b>MX</b>	CF750	Sie	U	-	biased dg GaAsfet, 3-6V
<b>MY</b>	VN10LF	Zet	M	SOT23	n-ch mosfet 60V 150mA
<b>MY</b>	BF1012	Sie	W	-	n-ch dg mosfet 1GHz 12V
<b>MZ</b>	ZVN4106F	Zet	M	SOT23	n-ch mosfet 60V 200mA
<b>MZ</b>	BF1005	Sie	W	-	n-ch dg mosfet 1GHz 5V

### Codes beginning with 'N'

Code	Device	Manufacturer	Base	Package	Leaded Equivalent/Data
<b>N</b>	DAN202K	Roh	B	-	80V 100mA dual diode
<b>N0</b>	TN0200T	Nat	M	SOT23	n-ch mosfet 0.6A Id
<b>N1</b>	MMBT100	Nat	N	-	npn gp sw 500mA
<b>N1</b>	MMBF201N	Mot	M	SOT23	n-ch tmosfet 20V 0.3A Id
<b>N1</b>	MRF571	Mot	N	SOT416	8 GHz 40mA npn RF
<b>N1</b>	TN0201T	Tem	M	SOT23	n-ch mosfet 0.3A Id 0.2W
<b>N2</b>	MGSF1N02LT1	Mot	M	SOT23	n-ch mosfet, 20V 85mA
<b>N2</b>	MMBC1653N2	Mot	N	-	npn 130V 50mA hfe 50-130
<b>N2</b>	BFS520	Phi	N	SOT323	npn RF 9GHz 70mA
<b>N3</b>	MMBC1653N3	Mot	N	-	npn 130V 50mA hfe 100-220
<b>N3</b>	MGSF1N03L	Mot	M	SOT23	n-ch TMOS mosfet 30V 0.75A
<b>N4</b>	MMBC1653N4	Mot	N	-	npn 130V 50mA hfe 150-330
<b>N5</b>	MMBC1654N5	Mot	N	-	npn 160V 50mA hfe 50-130
<b>N6</b>	MMBC1653N6	Mot	N	-	npn 160V 50mA hfe 100-220
<b>N6</b>	BFS25A	Phi	N	SOT323	npn RF 5GHz 6.5mA 32 mW
<b>N7</b>	MMBC1653N7	Mot	N	-	npn 160V 50mA hfe 150-330
<b>N9</b>	DAN222	Mot	B	SOT416	dual cc si diode
<b>N05</b>	SO2484	SGS	N	-	2N2484

N08	SO930	SGS	N	-	2N930
N10	SO918	SGS	N	-	2N918
N11	SO2369	SGS	N	-	2N2369
N12	SO2221	SGS	N	-	2N2221
N13	SO2222	SGS	N	-	2N2222
N18	SO1711	SGS	N	-	2N1711
N20	SO2222A	SGS	N	-	2N2222A
N27	SO1893	SGS	N	-	2N1893
N28	BFR520	Phi	N	SOT23	npn RF 9GHz 70mA
N29	BFR540	Phi	N	SOT23	npn RF 9GHz 120mA
N30	BFR505	Phi	N	SOT23	npn RF 9GHz 15V 18mA
N33	BFG505	Phi	TQ	SOT143	npn RF 9GHz 15V 18mA
N36	BFG520	Phi	X	SOT143	npn RF 9GHz 70mA
N37	BFG540	Phi	X	SOT143	npn RF 9GHz 120mA
N38	BFG590	Phi	TQ	SOT143	npn RF 5GHz 15V 0.2A
N39	BFG505X	Phi	X	-	npn RF 9GHz 15V 18mA
N44	BFG590X	Phi	X	-	npn RF 5GHz 15V 0.2A
N54	SO2221A	SGS	N	-	2N2221A
N70	BFG10	Phi	TQ	SOT143	npn 8V 250mA 1.8GHz pwr amp
N71	SO3904	SGS	N	-	2N3904
N71	BFG10X	Phi	X	-	8V 250mA 1.8GHz pwr amp
N72	BFG11	Phi	TQ	SOT143	8V 400mA 1.8GHz pwr amp
N72	SO3903	SGS	N	-	2N3903
N73	BFG11X	Phi	X	-	8V 400mA 1.8GHz pwr amp
N79	SO5550	SGS	N	-	2N5550
N80	SO5551	SGS	N	-	2N5551
N81	SO2369A	SGS	N	-	2N2369A
N91	SO642	SGS	N	-	npn Vce 300V
N94	SO517	SGS	N	-	npn darlington
NA	CFY35-20	Sie	DM	-	10GHz GaAsfet
NB	CFY35-23	Sie	DM	-	10GHz GaAsfet
NY	BF1012s	Sie	W	-	n-ch dg mosfet 1GHz 12V
NZ	MGSF1N02L	Mot	M	-	n-ch TMOS FET

### Codes beginning with 'O'

Code	Device	Manufacturer	Base	Package	Leaded Equivalent/Data
O (white)	BAT14-03W	Sie	I	SOD323	RF Schottky 4V 90mA
O05	SO2484R	SGS	R	-	2N2484
O08	SO930R	SGS	R	-	2N930
O10	SO918R	SGS	R	-	2N918
O12	SO2221R	SGS	R	-	2N2221
O13	SO2222R	SGS	R	-	2N2222
O2	BST82	Phi	M	SOT23	n-ch mosfet 80V 175mA
O20	SO2222AR	SGS	R	-	2N2222A
O27	SO1893R	SGS	R	-	2N1893
O54	SO2221AR	SGS	R	-	2N2221A
O79	SO5550R	SGS	R	-	2N5550
O80	SO5551R	SGS	R	-	2N5551
O91	SO642R	SGS	R	-	npn Vce 300V

### Codes beginning with 'P'

Code	Device	Manufacturer	Base	Package	Leaded Equivalent/Data
P (white)	BAT15-03W	Sie	I	SOD323	RF Schottky 4V 100mA
P	KV1841E	Tok	I	URD	uhf varicap 7-15pF
P	DAP202K	Roh	A	-	80V 100mA dual
P0	BFP90A	Phi	CX	SOT173	BFG90A
P0	TP0101T	Tem	M	SOT23	p-ch mosfet 0.5A 12V
P0	HSMS-285B	HP	C	SOT323	zero-bias schottky diode uW det

<b>P0</b>	HSMS-2850	HP	C	SOT23	zero-bias schottky diode uW det
<b>P01</b>	SO2906	SGS	N	-	2N2906
<b>P01</b>	SST201	Sil	F	SOT23	J201 n-ch fet
<b>P02</b>	SST202	Sil	F	SOT23	J202 n-ch fet
<b>P03</b>	SO2907A	SGS	N	-	2N2907A
<b>P03</b>	SST203	Sil	F	SOT23	J203 n-ch fet
<b>P04</b>	SST204	Sil	F	SOT23	J204 n-ch fet
<b>P05</b>	SO2907	SGS	N	-	2N2907
<b>P06</b>	SO2894	SGS	N	-	2N2894
<b>P1</b>	BFP91A	Phi	CX	SOT173	BFG91A
<b>P1</b>	SST201	Tem	F	SOT23	J201 n-ch jfet
<b>P1D</b>	PZTA42	Mot	P	-	MPSA42 10mA 300V npn
<b>P1F</b>	PZT2222A	Mot	P	-	2N2222A sw npn
<b>P1N</b>	PZTA14	Mot	P	-	MPSA14 darlington
<b>P1</b>	BFR92	Phi	N	SOT23	BFR90
<b>P1D</b>	PZTA42	Mot	P	-	MPSA42 300V npn
<b>P1N</b>	PZTA14	Mot	P	-	nnp darlington MPSA14
<b>P2</b>	BFR92A	Phi	N	SOT23	BFR90A
<b>P2p</b>	BFR92AW	Phi	N	SOT323	BFR90A
<b>P2</b>	HSMSM-285C	HP	D	SOT323	dual series HSMS-285B
<b>P2</b>	HSMSM-2852	HP	D	SOT23	dual series HSMS-285B
<b>P2D</b>	PZTA92	Mot	P	-	MPSA92 300V pnp
<b>P2F</b>	PZT2907A	Mot	P	-	2N2907A sw npn
<b>P2V</b>	PZTA64	Mot	P	-	MPSA64 darlington
<b>P3</b>	MMBF2202P	Mot	M	SOT23	p-ch TMOsfet 0.3A 20V
<b>P3</b>	TP0202T	Tem	M	-	p-ch mosfet 0.3A 20V
<b>P4</b>	BFR92R	Phi	R	SOT23R	BFR90
<b>P5</b>	BFR92AR	Phi	R	SOT23R	BFR90A
<b>P5</b>	FMMT2369A	Zet	N	-	2N2369A
<b>P5</b>	HSMSM-2855	HP	S	SOT143	separate pair HSMS-2850
<b>P6</b>	BFP96	Phi	CX	SOT173	BFG96
<b>P8A</b>	FLLD258	Zet	B	SOT23	low leakage dual ca Si diode
<b>P9</b>	BCX70KR	Phi	R	SOT23R	BCY59-x
<b>P9</b>	DAP222	Mot	A	SOT416	dual ca sw diode
<b>P12</b>	SO2906A	SGS	N	-	2N2906A
<b>P25</b>	SO3906	SGS	N	-	2N3906
<b>P26</b>	SO3905	SGS	N	-	2N3905
<b>P32</b>	SO5400	SGS	N	-	2N5400
<b>P33</b>	SO5401	SGS	N	-	2N5401
<b>P38</b>	SST4338	Sil	F	SOT23	2N4338
<b>P39</b>	SST4339	Sil	F	-	2N4339
<b>P39</b>	SO692	SGS	-	-	pnp Vce 300V
<b>P40</b>	SST4340	Sil	F	SOT23	2N4340
<b>P41</b>	SST4341	Sil	F	SOT23	2N4341
<b>P57</b>	SST5457	Sil	F	SOT23	2N5457
<b>P58</b>	SST5458	Sil	F	SOT23	2N5458
<b>P59</b>	SST5459	Sil	F	SOT23	2N5459
<b>P60</b>	SST5460	Sil	F	SOT23	2N5460
<b>P61</b>	SST5461	Sil	F	SOT23	2N5461
<b>P62</b>	SST5462	Sil	F	SOT23	2N5462
<b>P63</b>	SST5463	Sil	F	SOT23	2N5463
<b>P64</b>	SST5464	Sil	F	SOT23	2N5464
<b>P65</b>	SST5465	Sil	F	SOT23	2N5465
<b>PC</b>	MGSF1P02L	Mot	M	SOT23	p ch enh tmosfet
<b>PD</b>	BSS84L	Mot	M	SOT23	p-ch enh tmosfet
<b>PH2</b>	SST4302	Sil	F	SOT23	2N4302
<b>PH3</b>	SST4303	Sil	F	SOT23	2N4303
<b>PH4</b>	SST4304	Sil	F	SOT23	2N4304
<b>PL</b>	BB149A	Phi	I	SOD323	2-18pF varicap
<b>POs</b>	BAR64	Sie	C	SOT23	single 200V RF pin
<b>PPs</b>	BAR64-04	Sie	D	SOT23	dual series 200V RF pin
<b>PPs</b>	BAR64-04W	Sie	D	SOT323	dual series 200V RF pin
<b>PRs</b>	BAR64-05	Sie	B	SOT23	dual cc 200V RF pin
<b>PRs</b>	BAR64-05W	Sie	B	SOT323	dual cc 200V RF pin
<b>PSs</b>	BAR64-06	Sie	A	SOT23	dual ca 200V RF pin

PSs	BAR64-06W	Sie	A	SOT323	dual ca 200V RF pin
-----	-----------	-----	---	--------	---------------------

### Codes beginning with 'Q'

Code	Device	Manufacturer	Base	Package	Leaded Equivalent/Data
Q3	MMBC1321Q3	Mot	N	-	npn VHF amp fT 0.6GHz
Q4	MMBC1321Q4	Mot	N	-	npn VHF amp fT 0.6GHz
Q5	MMBC1321Q5	Mot	N	-	npn VHF amp fT 0.6GHz
QQ	2SC4536	Nec	P	-	npn RF fT 5.7GHz 2W hFE 40-80
QR	2SC4536	Nec	P	-	npn RF fT 5.7GHz 2W hFE 60-120
QS	2SC4536	Nec	P	-	npn RF fT 5.7GHz 2W hFE 100-200

### Codes beginning with 'R'

Code	Device	Manufacturer	Base	Package	Leaded Equivalent/Data
R	BA895	Sie	I	SCD80	-
R	BA585	Sie	I	SOD123	pin diode 50mA max
R (yellow)	BA597	Sie	I	SOD323	UHF pin diode 100mA max
R (white)	BA595	Sie	I	SOD323	UHF pin diode 50mA max
R1	BFR93	SGS	N	SOT23	BFR91
R1	HSMS-8101	HP	K	SOT23	10-14GHz schottky mixer
R1	UMT4401	Rho	N	SC70	2N4401
R1A	SST3904	Rho	N	SOT23	2N3904
R1A	UMT3904	Rho	N	SC70	2N3904
R1A	MMST3904	Rho	N	SC59	2N3904
R1G	SSTA06	Rho	N	SOT23	MPSA06
R1G	MMSTA06	Rho	N	SC59	MPSA06
R1H	SSTA05	Rho	N	SOT23	MPSA05
R1J	SST6427	Rho	N	SOT23	-
R1K	MMST6428	Rho	N	SC59	-
R1M	SSTA13	Rho	N	SOT23	MPSA13
R1M	MMSTA13	Rho	N	SC59	MPSA13
R1N	SSTA14	Rho	N	SOT23	MPSA14
R1N	MMSTA14	Rho	N	SC59	MPSA14
R1O	MMST5088	Rho	N	SC59	2N5088
R1P	SST2222A	Rho	N	SOT23	2N2222A
R1P	UMT2222A	Rho	N	SC70	2N2222A
R1P	MMST2222A	Rho	N	SC59	2N2222A
R2	BFR93A	Phi	N	SOT23	BFR91A
R2	2SC2351P	Nec	N	SOT23	npn RF fT 4.5 GHz hfe 40-120
R2	2SC4225	Nec	N	SOT323	npn RF fT 4GHz hfe 40-120
R2A	SST3906	Rho	N	SOT23	2N3906
R2A	UMT3906	Rho	N	SC70	2N3906
R2A	MMST3906	Rho	N	SC59	2N3906
R2B	MMST2907	Rho	N	SC59	2N2907
R2F	SST2907A	Rho	N	SOT23	2N2907A
R2F	UMT2907A	Rho	N	SC70	2N2907A
R2F	MMST2907A	Rho	N	SC59	2N2907A
R2G	SSTA56	Rho	N	SOT23	MPSA56
R2G	MMSTA56	Rho	N	SC59	MPSA56
R2K	MMST8598	Rho	N	SC59	-
R2O	MMST5087	Rho	N	SC59	-
R2P	MMST5086	Rho	N	SC59	-
R2T	SST4403	Rho	N	SOT23	2N4403
R2T	UMT4403	Rho	N	SC70	2N4403
R2T	MMST4403	Rho	N	SC59	2N4403
R2V	MMSTA64	Rho	N	SC59	MPSA64
R2X	SST4401	Rho	N	SCOT23	2N4401
R2X	MMST4401	Rho	N	SC59	2N4401
R3	2SC2351Q	Nec	N	SOT23	npn RF fT 4.5 GHz hfe 100-200
R3	2SC4225	Nec	N	SOT323	npn RF fT 4GHz hfe 100-200
R3B	SST918	Rho	N	SOT23	2N918
R3B	MMST918	Rho	N	SC59	2N918

<b>R4</b>	BFR93R	Tfk	R	-	BFR91
<b>R4</b>	2SC4092	Nec	WQ	SOT143	npn RF fT 6GHz hfe 40-120
<b>R5</b>	HSMS-8205	HP	S	SOT143	separate pair HSMS-8101
<b>R5</b>	BFR93AR	SGS	R	SOT23R	BFR91A
<b>R5</b>	2SC4092	Nec	WQ	SOT143	npn RF fT 6GHz hfe 100-200
<b>R6A</b>	2SC4187	Nec	N	SOT323	npn RF fT 4GHz hfe 50-100
<b>R6B</b>	2SC4187	Nec	N	SOT323	npn RF fT 4GHz hfe 80-160
<b>R6C</b>	2SC4187	Nec	N	SOT323	npn RF fT 4GHz hfe 125-250
<b>R7</b>	HSMS-8207	HP	RQ	SOT145	HSMS-8101 ring quad mixer
<b>R7</b>	BFR106	Phi	N	SOT23	BFR96S
<b>R8</b>	BFG93A	Sie	TQ	SOT143	BFG90
<b>R13</b>	2SC4885	Nec	WQ	SOT143	npn RF fT 3.5GHz
<b>R22</b>	2SC3356	Nec	N	SOT23	npn RF fT 7GHz 20V 0.2W
<b>R23</b>	2SC3356Q	Nec	N	SOT23	npn RF fT 7GHz hfe 50-100
<b>R23</b>	2SC4226	Nec	N	SOT323	npn RF fT 4.5 GHz hfe 40-80
<b>R24</b>	2SC3356R	Nec	N	SOT23	npn RF fT 7GHz hfe 80-160
<b>R24</b>	2SC4226	Nec	N	SOT323	npn RF fT 4.5 GHz hfe 70-140
<b>R25</b>	2SC3356S	Nec	N	SOT23	npn RF fT 7GHz hfe 125-250
<b>R25</b>	2SC4226	Nec	N	SOT323	npn RF fT 4.5 GHz hfe 125-250
<b>R26</b>	2SC4093Q	Nec	WQ	SOT143	npn RF fT 6.5 GHz hfe 50-100
<b>R26</b>	2SC5011Q	Nec	WQ	SOT343	npn RF fT 6.5 GHz hfe 50-100
<b>R27</b>	2SC4093R	Nec	WQ	SOT143	npn RF fT 6.5 GHz hfe 80-160
<b>R27</b>	2SC5011R	Nec	WQ	SOT343	npn RF fT 6.5 GHz hfe 80-160
<b>R28</b>	2SC4093S	Nec	WQ	SOT143	npn RF fT 6.5 GHz hfe 125-250
<b>R28</b>	2SC5011S	Nec	WQ	SOT343	npn RF fT 6.5 GHz hfe 125-250
<b>R32</b>	2SC3583	Nec	N	SOT23	npn RF fT 9GHz @ 20mA
<b>R33</b>	2SC3583Q	Nec	N	SOT23	npn RF fT 9GHz hfe 50-100
<b>R33</b>	2SC4227	Nec	N	SOT323	npn RF fT 7 GHz hfe 40-90
<b>R34</b>	2SC3583R	Nec	N	SOT23	npn RF fT 9GHz hfe 80-160
<b>R34</b>	2SC4227	Nec	N	SOT323	npn RF fT 7 GHz hfe 70-150
<b>R35</b>	2SC3583S	Nec	N	SOT23	npn RF fT 9GHz hfe 125-250
<b>R35</b>	2SC4227	Nec	N	SOT323	npn RF fT 7 GHz hfe 110-240
<b>R36</b>	2SC4094Q	Nec	WQ	SOT143	npn RF fT 9GHz hfe 50-100
<b>R36</b>	2SC5012	Nec	WQ	SOT343	npn RF fT 9GHz hfe 50-100
<b>R37</b>	2SC4094R	Nec	WQ	SOT143	npn RF fT 9GHz hfe 80-160
<b>R37</b>	2SC5012	Nec	WQ	SOT343	2SC4094 but min-mold pkg
<b>R38</b>	2SC4094S	Nec	WQ	SOT143	npn RF fT 9GHz hfe 125-250
<b>R38</b>	2SC5012	Nec	WQ	SOT343	npn RF fT 9GHz hfe 125-250
<b>R42</b>	2SC3585	Nec	N	SOT23	npn RF fT 10GHz @ 10mA
<b>R43</b>	2SC3585Q	Nec	N	SOT23	npn RF fT 10GHz hfe 50-100
<b>R43</b>	2SC4228	Nec	N	SOT323	npn RF fT 8.5GHz hfe 50-100
<b>R44</b>	2SC3585R	Nec	N	SOT23	npn RF fT 10GHz hfe 80-160
<b>R44</b>	2SC4228	Nec	N	SOT323	npn RF fT 8.5GHz hfe 80-160
<b>R45</b>	2SC3585S	Nec	N	SOT23	npn RF fT 10GHz hfe 125-250
<b>R45</b>	2SC4228	Nec	N	SOT323	npn RF fT 8.5GHz hfe 125-250
<b>R46</b>	2SC4095Q	Nec	WQ	SOT143	npn fT10GHz
<b>R46</b>	2SC5013Q	Nec	WQ	SOT343	npn fT10GHz
<b>R47</b>	2SC4095R	Nec	WQ	SOT143	npn fT10GHz
<b>R47</b>	2SC5013R	Nec	WQ	SOT343	npn fT10GHz
<b>R48</b>	2SC4095S	Nec	WQ	SOT143	npn fT10GHz
<b>R48</b>	2SC5013S	Nec	WQ	SOT343	npn fT10GHz
<b>R62</b>	2SC3663	Nec	N	SOT23	npn RF fT 4GHz @ 1mA
<b>R64</b>	2SC4091	Nec	WQ	-	npn RF fT 4GHz @ 1mA
<b>R66</b>	2SC4091Q	Nec	WQ	SOT143	npn RF fT 4GHz hfe 50-100
<b>R67</b>	2SC4091R	Nec	WQ	SOT143	npn RF fT 4GHz hfe 80-160
<b>R68</b>	2SC4091S	Nec	WQ	SOT143	npn RF fT 4GHz hfe 125-250
<b>R97</b>	SSTIS97	Rho	N	SOT23	TIS97
<b>RA</b>	BFQ81	Sie	N	SOT23	BFQ69 npn fT 5.8GHz
<b>RA</b> s	BF772	Sie	X	SOT143	npn RF TV tuners
<b>RAT</b>	SSTA28	Rho	N	SOT23	MPSA28
<b>RAT</b>	MMSTA28	Rho	N	SC59	MPSA28
<b>RAV</b>	MMST8908	Rho	N	SC59	-
<b>RBR</b>	SST6838	Rho	N	SOT23	-
<b>RB</b>	MSC1621	Mot	H	-	npn sw 20V 200MHz
<b>RB</b> s	BF771	Sie	N	SOT23	npn RF fT 8GHz

<b>RBs</b>	BF771W	Sie	N	SOT323	npn RF fT 8GHz
<b>RCs</b>	BFP193	Sie	X	SOT143	BFQ82 npn fT 8GHz
<b>RCs</b>	BFP193W	Sie	WQ	SOT343	BFQ82 npn fT 8GHz
<b>RCs</b>	BFR193	Sie	N	SOT23	BFQ82 npn fT 8GHz
<b>RCs</b>	BFR193T	Sie	N	SC75	BFQ82 npn fT 8GHz
<b>RDs</b>	BFP180	Sie	X	SOT143	npn RF 8V 4mA fT 7GHz
<b>RDs</b>	BFP180W	Sie	WQ	SOT343	npn RF 8V 4mA fT 7GHz
<b>RDs</b>	BFR180	Sie	N	SOT23	npn RF 8V 4mA fT 7GHz
<b>RDs</b>	BFR180W	Sie	N	SOT323	npn RF 8V 4mA fT 7GHz
<b>REs</b>	BFS480	Sie	DJ	SOT363	dual RF npn fT 7GHz
<b>REs</b>	BFR280	Sie	N	SOT23	npn RF 8V 8mA fT 7.5GHz
<b>REs</b>	BFR280W	Sie	N	SOT323	npn RF 8V 8mA fT 7.5GHz
<b>REs</b>	BFP280	Sie	X	SOT143	npn RF 8V 8mA fT 7.5GHz
<b>REs</b>	BFP280W	Sie	WQ	SOT343	npn RF 8V 8mA fT 7.5GHz
<b>RE</b>	2SC3357	Nec	P	SOT89	npn RF 1.2W fT 6.5GHz
<b>RFs</b>	BFR181	Sie	N	SOT23	npn RF 12V 20mA fT 8GHz
<b>RFs</b>	BFP181	Sie	X	SOT143	npn RF 12V 20mA fT 8GHz
<b>RFs</b>	BFP181W	Sie	WQ	SOT343	npn RF 12V 20mA fT 8GHz
<b>RFs</b>	BFS481	Sie	DJ	SOT363	Dual BFR181
<b>RF</b>	2SC3357	Nec	P	SOT89	npn RF 1.2W fT 6.5GHz
<b>RFQ</b>	SST6839	Rho	N	SOT23	-
<b>RGs</b>	BFR182	Sie	N	SOT23	npn RF12V 35mA fT 8GHz
<b>RGs</b>	BFR182W	Sie	N	SOT323	npn RF12V 35mA fT 8GHz
<b>RGs</b>	BFP182	Sie	X	SOT143	npn RF12V 35mA fT 8GHz
<b>RGs</b>	BFP182W	Sie	WQ	SOT343	npn RF12V 35mA fT 8GHz
<b>RGs</b>	BFR182T	Sie	N	SC75	npn RF12V 35mA fT 8GHz
<b>RGs</b>	BFS482	Sie	DJ	SOT363	Dual BFR182
<b>RHs</b>	BFR183	Sie	N	SOT23	npn RF 12V 65mA fT 8GHz
<b>RHs</b>	BFR183W	Sie	N	SOT323	npn RF 12V 65mA fT 8GHz
<b>RHs</b>	BFR183T	Sie	N	SC75	npn RF 12V 65mA fT 8GHz
<b>RHs</b>	BFP183	Sie	X	SOT143	npn RF 12V 65mA fT 8GHz
<b>RHs</b>	BFP183W	Sie	WQ	SOT343	npn RF 12V 65mA fT 8GHz
<b>RH</b>	2SC3357	Nec	P	SOT89	npn RF 1.2W fT 6.5GHz
<b>RHs</b>	BFS483	Sie	DJ	SOT363	Dual BFR183 npn RF
<b>RI</b>	BFP196	Sie	X	SOT143	pnnp RF 12V 100mA Ft 7.5GHz
<b>RKs</b>	BFP194	Sie	X	SOT143	pnnp RF 15V 100mA Ft 5GHz
<b>RKs</b>	BFR194	Sie	N	SOT233	pnnp RF 15V 100mA Ft 5GHz
<b>RKM</b>	RK7002	Rho	-	SOT23	-
<b>RK</b>	2SC3357	Nec	P	SOT89	npn RF 1.2W fT 6.5GHz
<b>RR</b>	BBY59-02V	Inf	I	SC79	hyperabrupt varicap 7-28pF
<b>RR</b>	BFR93P	Sie	N	SOT23	BFR91
<b>RVZ</b>	MMST4126	Rho	N	SC59	2N4126
<b>RW</b>	BFR194	Sie	N	-	pnnp RF amp 1.5GHz
<b>RZC</b>	SST4124	Rho	N	SOT23	2N4124
<b>RZC</b>	MMST4124	Rho	N	SC59	2N4124

### Codes beginning with 'S'

Code	Device	Manufacturer	Base	Package	Leaded Equivalent/Data
<b>S (blue)</b>	BA592	Sie	I	SOD323	BA282
<b>S (red)</b>	BB640	Sie	I	SOD323	70-3pF varicap
<b>S (white)</b>	BB535	Sie	I	SOD323	18-2pF varicap
<b>S (yellow)</b>	BB639	Sie	I	SOD323	39-2.7pF varicap
<b>S</b>	BB811	Sie	I	-	9.8pF @ 1V 30V max
<b>S</b>	BAP64-02	Phi	I	SOD523	3GHz pin diode
<b>S0</b>	HSMP-3880	HP	C	SOT23	pin sw diode
<b>S1</b>	HSMP-3881	HP	K	SOT23	pin sw diode
<b>S1</b>	BBY31	Phi	C	SOT23	BB405
<b>S1A</b>	S1A	Fch	I	DO214	1N4001
<b>S1B</b>	S1B	Fch	I	DO214	1N4002
<b>S1D</b>	S1D	Fch	I	DO214	1N4003
<b>S1G</b>	S1G	Fch	I	DO214	1N4004
<b>S1J</b>	S1J	Fch	I	DO214	1N4005
<b>S2</b>	BBY40	Phi	C	SOT23	BB809

S2	BFQ31	Zet	N	-	npn vhf 15V 0.1A
S3	BFQ31R	Zet	R	-	npn vhf 15V 0.1A
S3	BBY51	Sie	B	SOT23	dual cc varicap
S4	BFQ31A	Zet	N	-	npn vhf 15V 0.1A
S5	BFQ31AR	Zet	R	-	npn vhf 15V 0.1A
S5	BBY52	Sie	B	SOT23	dual cc varicap
S5	BAT15-099	Sie	NQ	SOT143	Dual BAT15 schottky
S6	BAT15-099R	Sie	DQ	-	Ring quad BAT15 schottky
S6	BF510	Phi	G	-	BF410A
S7	BF511	Phi	G	-	BF410B
S7	SST177	Tem	F	SOT23	J177 p-ch analog sw jfet
S7s	BBY53-05	Sie	B	SOT23	dual cc varicap
S7s	BBY53-05W	Sie	B	SOT323	dual cc varicap
S7	BAT114-099	Sie	NQ	SOT143	Dual schottky
S8	BF512	Phi	G	-	BF410C
S8	BAT14-099	Sie	NQ	SOT143	Dual schottky
S9	BAT14-099R	Sie	DQ	-	Quad crossover ring schottky
S9	BF513	Phi	G	-	BF410D
S12	BBY39	Phi	B	SOT23	2x BBY31
S14	SST5114	Sil	F	SOT23	2N5114
S15	SST5115	Sil	F	SOT23	2N5115
S16	SST5116	Sil	F	SOT23	2N5116
S16	ZHCS1006	Zet	E	SOT23	60V 1A schottky diode
S56	ZHCS506	Zet	E	SOT23	60V 0.5A schottky diode
S70	SST270	Sil	F	SOT23	J270 p-ch jfet
S71	SST271	Sil	F	SOT23	J271 p-ch jfet
S74	SST174	Sil	F	SOT23	J174 p-ch fet
S75	SST175	Sil	F	SOT23	J175 p-ch fet
S76	SST176	Sil	F	SOT23	J176 p-ch fet
S76	ZHCS756	Zet	E	SOT23	60V 0.75A schottky diode
S77	SST177	Sil	F	SOT23	J177 p-ch fet
SA	BSS123	Sie	M	SOT23	n-ch mosfet 100V 0.17A
SD	BSS284	Sie	M	SOT23	p-ch mosfet 50V 0.13A
SE	2SC4703	Nec	P	-	npn RF 1.8W fT 6GHz
SF	2SC4703	Nec	P	-	npn RF 1.8W fT 6GHz
SFs	BB804	Sie	A	SOT23	dual 45-26pF cc VHF varicap
sSG	SN7002	Sie	M	SOT23	n-ch mosfet 60V 0.19A
SH	2SC4703	Nec	P	-	npn RF 1.8W fT 6GHz
SH2	BB814	Sie	A	SOT23	dual 45-20pF cc varicap
SM	BB914	Sie	B	SOT23	dual varicap for FM radio
SR	BSS131	Sie	M	SOT23	n-ch mosfet 240V 0.1A
SP	BSS84	Sie	M	SOT23	p-ch mosfet 50V 0.13A
SS	BSS138	Sie	M	SOT23	n-ch mosfet 50V 0.22A
ST	BSS139	Sie	M	SOT23	n-ch dep mosfet 250V 0.04A

### Codes beginning with 'T'

Code	Device	Manufacturer	Base	Package	Leaded Equivalent/Data
T	BB515	Sie	I	SOD323	varicap 17.7pf @ 1V 30V max
T	BAR67-02W	Sie	I	SCD80	-
T0	TP0601T	Tem	M	-	p-ch mosfet 60V 0.12A
T0	HSMS-2860	HP	C	SOT23	zero bias schottky diode
T0	HSMS-286B	HP	C	SOT323	zero bias schottky diode
T1	BCX17	Phi	N	SOT23	BC327
T1p	BCX17	Phi	N	SOT23	BC327
T1t	BCX17	Phi	N	SOT23	BC327
T1	IMT1A	Roh	DA	-	2 x 2SA1037AK pnp
T1	BSS63	Mot	N	SOT23	pnp 100V 0.1A
T2	BCX18	Phi	N	SOT23	BC328
T2p	BCX18	Phi	N	SOT23	BC328
T2t	BCX18	Phi	N	SOT23	BC328
T2	IMT2A	Roh	DB	-	2 x 2SA1037AK pnp
T2	HSMS-286C	HP	D	SOT323	dual series HSMS-286B
T2	HSMS-2862	HP	D	SOT23	dual series HSMS-286B



T3	BSS63	Phi	N	SOT23	BSS68
T3	HSMS-286E	HP	A	SOT323	ca dual HSMS-286B
T3	HSMS-2863	HP	A	SOT23	ca dual HSMS-286B
T4	BCX17R	Phi	R	SOT23R	BC327
T4	HSMS-286F	HP	B	SOT323	cc dual HSMS-286B
T4	HSMS-2864	HP	B	SOT23	cc dual HSMS-286B
T4	MBD330DW	Mot	DL	SOT363	dual UHF schottky diode
T5	HSMS-2865	HP	S	SOT143	separate dual HSMS-286B
T5	BCX18R	Phi	R	SOT23R	BC328
T6	BSS63R	Phi	R	SOT23R	BSS68
T7	BSR15	SGS	N	SOT23	2N2907
T7p	BSR15	Phi	N	SOT23	2N2907
T7t	BSR15	Phi	N	SOT23	2N2907
T8	BSR16	SGS	N	SOT23	2N2907A
T8p	BSR16	Phi	N	SOT23	2N2907A
T8t	BSR16	Phi	N	SOT23	2N2907A
T32	2SC4182	Nec	N	SOT23	npn RF fT 1.1GHz @3V hfe 60-105
T33	2SC4182	Nec	N	SOT23	npn RF fT 1.1GHz @3V hfe 85-150
T34	2SC4182	Nec	N	SOT23	npn RF fT 1.1GHz @3V hfe 120-220
T42	2SC3545P	Nec	N	-	npn RF fT 2GHz hfe 50-100
T42	2SC4184	Nec	N	SOT323	npn RF fT1.8GHz hfe 40-80
T43	2SC3545Q	Nec	N	-	UHF osc/mix fT 2GHz hfe 70-140
T43	2SC4184	Nec	N	SOT323	npn fT1.8GHz hfe 60-120
T44	2SC3545R	Nec	N	-	npn RF fT 2GHz hfe 120-250
T44	2SC4184	Nec	N	SOT323	npn RF fT1.8GHz hfe 100-200
T62	2SC3841P	Nec	N	SOT23	npn RF fT 4GHz hfe 40-80
T62	2SC4186	Nec	N	SOT323	npn RF fT 4GHz hfe 40-80
T63	2SC3841Q	Nec	N	SOT23	npn RF fT 4GHz hfe 60-120
T63	2SC4186	Nec	N	SOT323	npn RF fT 4GHz hfe 60-120
T64	2SC3841R	Nec	N	SOT23	npn RF fT 4GHz hfe 100-200
T64	2SC4186	Nec	N	SOT323	npn RF fT 4GHz hfe 100-200
T71	BSR15R	SGS	R	SOT23R	2N2907
T72	2SC4568	Nec	N	SOT23	npn RF ft 5.5GHz hfe 40-80
T72	2SC4570	Nec	N	SOT323	npn RF ft 5.5GHz hfe 40-80
T73	2SC4568	Nec	N	SOT23	npn RF ft 5.5GHz hfe 60-120
T73	2SC4570	Nec	N	SOT323	npn RF ft 5.5GHz hfe 60-120
T74	2SC4568	Nec	N	SOT23	npn RF ft 5.5GHz hfe 100-200
T74	2SC4570	Nec	N	SOT323	npn RF ft 5.5GHz hfe 100-200
T75	2SC4569	Nec	N	SOT23	npn RF fT 5GHz hfe 40-80
T75	2SC4571	Nec	N	SOT323	npn RF fT 5GHz hfe 40-80
T76	2SC4569	Nec	N	SOT23	npn RF fT 5GHz hfe 60-120
T76	2SC4571	Nec	N	SOT323	npn RF fT 5GHz hfe 60-120
T77	2SC4569	Nec	N	SOT23	npn RF fT 5GHz hfe 100-200
T76	2SC4571	Nec	N	SOT323	npn RF fT 5GHz hfe 100-200
T78	2SC5507	Nec	WQ	SOT343	npn RF fT 25GHz 3V 10mA
T79	2SC5508	Nec	WQ	SOT343	npn RF fT 25GHz 3V 30mA
T80	2SC5507	Nec	WQ	SOT343	npn RF fT 17GHz 3V 90mA
T81	BSR16R	SGS	R	SOT23R	2N2907A
T82	2SC4954	Nec	N	SOT23	npn RF fT12GHz @3V 5mA
T82	2SC4956	Nec	WQ	SOT143	npn RF fT 12GHz @3V 5mA
T82	2SC4958	Nec	N	SOT323	npn RF fT 12GHz @3V 5mA
T82	2SC5014	Nec	WQ	SOT343	npn RF fT 12GHz @3V 5mA
T83	2SC4955	Nec	N	SOT23	npn RF fT 12GHz @3V 10mA
T83	2SC4957	Nec	WQ	SOT143	npn RF fT 12GHz @3V 10mA
T83	2SC4959	Nec	N	SOT323	npn RF fT 12GHz @3V 10mA
T83	2SC5015	Nec	WQ	SOT343	npn RF fT 12GHz @3V 10mA
T84	2SC5177	Nec	N	SOT23	npn RF fT 13GHz @2V 7mA
T84	2SC5179	Nec	N	SOT323	npn RF fT 13GHz @2V 7mA
T84	2SC5178	Nec	WQ	SOT143	npn RF fT 13GHz @2V 7mA
T84	2SC5180	Nec	WQ	SOT343	npn RF fT 13GHz @2V 7mA
T86	2SC5182	Nec	N	SOT23	npn RF fT 12GHz @2V 20mA
T86	2SC5183	Nec	WQ	SOT143	npn RF fT 12GHz @2V 20mA
T86	2SC5184	Nec	N	SOT323	npn RF fT 12GHz @2V 20mA
T86	2SC5183	Nec	WQ	SOT343	npn RF fT 12GHz @2V 20mA
T88	2SC5191	Nec	N	SOT23	npn RF fT 8.5GHz @3V 20mA

<b>T88</b>	2SC5192	Nec	WQ	SOT143	npn RF fT 8.5GHz @3V 20mA
<b>T88</b>	2SC5193	Nec	N	SOT323	npn RF fT 8.5GHz @3V 20mA
<b>T88</b>	2SC5193	Nec	WQ	SOT343	npn RF fT 8.5GHz @3V 20mA
<b>T89</b>	2SC5288	Nec	WQ	SOT143	npn RF
<b>T90</b>	2SC5289	Nec	WQ	SOT143	npn RF
<b>T92</b>	BSR18A	Fch	N	SOT23	2N3904
<b>T92P</b>	BSR18A	Phi	N	SOT23	2N3904
<b>T92</b>	2SA1977	Nec	N	SOT23	npn RF fT 8.5GHz
<b>T93</b>	2SA1978	Nec	N	SOT23	npn RF fT 8.5GHz
<b>TA</b>	2SC5431EB	Nec	N	SC59	npn RF fT 4.3GHz 12V 60mA
<b>TB</b>	2SC5431FB	Nec	N	SC59	npn RF fT 4.3GHz 12V 60mA
<b>TC</b>	2SC5432EB	Nec	N	SC59	npn RF fT 4.5GHz 12V 100mA
<b>TD</b>	2SC5432FB	Nec	N	SC59	npn RF fT 4.5GHz 12V 100mA
<b>TE</b>	2SC5433EB	Nec	N	SC59	npn RF fT 7GHz 10V 65mA
<b>TF</b>	2SC5433FB	Nec	N	SC59	npn RF fT 7GHz 10V 65mA
<b>TFX</b>	BAL99	Mot	V	SOT23	switching diode
<b>TH</b>	2SC5434EB	Nec	N	SC59	npn RF fT 8GHz 10V 35mA
<b>TJ</b>	2SC5434FB	Nec	N	SC59	npn RF fT 8GHz 10V 35mA
<b>TK</b>	2SC5435EB	Nec	N	SC59	npn RF fT 12GHz 9V 30mA
<b>TL</b>	2SC5435FB	Nec	N	SC59	npn RF fT 12GHz 9V 30mA
<b>TN</b>	2SC5436EB	Nec	N	SC59	npn RF fT 14GHz 5V 30mA
<b>TP</b>	2SC5436FB	Nec	N	SC59	npn RF fT 14GHz 5V 30mA
<b>TS</b>	2SC5437EB	Nec	N	SC59	npn RF fT 9.5GHz 9V 50mA
<b>TT</b>	2SC5437FB	Nec	N	SC59	npn RF fT 9.5GHz 9V 50mA
<b>TV</b>	2SC5599	Nec	N	SC-70	npn RF fT 5GHz 5.5V 5mA
<b>TV</b>	2SC5600	Nec	N	SC-59	npn RF fT 5GHz 5.5V 15mA
<b>TV</b>	MMBF112L	Mot	F	SOT23	RF jfet
<b>TW</b>	2SC5602	Nec	N	SC-70	npn RF fT 13.5GHz 6V 5mA
<b>TW</b>	2SC5603	Nec	N	SC-59	npn RF fT 13.5GHz 6V 15mA

### Codes beginning with 'U'

Code	Device	Manufacturer	Base	Package	Leaded Equivalent/Data
<b>U</b>	BB545	Sie	I	SOD323	20-2pF varicap
<b>U1</b>	BCX19	Mot	N	SOT23	BC337
<b>U1p</b>	BCX19	Phi	N	SOT23	BC337
<b>U1t</b>	BCX19	Phi	N	SOT23	BC337
<b>U1</b>	BGX50A	Sie	BQ	SOT143	quad ring Si sw diodes
<b>U1A</b>	3SK230A	Nec	UQ	SOT143	dg RF mosfet
<b>U1B</b>	3SK230B	Nec	UQ	SOT143	dg RF mosfet
<b>U1C</b>	3SK231C	Nec	UQ	SOT143	dg RF mosfet
<b>U1D</b>	3SK231D	Nec	UQ	SOT143	dg RF mosfet
<b>U1E</b>	3SK252E	Nec	UQ	SOT143	dg RF mosfet
<b>U1E</b>	3SK254E	Nec	UQ	SOT343	dg RF mosfet
<b>U1G</b>	3SK253G	Nec	UQ	SOT143	dg RF mosfet
<b>U1G</b>	3SK255G	Nec	UQ	SOT343	dg RF mosfet
<b>U2</b>	BCX20	Phi	N	SOT23	BC338
<b>U2t</b>	BCX20	Phi	N	SOT23	BC338
<b>U3</b>	BSS64	Phi	N	SOT23	120V 0.25A 0.2W
<b>U4</b>	BCX19R	Phi	R	SOT23R	BC337
<b>U5</b>	BCX20R	Phi	R	SOT23R	BC338
<b>U6</b>	BSS64R	Phi	R	SOT23R	120V 0.25A 0.2W
<b>U7</b>	BSR13	SGS	N	SOT23	2N2222
<b>U7p</b>	BSR13	Phi	N	SOT23	2N2222
<b>U7t</b>	BSR13	Phi	N	SOT23	2N2222
<b>U8</b>	BSR14	SGS	N	SOT23	2N2222A
<b>U8p</b>	BSR14	Phi	N	SOT23	2N2222A
<b>U8t</b>	BSR14	Phi	N	SOT23	2N2222A
<b>U16</b>	2SC4183	Nec	N	-	npn RF 5V fT1GHz hFE 60-120
<b>U17</b>	2SC4183	Nec	N	-	npn RF 5V fT1GHz hFE 90-180
<b>U18</b>	2SC4183	Nec	N	-	npn RF 5V fT1GHz hFE 120-240
<b>U21</b>	2SC4185	Nec	N	-	npn RF 10V fT2.4GHz hFE 40-80
<b>U22</b>	2SC4185	Nec	N	-	npn RF 10V fT2.4GHz hFE 60-120
<b>U23</b>	2SC4185	Nec	N	-	npn RF 10V fT2.4GHz hFE 90-180

U55	3SK134B	Nec	UQ	SOT143	dg mosfet
U55	3SK245	Nec	UQ	SOT343	dg mosfet
U56	3SK134B	Nec	UQ	SOT143	dg mosfet
U56	3SK245	Nec	UQ	SOT343	dg mosfet
U65	3SK135A	Nec	UQ	SOT143	dg mosfet
U66	3SK135A	Nec	UQ	SOT143	dg mosfet
U71	BSR13R	SGS	R	SOT23R	2N2222
U71	3SK177	Nec	UQ	SOT143	dg GaAsfet Idss 5-15mA
U71	3SK299	Nec	UQ	SOT343	dg GaAsfet Idss 5-15mA
U72	3SK177	Nec	UQ	SOT143	dg GaAsfet Idss10-25mA
U72	3SK299	Nec	UQ	SOT343	dg GaAsfet Idss 10-25mA
U73	3SK177	Nec	UQ	SOT143	dg GaAsfet Idss 20-35mA
U73	3SK299	Nec	UQ	SOT343	dg GaAsfet Idss 20-35mA
U74	3SK177	Nec	UQ	SOT143	dg GaAsfet Idss 30-40mA
U74	3SK299	Nec	UQ	SOT343	dg GaAsfet Idss 30-40mA
U76	3SK206	Nec	UQ	SOT143	dg GaAsfet Idss 10-25mA
U77	3SK206	Nec	UQ	SOT143	dg GaAsfet Idss 20-35mA
U78	3SK206	Nec	UQ	SOT143	dg GaAsfet Idss 30-50mA
U79	3SK206	Nec	UQ	SOT143	dg GaAsfet Idss 45-80mA
U81	BSR14R	SGS	R	SOT23R	2N2222A
U87	3SK176A	Nec	UQ	SOT143	dg mosfet
U88	3SK176A	Nec	UQ	SOT143	dg mosfet
U90	3SK223	Nec	UQ	SOT143	dg mosfet
U90	3SK243	Nec	UQ	SOT343	dg mosfet
U91	3SK223	Nec	UQ	SOT143	dg mosfet
U91	3SK243	Nec	UQ	SOT143	dg mosfet
U92	BSR17A	Fch	N	SOT23	2N3904
U92p	BSR17A	Phi	N	SOT23	2N3904
U94	3SK224D	Nec	UQ	SOT143	dg mosfet
U94	3SK244D	Nec	UQ	SOT343	dg mosfet
U95	3SK224E	Nec	UQ	SOT143	dg mosfet
U95	3SK244E	Nec	UQ	SOT143	dg mosfet
UB	2SB852K	Roh	N	-	npn darlington comp 2SD1383K
UC	MSC2404-C	Mot	H	-	npn RF 450MHz fT 20V

### Codes beginning with 'V'

Code	Device	Manufacturer	Base	Package	Leaded Equivalent/Data
V01	VN50300T	Sil	M	-	n-ch enh mosfet 500V 22mA
V02	VN0605T	Sil	M	-	n-ch enh mosfet 60V/0.18A
V04	VN45350T	Sil	M	-	n-ch enh mosfet 450V 20mA
V1p	BFT25	Phi	N	SOT23	npn RF 5V 6.5mA 2.3GHz
V1	MRF959	Mot	N	SC75	npn RF fT 9GHz
V2	BFG67	Tfk	N	-	npn RF fT 7.5 GHz 50mA
V3	BFG67	Phi	X	SOT143	npn RF fT 8GHz 50mA
V5	BFG197	Phi	X	SOT143	npn RF 7.5GHz 100mA
V11	3SK131	Nec	UQ	SOT143	dg VHF mosfet
V11	3SK242	Nec	UQ	SOT343	dg VHF mosfet
V12	3SK131	Nec	UQ	SOT143	dg VHF mosfet
V12	3SK242	Nec	UQ	SOT343	dg VHF mosfet
V13	3SK131	Nec	UQ	SOT143	dg VHF mosfet
V13	ZC932	Zet	C	SOT23	5 - 17pF hyperabrupt varicap
V13	3SK242	Nec	UQ	SOT343	dg VHF mosfet
V14	ZC931	Zet	C	SOT23	4 - 13.5pF hyperabrupt varicap
V15	ZC930	Zet	C	SOT23	3 - 9pF hyperabrupt varicap
V16	ZC934	Zet	C	SOT23	25 - 95pF hyperabrupt varicap
V17	ZC933	Zet	C	SOT23	12 - 42pF hyperabrupt varicap
V21	3SK222	Nec	UQ	SOT143	dg VHF mosfet
V21	3SK246	Nec	UQ	SOT343	dg VHF mosfet
V22	3SK222	Nec	UQ	SOT143	dg VHF mosfet
V22	3SK246	Nec	UQ	SOT343	dg VHF mosfet

<b>V50</b>	VP0610T	Sil	M	-	p-ch enh mosfet -60V 120mA
<b>VB</b>	MSC2295-B	Mot	H	-	npn RF 150MHz fT 20V
<b>VC</b>	MSC2295-C	Mot	H	-	npn RF 150MHz fT 20V

### Codes beginning with 'W'

Code	Device	Manufacturer	Base	Package	Leaded Equivalent/Data
<b>W0F</b>	TSDF1205RW	Tfk	WQ	SOT343	12GHz npn 5mA 4V
<b>W1s</b>	BFT92	Sie	N	SOT23	BFQ51/BFQ76
<b>W1s</b>	BCR10PN	Sie	DP	SOT363	pnp/npn dig 0.1A 10k+10k
<b>W2</b>	TSDF1220RW	Tfk	WQ	SOT343	12GHz npn 6V 20mA
<b>W3</b>	BZX84-C2V4	Phi	C	SOT23	0.3W zener 2.4V±5%
<b>W4</b>	BZX84-C2V7	Phi	C	SOT23	0.3W zener 2.7V±5%
<b>W5</b>	BZX84-C3V0	Phi	C	SOT23	0.3W zener 3.0V±5%
<b>W6</b>	BZX84-C3V3	Phi	C	SOT23	0.3W zener 3.3V±5%
<b>W7</b>	BZX84-C3V6	Phi	C	SOT23	0.3W zener 3.6V±5%
<b>W8</b>	BZX84-C3V9	Phi	C	SOT23	0.3W zener 3.9V±5%
<b>W8</b>	BZV49C3V9	Zet	O	SOT89	1W zener 3.9V±5%
<b>W9</b>	BZX84-C4V3	Phi	C	SOT23	0.3W zener 4.3V±5%
<b>W9</b>	BZV49C4V3	Zet	O	SOT89	1W zener 4.3V±5%
<b>W18</b>	BFP181TW	Tfk	X	-	npn RF fT 7.8GHz 10V 20mA
<b>W18</b>	BFP181TRW	Tfk	WQ	-	npn RF fT 7.8GHz 10V 20mA
<b>W22</b>	S822TW	Tfk	X	-	npn rf fT 5.2 GHz 6V 8mA
<b>W22</b>	S822TRW	Tfk	WQ	-	npn rf fT 5.2 GHz 6V 8mA
<b>W28</b>	BFP280TRW	Tfk	WQ	-	npn rf fT 7 GHz 8V 10mA
<b>W28</b>	BFP280TW	Tfk	X	-	npn rf fT 7 GHz 8V 10mA
<b>W52</b>	S852TW	Tfk	X	-	npn rf fT 5.2 GHz 6V 8mA
<b>W67</b>	BFP67W	Tfk	X	-	npn rf fT 7.5 GHz 10V 50mA
<b>W82</b>	BFP182TRW	Tfk	WQ	-	npn rf fT 7.5 GHz 10V 35mA
<b>W82</b>	BFP182TW	Tfk	X	-	npn rf fT 7.5 GHz 10V 35mA
<b>W83</b>	BFP183TRW	Tfk	WQ	-	npn rf fT 7.4 GHz 10V 65mA
<b>W83</b>	BFP183T	Tfk	X	-	npn rf fT 7.4 GHz 10V 65mA
<b>W92</b>	BFP92AW	Tfk	X	SOT343	npn rf fT 6 GHz 15V 30mA
<b>WB</b>	2SD1383K	Roh	N	-	npn darlington comp 2SB852K
<b>WCs</b>	BCR133	Sie	N	SOT23	npn dig 50V 0.1A 10k+10k
<b>WCs</b>	BCR133T	Sie	N	SC75	npn dig 50V 0.1A 10k+10k
<b>WCs</b>	BCR133U	Sie	N	SOT457	npn dig 50V 0.1A 10k+10k
<b>WCs</b>	BCR133W	Sie	N	SOT323	npn dig 50V 0.1A 10k+10k
<b>WCs</b>	BCR133S	Sie	DN	SOT363	dual BCR133
<b>WDs</b>	BCR141	Sie	N	SOT23	npn 50V 0.1A dig 22k +22k
<b>WDs</b>	BCR141T	Sie	N	SC75	npn 50V 0.1A dig 22k +22k
<b>WDs</b>	BCR141W	Sie	N	SOT323	npn 50V 0.1A dig 22k +22k
<b>WDs</b>	BCR141S	Sie	DN	SOT363	dual BCR141
<b>WEs</b>	BCR148	Sie	N	SOT23	npn 50V 0.1A dig 47k +47k
<b>WEs</b>	BCR148T	Sie	N	SC75	npn 50V 0.1A dig 47k +47k
<b>WEs</b>	BCR148U	Sie	N	SOT457	npn 50V 0.1A dig 47k +47k
<b>WEs</b>	BCR148W	Sie	N	SOT323	npn 50V 0.1A dig 47k +47k
<b>WEs</b>	BCR148S	Sie	DN	SOT363	dual BCR148
<b>WE1</b>	BFS17W	Tfk	N	-	npn rf fT 2.1GHz SOT-323
<b>WE2</b>	BFS17AW	Tfk	N	-	npn rf fT 3.2GHz SOT-323
<b>WFs</b>	BCR08PN	Sie	DP	SOT363	pnp/npn dig 0.1A 2k2+47k
<b>WFs</b>	BCR112	Sie	N	SOT23	npn dig 50V 0.1A 4k7+4k7
<b>WF0</b>	TSDF1205W	Tfk	X	SOT343	12 GHz npn 5mA 4V
<b>WF2</b>	TSDF1220W	Tfk	X	SOT343	12GHz npn 6V 20mA
<b>WFE</b>	BFP93A	Tfk	X	SOT343	BFP93A (FE) in 6GHz npn
<b>WGs</b>	BCR116	Sie	N	SOT23	npn dig 50V 0.1A 4k7+47k
<b>WGs</b>	BCR116W	Sie	N	SOT323	npn dig 50V 0.1A 4k7+47k
<b>WHs</b>	BCR108	Sie	N	SOT23	npn dig 50V 0.1A 2k2+47k
<b>WHs</b>	BCR108T	Sie	N	SC75	npn dig 50V 0.1A 2k2+47k
<b>WHs</b>	BCR108W	Sie	N	SOT323	npn dig 50V 0.1A 2k2+47k
<b>WHs</b>	BCR108S	Sie	DN	SOT363	dual BCR108
<b>WIs</b>	BCR158	Sie	N	SOT23	pnp dig 50V 0.1A 2k2+47k
<b>WIs</b>	BCR158T	Sie	N	SC75	pnp dig 50V 0.1A 2k2+47k
<b>WIs</b>	BCR158W	Sie	N	SOT323	pnp dig 50V 0.1A 2k2+47k

<b>WJs</b>	BCR135	Sie	N	SOT23	npn dig 50V 0.1A 10k+47k
<b>WJs</b>	BCR135T	Sie	N	SC75	npn dig 50V 0.1A 10k+47k
<b>WJs</b>	BCR135W	Sie	N	SOT323	npn dig 50V 0.1A 10k+47k
<b>WJs</b>	BCR135S	Sie	DN	SOT363	dual BCR135
<b>WKS</b>	BCR119	Sie	N	SOT23	npn dig 50V 0.1A 4k7
<b>WKS</b>	BCR119S	Sie	DN	SOT363	npn dig 50V 0.1A 4k7
<b>WKS</b>	BCR119W	Sie	N	SOT323	npn dig 50V 0.1A 4k7
<b>WLS</b>	BCR146	Sie	N	SOT23	dual npn dig 50V 47k+22k
<b>WLS</b>	BCR146W	Sie	N	SOT323	dual npn dig 50V 47k+22k
<b>WMS</b>	BCR183	Sie	N	SOT23	pnp dig 50V 10k+10k
<b>WMS</b>	BCR183W	Sie	N	SOT323	pnp dig 50V 10k+10k
<b>WMS</b>	BCR183T	Sie	N	SC75	pnp dig 50V 10k+10k
<b>WMS</b>	BCR183U	Sie	N	SOT457	pnp dig 50V 10k+10k
<b>WMS</b>	BCR183S	Sie	DO	SOT363	dual pnp dig 50V 10k+10k
<b>WMO</b>	BF998RW	Tfk	UQ	SOT343R	vhf dg mosfet BF988
<b>WNS</b>	BCR185	Sie	N	SOT23	pnp dig 50V 0.1A 10k+47k
<b>WNS</b>	BCR185U	Sie	N	SOT457	pnp dig 50V 0.1A 10k+47k
<b>WNS</b>	BCR185W	Sie	N	SOT323	pnp dig 50V 0.1A 10k+47k
<b>WNS</b>	BCR185S	Sie	DO	SOT363	dual BCR185
<b>WOS</b>	BCR191	Sie	N	SOT23	pnp dig 50V 0.1A 22k+22k
<b>WOS</b>	BCR191W	Sie	N	SOT323	pnp dig 50V 0.1A 22k+22k
<b>WOS</b>	BCR191S	Sie	DO	SOT363	dual BCR191
<b>WO</b>	BZX284-B2V4	Phi	I	SOD110	0.4W zener 2.4V E24 ±2%
<b>WP</b>	BZX284-B2V7	Phi	I	SOD110	0.4W zener 2.7V E24 ±2%
<b>WPs</b>	BCR192	Sie	N	SOT23	pnp dig 50V 0.1A 22k+47k
<b>WPs</b>	BCR192T	Sie	N	SC75	pnp dig 50V 0.1A 22k+47k
<b>WPs</b>	BCR192W	Sie	N	SOT323	pnp dig 50V 0.1A 22k+47k
<b>WPs</b>	BCR22PN	Sie	DP	SOT363	pnp/npn dig 0.1A 22k+22k
<b>WP2</b>	BFR92A	Tfk	N	SOT23	BRF90A
<b>WQ</b>	BZX284-B3V0	Phi	I	SOD110	0.4W zener 3.0V E24 ±2%
<b>WR</b>	MSD602R	Mot	N	SOT346	npn gp 25V 150mA
<b>WRs</b>	BCR198	Sie	N	SOT23	pnp dig 50V 0.1A 47k+47k
<b>WRs</b>	BCR198W	Sie	NN	SOT323	pnp dig 50V 0.1A 47k+47k
<b>WRs</b>	BCR198S	Sie	D	SOT363	dual BCR198
<b>WR</b>	BZX284-B3V3	Phi	I	SOD110	0.4W zener 3.3V E24 ±2%
<b>WR2</b>	BFR93AW	Tfk	N	-	BRF91A
<b>WRE</b>	BFR280TW	Tfk	N	-	npn RF ft 7.5GHz
<b>WRF</b>	BFR181TW	Tfk	N	-	npn RF ft 7.8GHz
<b>WRG</b>	BFR182TW	Tfk	N	-	npn RF ft 7GHz
<b>WRH</b>	BFR183TW	Tfk	N	-	npn RF ft 7.4GHz
<b>WS</b>	BCR169	Sie	N	SOT23	pnp dig 50V 0.1A 4k7
<b>WS</b>	BCR169W	Sie	N	SOT323	pnp dig 50V 0.1A 4k7
<b>WS</b>	BCR169S	Sie	DO	SOT363	dual BC169
<b>WS</b>	BZX284-B3V6	Phi	I	SOD110	0.4W zener 3.6V E24 ±2%
<b>WT</b>	BCR166	Sie	N	SOT23	pnp dig 50V 0.1A 4k7+47k
<b>WT</b>	BCR166W	Sie	N	SOT323	pnp dig 50V 0.1A 4k7+47k
<b>WT</b>	BCR48PN	Sie	DP	SOT363	pnp/npn dig npn 2x47k pnp 2k2+47k
<b>WT</b>	BZX284-B3V9	Phi	I	SOD110	0.4W zener 3.9V E24 ±2%
<b>WU</b>	BCR162	Sie	N	SOT23	pnp dig 50V 0.1A 4k7+4k7
<b>WU</b>	BCR162T	Sie	N	SC75	pnp dig 50V 0.1A 4k7+4k7
<b>WU</b>	BCR35PN	Sie	DP	SOT363	pnp/npn dig 0.1A 10k+47k
<b>WU</b>	BZX284-B4V3	Phi	I	SOD110	0.4W zener 4.3V E24 ±2%
<b>WU</b>	MRF2947A	Mot	DG	SOT363	dual MRF941 npn RF 9GHz

### Codes beginning with 'X'

Code	Device	Manufacturer	Base	Package	Leaded Equivalent/Data
<b>X (white)</b>	BB833	Sie	I	SOT323	9.3-0.75pF varicap
<b>X (yellow)</b>	BB835	Sie	I	SOT323	9.1-0.6pF varicap
<b>X1</b>	BFT93	Sie	N	SOT23	BFQ23 BFQ75
<b>X1p</b>	BFT93	Phi	N	SOT23	BFQ23 BFQ75
<b>X1</b>	IMX1	Roh	DC	-	dual 2SC2412K npn
<b>X1</b>	BZX84-C27	Phi	C	SOT23	0.3W zener 27V±5%
<b>X2</b>	IMX2	Roh	DD	-	dual 2SC2412K npn

X2	BZX99-C13	Phi	C	SOT23	13V 0.3W zener ±5%
X2	BZX84-C30	Zet	C	SOT23	0.3W zener 30V±5%
X2	BZV49C30	Zet	O	SOT89	1W zener 30V±5%
X3	BZX99-C15	Phi	C	SOT23	15V 0.3W zener ±5%
X3	BZX84-C33	Zet	C	SOT23	0.3W zener 33V±5%
X4	BFT93R	Sie	R	SOT23R	BFQ23 BFQ75
X4	BZX84-C36	Zet	C	SOT23	0.3W zener 36V±5%
X5	BZV49C39	Zet	O	SOT89	1W zener 39V±5%
X5	MMBV409G	Mot	C	SOT23	Hyperabrupt varicap
X6	BZV49C43	Zet	O	SOT89	1W zener 43V±5%
X6	BZX84-C43	Zet	C	SOT23	0.3W zener 43V±5%
X7	BZX84-C47	Zet	C	SOT23	0.3W zener 47V±5%
XAs	BCR503	Sie	N	SOT23	npn dtr 50V 0.5A 2k2 +2k2
XA	BZX284-B7V5	Phi	I	SOD110	0.4W zener 7.5V E24 ±2%
XA	BZX99-C4V7	Phi	C	SOT23	4.7V 0.3W zener
XBs	BCR553	Sie	N	SOT23	npn dtr 50V 0.5A 2k2 +2k2
XB	BZX284-B8V2	Phi	I	SOD110	0.4W zener 8.2V E24 ±2%
XB	BZX99-C5V1	Phi	C	SOT23	5.1V 0.3W zener
XCs	BCR533	Sie	N	SOT23	npn dtr 50V 0.5A 10k + 10k
XC	BZX284-B9V1	Phi	I	SOD110	0.4W zener 9.1V E24 ±2%
XC	BZX99-C5V6	Phi	C	SOT23	5.6V 0.3W zener
XD <sub>s</sub>	BCR555	Sie	N	SOT23	npn dtr 50V 0.5A 2k2 +10k
XD	BZX284-B10	Phi	I	SOD110	0.4W zener 10V E24 ±2%
XD	BZX99-C6V2	Phi	C	SOT23	6.2V 0.3W zener
XE	BZX284-B11	Phi	I	SOD110	0.4W zener 11V E24 ±2%
XE	BZX99-C6V8	Phi	C	SOT23	6.8V 0.3W zener
XF <sub>s</sub>	BCR512	Sie	N	SOT23	npn dtr 50V 0.5A 4k7+ 4k7
XF	BZX284-B12	Phi	I	SOD110	0.4W zener 12V E24 ±2%
XG <sub>s</sub>	BCR523	Sie	N	SOT23	npn dtr 50V 0.5A 1k0 +10k
XG	BZX284-B13	Phi	I	SOD110	0.4W zener 13V E24 ±2% S
XH <sub>s</sub>	BCR573	Sie	N	SOT23	npn dtr 50V 0.5A 1k0 +10k
XH	BZX284-B15	Phi	I	SOD110	0.4W zener 15V E24 ±2%
XH	MMSD701	Mot	I	SOD123	MMBD701
XI	BZX284-B16	Phi	I	SOD110	0.4W zener 16V E24 ±2%
XJ	BZX284-B18	Phi	I	SOD110	0.4W zener 18V E24 ±2%
XK <sub>s</sub>	BCR519	Sie	N	SOT23	npn dtr 50V 0.5A R1 4k7
XK	BZX284-B20	Phi	I	SOD110	0.4W zener 20V E24 ±2%
XL <sub>s</sub>	BCR569	Sie	N	SOT23	npn dtr 50V 0.5A R1 4k7
XL	BZX284-B22	Phi	I	SOD110	0.4W zener 22V E24 ±2%
XL	BZX99-C2V4	Phi	C	SOT23	2.4V 0.3W zener
XM <sub>s</sub>	BCR583	Sie	N	SOT23	npn dtr 50V 0.5A 10k +10k
XM	BZX284-B24	Phi	I	SOD110	0.4W zener 24V E24 ±2%
XM	BZX99-C2V7	Phi	C	SOT23	2.7V 0.3W zener
XN	BZX284-B27	Phi	I	SOD110	0.4W zener 27V E24 ±2%
XN	BZX99-C3V0	Phi	C	SOT23	3.0V 0.3W zener
XO	BZX284-B30	Phi	I	SOD110	0.4W zener 30V E24 ±2%
XP	MMBD3000	Mot	C	SOT346	Si diode 30V 0.2A
XP	BZX284-B33	Phi	I	SOD110	0.4W zener 33V E24 ±2%
XP	BZX99-C3V3	Phi	C	SOT23	3.3V 0.3W zener
XQ	MMBD3005	Mot	A	SOT346	dual ca MMBD3000
XQ	BZX284-B36	Phi	I	SOD110	0.4W zener 36V E24 ±2%
XQ	2PD602AQ	Phi	N	SOT346	gp npn hfe 85-170
XR	BZX284-B39	Phi	I	SOD110	0.4W zener 39V E24 ±2%
XR	BZX99-C3V6	Phi	C	SOT23	3.6V 0.3W zener
XR	MRF2947RA	Mot	DH	SOT363	dual MRF941 npn RF 9GHz
XR	2PD602AR	Phi	N	SOT346	gp npn hfe 120-240
XS	MMBD3010	Mot	B	SOT346	dual cc MMBD3000
XS	BZX284-B43	Phi	I	SOD110	0.4W zener 43V E24 ±2%
XS	BZX99-C3V9	Phi	C	SOT23	3.9V 0.3W zener
XS	2PD602AS	Phi	N	SOT346	gp npn hfe 170-340
XT	BZX284-B47	Phi	I	SOD110	0.4W zener 47V E24 ±2%
XT	MMSD301	Mot	I	SOD123	MBD301
XT	BZX99-C4V3	Phi	C	SOT23	4.3V 0.3W zener
XU	BZX284-B51	Phi	I	SOD110	0.4W zener 51V E24 ±2%
XU	MRF2947RA	Mot	DH	-	dual MRF941 npn RF 9GHz

<b>XUs</b>	BCR562	Sie	N	SOT23	pnp dtr 50V 0.5A 4k7+ 4k7
<b>XU</b>	BZX99-C7V5	Phi	C	SOT23	7.5V 0.3W zener
<b>XV</b>	BZX284-B56	Phi	I	SOD110	0.4W zener 56V E24 ±2%
<b>XVs</b>	BCR521	Sie	N	SOT23	npn dtr 50V 0.5A 1k0 +1k0
<b>XV</b>	BZX99-C8V2	Phi	C	SOT23	8.2V 0.3W zener
<b>XW</b>	BZX284-B62	Phi	I	SOD110	0.4W zener 62V E24 ±2%
<b>XWs</b>	BCR505	Sie	N	SOT23	npn dtr 50V 0.5A 2k2 +10k
<b>XW</b>	BZX99-C9V1	Phi	C	SOT23	9.1V 0.3W zener
<b>XX</b>	BZX284-B68	Phi	I	SOD110	0.4W zener 68V E24 ±2%
<b>XX</b>	BZX99-C10	Phi	C	SOT23	10V 0.3W zener
<b>XXs</b>	BCR571	Sie	N	SOT23	pnp dtr 50V 0.5A 1k0 +1k0
<b>XY</b>	BZX99-C11	Phi	C	SOT23	11V 0.3W zener
<b>XY</b>	BZX284-B75	Phi	I	SOD110	0.4W zener 75V E24 ±2%
<b>XZ</b>	BZX99-C12	Phi	C	SOT23	12V 0.3W zener

### Codes beginning with 'Y'

Code	Device	Manufacturer	Base	Package	Leaded Equivalent/Data
<b>Y0s</b>	CGY121B	Sie	-	-	GaAs MMIC
<b>Y1</b>	BZX84-C11	Phi	C	SOT23	0.3W zener 11V±5%
<b>Y1p</b>	BZX84-C11	Phi	C	SOT23	0.3W zener 11V±5%
<b>Y1</b>	BZV49C11	Zet	O	SOT89	1W zener 11V ±5%
<b>Y2</b>	CLY2	Sie	DR	MW6	3GHz GaAsfet 0.25W 3GHz
<b>Y2</b>	BZX84-C12	Phi	C	SOT23	0.3W zener 12V±5%
<b>Y3</b>	BZX84-C13	Phi	C	SOT23	0.3W zener 13V±5%
<b>Y4</b>	BZX84-C15	Phi	C	SOT23	0.3W zener 15V±5%
<b>Y4</b>	BZV49C15	Zet	O	SOT89	1W zener 15V ±5%
<b>Y5s</b>	CGY59	Sie	DS	SOT363	GaAs 0.9/1.8GHz preamp
<b>Y5</b>	BZX84-C16	Phi	C	SOT23	0.3W zener 16V±5%
<b>Y5</b>	BZV49C16	Zet	O	SOT89	1W zener 16V ±5%
<b>Y6s</b>	CGY62	Sie	DS	MW6	GaAs MMIC
<b>Y6</b>	BZX84-C18	Phi	C	SOT23	0.3W zener 18V±5%
<b>Y7</b>	CGY60	Sie	DS	MW6	GaAs preamp MMIC 1.8GHz
<b>Y7</b>	BZX84-C20	Phi	C	SOT23	0.3W zener 20V±5%
<b>Y8</b>	CGY120	Sie	-	MW6	GaAs MMIC
<b>Y8</b>	BZX84-C22	Phi	C	SOT23	0.3W zener 22V±5%
<b>Y8</b>	BZV49C22	Zet	O	SOT89	1W zener 22V ±5%
<b>Y9s</b>	CGY121A	Sie	-	MW6	GaAs MMIC
<b>Y9</b>	BZX84-C24	Phi	C	SOT23	0.3W zener 24V±5%
<b>Y9</b>	BZV49C24	Zet	O	SOT89	1W zener 24V ±5%
<b>Y10</b>	BZX84-C27	Phi	C	SOT23	0.3W zener 27V±5%
<b>Y11</b>	BZX84-C30	Phi	C	SOT23	0.3W zener 30V±5%
<b>Y12</b>	BZX84-C33	Phi	C	SOT23	0.3W zener 33V±5%
<b>Y13</b>	BZX84-C36	Phi	C	SOT23	0.3W zener 36V±5%
<b>Y14</b>	BZX84-C39	Phi	C	SOT23	0.3W zener 39V±5%
<b>Y15</b>	BZX84-C43	Phi	C	SOT23	0.3W zener 43V±5%
<b>Y16</b>	BZX84-C47	Phi	C	SOT23	0.3W zener 47V±5%
<b>Y17</b>	BZX84-C51	Phi	C	SOT23	0.3W zener 51V±5%
<b>Y18</b>	BZX84-C56	Phi	C	SOT23	0.3W zener 56V±5%
<b>Y19</b>	BZX84-C62	Phi	C	SOT23	0.3W zener 62V±5%
<b>Y20</b>	BZX84-C68	Phi	C	SOT23	0.3W zener 68V±5%
<b>Y21</b>	BZX84-C75	Phi	C	SOT23	0.3W zener 75V±5%
<b>Y36</b>	BZX84-C13V6	Phi	C	SOT23	0.3W zener 13.6V±5%
<b>Y50</b>	BZX84-A2V4	Phi	C	SOT23	0.3W zener 2.4V ±1%
<b>Y51</b>	BZX84-A2V7	Phi	C	SOT23	0.3W zener 2.7V ±1%
<b>Y52</b>	BZX84-A3V0	Phi	C	SOT23	0.3W zener 3.0V ±1%
<b>Y53</b>	BZX84-A3V3	Phi	C	SOT23	0.3W zener 3.3V ±1%
<b>Y54</b>	BZX84-A3V6	Phi	C	SOT23	0.3W zener 3.6V ±1%
<b>Y55</b>	BZX84-A3V9	Phi	C	SOT23	0.3W zener 3.9V ±1%
<b>Y56</b>	BZX84-A4V3	Phi	C	SOT23	0.3W zener 4.3V ±1%
<b>Y57</b>	BZX84-A4V7	Phi	C	SOT23	0.3W zener 4.7V ±1%
<b>Y58</b>	BZX84-A5V1	Phi	C	SOT23	0.3W zener 5.1V ±1%
<b>Y59</b>	BZX84-A5V6	Phi	C	SOT23	0.3W zener 5.6V ±1%
<b>Y60</b>	BZX84-A6V2	Phi	C	SOT23	0.3W zener 6.2V ±1%

Y61	BZX84-A6V8	Phi	C	SOT23	0.3W zener 6.8V ±1%
Y62	BZX84-A7V5	Phi	C	SOT23	0.3W zener 7.5V ±1%
Y63	BZX84-A8V2	Phi	C	SOT23	0.3W zener 8.2V ±1%
Y64	BZX84-A9V1	Phi	C	SOT23	0.3W zener 9.1V ±1%
Y65	BZX84-A10	Phi	C	SOT23	0.3W zener 10V ±1%
Y66	BZX84-A11	Phi	C	SOT23	0.3W zener 11V ±1%
Y67	BZX84-A12	Phi	C	SOT23	0.3W zener 12V ±1%
Y68	BZX84-A13	Phi	C	SOT23	0.3W zener 13V ±1%
Y69	BZX84-A15	Phi	C	SOT23	0.3W zener 15V ±1%
Y70	BZX84-A16	Phi	C	SOT23	0.3W zener 16V ±1%
Y71	BZX84-A18	Phi	C	SOT23	0.3W zener 18V ±1%
Y72	BZX84-A20	Phi	C	SOT23	0.3W zener 20V ±1%
Y73	BZX84-A22	Phi	C	SOT23	0.3W zener 22V ±1%
Y74	BZX84-A24	Phi	C	SOT23	0.3W zener 24V ±1%
Y75	BZX84-A27	Phi	C	SOT23	0.3W zener 27V ±1%
Y76	BZX84-A30	Phi	C	SOT23	0.3W zener 30V ±1%
Y77	BZX84-A33	Phi	C	SOT23	0.3W zener 33V ±1%
Y78	BZX84-A36	Phi	C	SOT23	0.3W zener 36V ±1%
Y79	BZX84-A39	Phi	C	SOT23	0.3W zener 39V ±1%
Y80	BZX84-A43	Phi	C	SOT23	0.3W zener 43V ±1%
Y81	BZX84-A47	Phi	C	SOT23	0.3W zener 47V ±1%
Y82	BZX84-A51	Phi	C	SOT23	0.3W zener 51V ±1%
Y83	BZX84-A56	Phi	C	SOT23	0.3W zener 56V ±1%
Y84	BZX84-A62	Phi	C	SOT23	0.3W zener 62V ±1%
Y85	BZX84-A68	Phi	C	SOT23	0.3W zener 68V ±1%
Y86	BZX84-A75	Phi	C	SOT23	0.3W zener 75V ±1%
YBs	BSS84	Inf	M	SOT23	p-ch mosfet 50V 0.13A
YO	BZX284-C2V4	Phi	I	SOD110	0.4W zener 2.4V E12 ±5%
YP	BZX284-C2V7	Phi	I	SOD110	0.4W zener 2.7V E12 ±5%
YQ	BZX284-C3V0	Phi	I	SOD110	0.4W zener 3.0V E12 ±5%
YR	MSD601R	Mot	N	SOT346	npn gp 25V
YR	BZX284-C3V3	Phi	I	SOD110	0.4W zener 3.3V E12 ±5%
YS	MSD601S	Mot	N	SOT346	npn gp 25V
YS	BZX284-C3V6	Phi	I	SOD110	0.4W zener 3.6V E12 ±5%
YT	BZX284-C3V9	Phi	I	SOD110	0.4W zener 3.9V E12 ±5%
YU	BZX284-C4V3	Phi	I	SOD110	0.4W zener 4.3V E12 ±5%
YV	BZX284-C4V7	Phi	I	SOD110	0.4W zener 4.7V E12 ±5%
YW	BZX284-C5V1	Phi	I	SOD110	0.4W zener 5.1V E12 ±5%
YX	BZX284-C5V6	Phi	I	SOD110	0.4W zener 5.6V E12 ±5%
YY	BZX284-C6V2	Phi	I	SOD110	0.4W zener 6.2V E12 ±5%
YZ	BZX284-C6V8	Phi	I	SOD110	0.4W zener 6.8V E12 ±5%

### Codes beginning with 'Z'

Code	Device	Manufacturer	Base	Package	Leaded Equivalent/Data
Z0	SST310	Tem	F	SOT23	J310 n-ch jfet
Z0	PDZ2.4B	Phi	I	SOD323	2.4V 0.4W zener
Z08	SST308	Sil	F	SOT23	J308 n-ch jfet
Z09	SST309	Sil	F	SOT23	J309 n-ch jfet
Z10	SST310	Sil	F	SOT23	J310 n-ch jfet
Z1	BZX84-C4V7	Phi	C	SOT23	0.3W zener 4.7V
Z1	SSTJ211	Sil	F	SOT23	J211 n-ch jfet
Z1	PDZ2.7B	Phi	I	SOD323	2.7V 0.4W zener
Z1	IMZ1A	Roh	DE	-	2SC2414 npn,2SA1037AK pnp
Z1	BZV49C4V7	Zet	O	SOT89	1W ±5% zener 4.7V
Z2	BZX84-C5V1	Phi	C	SOT23	0.3W zener 4.7V
Z2	SSTJ212	Sil	F	SOT23	J212 n-ch jfet
Z2	IMZ2A	Roh	DF	-	2SC2414 npn,2SA1037AK pnp
Z2	PDZ3.0B	Phi	I	SOD323	3.0V 0.4W zener
Z2	BZV49C5V1	Zet	O	SOT89	1W ±5% zener 5.1V
Z2U	FMMTA63	Zet	N	SOT23	MPSA63
Z2V	FMMTA64	Zet	N	SOT23	MPSA64
Z3	BZX84-C5V6	Phi	C	SOT23	0.3W zener 5.6V



Z3	PDZ3.3B	Phi	I	SOD323	3.3V 0.4W zener
Z3	2SK1078	Tos	T	SOT89	n-ch mosfet 60V 0.8A
Z3	BZV49C5V6	Zet	O	SOT89	1W ±5% zener 5.6V
Z4	BZX84-C6V2	Phi	C	SOT23	0.3W zener 6.2V
Z4	PDZ3.6B	Phi	I	SOD323	3.6V 0.4W zener
Z4	2SK1079	Tos	T	SOT89	n-ch mosfet 100V 0.6A
Z4	BZV49C6V2	Zet	O	SOT89	1W ±5% zener 6.2V
Z5	BZX84-C6V8	Phi	C	SOT23	0.3W zener 6.8V
Z5	PDZ3.9B	Phi	I	SOD323	3.9V 0.4W zener
Z5	2SK1717	Tos	T	SOT89	n-ch mosfet 60V 2A
Z5	BZV49C6V8	Zet	O	SOT89	1W ±5% zener 6.8V
Z6	BZX84-C7V5	Phi	C	SOT23	0.3W zener 7.5V
Z6	PDZ4.3B	Phi	I	SOD323	4.3V 0.4W zener
Z6	2SJ238	Tos	T	SOT89	p-ch mosfet 60V 1A
Z6	BZV49C7V5	Zet	O	SOT89	1W ±5% zener 7.5V
Z7	BZX84-C8V2	Phi	C	SOT23	0.3W zener 8.2V
Z7	PDZ4.7B	Phi	I	SOD323	4.7V 0.4W zener
Z7	BZV49C8V2	Zet	O	SOT89	1W ±5% zener 8.2V
Z8	BZX84-C9V1	Phi	C	SOT23	0.3W zener 9.1V
Z8	PDZ5.1B	Phi	I	SOD323	5.1V 0.4W zener
Z8	BZV49C9V1	Zet	O	SOT89	1W ±5% zener 9.1V
Z9	BZX84-C10	Phi	C	SOT23	0.3W zener 10V
Z9	PDZ5.6B	Phi	I	SOD323	5.6V 0.4W zener
Z1	BZV49C10	Zet	O	SOT89	1W ±5% zener 10V
Z10	SST310	Sil	F	SOT23	J310 n-ch jfet
Z11	BZX84-C2V4	Phi	C	SOT23	0.3W zener 2.4V ±5%
Z12	BZX84-C2V7	Phi	C	SOT23	0.3W zener 2.7V ±5%
Z13	BZX84-C3V0	Phi	C	SOT23	0.3W zener 3.0V ±5%
Z14	BZX84-C3V3	Phi	C	SOT23	0.3W zener 3.3V ±5%
Z15	BZX84-C3V6	Phi	C	SOT23	0.3W zener 3.6V ±5%
Z16	BZX84-C3V9	Phi	C	SOT23	0.3W zener 3.9V ±5%
Z17	BZX84-C4V3	Phi	C	SOT23	0.3W zener 4.3V ±5%
Z21	DTC113ZE	Rho	N	EMT3	npn dtr 1k0 + 10k 50V 100mA
Z21	DTC113ZUA	Rho	N	SC70	npn dtr 1k0 + 10k 50V 100mA
Z21	DTC113ZKA	Rho	N	SC59	npn dtr 1k0 + 10k 50V 100mA
Z50	BZX84-B2V4	Phi	C	SOT23	0.3W zener 2.4V ±2%
Z51	BZX84-B2V7	Phi	C	SOT23	0.3W zener 2.7V ±2%
Z52	BZX84-B3V0	Phi	C	SOT23	0.3W zener 3.0V ±2%
Z53	BZX84-B3V3	Phi	C	SOT23	0.3W zener 3.3V ±2%
Z54	BZX84-B3V6	Phi	C	SOT23	0.3W zener 3.6V ±2%
Z55	BZX84-B3V9	Phi	C	SOT23	0.3W zener 3.9V ±2%
Z56	BZX84-B4V3	Phi	C	SOT23	0.3W zener 4.3V ±2%
Z57	BZX84-B4V7	Phi	C	SOT23	0.3W zener 4.7V ±2%
Z58	BZX84-B5V1	Phi	C	SOT23	0.3W zener 5.1V ±2%
Z59	BZX84-B5V6	Phi	C	SOT23	0.3W zener 5.6V ±2%
Z60	BZX84-B6V2	Phi	C	SOT23	0.3W zener 6.2V ±2%
Z61	BZX84-B6V8	Phi	C	SOT23	0.3W zener 6.8V ±2%
Z62	BZX84-B7V5	Phi	C	SOT23	0.3W zener 7.5V ±2%
Z63	BZX84-B8V2	Phi	C	SOT23	0.3W zener 8.2V ±2%
Z64	BZX84-B9V1	Phi	C	SOT23	0.3W zener 9.1V ±2%
Z65	BZX84-B10	Phi	C	SOT23	0.3W zener 10V ±2%
Z66	BZX84-B11	Phi	C	SOT23	0.3W zener 11V ±2%
Z67	BZX84-B12	Phi	C	SOT23	0.3W zener 12V ±2%
Z68	BZX84-B13	Phi	C	SOT23	0.3W zener 13V ±2%
Z69	BZX84-B15	Phi	C	SOT23	0.3W zener 15V ±2%
Z70	BZX84-B16	Phi	C	SOT23	0.3W zener 16V ±2%
Z71	BZX84-B18	Phi	C	SOT23	0.3W zener 18V ±2%
Z72	BZX84-B20	Phi	C	SOT23	0.3W zener 20V ±2%
Z73	BZX84-B22	Phi	C	SOT23	0.3W zener 22V ±2%
Z74	BZX84-B24	Phi	C	SOT23	0.3W zener 24V ±2%
Z75	BZX84-B27	Phi	C	SOT23	0.3W zener 27V ±2%
Z76	BZX84-B30	Phi	C	SOT23	0.3W zener 30V ±2%
Z77	BZX84-B33	Phi	C	SOT23	0.3W zener 33V ±2%
Z78	BZX84-B36	Phi	C	SOT23	0.3W zener 36V ±2%
Z79	BZX84-B39	Phi	C	SOT23	0.3W zener 39V ±2%

Z80	BZX84-B43	Phi	C	SOT23	0.3W zener 43V ±2%
Z81	BZX84-B47	Phi	C	SOT23	0.3W zener 47V ±2%
Z82	BZX84-B51	Phi	C	SOT23	0.3W zener 51V ±2%
Z83	BZX84-B56	Phi	C	SOT23	0.3W zener 56V ±2%
Z84	BZX84-B62	Phi	C	SOT23	0.3W zener 62V ±2%
Z85	BZX84-B68	Phi	C	SOT23	0.3W zener 68V ±2%
Z86	BZX84-B75	Phi	C	SOT23	0.3W zener 75V ±2%
ZA	BZX284-C7V5	Phi	I	SOD110	0.4W zener 7.5V ±5%
ZA	PDZ6.2B	Phi	I	SOD323	6.2V 0.4W zener
ZB	FMMT4123	Zet	N	SOT23	2N4123
ZB	PDZ6.8B	Phi	I	SOD323	6.8V 0.4W zener
ZB	BZX284-C8V2	Phi	I	SOD110	0.4W zener 8.2V ±5%
ZC	FMMT4124	Zet	N	SOT23	2N4124
ZC	BZX284-C9V1	Phi	I	SOD110	0.4W zener 9.1V ±5%
ZC	PDZ7.5B	Phi	I	SOD323	7.5V 0.4W zener
ZD	FMMT4125	Zet	N	SOT23	2N4125
ZD	MMBT4125	Mot	N	SOT23	2N4125
ZD	BZX284-C10	Phi	I	SOD110	0.4W zener 10V ±5%
ZD	PDZ8.2B	Phi	I	SOD323	8.2V 0.4W zener
ZE	FMMT4126	Zet	N	SOT23	2N4126
ZE	MMBT4123	Nat	N	SOT23	2N4123
ZE	BZX284-C11	Phi	I	SOD110	0.4W zener 11V ±5%
ZE	PDZ9.1B	Phi	I	SOD323	9.1V 0.4W zener
ZF	BZX284-C12	Phi	I	SOD110	0.4W zener 12V ±5%
ZF	PDZ10B	Phi	I	SOD323	10V 0.4W zener
ZG	BZX284-C13	Phi	I	SOD110	0.4W zener 13V ±5%
ZG	PDZ11B	Phi	I	SOD323	11V 0.4W zener
ZH	BZX284-C15	Phi	I	SOD110	0.4W zener 15V ±5%
ZH	PDZ12B	Phi	I	SOD323	12V 0.4W zener
ZHK	SM2Z5V1	STM	I	2W SMD	5.1V 2W zener
ZHL	SM2Z5V6	STM	I	2W SMD	5.6V 2W zener
ZHW	SM2Z12	STM	I	2W SMD	12V 2W zener
ZI	BZX284-C16	Phi	I	SOD110	0.4W zener 16V ±5%
ZJ	BZX284-C18	Phi	I	SOD110	0.4W zener 18V ±5%
ZJ	PDZ13B	Phi	I	SOD323	13V 0.4W zener
ZJF	SM2Z18	STM	I	2W SMD	18V 2W zener
ZJQ	SM2Z30	STM	I	2W SMD	30V 2W zener
ZK	BZX284-C20	Phi	I	SOD110	0.4W zener 20V ±5%
ZK	PDZ15B	Phi	I	SOD323	15V 0.4W zener
ZKR	SM2Z150	STM	I	2W SMD	150V 2W zener
ZL	BZX284-C22	Phi	I	SOD110	0.4W zener 22V ±5%
ZL	PDZ16B	Phi	I	SOD323	16V 0.4W zener
ZM	BZX284-C24	Phi	I	SOD110	0.4W zener 24V ±5%
ZM	PDZ18B	Phi	I	SOD323	18V 0.4W zener
ZN	BZX284-C27	Phi	I	SOD110	0.4W zener 27V ±5%
ZN	PDZ20B	Phi	I	SOD323	20V 0.4W zener
ZO	BZX284-C30	Phi	I	SOD110	0.4W zener 30V ±5%
ZP	BZX284-C33	Phi	I	SOD100	0.4W zener 33V ±5%
ZP	PDZ22B	Phi	I	SOD323	22V 0.4W zener
ZQ	BZX284-C36	Phi	I	SOD110	0.4W zener 36V ±5%
ZQ	PDZ24B	Phi	I	SOD323	24V 0.4W zener
Z-Q	2PC4081Q	Phi	N	SOT323	gp npn hfe 120-270
ZtQ	2PC4081Q	Phi	N	SOT323	gp npn hfe 120-270
ZR	MSD1819A	Mot	N	SOT323	nnp gp 50V
ZR	BZX284-C39	Phi	I	SOD110	0.4W zener 39V ±5%
ZR	PDZ27B	Phi	I	SOD323	27V 0.4W zener
Z-R	2PC4081R	Phi	N	SOT323	gp npn hfe 180-390
ZtR	2PC4081R	Phi	N	SOT323	gp npn hfe 180-390
ZS	BZX284-C43	Phi	I	SOD110	0.4W zener 43V ±5%
ZS	PDZ30B	Phi	I	SOD323	30V 0.4W zener
ZS1	ZHCS1000	Zet	E	SOT23	30V 1A schottky diode
ZS5	ZHCS500	Zet	E	SOT23	40V 0.5A schottky diode
ZS7	ZHCS750	Zet	E	SOT23	30V 0.75A schottky diode
Z-S	2PC4081S	Phi	N	SOT323	gp npn hfe 270-560
ZtS	2PC4081S	Phi	N	SOT323	gp npn hfe 270-560

<b>ZT</b>	BZX284-C47	Phi	I	SOD110	0.4W zener 47V ±5%
<b>ZT</b>	PDZ33B	Phi	I	SOD323	33V 0.4W zener
<b>ZU</b>	BZX284-C51	Phi	I	SOD110	0.4W zener 51V ±5%
<b>ZU</b>	PDZ36B	Phi	I	SOD323	36V 0.4W zener
<b>ZV</b>	BZX284-C56	Phi	I	SOD110	0.4W zener 56V ±5%
<b>ZW</b>	BZX284-C62	Phi	I	SOD110	0.4W zener 62V ±5%
<b>ZX</b>	BZX284-C68	Phi	I	SOD110	0.4W zener 68V ±5%
<b>ZY</b>	BZX284-C75	Phi	I	SOD110	0.4W zener 75V ±5%
<b>ZS1</b>	ZHCS1000	Zet	C	SOT23	schottky 1A 30V
<b>ZS7</b>	ZHCS750	Zet	C	SOT23	schottky 0.75A 30V

## BASE PACKAGES

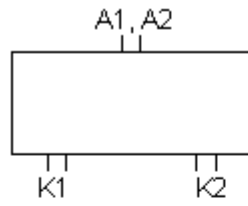
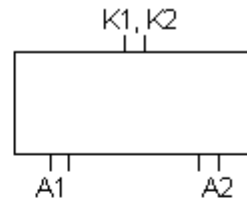
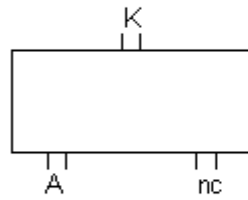
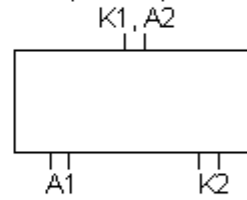
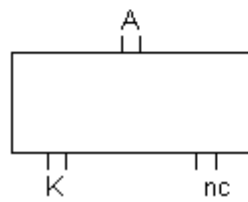
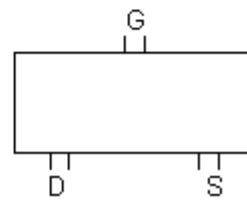
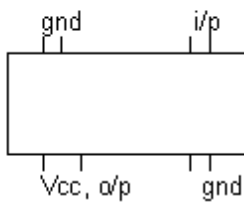
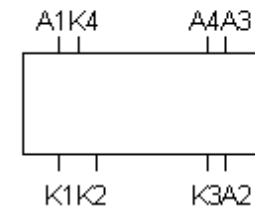
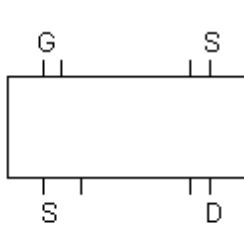
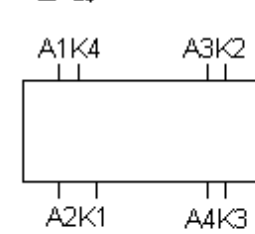
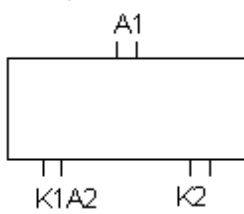
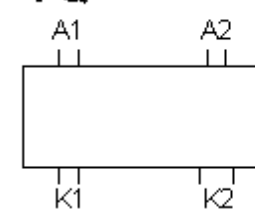
**A****B****C****D****E****F****AQ****BQ****CQ****DQ****EQ****FQ**

**CS**

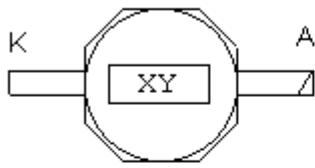

**CX**

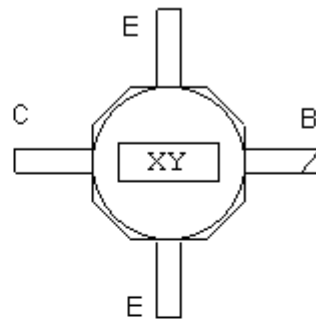

**CY**

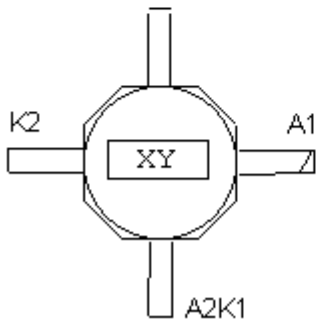

**CZ**

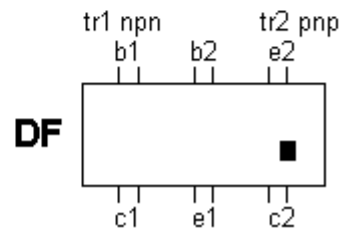
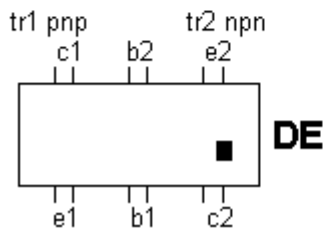
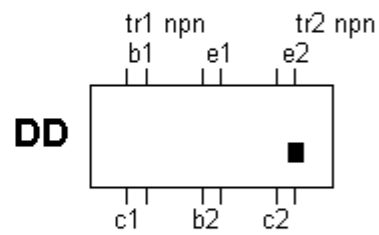
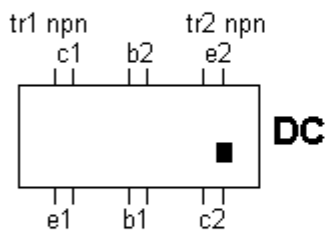
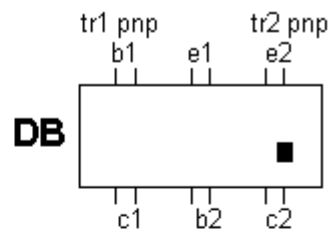
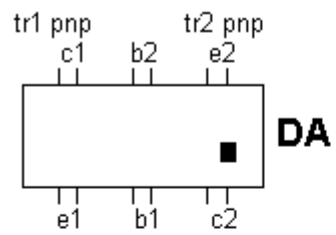
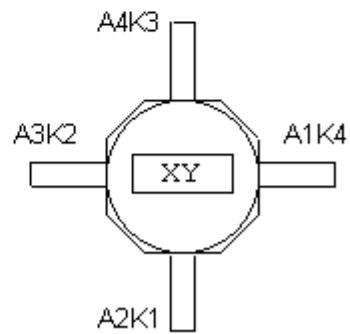

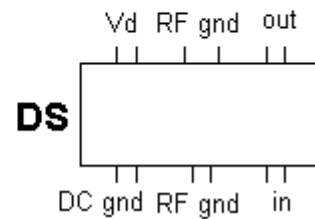
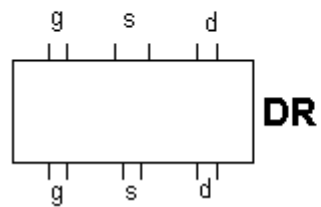
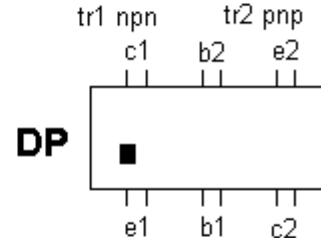
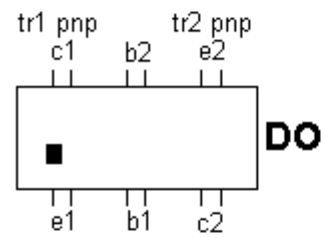
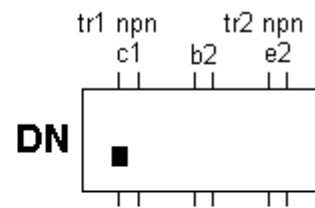
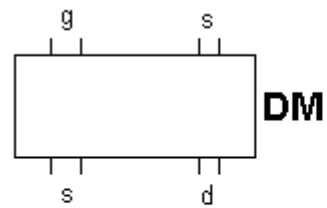
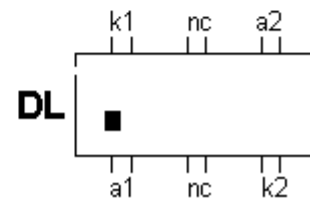
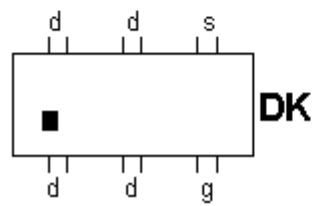
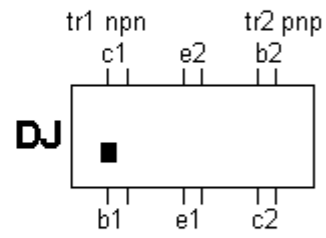
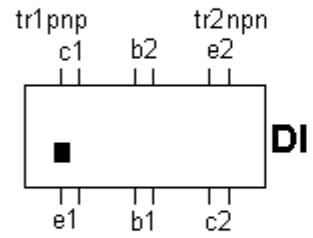
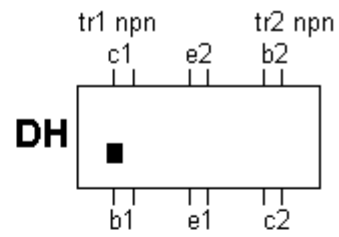
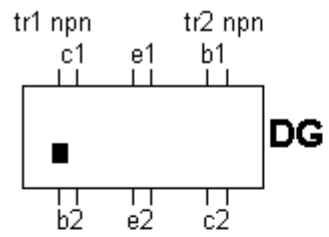

**G**

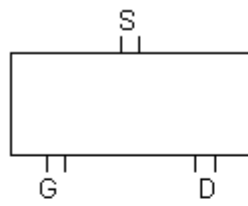

**H**

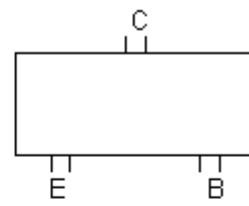

**I**

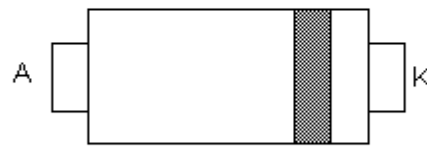

**J**

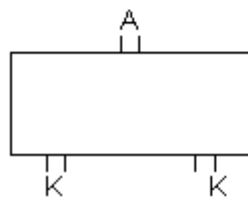

**K**

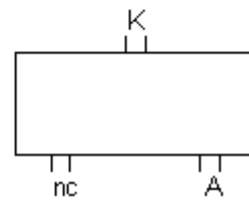

**GQ**

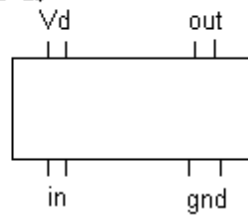

**HQ**

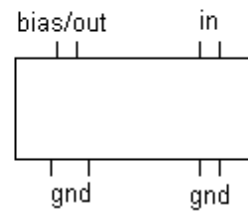

**IQ**

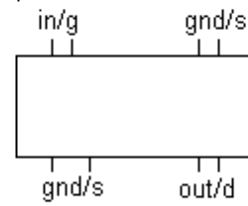

**JQ**

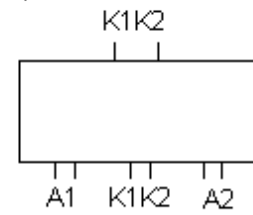

**LQ**

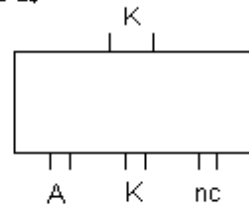

**(KQR)**

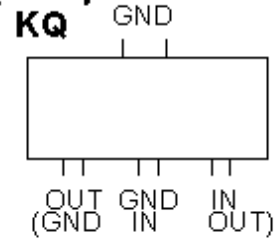

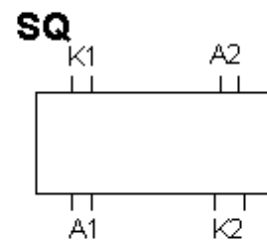
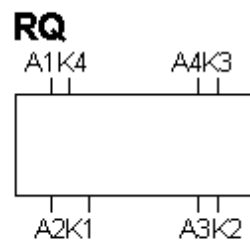
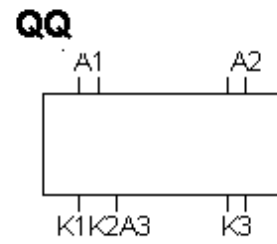
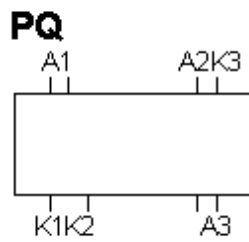
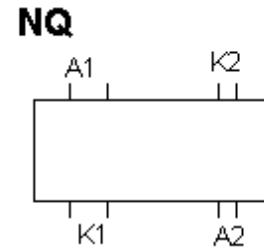
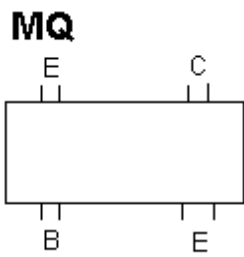
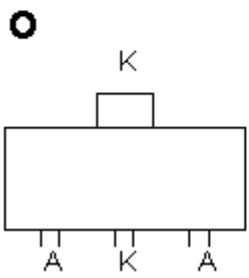
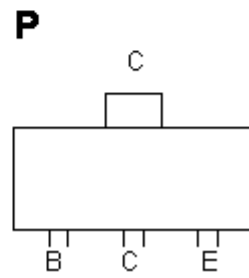
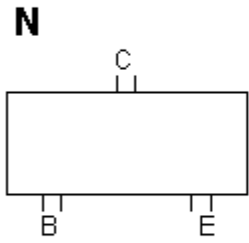
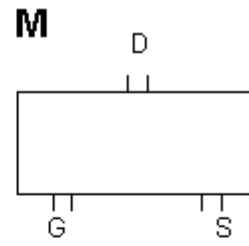
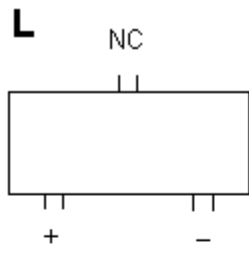



**Q**

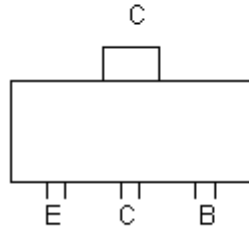

**R** (SOT-23 Reverse joggle)

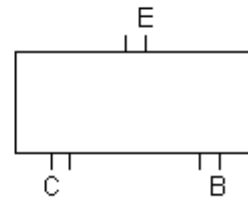

**S**

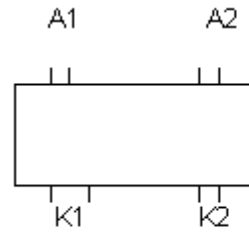

**T**

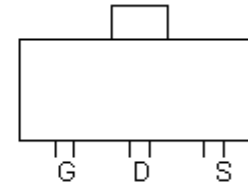

**U**

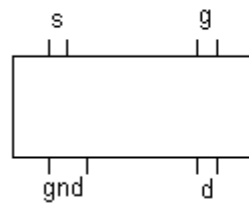

**V**

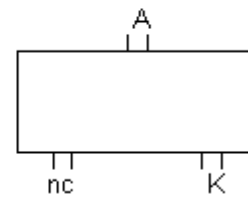

**TQ**

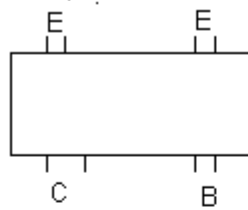

**UQ**

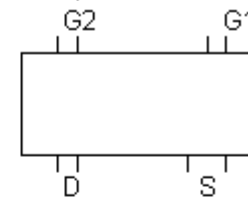

**VQ**

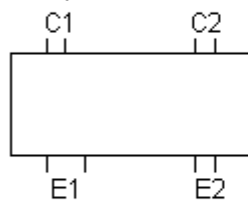

**WQ**

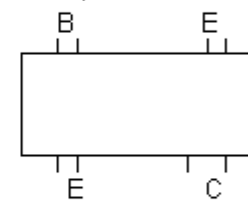

**XQ**

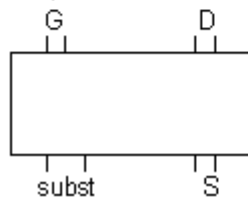

**ZQ**

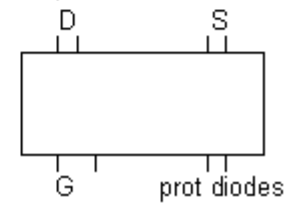

**W**

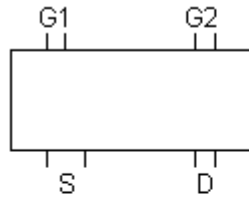

**X**

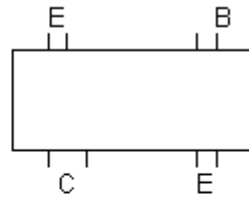

**Y**

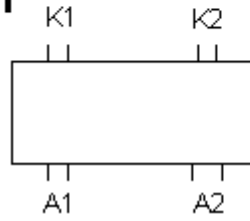

**Z**

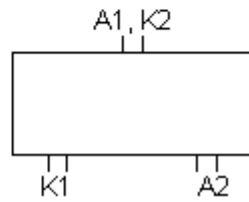

**ZA**

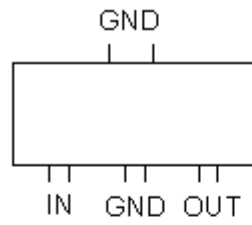

**ZB**

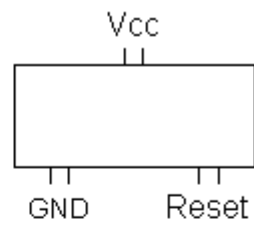

**ZC**

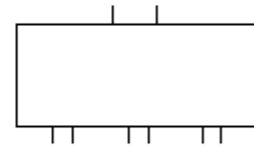
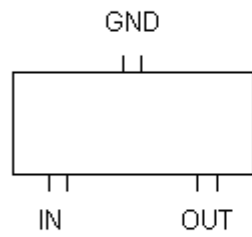

**ZF**

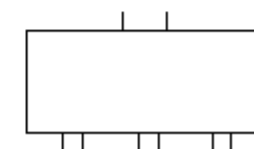
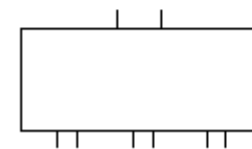

## PACKAGE EQUIVALENTS

Here is a table of more-or-less equivalents for many SMD packages.

Package	Equivalent
SOT89	SC62
SOT223	SC73
SOT323	SC70
SOT346	SC59
SOT363	SC88
SOT416	SC75 SC90
SOT457	SC74
SOD323	SC76

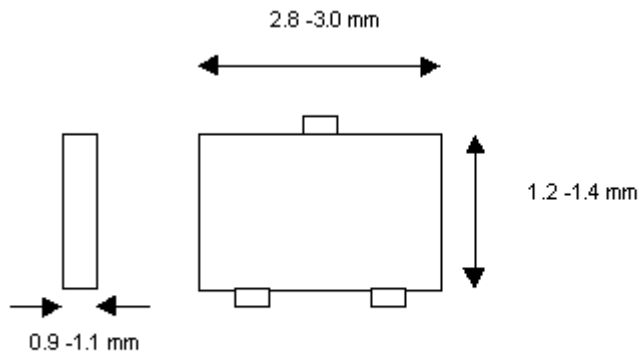

**SOT- 23**

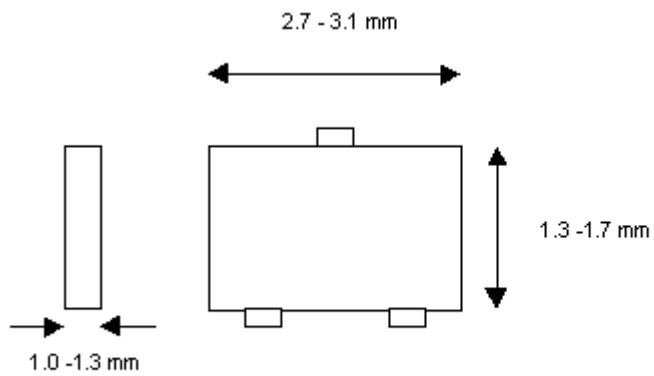

**SC- 59**

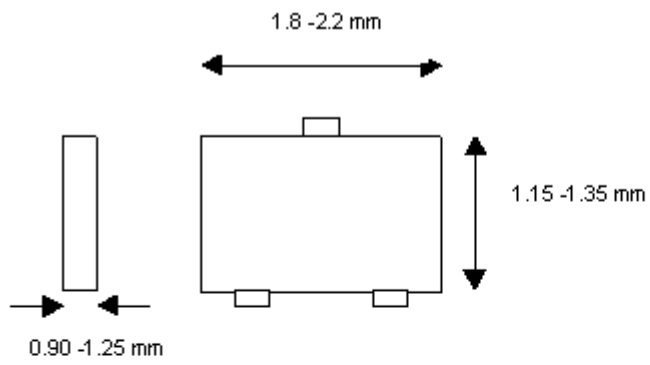

**SOT- 323/SC-70**

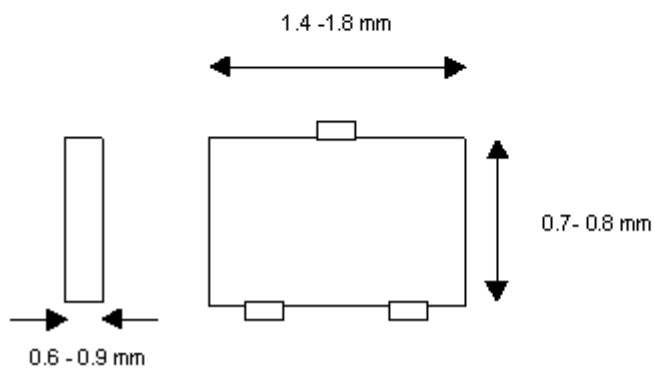

**SOT- 416/SC- 90**

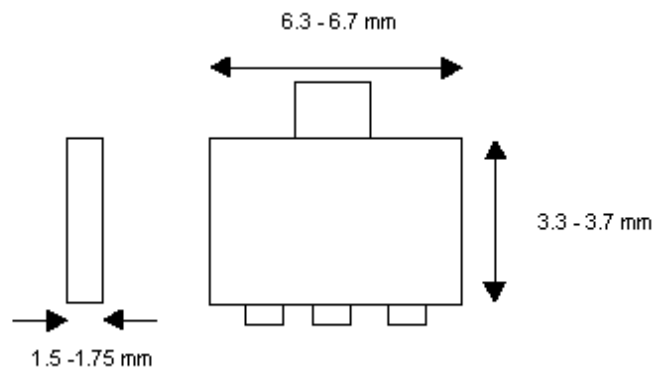

**SOT- 223**

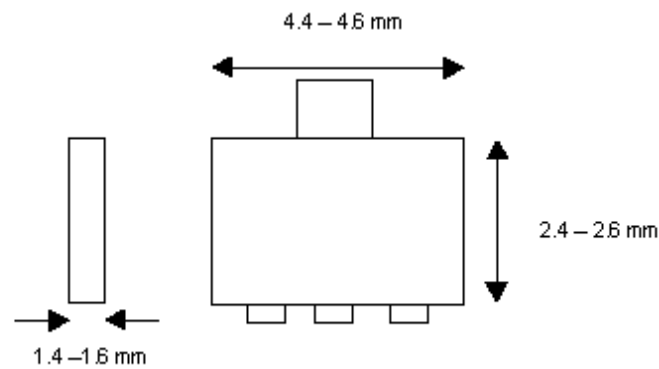

**SOT- 89**

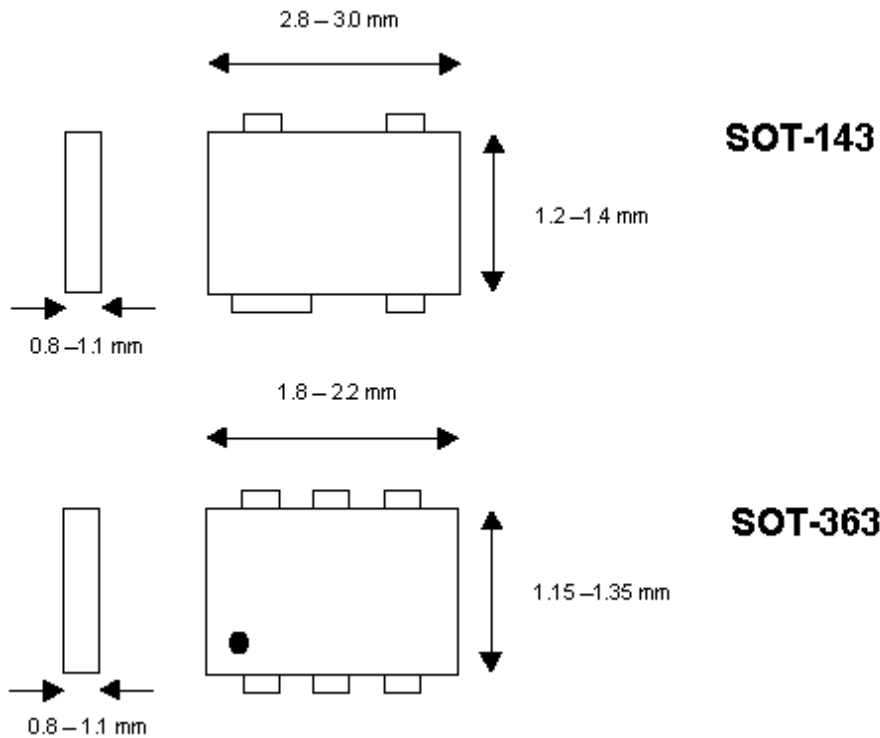

### SMD Ceramic Capacitor Coding

SMD ceramic capacitors are sometimes marked with a code, consisting of one or two letters and a digit. The first letter if present is a manufacturer code (i.e K for Kemet, etc.), the second letter the mantissa and the digit the exponent (multiplier) of the capacitance in pF. For example **S3** is a 4.7nF ( $4.7 \times 10^3$  pf) capacitor from an unknown manufacturer, while **KA2** is a 100 pF ( $1.0 \times 10^2$  pF) capacitor from Kemet. *Thanks to K7ITM for providing this information!*

Letter	Mantissa	Letter	Mantissa	Letter	Mantissa	Letter	Mantissa
A	1.0	J	2.2	S	4.7	a	2.5
B	1.1	K	2.4	T	5.1	b	3.5
C	1.2	L	2.7	U	5.6	d	4.0
D	1.3	M	3.0	V	6.2	e	4.5
E	1.5	N	3.3	W	6.8	f	5.0
F	1.6	P	3.6	X	7.5	m	6.0
G	1.8	Q	3.9	Y	8.2	n	7.0
H	2.0	R	4.3	Z	9.1	t	8.0
						y	9.0

### SMD Electrolytic Capacitor Coding

SMD electrolytic capacitors are often marked with their capacitance and working voltage, e.g. **10 6V** is 10  $\mu\text{F}$  6V . Sometimes a code is used instead, which normally consists of a letter and 3 digits. The letter indicates the working voltage and the 3 digits (2 digits and multiplier) give the capacitance in pF.

Letter	Voltage
e	2.5
G	4
J	6.3
A	10
C	16
D	20
E	25
V	35
H	50

The band or stripe indicates the positive terminal.

For example, a capacitor marked **A475** is a 4.7 $\mu\text{F}$  10V unit.

$$475 = 47 \times 10^5 \text{ pF} = 4.7 \times 10^6 \text{ pF} = 4.7\mu\text{F}$$

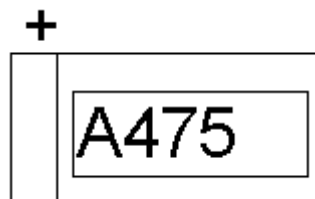

### SMD Resistor Coding

SMD Resistors are usually coded with a numerical equivalent of the familiar three band colour code. In the same way as wire ended components, precision resistors (1% or better) may be marked with a four digit code.

The first two (or 3) digits are the first two (or 3) digits of the resistance in ohms, and the third(or 4th) is the number of zeros to follow - the 'multiplier'.

Resistances of less than 10 ohms have a 'R' to indicate the position of the decimal point.

Some examples will meake this clearer:

#### Three Digit Examples

**330** is 33 ohms - *not 330 ohms*

**221** is 220 ohms

**683** is 68000 ohms, or 68 kohm

**105** is 1000000 ohms, or 1 Mohm

**8R2** is 8.2 ohms

#### Four Digit Examples

**1000** is 100 ohms - *not 1000 ohms*

**4992** is 49900 ohms, or 49.9 kohm

**16234** is 162000 ohms, or 162 kohm

**0R56** or **R56** is 0.56 ohms

### SOD-123 Package Diodes

Colour-coded SOD-123 diodes. Devices marked with letter/number codes will be found in the main list.

CATHODE BAND	Devices
Red	BA620, BB620
Yellow	BA619, BB619
Green	BA585
Blue	BA582, 583, 584
White	BA512, 515, BB515, 811

### HP diode coding

HP diodes appear to follow a regular coding scheme. Although this is not always followed, it may help in identifying diodes and package styles if used with caution. Not all HP diodes follow this scheme, so beware!

The general type number scheme is: **HSMX-123#**

**HSM** stands for HP Surface Mount, I suppose!

**X** is either **S** for a schottky diode or **P** for a PIN diode.

**#** is a letter for a SOT323 package and a number for a SOT23 device.

It denotes the internal arrangement - single, common anode pair, quad, etc. The digit of the code marked on the package itself usually corresponds to the package style (#) number. The numbers and letters correspond to the following arrangements:

Device style	# SOT-23	# SOT-323	Printed on package	Codebook base
Single diode - standard	0	B	0	C
Single diode - reverse	1	A	1	K
Dual series - standard	2	C	2	D
Dual series - reverse	2	C	2	Z
Common anode pair	3		3	A
Common cathode pair	4		4	B
Unconnected pair	5		5	S
Ring Quad	7		7	RQ
Bridge Quad	8		8	BQ
Dual Anode			A	Y
Dual Cathode			B	J

### SOD-80 Package Diodes

The SOD-80 package, also known as a MELF, is a small glass cylinder with metal ends.

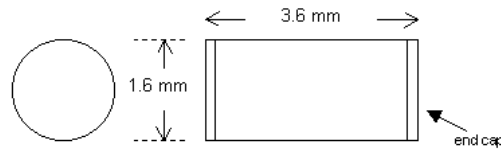

#### Code marked devices

Marked 2Y4 to 75Y (E24 series) BZV49 series 1W zener diodes (2.4 - 75V)

Marked C2V4 TO C75 (E24 series) BZV55 series 500mW zener diodes (2.4 - 75V)

The cathode end is indicated by a coloured band.

---

#### Coloured band marked devices

CATHODE BAND(S)	Device
Black	BAS32, BAS45, BAV105 LL4148, 50, 51,53, LL4448 BB241, BB249
Black Brown	LL4148, LL914
Black Orange	LL4150, BB219
Brown Green	LL300
Brown Black	LL4448
Red	BA682
Red Orange	BA683
Red Green	BA423L
Red WHite	LL600
Orange Yellow	LL3595
Yellow	BZV55, BZV80, BZV81 series zeners
Green	BAV105, BB240
Green Black	BAV100
Green Brown	BAV101
Green Red	BAV102
Green Orange	BAV103
Grey	BAS81, 82, 83, 85, 86
White	BB219
White Green	BB215

电子元件专业交流平台，专业MARKINGCODE交流平台，诚邀你的参与：

<http://tieba.baidu.com/club/10468944>

承接各类贴片丝印查询，需要的话联系

联系人：曾先生 13662236349 QQ:372613373

[Http://www.kssdz.com.cn](http://www.kssdz.com.cn)