

Universal Input, Single High Brightness, LED Driver Demoboard

General Description

The Supertex HV9931DB5 demoboard is a high brightness (HB) LED power driver to supply one HB LED, using the HV9931 IC from either a 110 or 220VAC supply. The HV9931DB5 is ideal for incandescent retrofit applications, as it features a very small size and a low component count.

The HV9931DB5 avoids the use of electrolytic capacitors, which reduce the lifetime of the circuit in high ambient temperatures (which would be found in the base of a bulb). The demo board can be used to test the performance of the HV9931 as a constant current driver to power LEDs.

The HV9931DB5 uses a unique cascaded converter circuit, with a single active switch, to achieve the high step down conversion ratio required for operating low voltage LEDs from a high input voltage. This circuit allows the converter to operate at a high switching frequency, about 120kHz, while still regulating the output current at all times. The HV9931DB5 supplies 350mA to a 4.0V(max) LED with input voltages ranging from 90 – 265VAC 50/60Hz.

Specifications

Parameter	Value
Input	90 – 265V AC, 50/60Hz
LED current set point	350mA ± 10%
Maximum output voltage	4.0V
Switching frequency	variable (constant off-time, $T_{OFF} = 8.0\mu s$)
Board dimensions	OD = 29mm, HT = 15mm

Board Layout and Connections

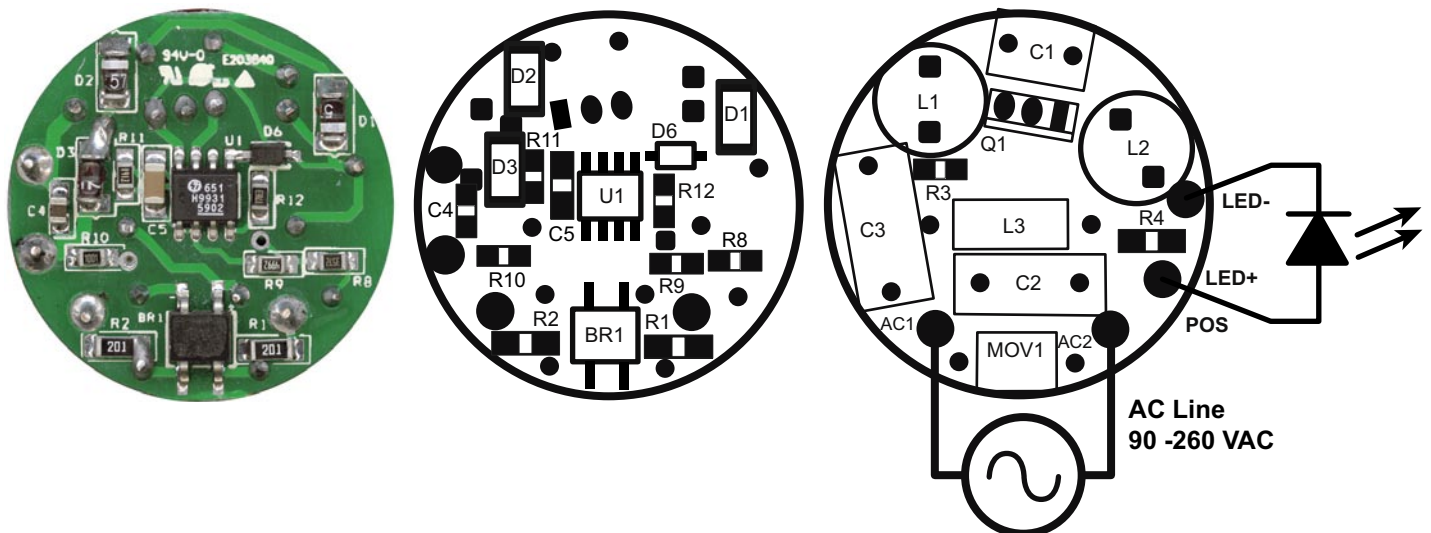

Connections:

1. Connect the universal input to the AC IN terminals.
2. Connect the output to the LED terminals:
 - Red wire to anode of LED
 - Black wire to cathode of LED.

Testing the HV9931DB5:

Place an ammeter in series with the LED to measure the LED current. The LED should glow when the AC power is turned on.

Note on Current Measurement:

The HV9931DB5 is designed to regulate the output current at 350mA (the recommended current level for most 1.0W HB LEDs). This can easily be verified by applying a DC voltage greater than 50V at the input of the demo board. However, when the output current is measured with an AC waveform, the measured current is typically around

300mA. This drop in the current is due to the demo board turning off when the instantaneous input voltage is less than 40V. This dropout at low voltages causes the average current to drop by about 50mA. The output current can be increased or decreased by increasing the value of resistor R10 proportionally.

Open LED Protection:

The HV9931DB5 is not protected against open LED conditions. Leaving the LED terminals open while applying an input voltage will damage the circuit.

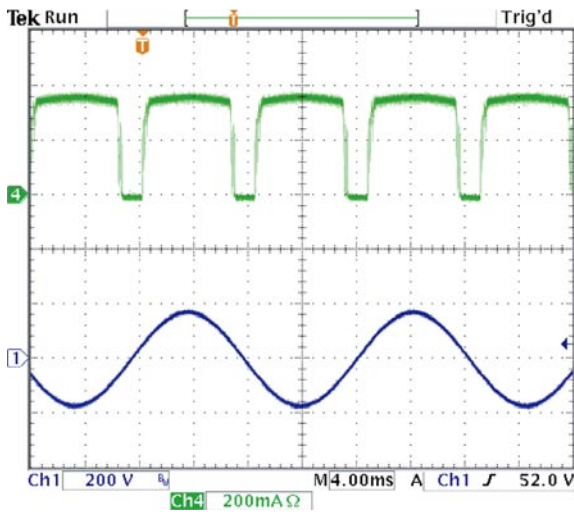

Fig. 1: Output Current at 120V Input Voltage

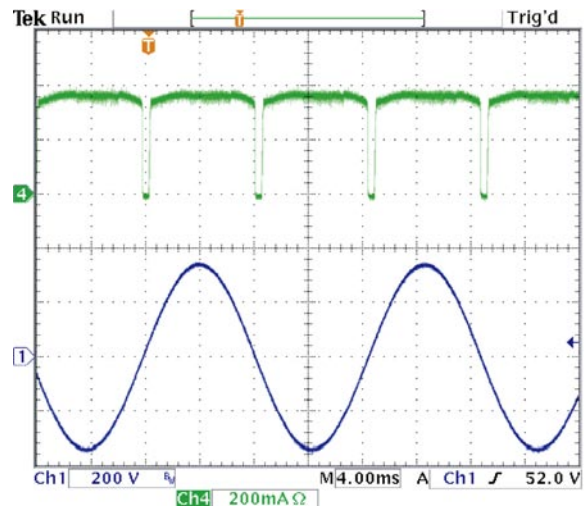

Fig. 2: Output Current at 240V Input Voltage

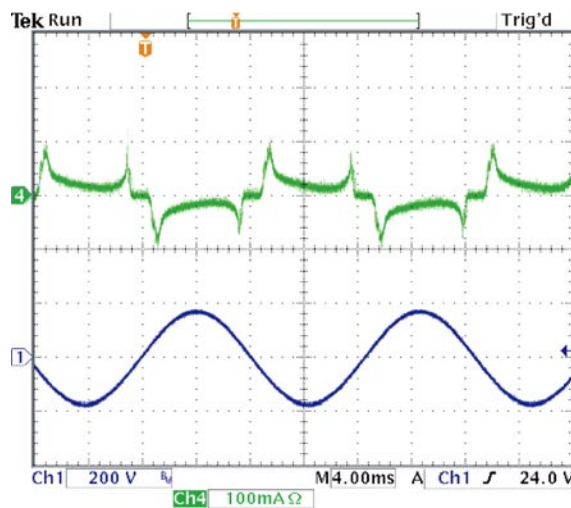

Fig. 3: Input Voltage and Current Waveforms at 120VAC Input

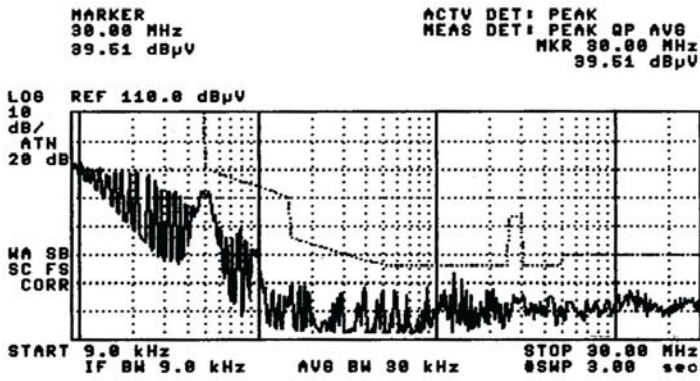

Fig. 4a: Conducted EMI test (CISPR 15) at 120VAC

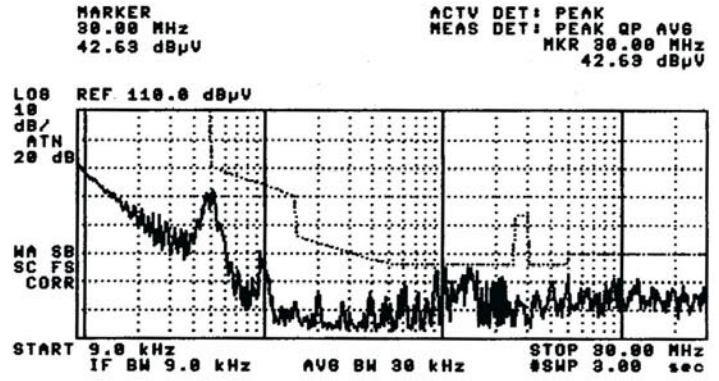
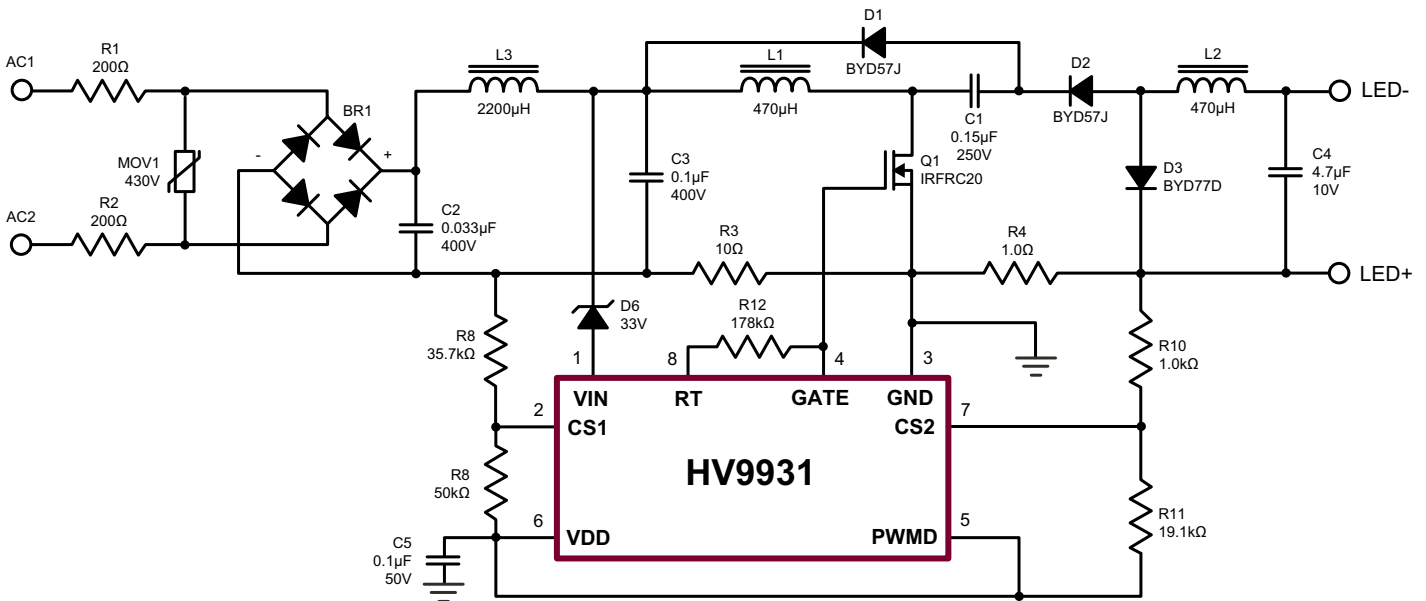
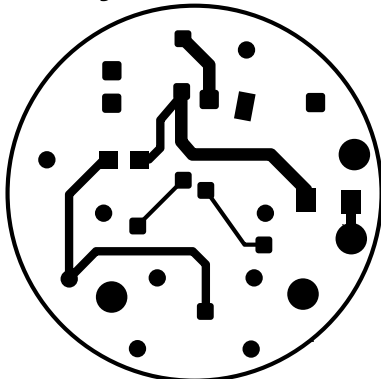

Fig. 4b: Conducted EMI test (CISPR 15) at 240VAC

Schematic Diagram



HV9931DB5 PCB Layers



Top Layer

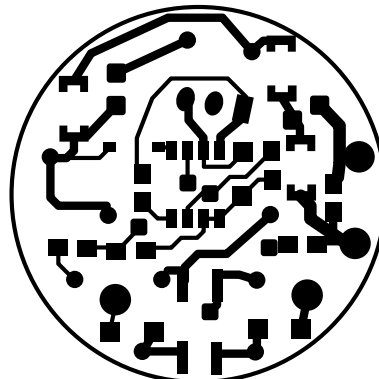

Bottom Layer

Bill of Materials

Quan	Ref Des	Description	Package	Manufacturer	Manufacturer's Part Number
1	BR1	Rectifier Bridge GP 600V 0.8A	MiniDIP	Diodes Inc	HD06-T
1	C1	Capacitor 150nF 250VDC polyester film	TH	Panasonic	ECQ-E2154KB
1	C2	Capacitor 33nF 400VDC polyester film	TH	Panasonic	ECQ-E4333KF
1	C3	Capacitor 100nF 400VDC polyester film	TH	Panasonic	ECQ-E4104KF
1	C4	Capacitor 4.7µF 10VDC ceramic X7R	1206	Murata Electronics	GRM31CR71A475MA01L
1	C5	Capacitor 0.1µF 50VDC ceramic X7R	1206	Kemet	C0805C103K5RACTU
2	D1, D2	Diode ultra fast SW 600V 1A	SOD87	Philips	BYD57J
1	D3	Diode ultra fast SW 200V 2A	SOD87	Philips	BYD77D
1	D6	Diode Zener 33V 500mW	SOT-123	Diodes Inc	BZT52C33-7
1	Q1	MOSFET 600V 2A I-PAK	TH	IR	IRFUC20
1	U1	LED Driver IC	SO-8	Supertex Inc	HV9931LG
1	MOV1	Varistor 275V RMS	TH	Littelfuse Inc	V430MA7B
2	L1, L2	Inductor radial 470µH	TH	C&D Technologies	17474
1	L3	2.2mH, 64mA, axial	TH	Central Technologies	CTH6-222K
2	R1, R2	Resistor 200Ω 1/4W 5% Surge	1206	Panasonic	9C12063A2000FKHFT
1	R3	Resistor 10Ω 1/8W 1%	0805	Yageo America	RC0805FR-0710L
1	R4	Resistor 1.0Ω 1/4W 1% 1206 SMD	1206	Yageo America	9C12063A1R0FKHFT
1	R9	Resistor 50.0kΩ 1/8W 1%	0805	Yageo America	RC0805FR-0750KL
1	R11	Resistor 19.1kΩ 1/8W 1%	0805	Yageo America	RC0805FR-0719K1L
1	R8	Resistor 35.7kΩ 1/8W 1%	0805	Yageo America	RC0805FR-0735K7L
1	R10	Resistor 1.0kΩ 1/8W 1%	0805	Yageo America	RC0805FR-071K0L
1	R12	Resistor 178kΩ 1/8W 1%	0805	Yageo America	RC0805FR-07178KL

Supertex inc. does not recommend the use of its products in life support applications, and will not knowingly sell them for use in such applications unless it receives an adequate "product liability indemnification insurance agreement." **Supertex inc.** does not assume responsibility for use of devices described, and limits its liability to the replacement of the devices determined defective due to workmanship. No responsibility is assumed for possible omissions and inaccuracies. Circuitry and specifications are subject to change without notice. For the latest product specifications refer to the **Supertex inc.** (website: <http://www.supertex.com>)