



使用LNK605芯片设计的12V 300mA LED
驱动电源

2010年5月5日
TH (PI-Shenzhen)



1. 主要功能及特点

1. 无 Y 电容设计
2. 初级侧精准的恒流控制，无需光耦和次级控制线路
3. 集成MOS管，外围零件数目少，能放入GU10壳内
4. 高效率，115V/230V输入时效率大于76%
5. 宽电压范围输入（90~265Vac）
6. 内部集成过温度保护功能，~142°C
7. 短启动时间，<200mS@90Vac

2. 产品规格

工程报告 (使用LNK605DG芯片设计的 12V 300mA LED 驱动电源)

描述	符号	最小值	典型值	最大值	单位	附加信息/测试条件
输入						
输入电压	V_{IN}	90		265	Vac	零/火线, 无中线
空载损耗	W			0.1		265V输入
输出						
输出电压	Vout		12.0		V	
输出电流	Iout		0.3		A	
总输出功率						
持续输出功率	Pout		3.6		W	总功率
峰值输出功率					W	
传到电磁干扰		6			dB	
环境温度	Tamb	0		70	C	空气自然对流

3. 线路图

工程报告 (使用LNK605DG芯片设计的 12V 300mA LED 驱动电源)

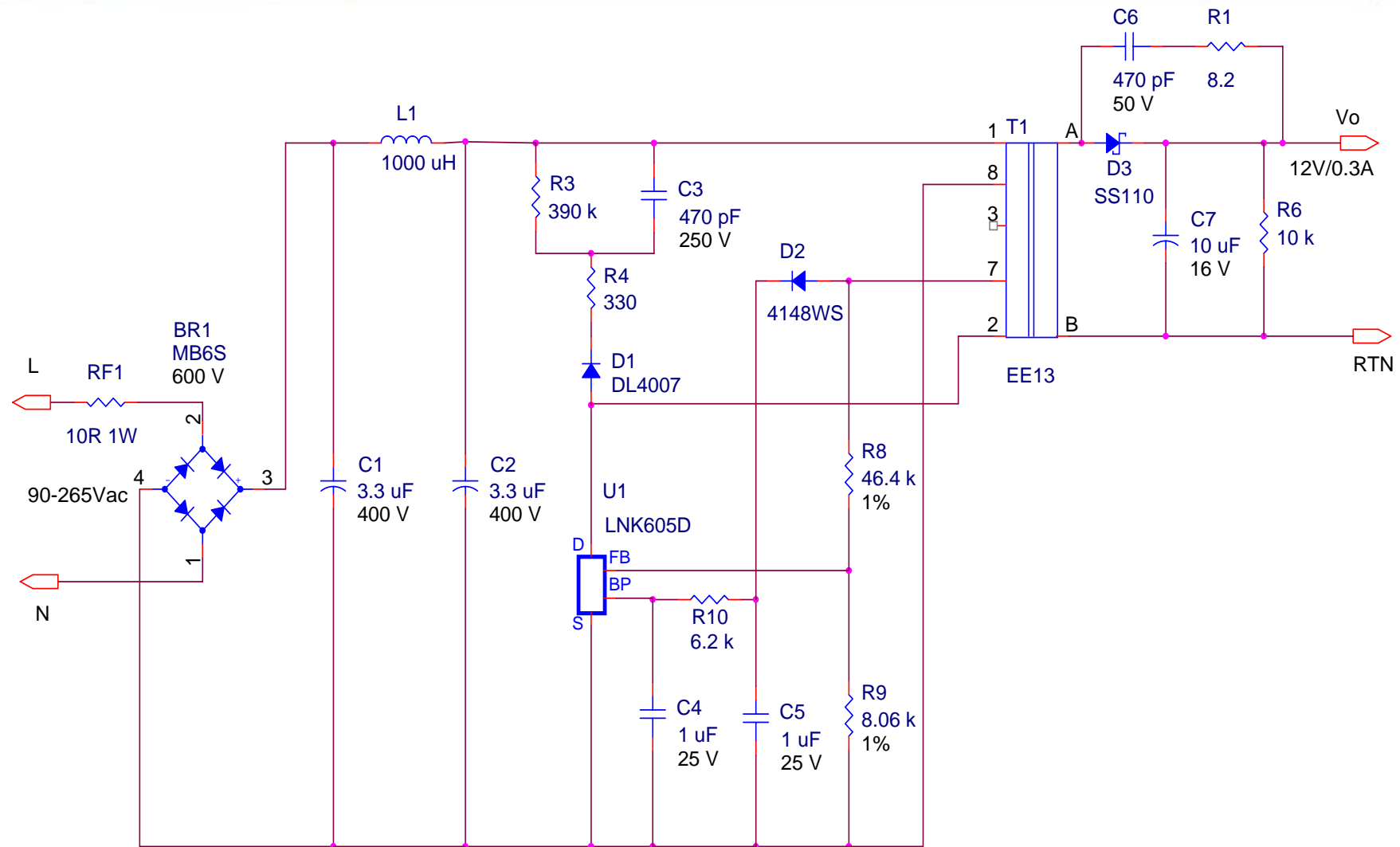

4. 零件清单

工程报告 (使用LNK605DG芯片设计的 12V 300mA LED 驱动电源)

编码	数量	零件位置	零件值	具体描述
1	1	BR1	MB6S	600 V, 0.5 A, Bridge Rectifier, SMD, DFS, SOIC-4
2	2	C1 C2	3.3 uF	3.3 uF, 400 V, Electrolytic, (10 x 12.5)
3	1	C3	470 pF	470 pF, 250 V, Ceramic, X7R, 0805
4	2	C4 C5	1 uF	1 uF, 25 V, Ceramic, X7R, 0805
5	1	C6	470 pF	470 pF 50 V, Ceramic, X7R, 0603
6	1	C7	10 uF	10 uF, 16 V, Ceramic, X7R, SMD 1206
7	1	D1	DL4007	1000 V, 1 A, Rectifier, Glass Passivated, DO-213AA (MELF)
8	1	D2	4148WS	75 V, 0.15 A, Fast Switching, 4 ns, MELF
9	1	D3	SS110	100 V, 1 A, Schottky, DO-214AC (SMA)
10	1	L1	1000 uH	1000 uH, 80 mA, 34.7 Ohm, Axial Ferrite Inductor
11	1	R1	8.2	8.2 R, 1%, 1/16 W, Thick Film, 0603
12	1	R3	390 k	390 k, 5%, 1/4 W, Thick Film, 1206
13	1	R4	330	330 R, 5%, 1/8 W, Thick Film, 0805
14	1	R6	10 k	10 k, 5%, 1/8 W, Thick Film, 0805
15	1	R8	46.4 k	46.4 k, 1%, 1/8 W, Thick Film, 0805
16	1	R9	8.06 k	8.06 k, 1%, 1/16 W, Thick Film, 0603
17	1	R10	6.2 k	6.2 k, 5%, 1/8 W, Thick Film, 0805
18	1	RF1	10R 1W	10 R, 1 W, Fusible/Flame Proof Wire Wound
19	1	T1	EE13	EE13, Horizontal , 8 pins
20	1	U1	LNK605D	LinkSwitch-II, LNK605DG, SMD-8B

5.工程样品外观图

工程报告 (使用LNK605DG芯片设计的 12V 300mA LED 驱动电源)

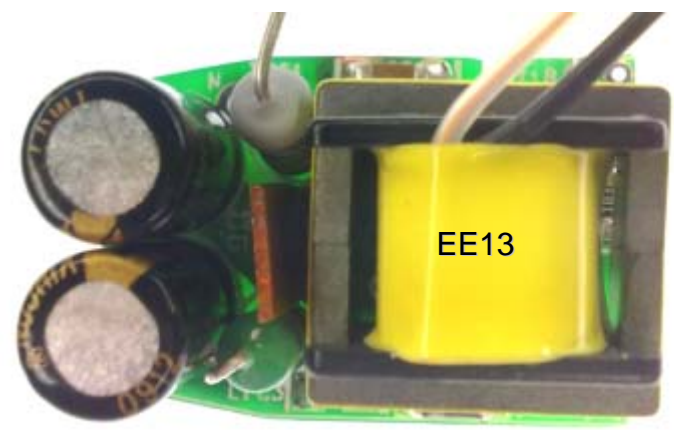
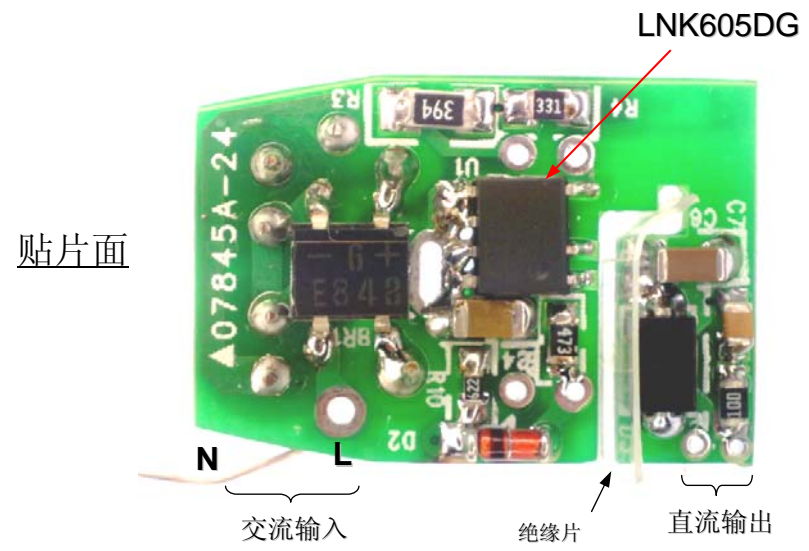

Assembly Details

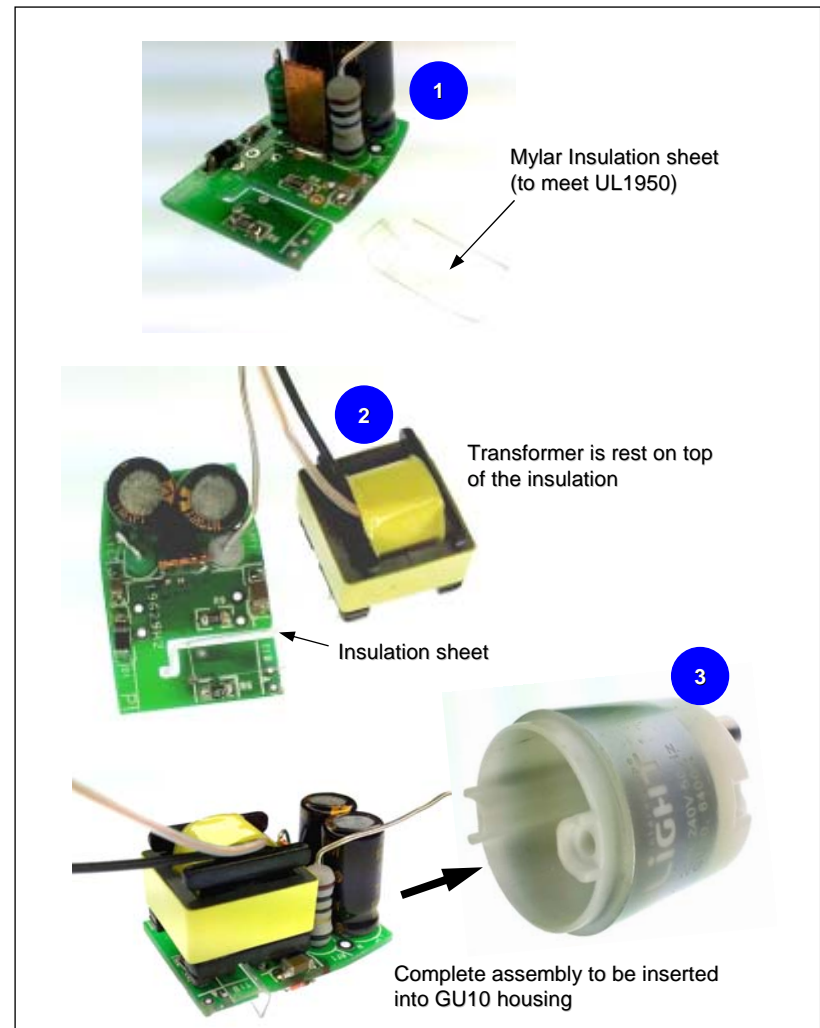

6. 布板图

Primary
Top side
(Component side)

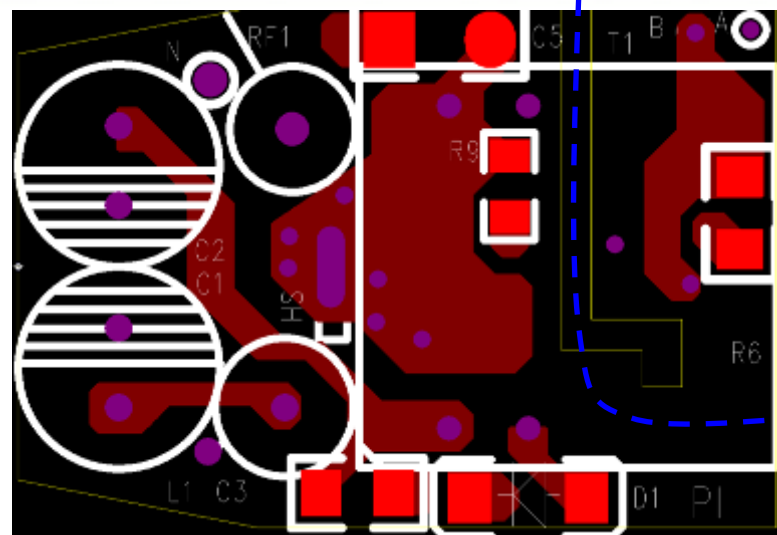

Secondary

Bottom side
(Solder side)

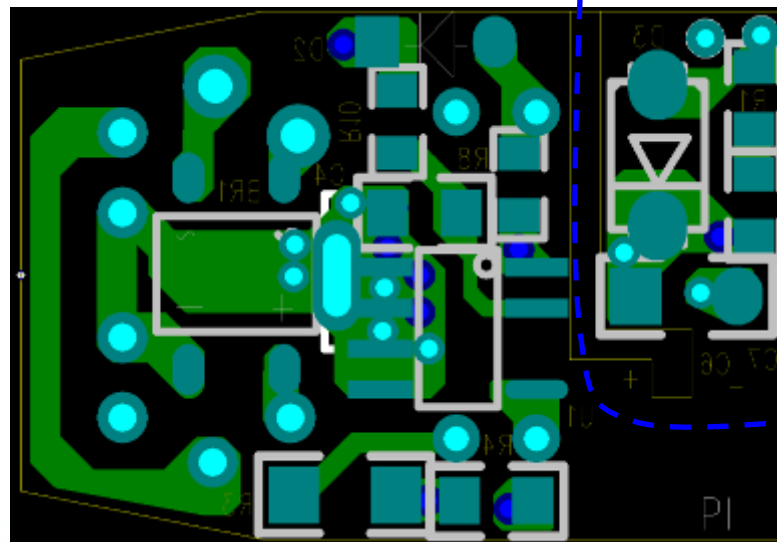

7. 变压器规格

示意图

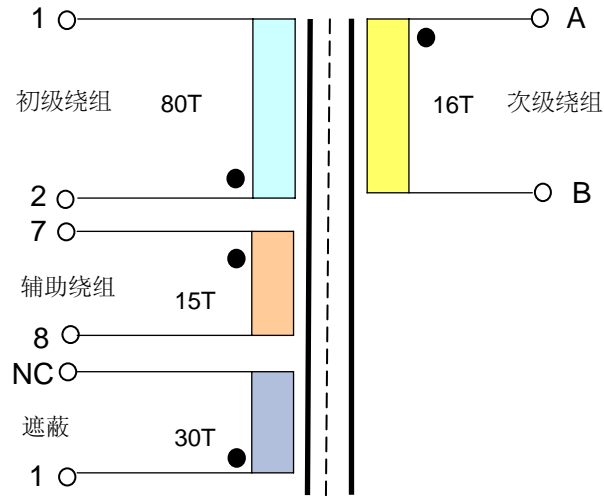

电气规格:

1. 初级感量 (Lp) = 1100 uH ± 7% @80KHz 0.4V
2. 初级漏感 <30uH @80KHz 0.4V
3. 抗电强度 = 3KV, 50/60Hz, 1Min

材料:

1. 磁芯: 特殊EE13 (铁氧体 TDK PC40 或其他等效)
2. 骨架: 卧式 (4+4 脚).
3. 绕线 (初级和辅助绕组): 类型 2-UEW
4. 绕线 (次级绕组): 三层绝缘线
5. 绕组间绝缘胶布 :3M1298 或其他等效

组装:

1. 组立后需要泡凡立水

绕组结构图...

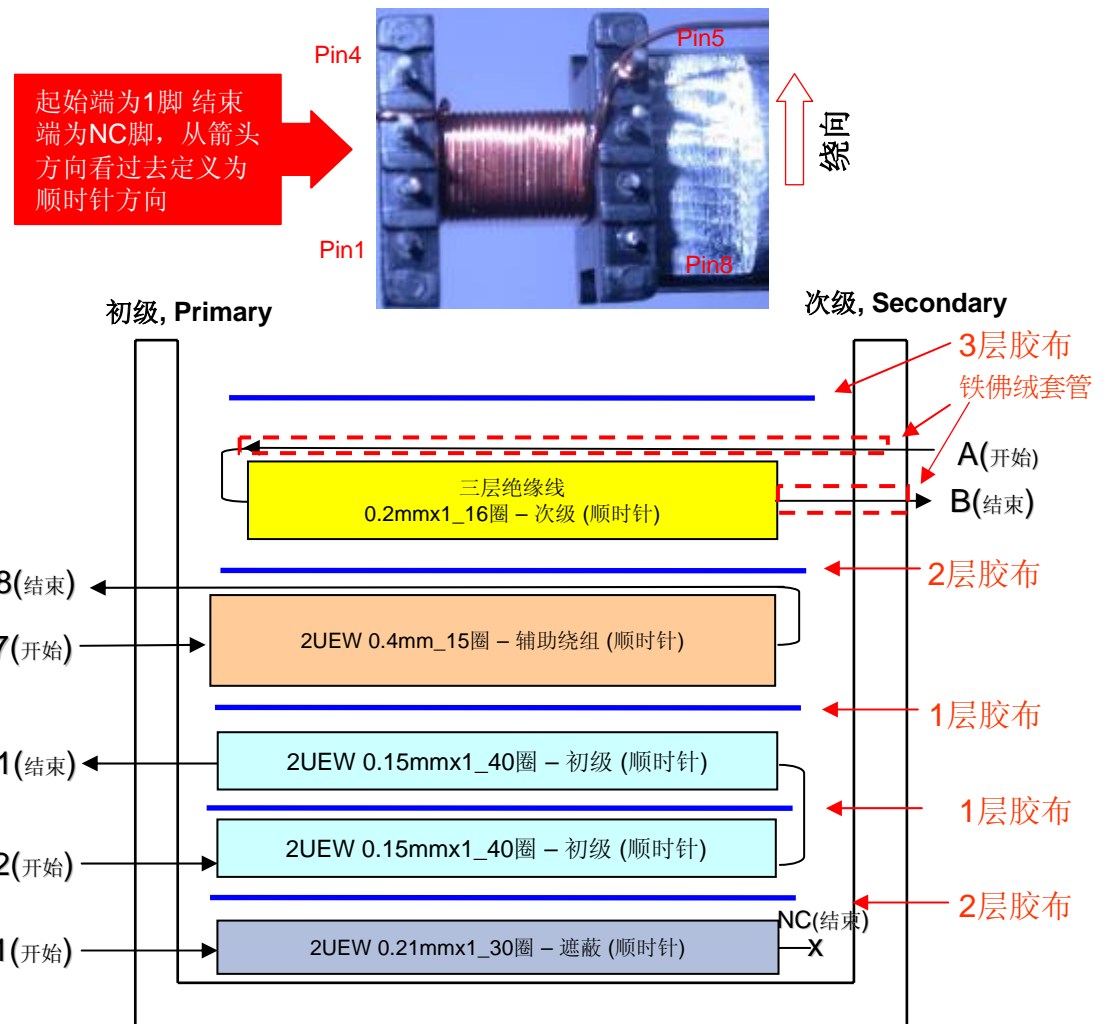

8. 电气性能

空载损耗图

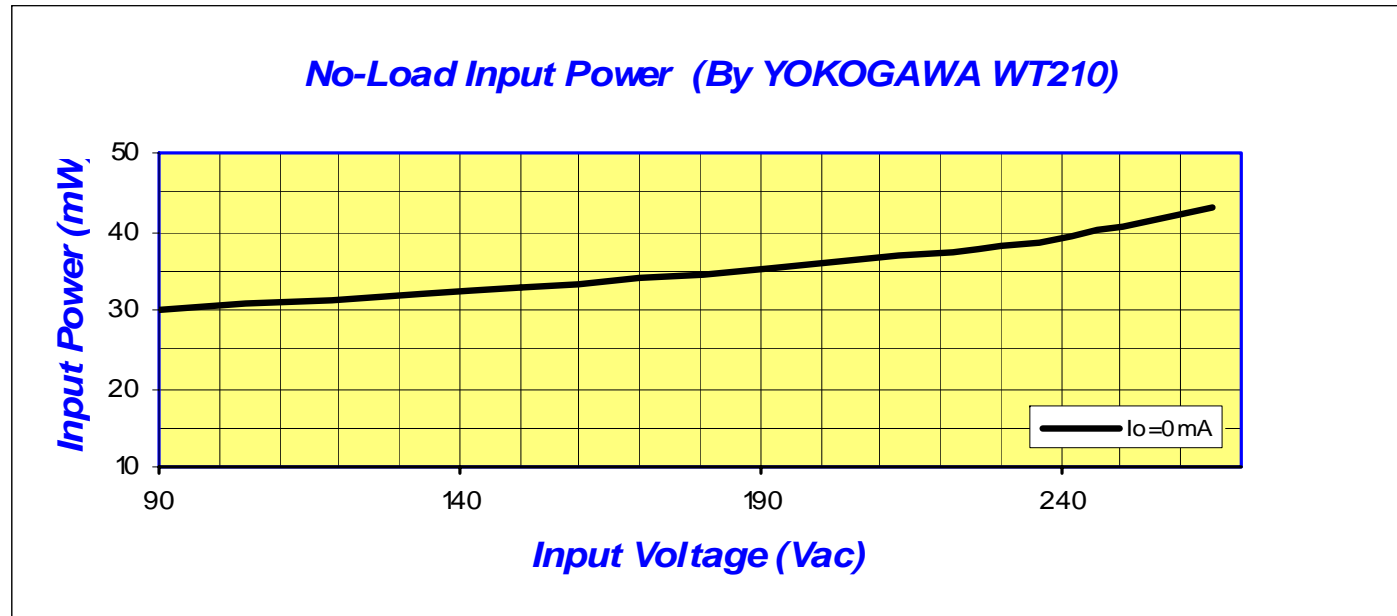

效率

测试条件:满载

输入	90V	115V	150V	200V	230V	265V
效率	75.50%	77.00%	77.50%	77.10%	76.50%	75%

9. 输出电压电流曲线图

工程报告 (使用LNK605DG芯片设计的 12V 300mA LED 驱动电源)

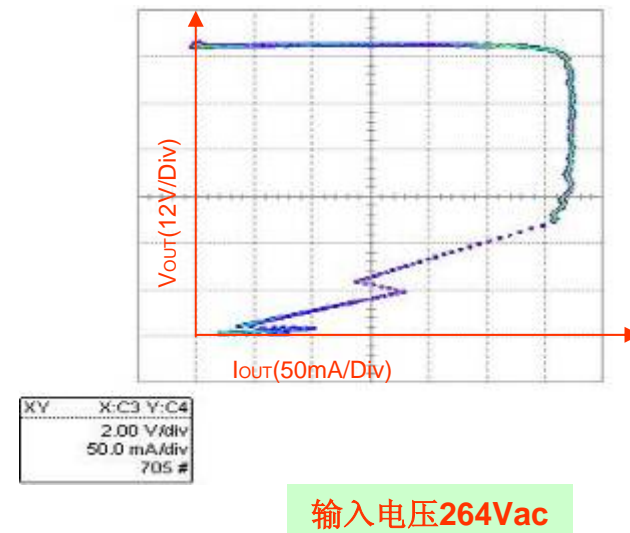
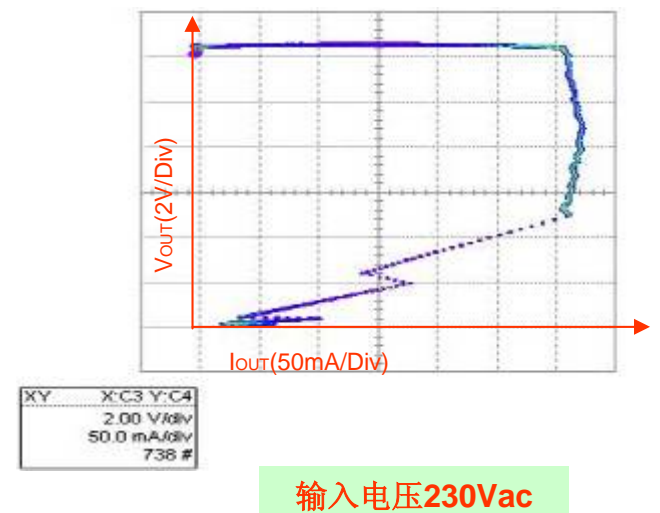
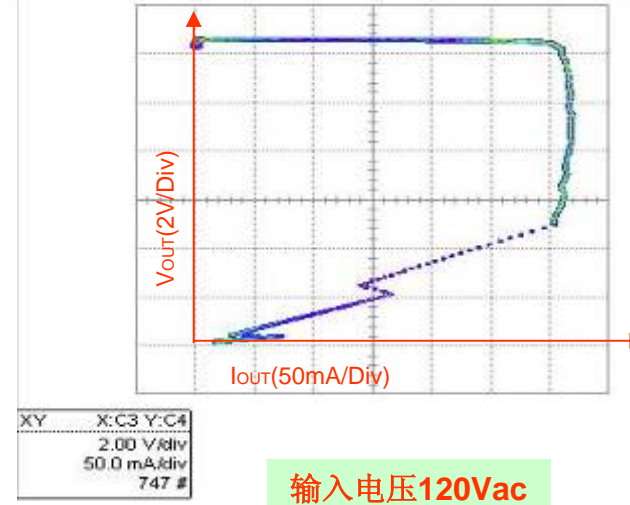
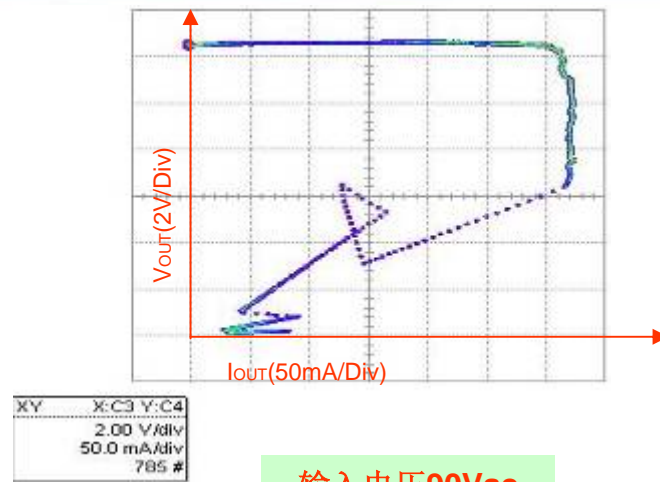

10. 漏极电压应力

工程报告 (使用LNK605DG芯片设计的 12V 300mA LED 驱动电源)

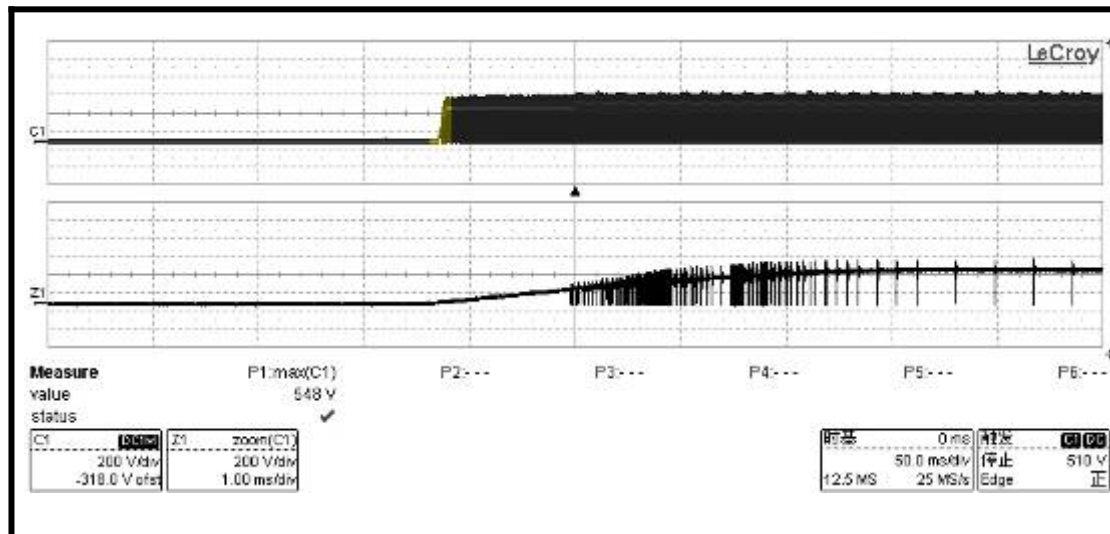

测试条件:
265VAC电压输入
输出电流0.3A

结果: 通过
最大应力电压=**548V**

LNK-II 最大允许数据值表 — — — — — (LNK605DG)

Absolute Maximum Ratings⁽¹⁾

DRAIN Voltage	-0.3 V to 700 V	Lead Temperature ⁽²⁾	260 °C
DRAIN Peak Current: LNK603/613	320 (480) mA ⁽³⁾	Notes:	
LNK604/614	400 (600) mA ⁽³⁾	1. All voltages referenced to SOURCE, T _a = 25 °C.	
LNK605/615	504 (750) mA ⁽³⁾	2. Duration not to exceed 2 msec.	
LNK606/616	654 (980) mA ⁽³⁾	3. 1/16 in. from case for 5 seconds.	
Peak Negative Pulsed Drain Current	-100 mA ⁽³⁾	4. The higher peak DRAIN current is allowed while the DRAIN voltage is simultaneously less than 400 V.	
Feedback Voltage	-0.3 V to 9 V	5. Maximum ratings specified may be applied, one at a time without causing permanent damage to the product. Exposure to Absolute Maximum ratings for extended periods of time may affect product reliability.	
Feedback Current	100 mA		
BYPASS Pin Voltage	-0.3 V to 9 V		
Storage Temperature	-65 °C to 150 °C		
Operating Junction Temperature.....	-40 °C to 150 °C		

Thermal Impedance

Thermal Impedance: P or G Package:	
(θ _{JA})	70 °C/W ⁽⁴⁾ ; 60 °C/W ⁽⁵⁾
(θ _{JC}) ⁽⁶⁾	11 °C/W
D Package:	
(θ _{JA})	100 °C/W ⁽⁴⁾ ; 80 °C/W ⁽⁵⁾
(θ _{JC}) ⁽⁶⁾	30 °C/W

- Notes:
1. Measured on pin 8 (SOURCE) close to plastic interface.
 2. Soldered to 0.36 sq. in. (232 mm²), 2 oz. (610 g/m²) copper clad.
 3. Soldered to 1 sq. in. (645 mm²), 2 oz. (610 g/m²) copper clad.

11.传导电磁干扰测试 (准峰值和平均值)

工程报告 (使用LNK605DG芯片设计的 12V 300mA LED 驱动电源)

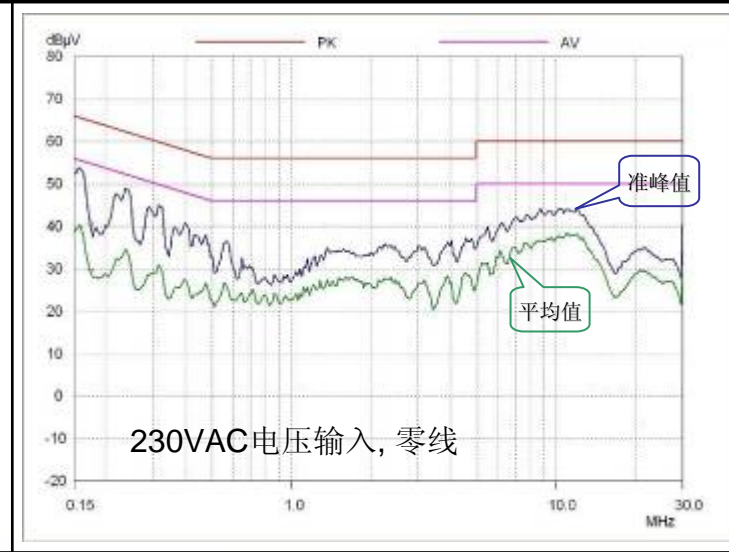
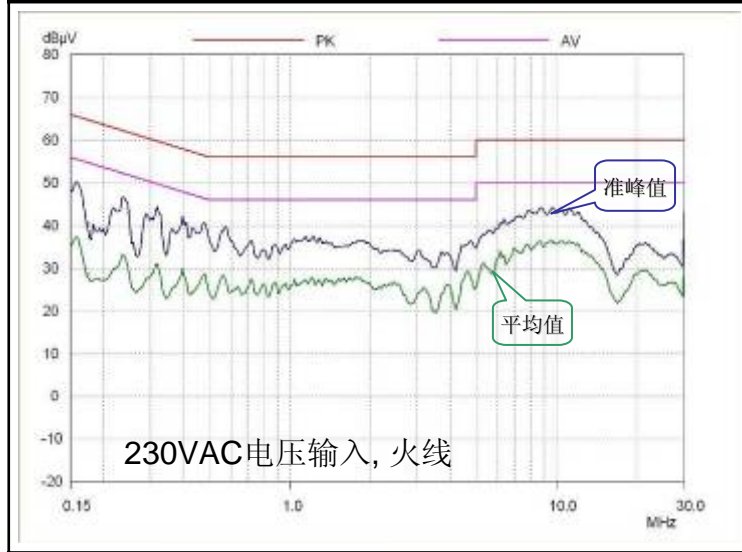
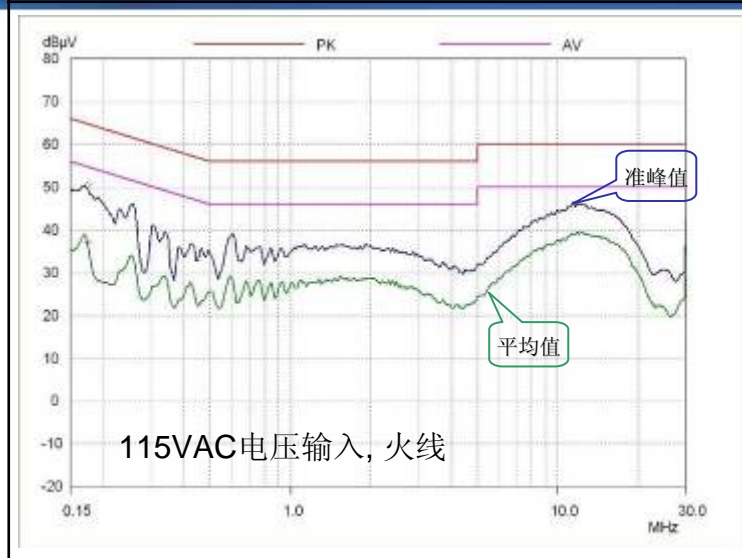

12. 静电测试结果

ESD(KV)	PASS OR FAILURE
10KV	PASS
11KV	PASS
12KV	PASS
13KV	PASS
14KV	PASS

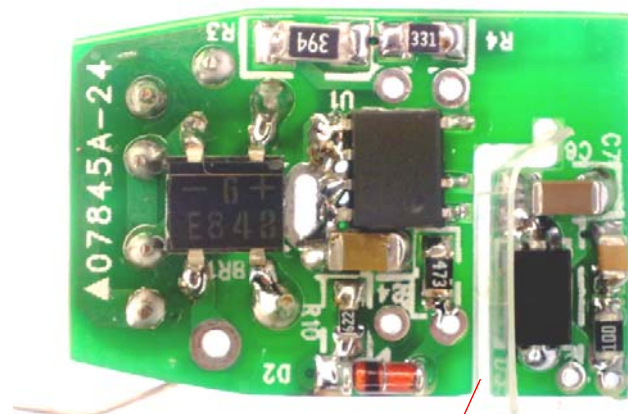

备注: 绝缘片放入初次之间有起到静电ESD保护作用

13. 温度上升测试结果

工程报告 (使用LNK605DG芯片设计的 12V 300mA LED 驱动电源)

	Input:90Vac Amb:70°C	Input:264Vac Amb:70°C
Device	Temperature	Temperature
U1(LNK605DG)	112	115
T1(winding)	96.1	97
T1(core)	101.1	102.5
D2(SS110)	94.7	94.9
C1(3.3uF/400V)	92.9	91
C2(3.3uF/400V)	93.3	91.6

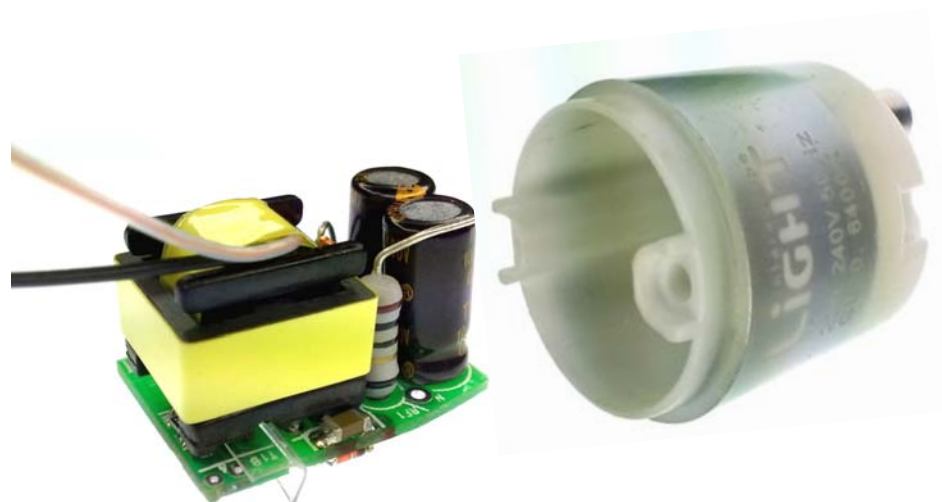

14. 雷击应力测试状态

工程报告 (使用LNK605DG芯片设计的 12V 300mA LED 驱动电源)



14.A 雷击应力测试结果 (通过2KV)

工程报告 (使用LNK605DG芯片设计的 12V 300mA LED 驱动电源)



深圳市华标电子科技有限公司
Bontek Compliance Testing Laboratory Ltd

编号: TR-4-E-005 Rev:A.0

Surge Immunity Test Data

Applicant: PI

EUT: _____ M/N: GU10

Standard: EN 61000-4-5
 IEC 61000-4-5

Result: PASS / FAIL

Repetition: 5 times per test Interval: 60 seconds Criteria: B C

Ambient Condition: 25 °C 55 %RH 101 kPa

Input Voltage: 230 V 50 Hz

Operation Mode: FULL LOAD

Line:	<input checked="" type="checkbox"/> AC Mains		<input type="checkbox"/> DC Supply		<input type="checkbox"/> Signal Line		Telephone Line				
	Volt	Phase	500V	+	1.0kV	+	2.0kV	+	3.0kV	+	4.0kV
Conductor	0°				PASS		PASS		PASS		PASS
	90°				PASS		PASS		PASS		PASS
	180°				PASS		PASS		PASS		PASS
	270°				PASS		PASS		PASS		PASS
L-N	0°										
	90°										
	180°										
L-PE	0°										
	90°										
	180°										
N-PE	0°										
	90°										
	180°										
L-N-PE	0°										
	90°										
	180°										
Telephone Line	0°										
	90°										
	180°										

Note: _____

Date: 2010.4.30

Test: 2010.4.30

Approve: _____

Test Equipment: SCHAFFNER Model: MODULA6150



深圳市福田区福强街道华强工业区H3栋1楼(与包达45号旁)
Fl. 1, Building H-3, Hua Qiao Chung Hwa Industrial Area, Qiaochang East Road, Nanshan, Shenzhen, P. R. China
Tel: +86 755 86106130 Fax: +86 755 86095568

China Sale Contacts and Important Note

Page 17

工程报告 (使用LNK605DG芯片设计的 12V 300mA LED 驱动电源)

China Sales Contacts

CHINA (Shanghai)

Room 1601/1610, Tower 1
Kerry Everbright City
No.218 Tianmu Road West
Shanghai, PRC 200070
TEL: +86-21-6354 6323
FAX: +86-21-6354 6325
E-mail: chinasales@powerint.com

CHINA (Shenzhen)

Rooms A, B and C, 4th Floor, Block
C. Electronic Science & Technology
Bldg. 2070 Shennan Zhong Road
Shenzhen, Guangdong
China, 518031
TEL:+86-755-8379-3243
FAX:+86-755-8379-5828
E-mail: chinasales@powerint.com

CHINA (PI Guangzhou Lab)

Room 311,3rd floor, No.9, Jianggong
Road, Tianhe Software Park,
Zhongshan thoroughfare,
Tianhe District, Guangzhou,
China, 510660
TEL:+86 20-8566-4509
FAX:+86 20-8555-1081
E-mail: chinasales@powerint.com

CHINA (PI Chengdu Lab)

Room 1426,Colorful Holiday
Internation Mansion
No.2 Baisi Street,Chengdu,
China, 610016
TEL: +86-28-8676-3012
FAX: +86-28-8676-3011
E-mail: chinasales@powerint.com

中国上海

上海市天目西路218号
嘉里不夜城第一座1601/1610室
邮编: 200070
电话:+86-21-6354 6323
传真:+86-21-6354 6325
电子邮件: chinasales@powerint.com

中国深圳

深圳市深南中路2070号
电子科技大厦C座4楼A,B,C,室
邮编: 518031
电话:+86-755-8379-3243
传真:+86-755-8379-5828
电子邮件: chinasales@powerint.com

中国深圳-广州实验室

广州市天河区中山大道
天河软件园建工路9号3楼311室
邮编:510660
电话:+86-20-8566-4509
传真 +86 20-8555-1081
E-mail: chinasales@powerint.com

中国深圳-成都实验室

四川省成都市白丝街2号
缤纷假日国际公寓1426号
邮编:610016
电话:+86-28-8676-3012
传真:+86-28-8676-3011
E-mail: chinasales@powerint.com

Important note

Although this board is designed to satisfy safety isolation requirements, the engineering prototype has not been agency approved. Therefore, all testing should be performed using an isolation transformer to provide the AC input to the prototype board.

The products and applications illustrated herein (including circuits external to the products and transformer construction) may be covered by one or more U.S. and foreign patents or potentially by pending U.S. and foreign patent applications assigned to Power Integrations. A complete list of Power Integrations' patents may be found at www.powerint.com.