



Feb 2003

AO4606

Complementary Enhancement Mode Field Effect Transistor

General Description

The AO4606 uses advanced trench technology MOSFETs to provide excellent $R_{DS(ON)}$ and low gate charge. The complementary MOSFETs may be used to form a level shifted high side switch, and for a host of other applications.

Features

n-channel	p-channel
$V_{DS} (V) = 30V$	-30V
$I_D = 6.9A$	-6A
$R_{DS(ON)}$	$R_{DS(ON)}$
$< 28m\Omega (V_{GS}=10V)$	$< 35m\Omega (V_{GS} = 10V)$
$< 42m\Omega (V_{GS}=4.5V)$	$< 58m\Omega (V_{GS} = 4.5V)$



Absolute Maximum Ratings $T_A=25^\circ C$ unless otherwise noted

Parameter	Symbol	Max n-channel	Max p-channel	Units	
Drain-Source Voltage	V_{DS}	30	-30	V	
Gate-Source Voltage	V_{GS}	± 20	± 20	V	
Continuous Drain Current ^A	I_D	$T_A=25^\circ C$	6.9	-6	A
		$T_A=70^\circ C$	5.8	-5	
Pulsed Drain Current ^B	I_{DM}	30	-30		
Power Dissipation	P_D	$T_A=25^\circ C$	2	2	W
		$T_A=70^\circ C$	1.44	1.44	
Junction and Storage Temperature Range	T_J, T_{STG}	-55 to 150	-55 to 150	$^\circ C$	

Thermal Characteristics: n-channel and p-channel

Parameter	Symbol	Device	Typ	Max	Units
Maximum Junction-to-Ambient ^A	$R_{\theta JA}$	n-ch	48	62.5	$^\circ C/W$
Maximum Junction-to-Ambient ^A		n-ch	74	110	$^\circ C/W$
Maximum Junction-to-Lead ^C	$R_{\theta JL}$	n-ch	35	60	$^\circ C/W$
Maximum Junction-to-Ambient ^A	$R_{\theta JA}$	p-ch	48	62.5	$^\circ C/W$
Maximum Junction-to-Ambient ^A		p-ch	74	110	$^\circ C/W$
Maximum Junction-to-Lead ^C	$R_{\theta JL}$	p-ch	35	40	$^\circ C/W$

N-Channel Electrical Characteristics ($T_J=25^\circ\text{C}$ unless otherwise noted)

Symbol	Parameter	Conditions	Min	Typ	Max	Units
STATIC PARAMETERS						
BV_{DSS}	Drain-Source Breakdown Voltage	$I_D=250\mu\text{A}$, $V_{GS}=0\text{V}$	30			V
I_{DSS}	Zero Gate Voltage Drain Current	$V_{DS}=24\text{V}$, $V_{GS}=0\text{V}$ $T_J=55^\circ\text{C}$			1	μA
					5	
I_{GSS}	Gate-Body leakage current	$V_{DS}=0\text{V}$, $V_{GS}=\pm 20\text{V}$			100	nA
$V_{GS(th)}$	Gate Threshold Voltage	$V_{DS}=V_{GS}$, $I_D=250\mu\text{A}$	1	1.9	3	V
$I_{D(ON)}$	On state drain current	$V_{GS}=4.5\text{V}$, $V_{DS}=5\text{V}$	20			A
$R_{DS(ON)}$	Static Drain-Source On-Resistance	$V_{GS}=10\text{V}$, $I_D=6.9\text{A}$ $T_J=125^\circ\text{C}$		22.5	28	m Ω
				31.3	38	
			$V_{GS}=4.5\text{V}$, $I_D=5.0\text{A}$		34.5	
g_{FS}	Forward Transconductance	$V_{DS}=5\text{V}$, $I_D=6.9\text{A}$	10	15.4		S
V_{SD}	Diode Forward Voltage	$I_S=1\text{A}$		0.76	1	V
I_S	Maximum Body-Diode Continuous Current				3	A
DYNAMIC PARAMETERS						
C_{iss}	Input Capacitance	$V_{GS}=0\text{V}$, $V_{DS}=15\text{V}$, $f=1\text{MHz}$		680		pF
C_{oss}	Output Capacitance			102		pF
C_{riss}	Reverse Transfer Capacitance			77		pF
R_g	Gate resistance	$V_{GS}=0\text{V}$, $V_{DS}=0\text{V}$, $f=1\text{MHz}$		3		Ω
SWITCHING PARAMETERS						
$Q_g(10\text{V})$	Total Gate Charge	$V_{GS}=10\text{V}$, $V_{DS}=15\text{V}$, $I_D=6.9\text{A}$		13.84		nC
$Q_g(4.5\text{V})$	Total Gate Charge			6.74		nC
Q_{gs}	Gate Source Charge			1.82		nC
Q_{gd}	Gate Drain Charge			3.2		nC
$t_{D(on)}$	Turn-On Delay Time	$V_{GS}=10\text{V}$, $V_{DS}=15\text{V}$, $R_L=2.2\Omega$, $R_{GEN}=3\Omega$		4.6		ns
t_r	Turn-On Rise Time			4.1		ns
$t_{D(off)}$	Turn-Off Delay Time			20.6		ns
t_f	Turn-Off Fall Time			5.2		ns
t_{rr}	Body Diode Reverse Recovery Time	$I_F=6.9\text{A}$, $di/dt=100\text{A}/\mu\text{s}$		16.5		ns
Q_{rr}	Body Diode Reverse Recovery Charge	$I_F=6.9\text{A}$, $di/dt=100\text{A}/\mu\text{s}$		7.8		nC

A: The value of $R_{\theta JA}$ is measured with the device mounted on 1in² FR-4 board with 2oz. Copper, in a still air environment with $T_A=25^\circ\text{C}$. The value in any a given application depends on the user's specific board design. The current rating is based on the $t \leq 10\text{s}$ thermal resistance rating.

B: Repetitive rating, pulse width limited by junction temperature.

C. The $R_{\theta JA}$ is the sum of the thermal impedance from junction to lead $R_{\theta JL}$ and lead to ambient.

D. The static characteristics in Figures 1 to 6 are obtained using 80 μs pulses, duty cycle 0.5% max.

E. These tests are performed with the device mounted on 1 in² FR-4 board with 2oz. Copper, in a still air environment with $T_A=25^\circ\text{C}$. The SOA curve provides a single pulse rating.

P-Channel Electrical Characteristics ($T_J=25^\circ\text{C}$ unless otherwise noted)

Symbol	Parameter	Conditions	Min	Typ	Max	Units
STATIC PARAMETERS						
BV_{DSS}	Drain-Source Breakdown Voltage	$I_D=-250\mu\text{A}$, $V_{GS}=0\text{V}$	-30			V
I_{DSS}	Zero Gate Voltage Drain Current	$V_{DS}=-24\text{V}$, $V_{GS}=0\text{V}$ $T_J=55^\circ\text{C}$			-1 -5	μA
I_{GSS}	Gate-Body leakage current	$V_{DS}=0\text{V}$, $V_{GS}=\pm 20\text{V}$			± 100	nA
$V_{GS(th)}$	Gate Threshold Voltage	$V_{DS}=V_{GS}$, $I_D=-250\mu\text{A}$	-1.2	-2	-2.4	V
$I_{D(ON)}$	On state drain current	$V_{GS}=-10\text{V}$, $V_{DS}=-5\text{V}$	30			A
$R_{DS(ON)}$	Static Drain-Source On-Resistance	$V_{GS}=-10\text{V}$, $I_D=-6\text{A}$ $T_J=125^\circ\text{C}$		28 37	35 45	$\text{m}\Omega$
		$V_{GS}=-4.5\text{V}$, $I_D=-5\text{A}$		44	58	$\text{m}\Omega$
g_{FS}	Forward Transconductance	$V_{DS}=-5\text{V}$, $I_D=-6\text{A}$		13		S
V_{SD}	Diode Forward Voltage	$I_S=-1\text{A}$, $V_{GS}=0\text{V}$		-0.76	-1	V
I_S	Maximum Body-Diode Continuous Current				-4.2	A
DYNAMIC PARAMETERS						
C_{iss}	Input Capacitance			920		pF
C_{oss}	Output Capacitance	$V_{GS}=0\text{V}$, $V_{DS}=-15\text{V}$, $f=1\text{MHz}$		190		pF
C_{rss}	Reverse Transfer Capacitance			122		pF
R_g	Gate resistance	$V_{GS}=0\text{V}$, $V_{DS}=0\text{V}$, $f=1\text{MHz}$		3.6		Ω
SWITCHING PARAMETERS						
$Q_g(10\text{V})$	Total Gate Charge (10V)			18.5		nC
$Q_g(4.5\text{V})$	Total Gate Charge (4.5V)			9.6		nC
Q_{gs}	Gate Source Charge	$V_{GS}=-10\text{V}$, $V_{DS}=-15\text{V}$, $I_D=-6\text{A}$		2.7		nC
Q_{gd}	Gate Drain Charge			4.5		nC
$t_{D(on)}$	Turn-On Delay Time			7.7		ns
t_r	Turn-On Rise Time	$V_{GS}=-10\text{V}$, $V_{DS}=-15\text{V}$, $R_L=2.7\Omega$, $R_{GEN}=3\Omega$		5.7		ns
$t_{D(off)}$	Turn-Off Delay Time			20.2		ns
t_f	Turn-Off Fall Time			9.5		ns
t_{rr}	Body Diode Reverse Recovery Time	$I_F=-6\text{A}$, $dI/dt=100\text{A}/\mu\text{s}$		20		ns
Q_{rr}	Body Diode Reverse Recovery Charge	$I_F=-6\text{A}$, $dI/dt=100\text{A}/\mu\text{s}$		8.8		nC

A: The value of $R_{\theta JA}$ is measured with the device mounted on 1 in² FR-4 board with 2oz. Copper, in a still air environment with $T_A=25^\circ\text{C}$. The value in any a given application depends on the user's specific board design. The current rating is based on the $t \leq 10\text{s}$ thermal resistance rating.

B: Repetitive rating, pulse width limited by junction temperature.

C. The $R_{\theta JA}$ is the sum of the thermal impedance from junction to lead $R_{\theta JL}$ and lead to ambient.

D. The static characteristics in Figures 1 to 6,12,14 are obtained using 80 μs pulses, duty cycle 0.5% max.

E. These tests are performed with the device mounted on 1 in² FR-4 board with 2oz. Copper, in a still air environment with $T_A=25^\circ\text{C}$. The SOA curve provides a single pulse rating.

N-CHANNEL TYPICAL ELECTRICAL AND THERMAL CHARACTERISTICS

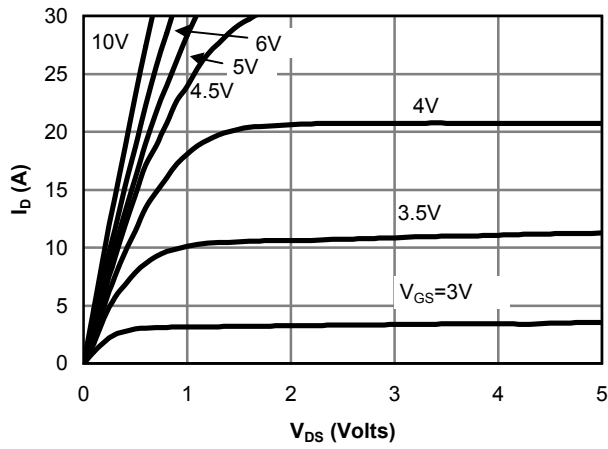

Fig 1: On-Region Characteristics

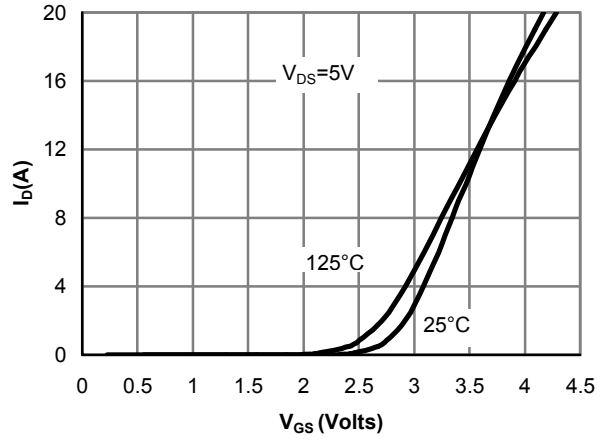

Figure 2: Transfer Characteristics

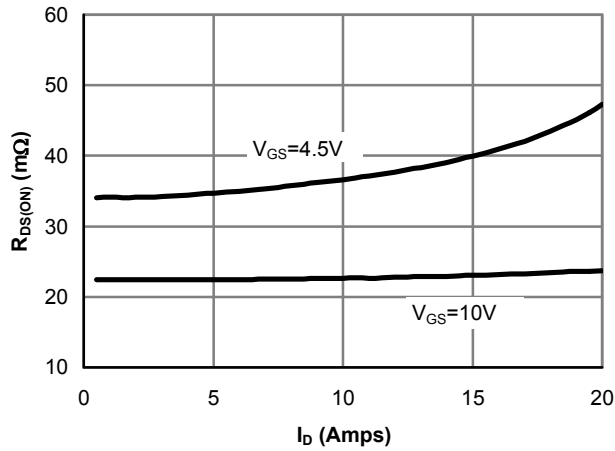

Figure 3: On-Resistance vs. Drain Current and Gate Voltage

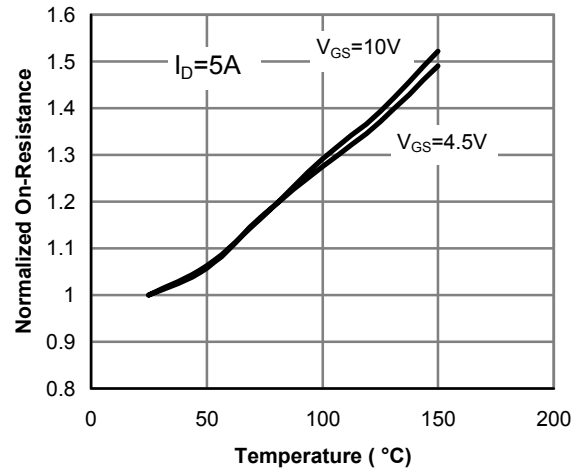

Figure 4: On-Resistance vs. Junction Temperature

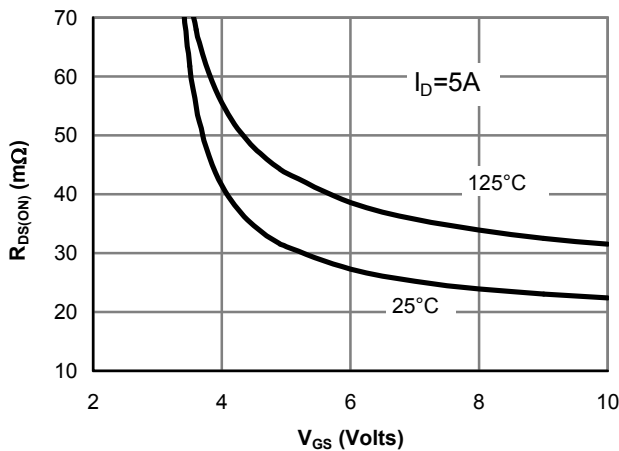

Figure 5: On-Resistance vs. Gate-Source Voltage

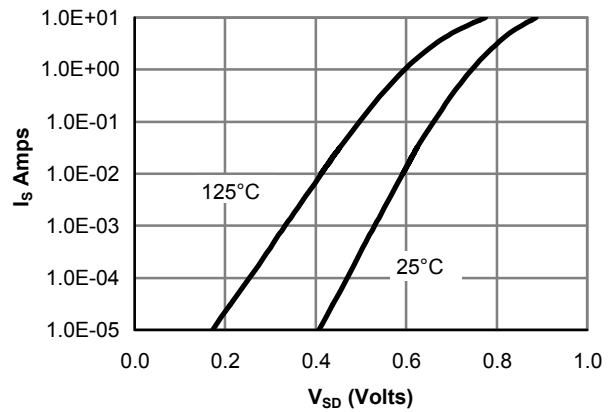

Figure 6: Body diode characteristics

N-CHANNEL TYPICAL ELECTRICAL AND THERMAL CHARACTERISTICS

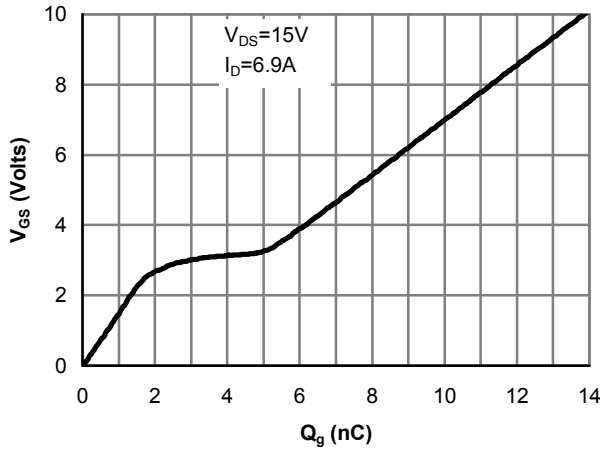

Figure 7: Gate-Charge characteristics

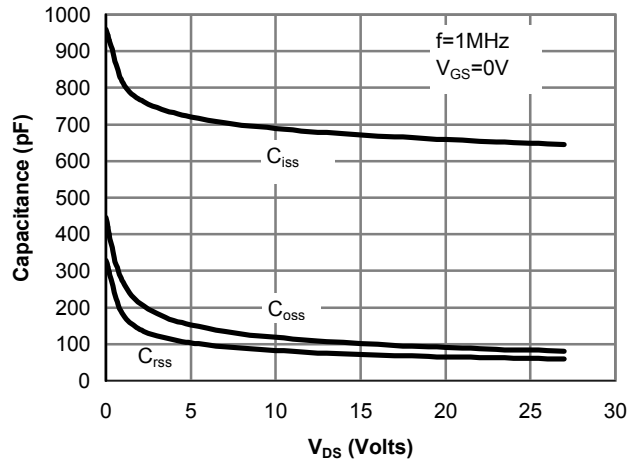

Figure 8: Capacitance Characteristics

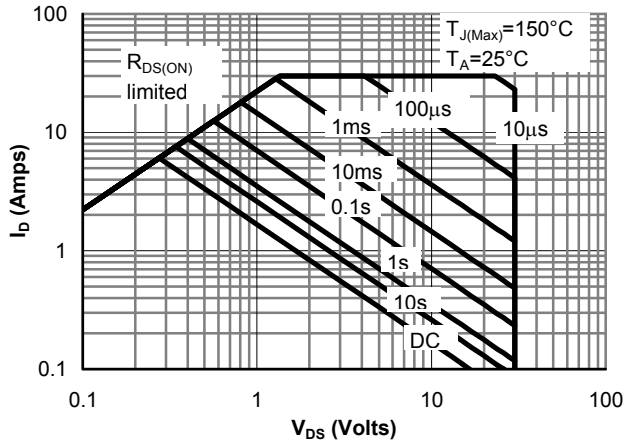

Figure 9: Maximum Forward Biased Safe Operating Area (Note E)

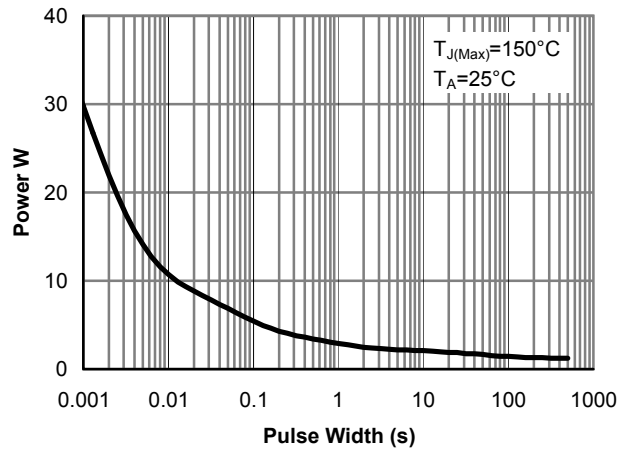

Figure 10: Single Pulse Power Rating Junction-to-Ambient (Note E)

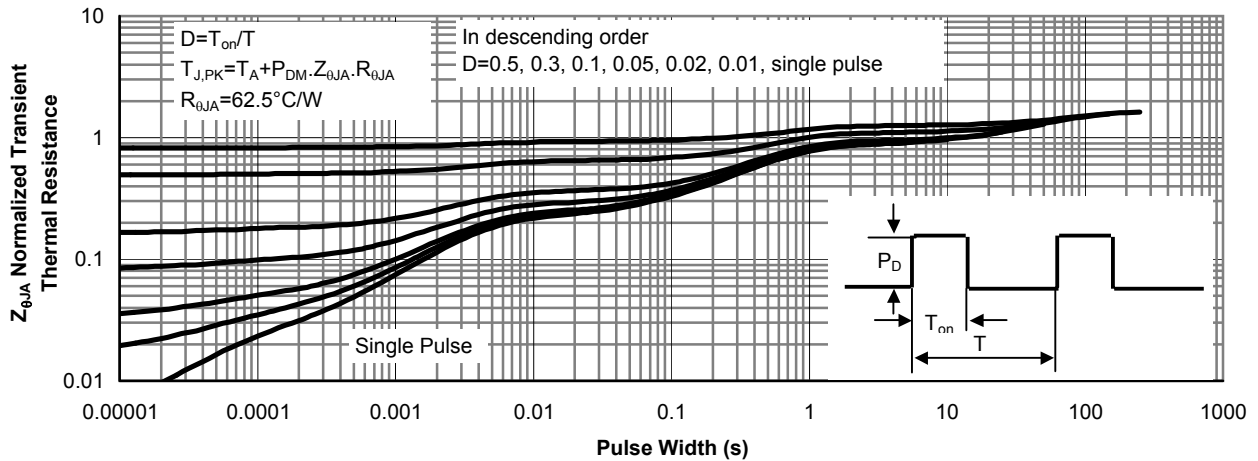

Figure 11: Normalized Maximum Transient Thermal Impedance

P-CHANNEL TYPICAL ELECTRICAL AND THERMAL CHARACTERISTICS

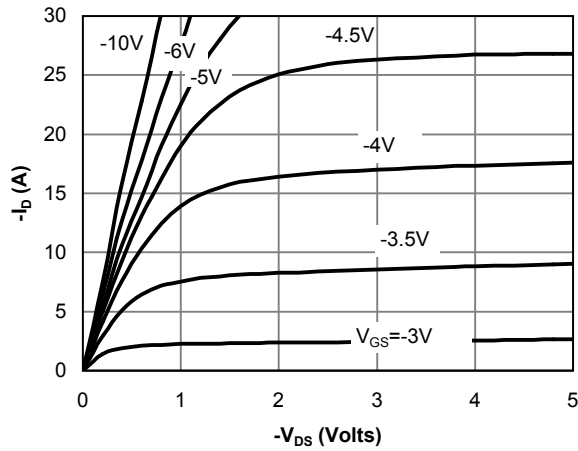

Fig 1: On-Region Characteristics

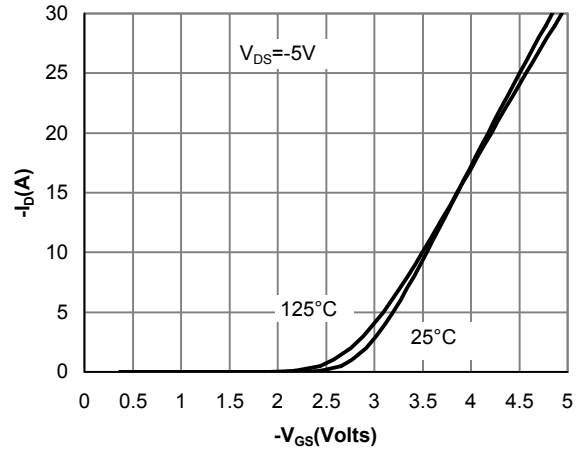

Figure 2: Transfer Characteristics

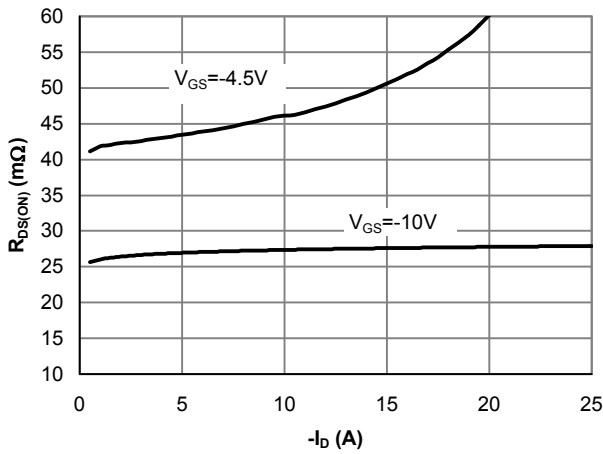

Figure 3: On-Resistance vs. Drain Current and Gate Voltage

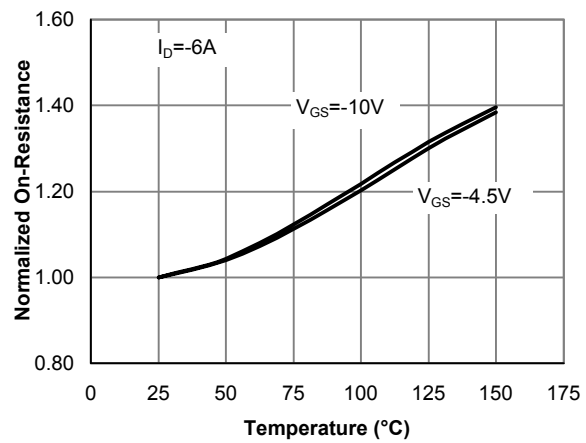

Figure 4: On-Resistance vs. Junction Temperature

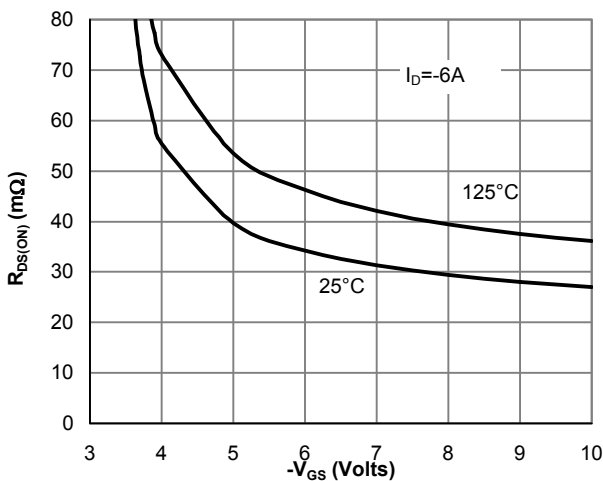

Figure 5: On-Resistance vs. Gate-Source Voltage

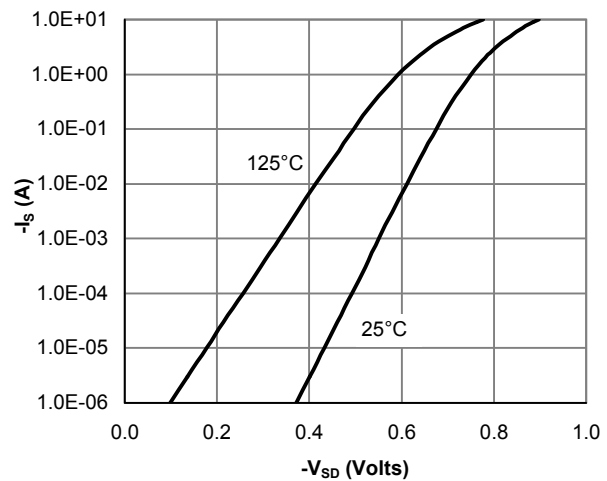

Figure 6: Body-Diode Characteristics

P-CHANNEL TYPICAL ELECTRICAL AND THERMAL CHARACTERISTICS

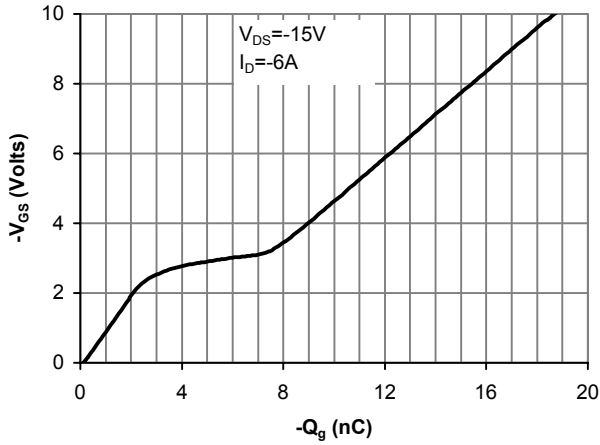

Figure 7: Gate-Charge Characteristics

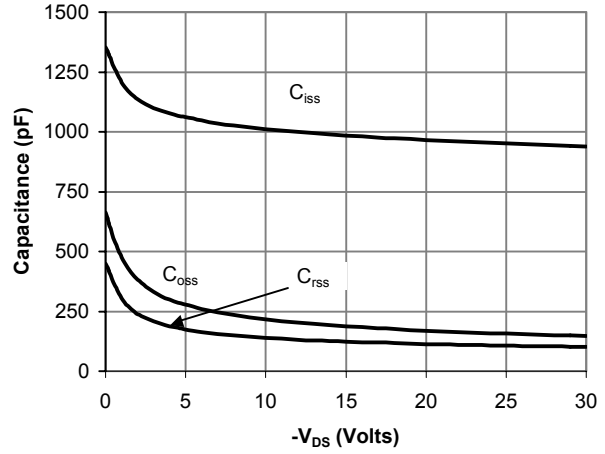

Figure 8: Capacitance Characteristics

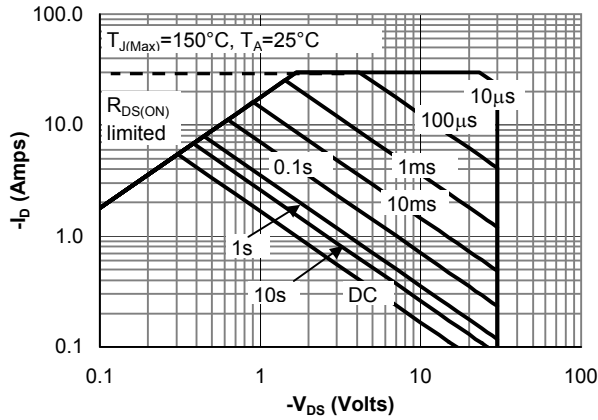

Figure 9: Maximum Forward Biased Safe Operating Area (Note E)

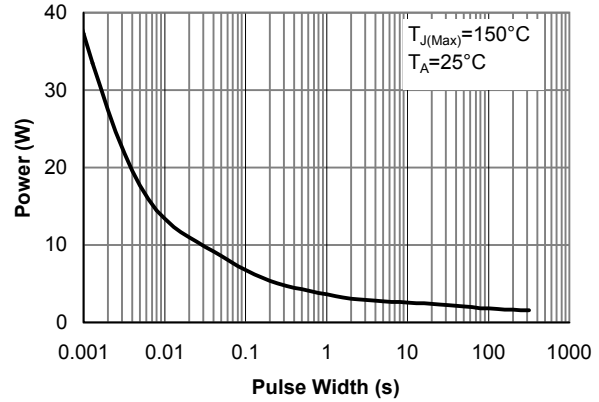

Figure 10: Single Pulse Power Rating Junction-to-Ambient (Note E)

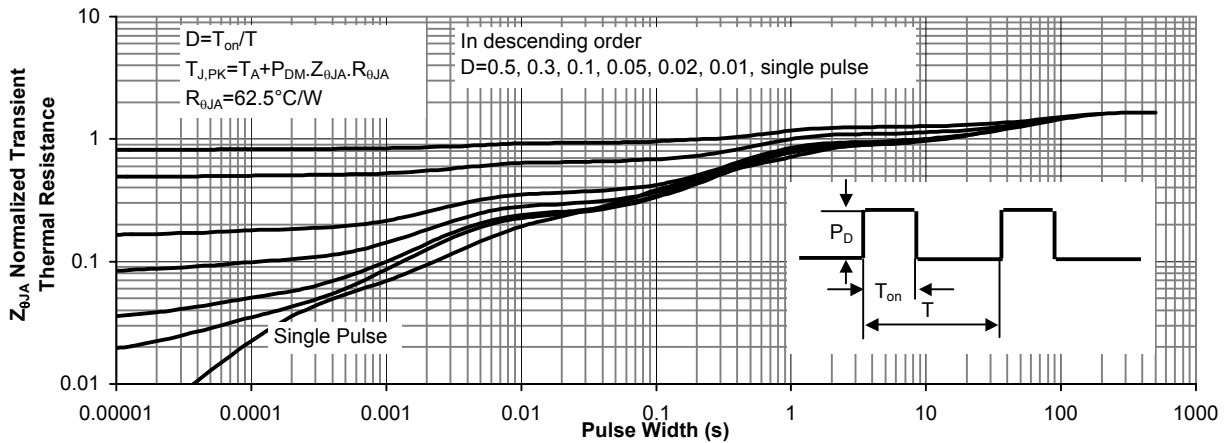
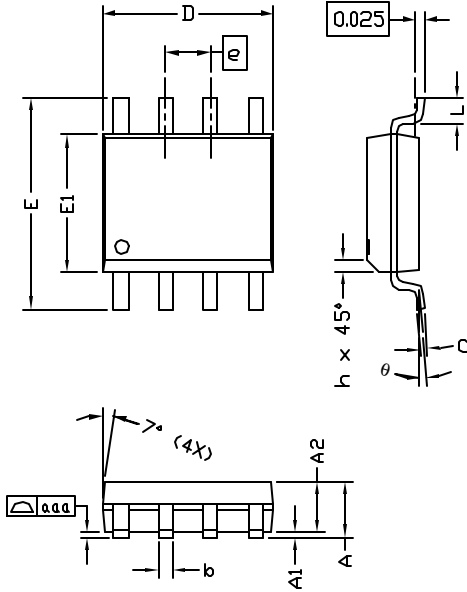

Figure 11: Normalized Maximum Transient Thermal Impedance



ALPHA & OMEGA
SEMICONDUCTOR, INC.

SO-8 Package Data



SYMBOLS	DIMENSIONS IN MILLIMETERS			DIMENSIONS IN INCHES		
	MIN	NOM	MAX	MIN	NOM	MAX
A	1.45	1.50	1.55	0.057	0.059	0.061
A1	0.00	—	0.10	0.000	—	0.004
A2	—	1.45	—	—	0.057	—
b	0.33	—	0.51	0.013	—	0.020
c	0.19	—	0.25	0.007	—	0.010
D	4.80	—	5.00	0.189	—	0.197
E1	3.80	—	4.00	0.150	—	0.157
e	1.27 BSC			0.050 BSC		
E	5.80	—	6.20	0.228	—	0.244
h	0.25	—	0.50	0.010	—	0.020
L	0.40	—	1.27	0.016	—	0.050
aaa	—	—	0.10	—	—	0.004
θ	0°	—	8°	0°	—	8°

NOTE:

- LEAD FINISH: 150 MICRONS (3.8 μm) MIN. THICKNESS OF Tin/Lead (SOLDER) PLATED ON LEAD
- TOLERANCE ±0.10 mm (4 mil) UNLESS OTHERWISE SPECIFIED
- COPLANARITY : 0.10 mm
- DIMENSION L IS MEASURED IN GAGE PLANE

PACKAGE MARKING DESCRIPTION



NOTE:

- LOGO - AOS LOGO
- 4606 - PART NUMBER CODE.
- F - FAB LOCATION
- A - ASSEMBLY LOCATION
- Y - YEAR CODE
- W - WEEK CODE.
- L C - ASSEMBLY LOT CODE

SO-8 PART NO. CODE

PART NO.	CODE
AO4606	4606

RECOMMENDED LAND PATTERN

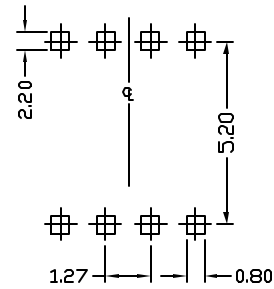

UNIT: mm



SO-8 Carrier Tape

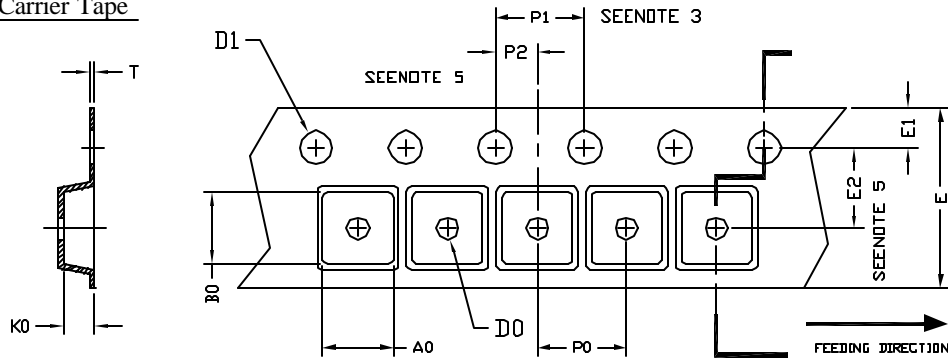

UNIT: MM

PACKAGE	A0	B0	K0	D0	D1	E	E1	E2	P0	P1	P2	T
SO-8 (12 mm)	6.40 ±0.10	5.20 ±0.10	2.10 ±0.10	1.60 ±0.10	1.30 ±0.10	12.00 ±0.30	1.75 ±0.10	5.50 ±0.05	8.00 ±0.10	4.00 ±0.10	2.00 ±0.05	0.25 ±0.05

SO-8 Reel

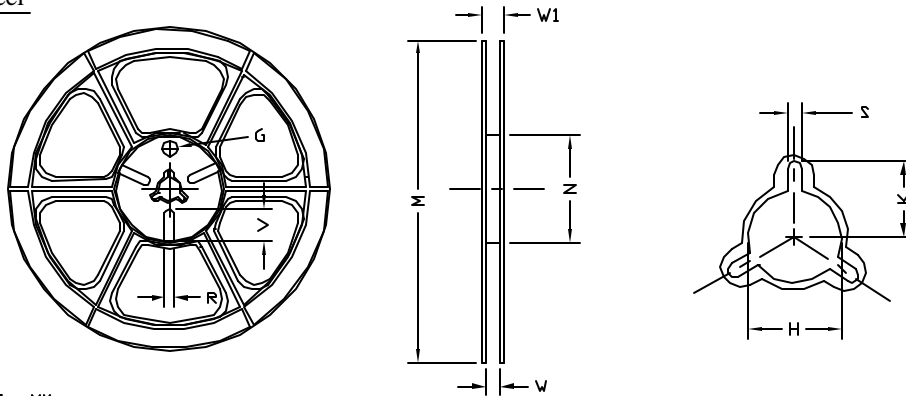

UNIT: MM

TAPE SIZE	REEL SIZE	M	N	W	W1	H	K	S	G	R	V
12 mm	φ330	φ330.00 ±0.50	φ97.00 ±0.10	13.00 ±0.30	17.40 ±1.00	φ13.00 +0.50 -0.20	10.60	2.00 ±0.50	---	---	---

SO-8 Tape

Leader / Trailer
& Orientation

