



BP3309 隔离 LED 电源 DEMO

1, 设计规格

输入电压: 85Vac ~ 265Vac; 47Hz ~ 63Hz

输出电压: 16V ~ 22V (5~7 串 LED)

输出电流: 330mA

电源尺寸: 45*22*19mm (长、宽、高)

引线方式: 接线

2, 评估结果

测试参数	测试结果	备注
线性调整率	±1%	Load: 7 串 LED
负载调整率	±0.6%	5~7 串 LED @110Vac
	±0.2%	5~7 串 LED @220Vac
效率	84.2%	7 串 LED @110Vac
	86.5%	7 串 LED @220Vac
PF	0.992	7 串 LED @ 110Vac
	0.931	7 串 LED @ 220Vac
启动时间	150mS	7 串 LED @85Vac
EMI	7.2dB Margin	传导测试
	5.8dB Margin	辐射测试
LED 短路保护	OK	
LED 开路保护	OK	

3, 电气特性测试结果

3.1 线性调整率和负载调整率

LED	输出电压 (V)	输出电流 (mA)						线性调整率
		85Vac	110Vac	132Vac	176Vac	220Vac	265Vac	
5 * 1W	16.0	328	326	326	326	329	331	±0.8%
6 * 1W	19.2	331	329	327	327	328	330	±0.6%
7 * 1W	22.4	334	330	329	327	328	329	±1.0%
负载调整率		±0.9%	±0.6%	±0.5%	±0.2%	±0.2%	±0.3%	



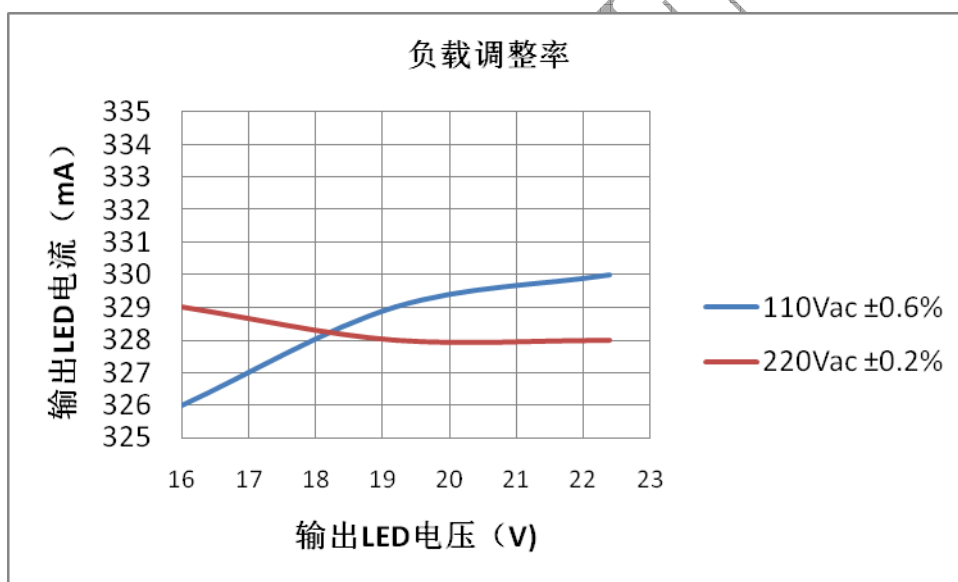
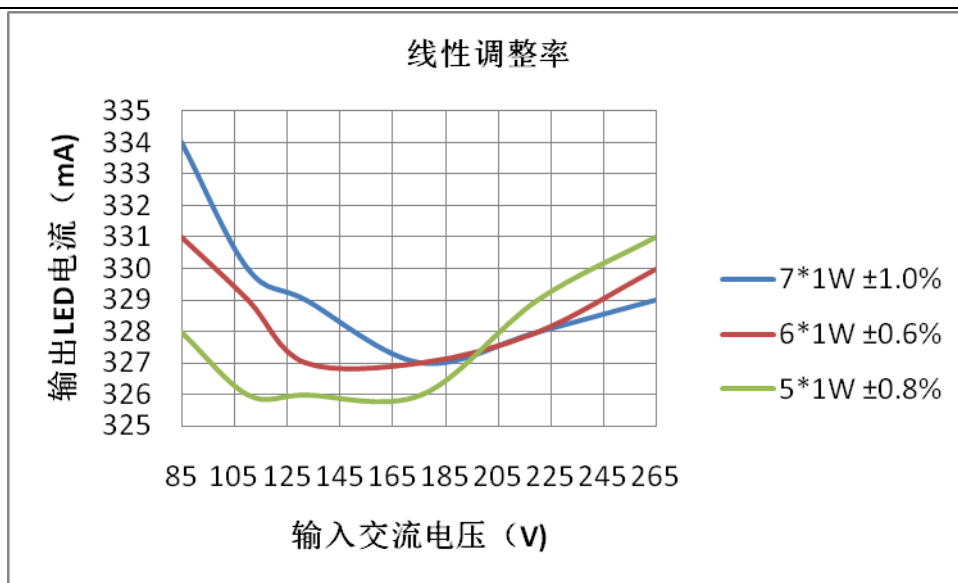

3.2. 效率

输入电压	效率 (%)		
	5 * 1W	6 * 1W	7 * 1W
110Vac	84.1	84.3	84.2
220Vac	84.9	85.8	86.5

3.3 PF 值

LED	PF					
	85Vac	110Vac	132Vac	176Vac	220Vac	265Vac
5 * 1W	0.995	0.99	0.982	0.957	0.918	0.882
6 * 1W	0.996	0.992	0.985	0.967	0.934	0.904
7 * 1W	0.996	0.992	0.986	0.964	0.931	0.902



3.4 启动时间测试

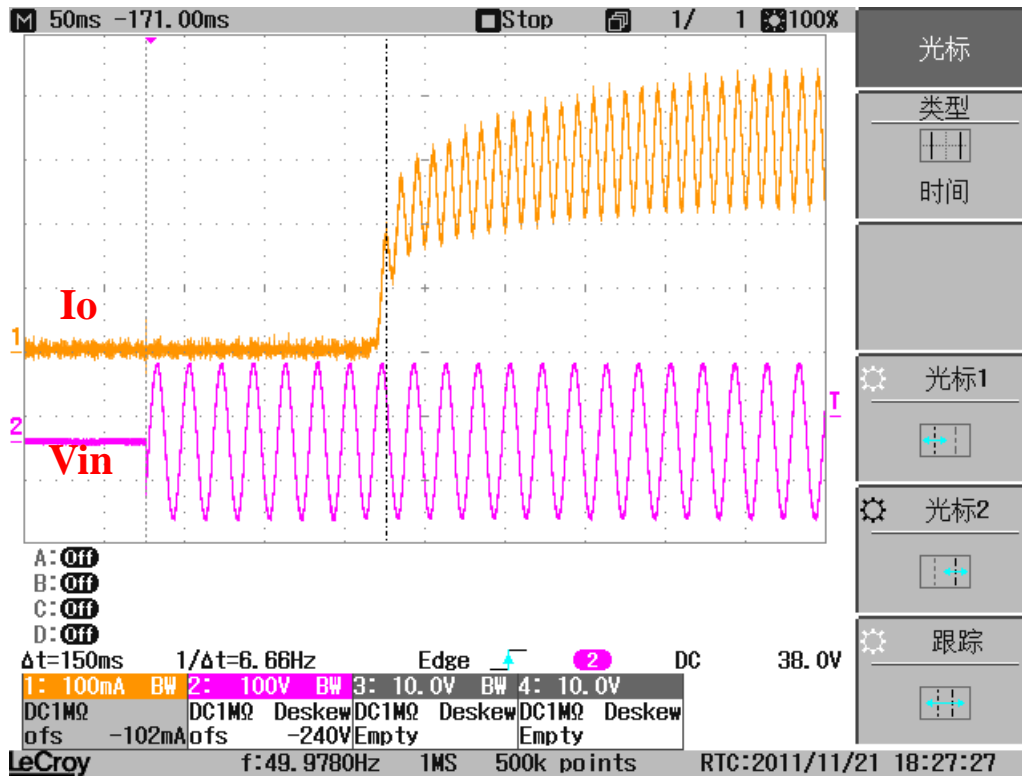

4, 温升测试

环境温度 (°C)	81			
位置	变压器铁芯	变压器线包	输出整流二极管	功率 MOSFET
元件温度 (°C)	93.9	104.1	91.4	107.2
元件温升 (°C)	12.9	23.1	10.4	26.2





5, EMI 测试

5.1 传导测试



Audix Technology (Shanghai) Co., Ltd.
3F #34Bldg. No.680 GuiPing Rd.,
CaoHeJing Hi-Tech Park,
Shanghai 200233, China
Tel:+86-21-64955500 Fax:+86-21-64955491
audixaci@audix.com

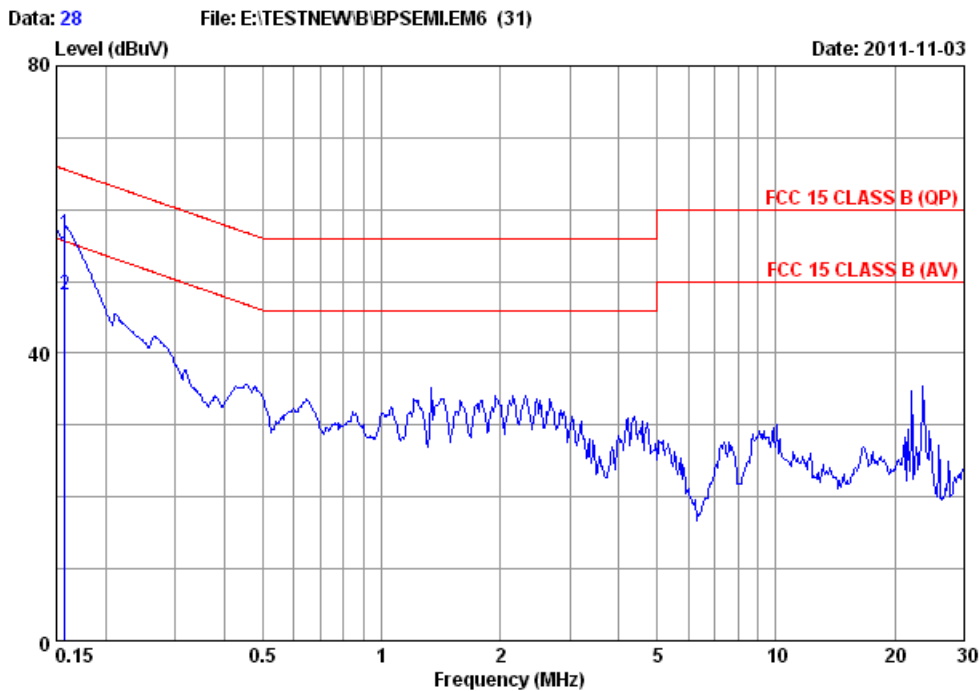

Site no : Audix(Shanghai) Shielded1 Data no :28
AMN : ENV4200-11.03.22 AMN Phase :NEUTRAL
Limit : FCC 15 CLASS B (QP)
Env/Ins : 22'C 48%RH / ESCI Engineer :Lvy
EUT : LED
M/N : BULB-683
S/N : 1#
Power Rating : 120V/60Hz
Test Mode : Lighting

	Freq (MHz)	AMN. Factor (dB)	Cable Loss (dB)	Reading (dBuV)	Emission Level (dBuV)	Limits (dBuV)	Margin (dB)	Remark
1	0.157	9.86	0.03	46.60	56.49	65.60	9.11	QP
2	0.157	9.86	0.03	38.20	48.09	55.60	7.51	Average

Remarks:1.Emission Level= AMN Factor + Cable Loss + Reading.



Audix Technology (Shanghai) Co., Ltd.
3F #34Bldg. No.680 GuiPing Rd.,
CaoHeJing Hi-Tech Park,
Shanghai 200233, China
Tel:+86-21-64955500 Fax:+86-21-64955491
audixaci@audix.com

Data: 29 File: E:\TESTNEW\B\BPSEMI\EM6 (31)

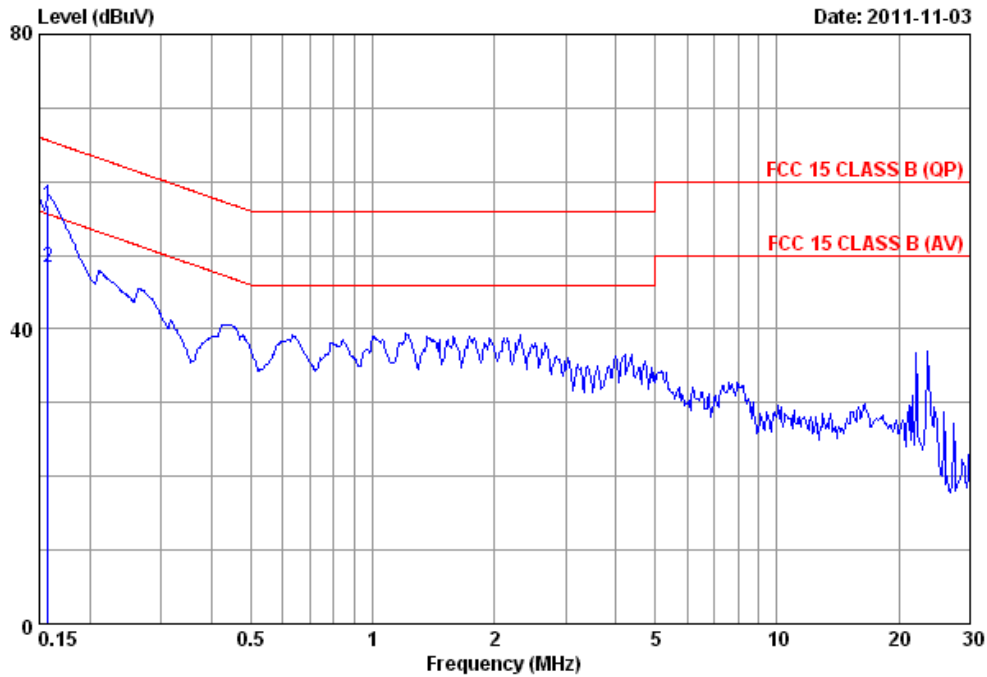

Site no : Audix(Shanghai) Shielded1 Data no : 29
AMN : ENV4200-11.03.22 AMN Phase : LINE
Limit : FCC 15 CLASS B (QP)
Env/Ins : 22'C 48%RH / ESCI Engineer : Lvy
EUT : LED
M/N : BULB-683
S/N : 1#
Power Rating : 120V/60Hz
Test Mode : Lighting

	Freq (MHz)	AMN. Factor (dB)	Cable Loss (dB)	Reading (dBuV)	Emission Level (dBuV)	Limits (dBuV)	Margin (dB)	Remark
1	0.157	9.86	0.03	47.00	56.89	65.60	8.71	QP
2	0.157	9.86	0.03	38.50	48.39	55.60	7.21	Average

Remarks:1.Emission Level= AMN Factor + Cable Loss + Reading.



5.2 辐射测试



Audix Technology (Shanghai) Co., Ltd.
3F #34Bldg. No.680 GuiPing Rd.,
CaoHeJing Hi-Tech Park,
Shanghai 200233, China
Tel:+86-21-64955500 Fax:+86-21-64955491
audixaci@audix.com

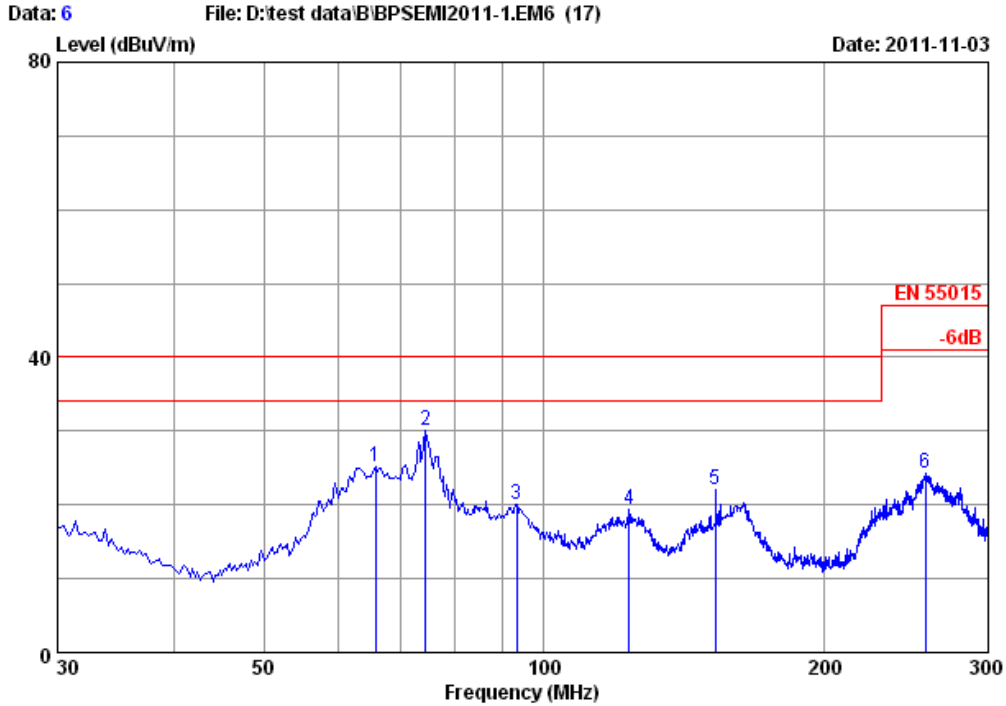

Site : Audix(Shanghai) Chamber3
Condition : EN 55015 HORIZONTAL
Project No. :
Applicant :
EUT : LED 12S24PT
M/N :
S/N :
Power Supply : 230V/50Hz
Ambient : 22'C 60%RH
Test Mode : WORKING
Test Engineer: Raven
Memo : 6*1 BULB

	Read	Antenna	Cable	Limit	Over		
Freq	Level	Level	Factor	Loss	Line	Limit	
MHz	dBuV/m	dBuV	dB/m	dB	dBuV/m	dB	
1	65.910	25.20	42.16	9.55	1.32	40.00	-14.80 Peak
2	74.550	30.16	46.29	10.21	1.51	40.00	-9.84 Peak
3	93.450	20.15	35.14	11.13	1.77	40.00	-19.85 Peak
4	123.420	19.31	33.99	10.94	2.05	40.00	-20.69 Peak
5	152.850	22.09	37.00	10.36	2.24	40.00	-17.91 Peak
6	256.800	24.33	36.30	12.27	2.63	47.00	-22.67 Peak



Audix Technology (Shanghai) Co., Ltd.
3F #34Bldg. No.680 GuiPing Rd.,
CaoHeJing Hi-Tech Park,
Shanghai 200233, China
Tel:+86-21-64955500 Fax:+86-21-64955491
audixaci@audix.com

Data: 7 File: D:\test data\B\BPSEMI2011-1.EM6 (17)

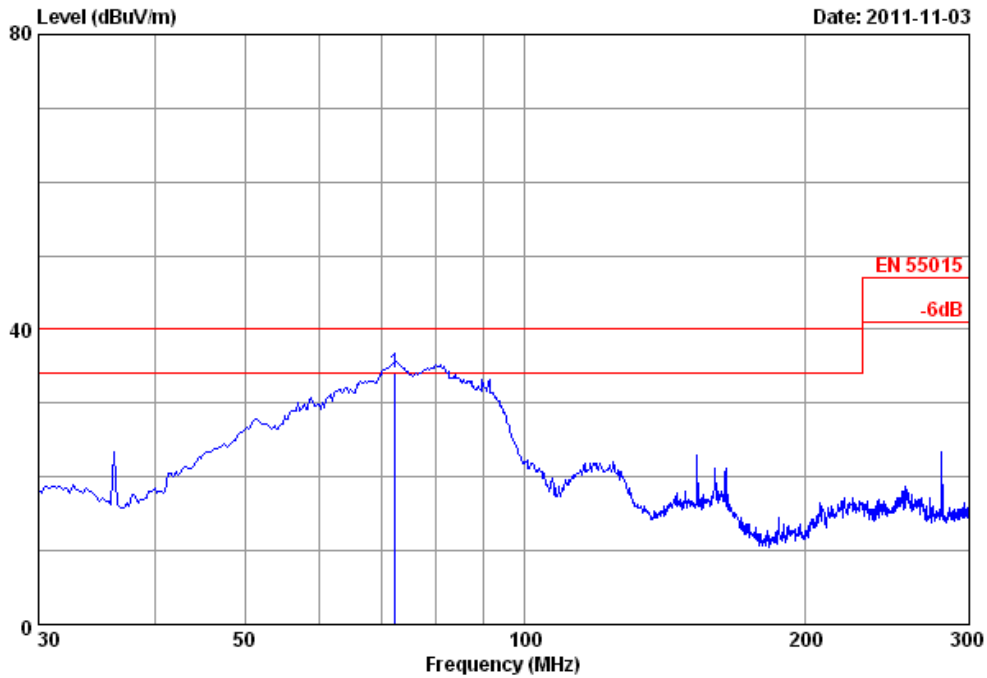

Site : Audix(Shanghai) Chamber3
Condition : EN 55015 VERTICAL
Project No. :
Applicant :
EUT : LED 12S24PT
M/N :
S/N :
Power Supply : 230V/50Hz
Ambient : 22'C 60%RH
Test Mode : WORKING
Test Engineer: Raven
Memo : 6*1 BULB

Freq	Level	ReadAntenna	Cable	Limit	Over	
MHz	dBuV/m	Level	Factor	Loss	Line	Limit Remark
		dBuV	dB/m	dB	dBuV/m	dB
1 !	72.560	34.16	22.63	10.06	1.47	40.00 -5.84 QP





上海晶丰明源半导体有限公司
Bright Power Semiconductor



Audix Technology (Shanghai) Co., Ltd.
3F #34Bldg. No.680 GuiPing Rd.,
CaoHeJing Hi-Tech Park,
Shanghai 200233, China
Tel:+86-21-64955500 Fax:+86-21-64955491
audixaci@audix.com

Data: 8 File: D:\test data\B\BPSEMI2011-1.EM6 (17)

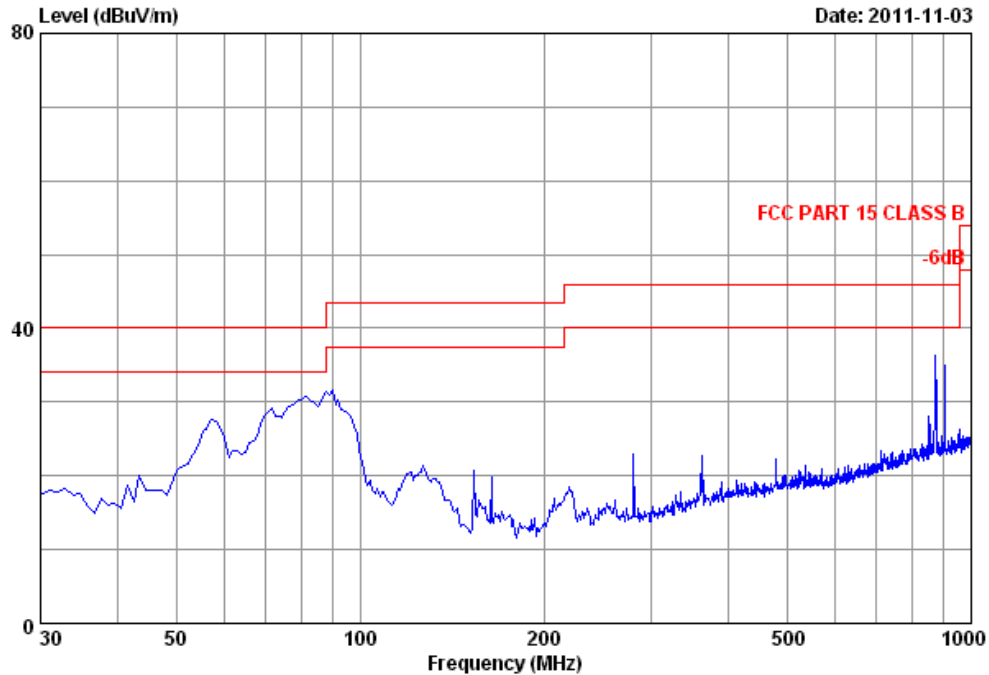

Site : Audix(Shanghai) Chamber3
Condition : FCC PART 15 CLASS B VERTICAL
Project No. :
Applicant :
EUT : LED 12S24PT
M/N :
S/N :
Power Supply : 120V/60Hz
Ambient : 22'C 60%RH
Test Mode : WORKING
Test Engineer: Raven
Memo : 6*1 BULB



上海晶丰明源半导体有限公司
Bright Power Semiconductor

Add: 上海市张江高科技园区毕升路 299 弄 6 号 502 室

Tel: (86) 21-51870166

Fax: (86)21-5027 5095

Web: www.bpsemi.com



上海晶丰明源半导体有限公司
Bright Power Semiconductor



Audix Technology (Shanghai) Co., Ltd.
3F #34Bldg. No.680 GuiPing Rd.,
CaoHeJing Hi-Tech Park,
Shanghai 200233, China
Tel:+86-21-64955500 Fax:+86-21-64955491
audixaci@audix.com

Data: 9 File: D:\test data\B\BPSEMI2011-1.EM6 (17)

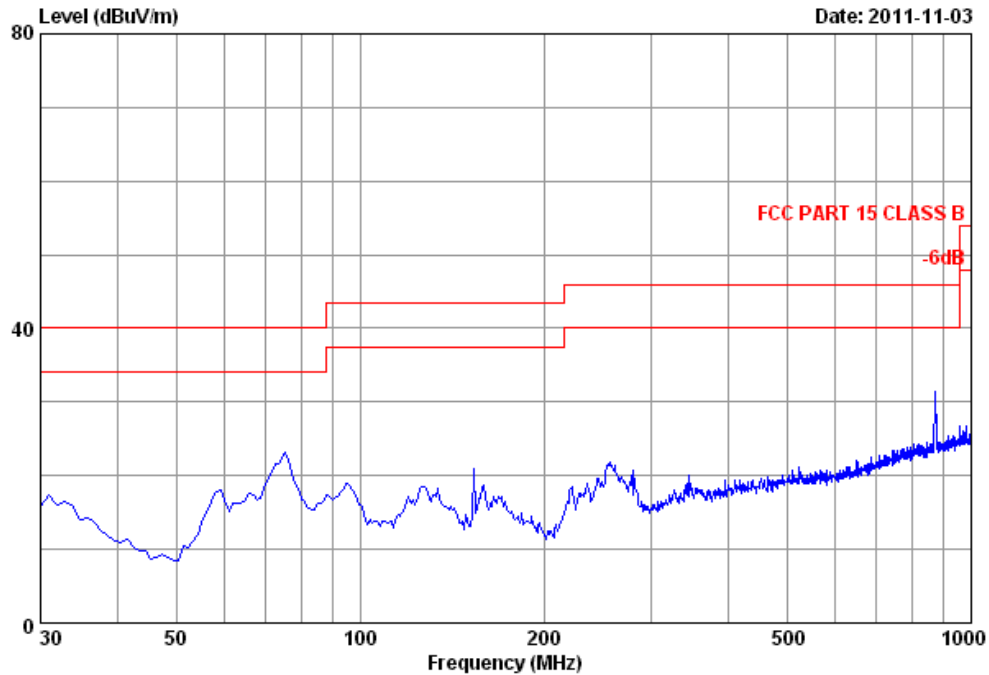

Site : Audix(Shanghai) Chamber3
Condition : FCC PART 15 CLASS B HORIZONTAL
Project No. :
Applicant :
EUT : LED 12S24PT
M/N :
S/N :
Power Supply : 120V/60Hz
Ambient : 22'C 60%RH
Test Mode : WORKING
Test Engineer: Raven
Memo : 6*1 BULB



上海晶丰明源半导体有限公司
Bright Power Semiconductor

Add: 上海市张江高科技园区毕升路 299 弄 6 号 502 室

Tel: (86) 21-51870166

Fax: (86)21-5027 5095

Web: www.bpsemi.com



6, 应用原理图

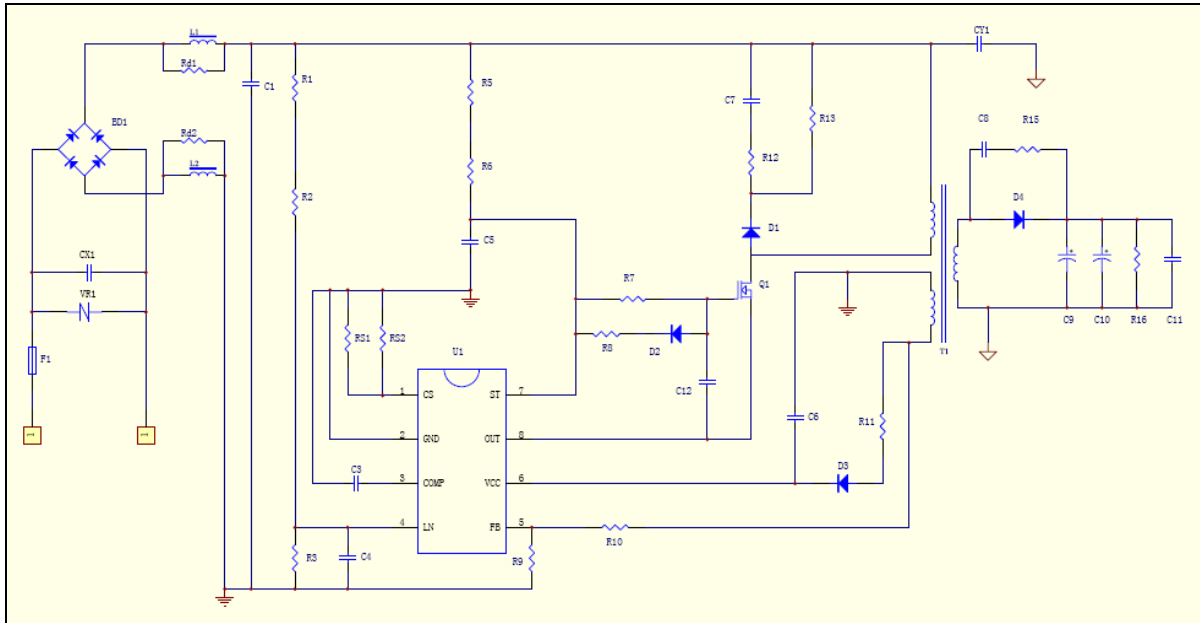

BPS CONFIDENTIAL

