

5:1 Intermediate Bus Converter Module: Up to 850 W Output IB050Q096T80N1-00



Size:
2.30 x 1.45 x 0.42 in
58,4 x 36,8 x 10,6 mm



Applications

- Enterprise networks
- Optical access networks
- Storage networks
- Automated test equipment

Features

- Input: 36 – 60 Vdc
- Output: 9.6 Vdc at 48 Vin
- Output current: up to 80 A
- Output power: up to 850 W
- 2,250 Vdc isolation
- 98.1% peak efficiency
- Low profile: 0.42" height above board
- Industry standard 1/4 Brick pinout
- Sine Amplitude Converter
- Low noise 1 MHz ZVS/ZCS

Product Overview

The Intermediate Bus Converter (IBC) Module is a very efficient, low profile, isolated, fixed ratio converter for power system applications in enterprise and optical access networks. Rated at up to 550 W from 36 Vin and up to 850 W from 55 to 60 Vin, the IBC conforms to an industry standard quarter-brick footprint while supplying power greatly exceeding competitive quarter-bricks. Its leading efficiency enables full load operation at 50°C with only 400 LFM airflow. Its small cross section facilitates unimpeded airflow — above and below its thin body — to minimize the temperature rise of downstream components. A baseplate option is available for alternative cooling schemes.

Absolute Maximum Ratings

	Min	Max	Unit	Notes
Input voltage (+In to -In)				
Operating	36	60	Vdc	
Non-operating		75	Vdc	<100 mS
Input voltage slew rate		5	V/μs	
EN to -IN	-0.5	20	Vdc	
Output voltage (+Out to -Out)	-0.5	13.8	Vdc	
Output current		80	A	Pout ≤ 850 W
Dielectric withstand (input to output)	2,250		Vdc	1 min.
Temperature				
Operating junction	-40	125	°C	Hottest Semiconductor
Storage	-55	125	°C	

SPECIFICATIONS

All specifications valid at 48 V_{IN}, 100% rated load and 25°C ambient, unless otherwise indicated.

Electrical Characteristics						
Attribute	Symbol	Conditions / Notes	Min	Typ	Max	Unit
INPUT (Operating from DC input source)						
Operating input voltage			36	48	60	Vdc
Non-operating input surge withstand		<100 mS			75	Vdc
Operating input dV/dt			0.003		5	V/us
Undervoltage protection						
Turn-on			31		36	Vdc
Turn-off			29		34	Vdc
Turn-on/Turn-off hysteresis			2			Vdc
Time constant					7	µs
Undervoltage blanking time		UV blanking time is enabled after start up	50	100	200	µs
Overvoltage protection						
Turn-off			65		69	Vdc
Turn-on			60		69	Vdc
Time constant					4	µs
Turn ON delay						
Start up inhibit		V _{IN} reaching turn-on voltage to enable function operational, see Figure 6	20	25	30	ms
Turn-on delay		Enable to 10% V _{OUT} ; pre-applied V _{IN} , see Figure 7, 0 load capacitance			50	µs
Output voltage rise time		From 10% to 90% V _{OUT} , 10% load, 0 load capacitance			50	µs
Restart turn-on delay		See page 10 for restart after EN pin disable			250	ms
No Load power dissipation						
Enabled				3.1	4.5	W
Disabled				0.12	0.15	W
Input current		Low line, full load			16.1	A
Inrush current overshoot		Using test circuit in Figure 21, 15% load, high line			16.8	A
Input reflected ripple current		At max power; Using test circuit in Figure 22; see Fig 5			850	mArms
Peak short circuit input current					65	A
Repetitive short circuit peak current					25	A
Internal input capacitance				17.6		µF
Internal input inductance				5		nH
Recommended external input capacitance		200 nH maximum source inductance	47		470	µF
OUTPUT						
DC Output voltage band		No load, over Vin range	7.2	9.6	12.0	V
Output power [a]						
36-60 V _{IN}			0		550	W
48-60 V _{IN}			0		750	W
55-60 V _{IN}			0		850	W
Output current		P ≤ 850 W			80	A
Output start up load		of I _{out} max, maximum output capacitance			15	%
Effective output resistance				2.4		mΩ
Line regulation (K factor)		V _{OUT} = K • V _{IN} @ no load	0.198	0.200	0.2020	
Current share accuracy		Full power operation; See Parallel Operation on page 11; up to 3 units			10	%

[a] Does not exceed IPC-9592 derating guidelines. At 70°C ambient, full power operation may exceed IPC-9592 guidelines, but does not exceed component ratings, does not activate OTP and does not compromise reliability.

SPECIFICATIONS (CONT.)

All specifications valid at 48 V_{IN}, 100% rated load and 25°C ambient, unless otherwise indicated.

Electrical Characteristics (Continued)						
Attribute	Symbol	Conditions / Notes	Min	Typ	Max	Unit
OUTPUT (Continued)						
Efficiency						
50% load		See Figure 1,2 and 3	97.9	98.1		%
Full load		See Figure 1,2 and 3	97.0	97.4		%
Internal output inductance				1.6		nH
Internal output capacitance				92.4		μF
Load capacitance			0		4500	μF
Output OVP set point		Module will shutdown	12			Vdc
Output voltage ripple		20 MHz bandwidth, using test circuit in Figure 23		60	150	mVp-p
Output Overload protection threshold		Of lout max., will not shutdown when started into max Cout; and 15% load Auto restart with duty cycle <10%	105		150	%
Over current protection time constant					1.2	ms
Short circuit current response time					1.5	μs
Switching frequency				1.0		MHz
Transient Response						
Voltage overshoot		25% load step; See Figures 13 & 14, using test circuit in Figure 24			100	mV
Response time		See Figures 13 & 14, using test circuit in Figure 24		1		μs
V _{IN} step		5 V step in 1 μs within Vin operating range			1.25	V
Pre-bias voltage		Unit will start up into pre-bias voltage on output	0		12	Vdc

General Characteristics						
Conditions: 25°C case, 75% rated load and specified input voltage range unless otherwise specified.						
Attribute	Symbol	Conditions / Notes	Min	Typ	Max	Unit
MTBF		Calculated per Telcordia SR-332, 40°C	1.0			Mhrs
Service life		Calculated at 30°C	7			Years
Over temperature shut down		T _J ; Converter will reset when over temperature condition is removed	125	130	135	°C
Dielectric withstand		Input to output	2,250			Vdc
Insulation resistance		Input to output		30		MΩ
Mechanical						
Weight				1.38 / 39.1		oz/g
Length				2.30 / 58.4		in/mm
Width				1.45 / 36.8		in/mm
Height above customer board				0.42 / 10.6		in/mm
Clearance to customer board		From lowest component on IBC	0.12 / 0.30			in/mm
Agency approvals (pending)		UL/CSA 60950-1, EN60950-1 Low voltage directive (2006/95/EC)				cTUVus CE
Altitude, operating		Derate operating temp 1°C per 1,000 feet above sea level	-500		10,000	Feet
Relative humidity, Operating		Non condensing	10		90	%
RoHS compliance		Compatible with RoHS directive 2002/95/EC				

SPECIFICATIONS (CONT.)

Control & Interface Specifications

Attribute	Symbol	Conditions / Notes	Min	Typ	Max	Unit
Enable (negative logic)		Referenced to -IN				
Module enable threshold			0.8			Vdc
Module enable current		$V_{EN} = 0.8\text{ V}$		130	200	μA
Module disable threshold					2.4	Vdc
Module disable current		$V_{EN} = 2.4\text{ V}$			10	μA
Disable hysteresis				500		mV
Enable pin open circuit voltage				2.5	3.0	Vdc
EN to -IN resistance		Open circuit		35		k Ω
Enable (positive logic)		Referenced to -IN				
Module enable threshold			2.0	2.5	3.0	Vdc
Module disable threshold					1.45	Vdc
EN source current (operating)		$V_{EN} = 5\text{ V}$			2	mA
EN voltage (operating)			4.7	5	5.3	Vdc

IPC-9592A, Based on Class II Category 2 the following detail is applicable. – Pre-conditioning required

Environmental Qualification

Test Description	Test Detail	Quantity Tested
5.2.3 HALT (Highly Accelerated Life testing)	Low Temp	3
	High Temp	3
	Rapid Thermal Cycling	3
	6 DOF Random Vibration Test	3
	Input Voltage Test	3
	Output Load Test	3
	Combined Stresses Test	3
5.2.4 THB (Temp. Humidity Bias)	(72 hr presoak required) 1000 hrs – Continuous Bias	30
5.2.5 HTOB (High Temp. Operating Bias)	Power cycle - On 42 minutes Off 1 minute, On 1 minute, Off 1 minute, On 1 minute, Off 1 minute, On 1 minute, Off 1 minute, On 1 minute, Off 10 minutes. Alternating between maximum and minimum operating Voltage every hour.	30
5.2.6 TC (Temp. Cycling)	700 cycles , 30 minute dwell at each extreme – 20C minimum ramp rate.	30
5.2.7 Power Cycling	Reference IPC-9592A	3
5.2.8 – 5.2.13 Shock and Vibration	Random Vibration – Operating IEC 60068-2-64 (normal operation vibration)	3
	Random Vibration Non-operating (transportation) IEC 60068-2-64	3
	Shock Operating - normal operation shock IEC 60068-2-27	3
	Free fall - IEC 60068-2-32	3
	Drop Test 1 full shipping container (box)	12
5.2.14 Other Environmental Tests	5.2.14.1 Corrosion Resistance – Not required	N/A
	5.2.14.2 Dust Resistance – Unpotted class II GR-1274-CORE	3
	5.2.14.3 SMT Attachment Reliability IPC-9701 - J-STD-002	3
	5.2.14.4 Through Hole solderability – J-STD-002	5
ESD Classification Testing	Sample size assumes CDM testing	12
Total Quantity		161

SPECIFICATIONS (CONT.)

WAVEFORMS

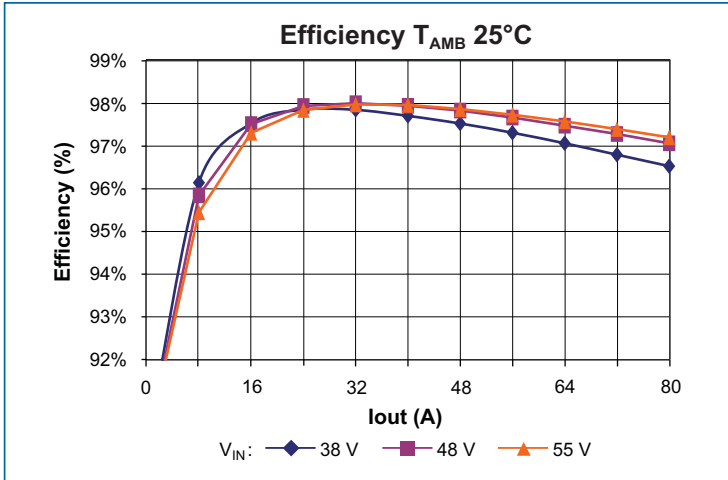

Figure 1 — Efficiency vs. output current, 25°C ambient

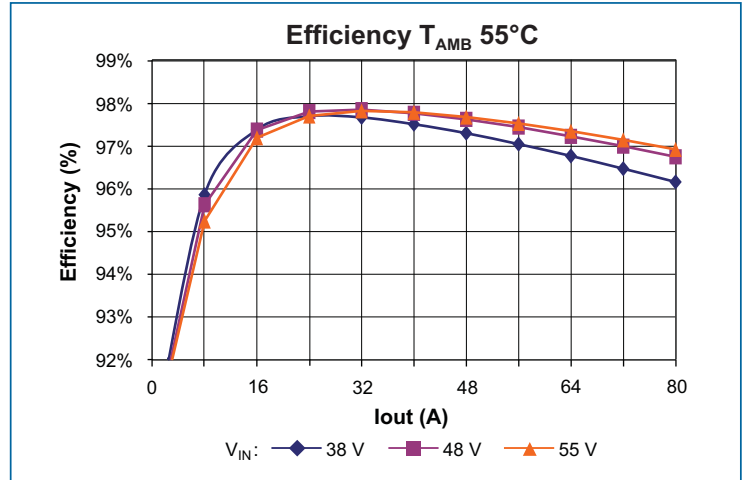

Figure 2 — Efficiency vs. output current, 55°C ambient

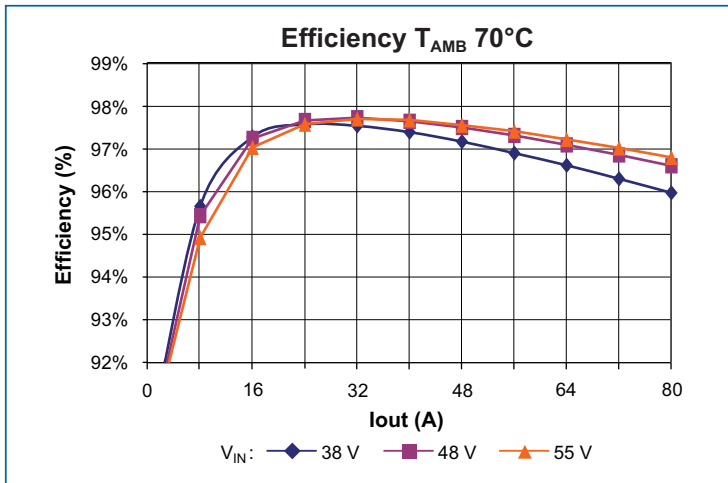

Figure 3 — Efficiency vs. output current, 70°C ambient

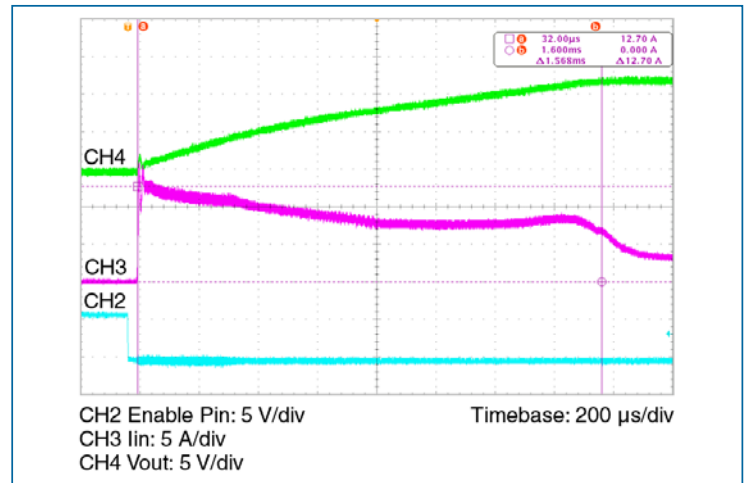

Figure 4 — Inrush current at high line 15% load; 5 A/div, Max load capacitance

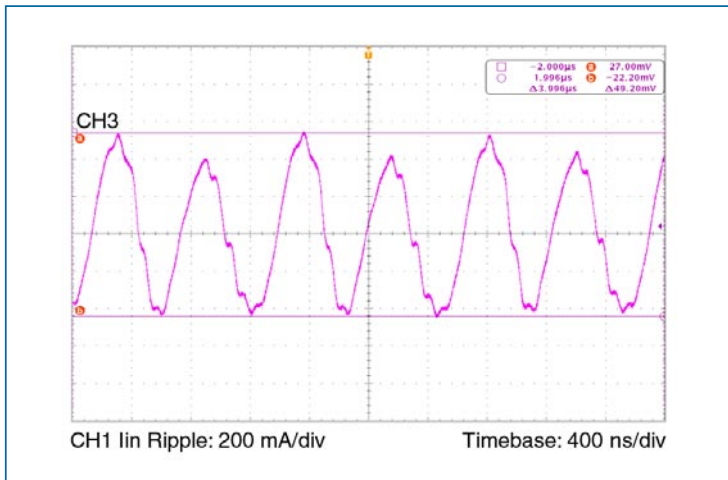

Figure 5 — Input reflected ripple current at nominal line, full load. See Fig 22 for setup.

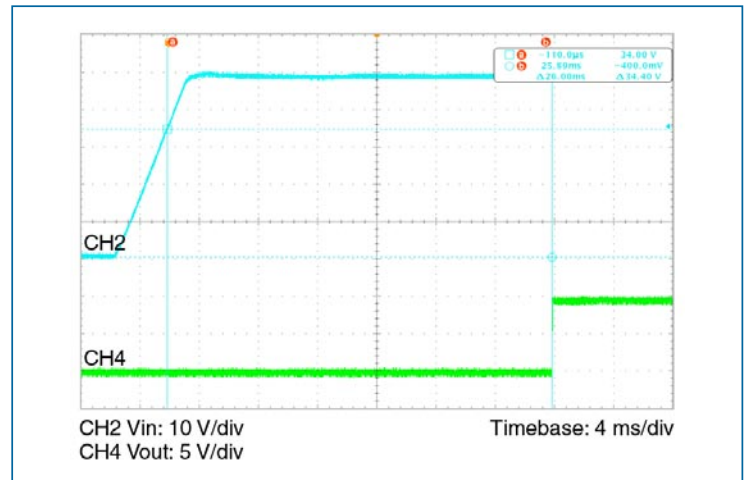

Figure 6 — Turn on delay time; V_{IN} turn on delay at nominal line, 15% load

SPECIFICATIONS (CONT.)

WAVEFORMS (CONT.)

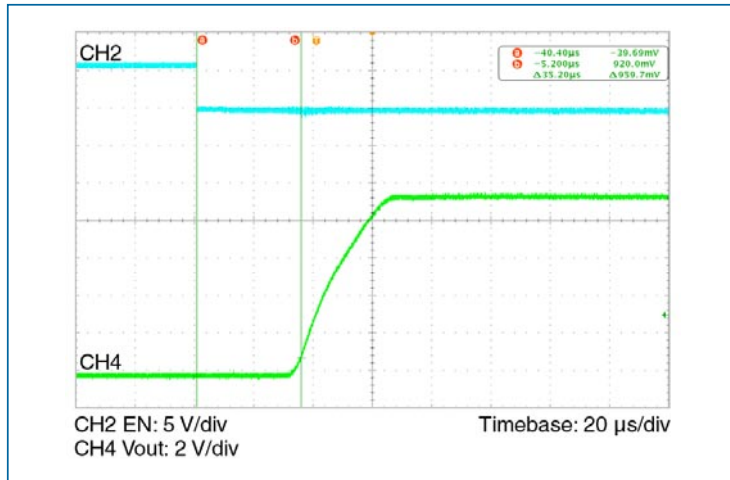

Figure 7 — Turn on delay time; Enable turn on delay at nominal line, 15% load, 0 load capacitance

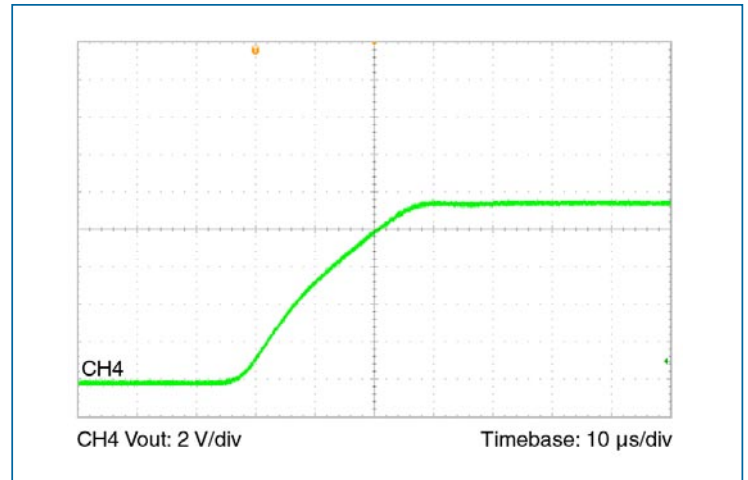

Figure 8 — Output voltage rise time at nominal line, 10% load 0 load capacitance

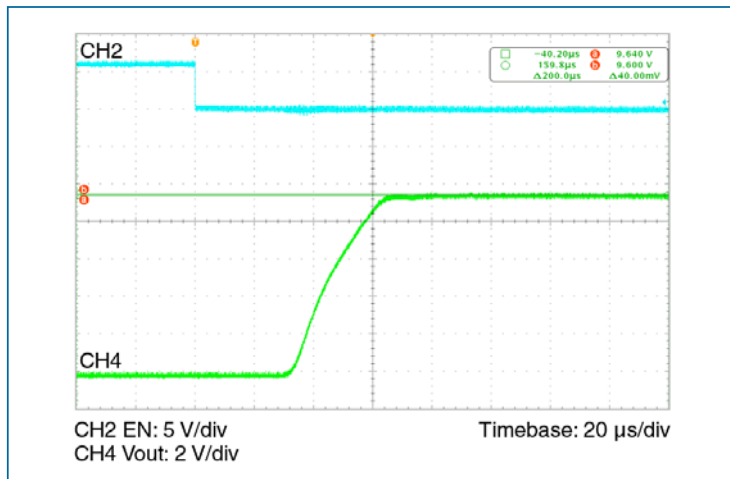

Figure 9 — Overshoot at turn on at nominal line, 15% load 0 load capacitance

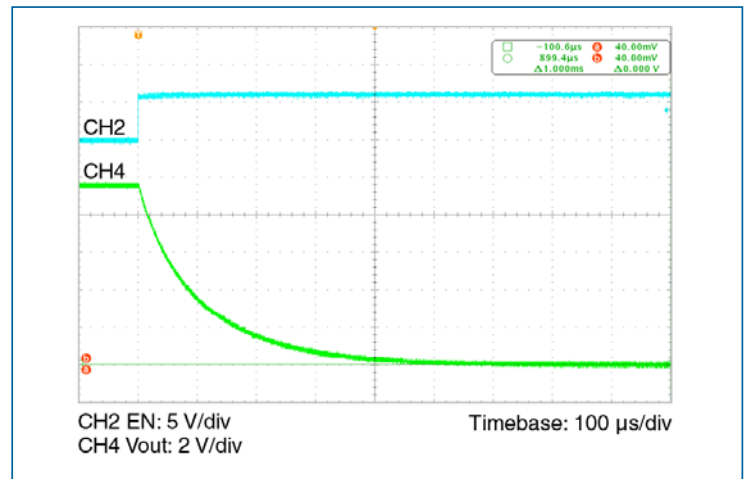

Figure 10 — Undershoot at turn off at nominal line, 15% load 0 load capacitance

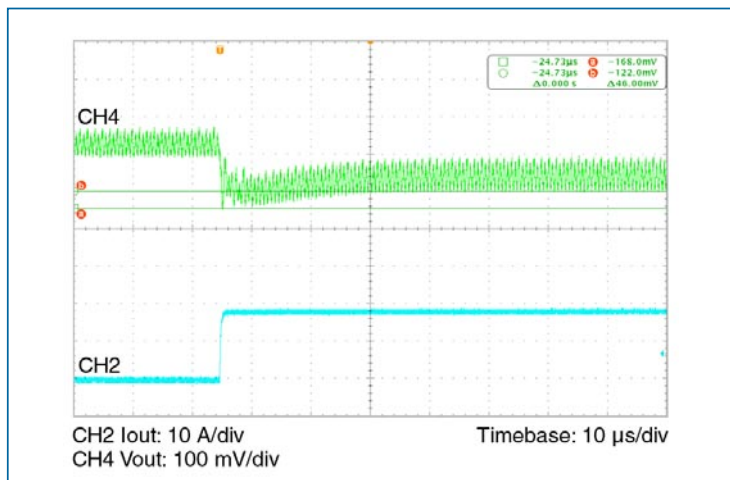

Figure 11 — Load transient response; nominal line Load step 75–100%

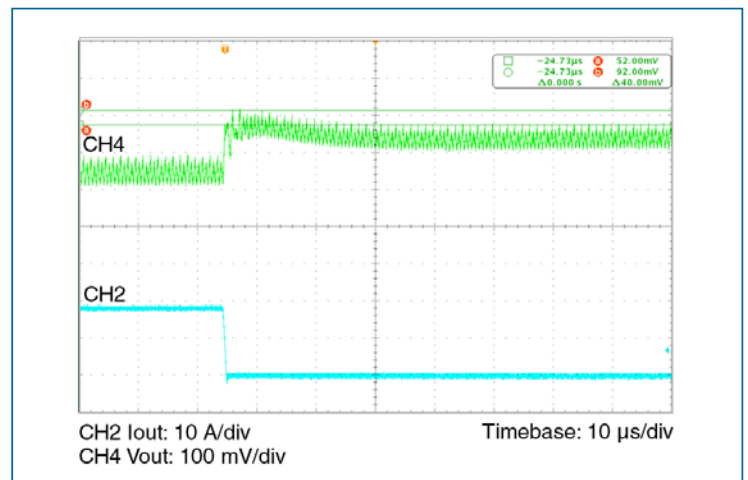

Figure 12 — Load transient response; Full load to 75%; nominal line

SPECIFICATIONS (CONT.)

WAVEFORMS (CONT.)

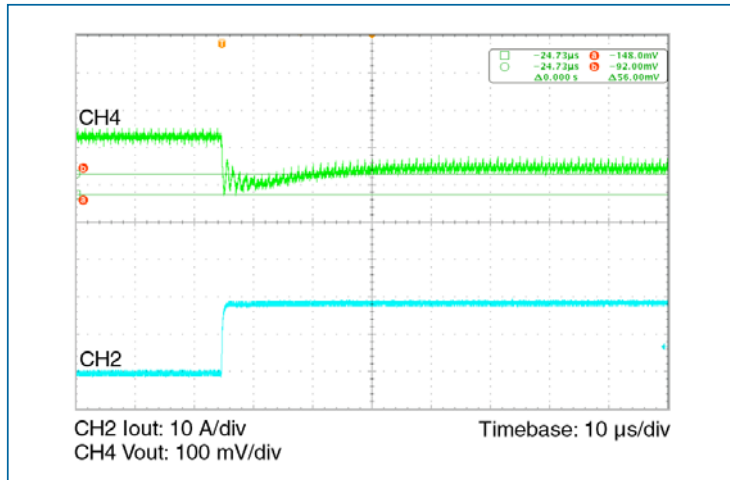

Figure 13 — Load transient response; nominal line
Load step 0–25%; 10 A/div

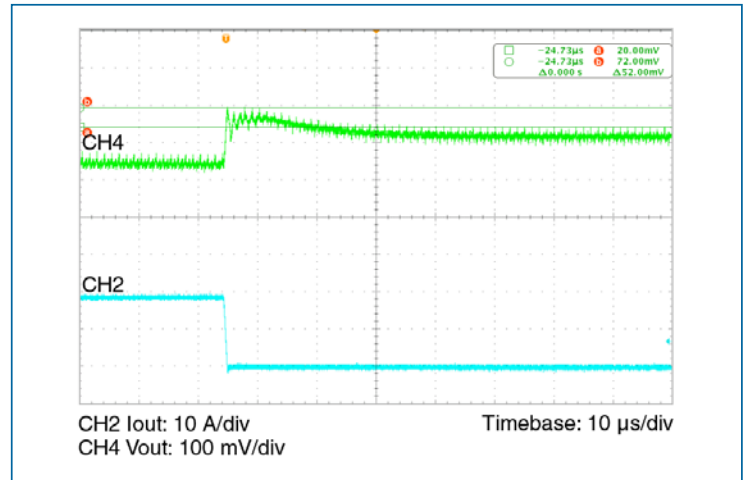

Figure 14 — Load transient response; 25–0%; nominal line

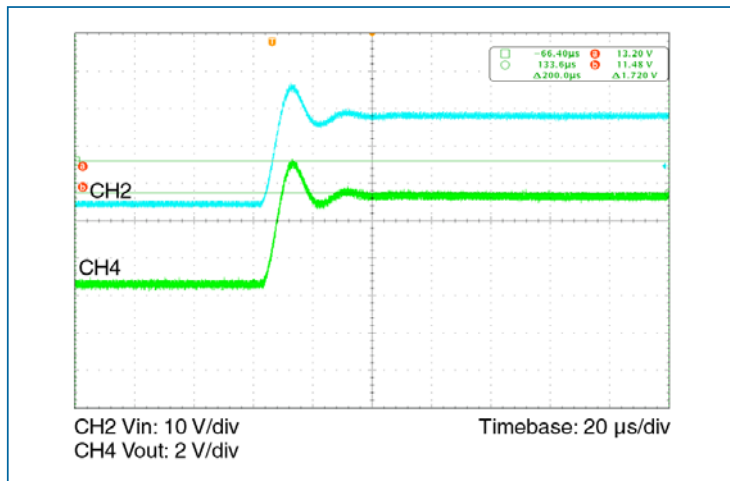

Figure 15 — Input transient response;
Vin step low line to high line at full load

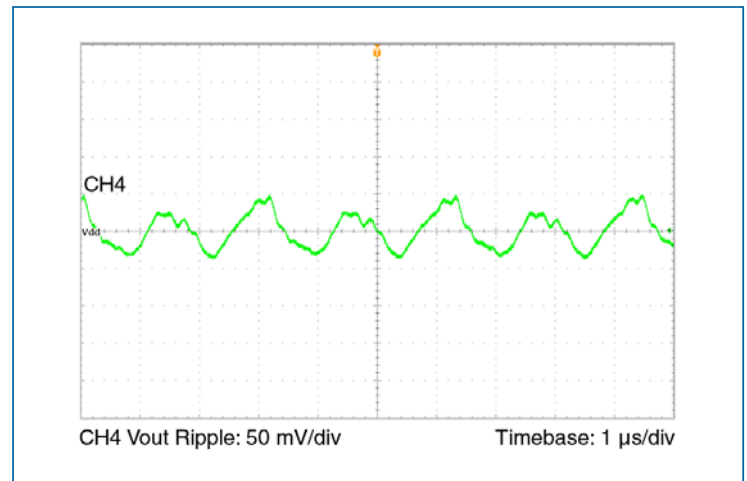

Figure 16 — Output ripple; Nominal line, full load

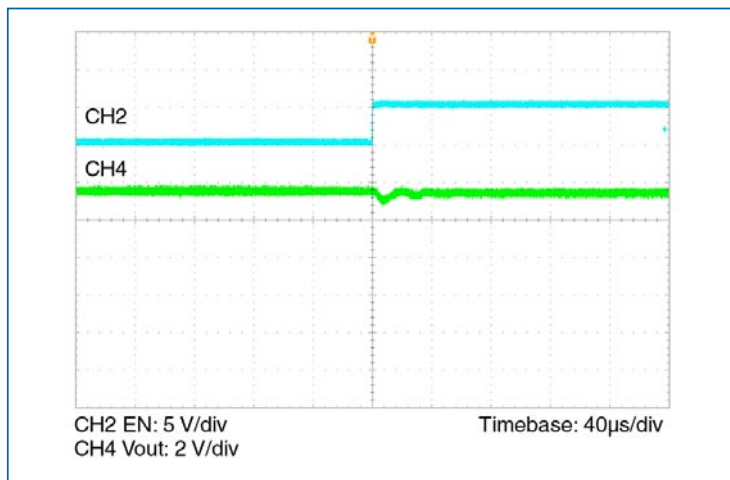

Figure 17 — Three module parallel array test. Vout change when one module is disabled. Nominal Vin, Iout = 160 A

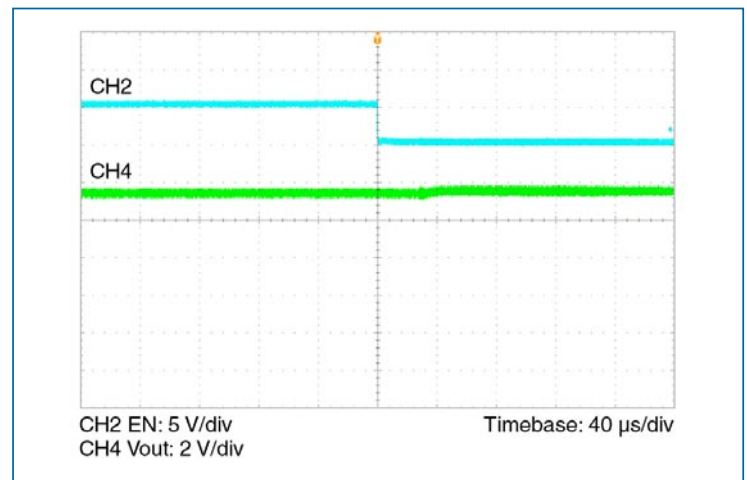

Figure 18 — Three module parallel array test. Vout change with two modules operating and a third module enabled. Nominal Vin, Iout = 160 A

SPECIFICATIONS (CONT.)

WAVEFORMS (CONT.)

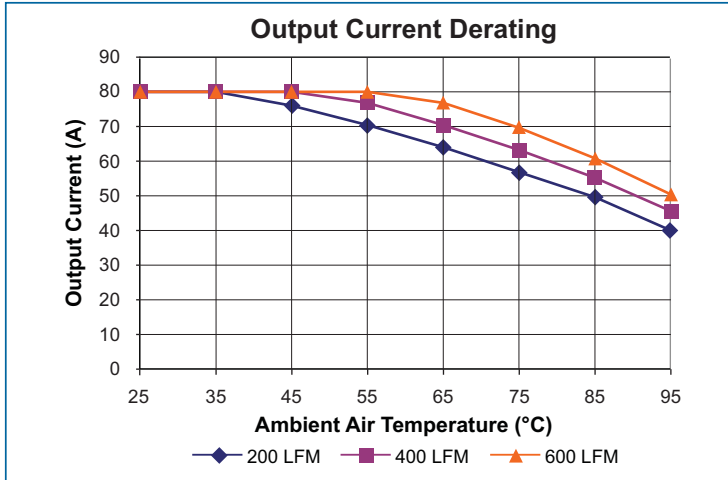

Figure 19 — Maximum output power derating vs ambient air temperature. Transverse airflow, Board and junction temperatures <125° C. Tested with IBC evaluation board IB050Q096T80N1-CB

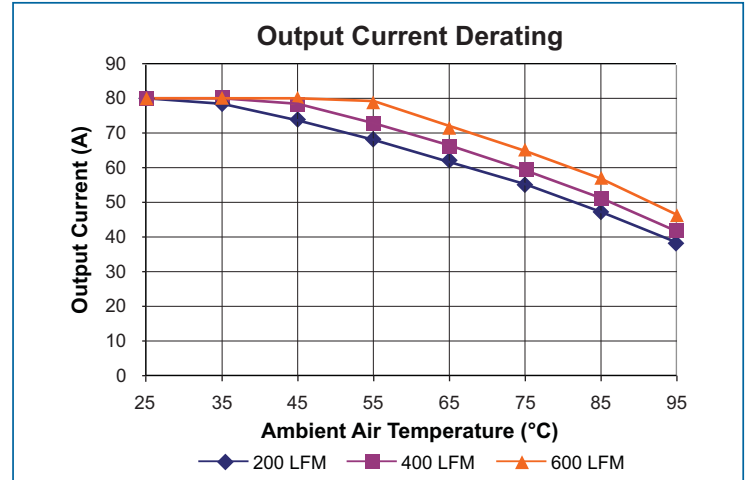

Figure 20 — Maximum output power derating vs ambient air temperature. Longitudinal airflow, Board and junction temperatures <125° C. Tested with IBC evaluation board IB050Q096T80N1-CB

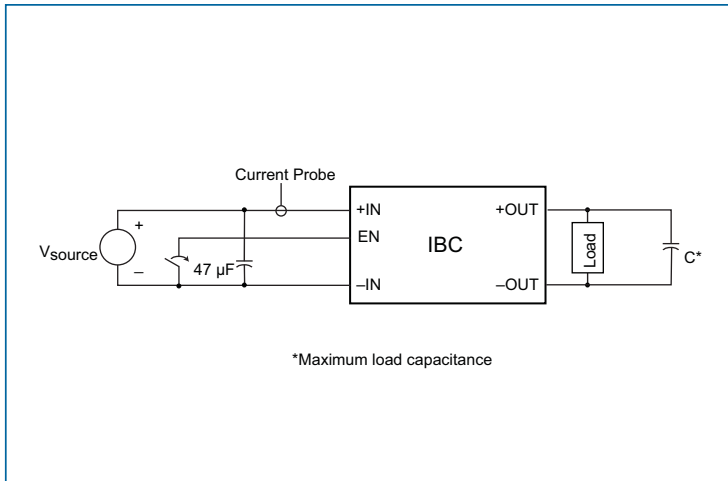

Figure 21 — Test circuit; inrush current overshoot

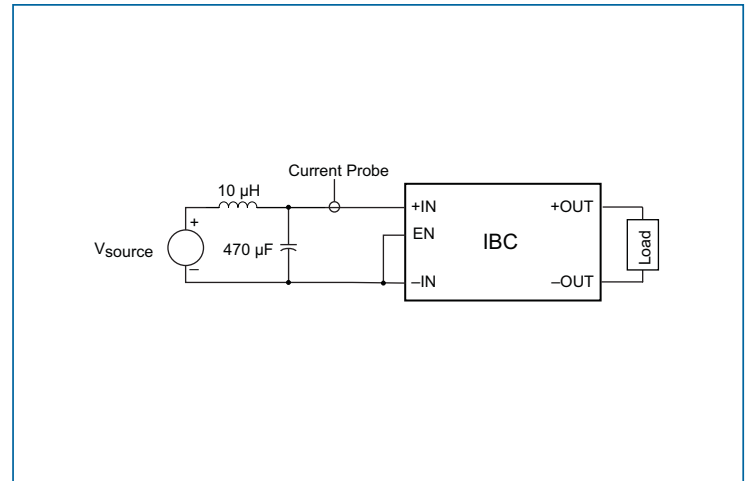

Figure 22 — Test circuit; input reflected ripple current

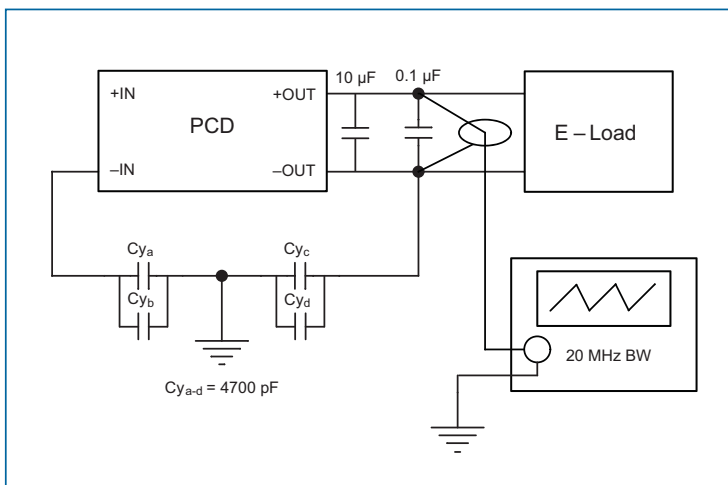

Figure 23 — Test circuit; output voltage ripple

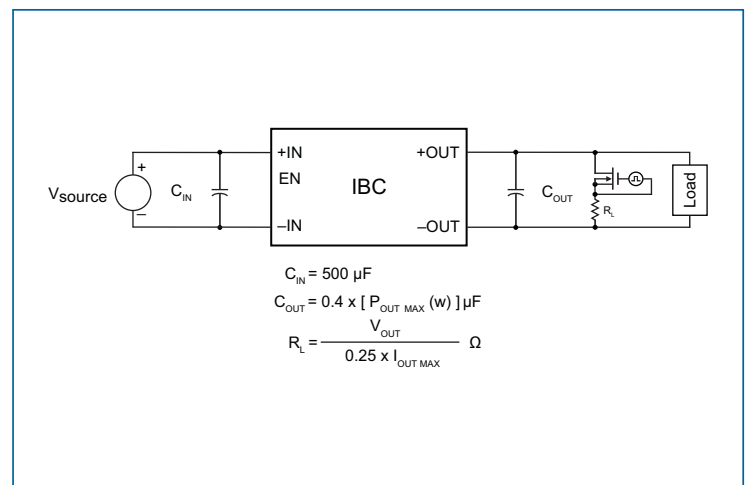

Figure 24 — Test circuit, load transient

SPECIFICATIONS (CONT.)

THERMAL DATA

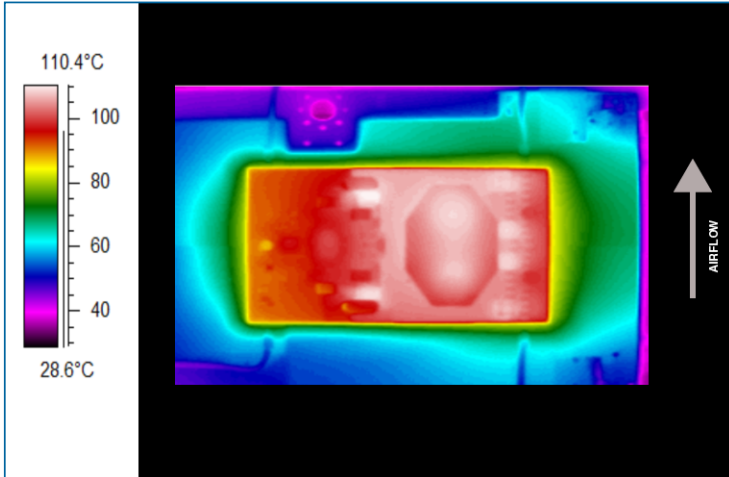

Figure 25 — Thermal plot, 200 LFM, 25°C, 48 Vin, 670 W output power

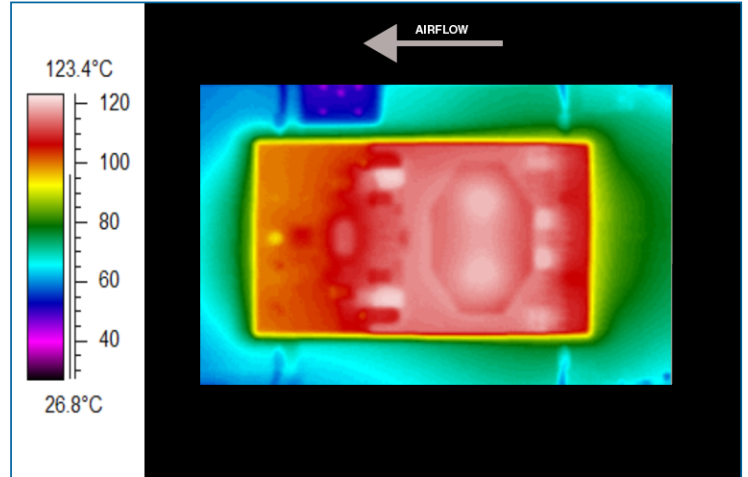

Figure 26 — Thermal plot, 200 LFM, 25°C, 48 Vin, 670 W output power

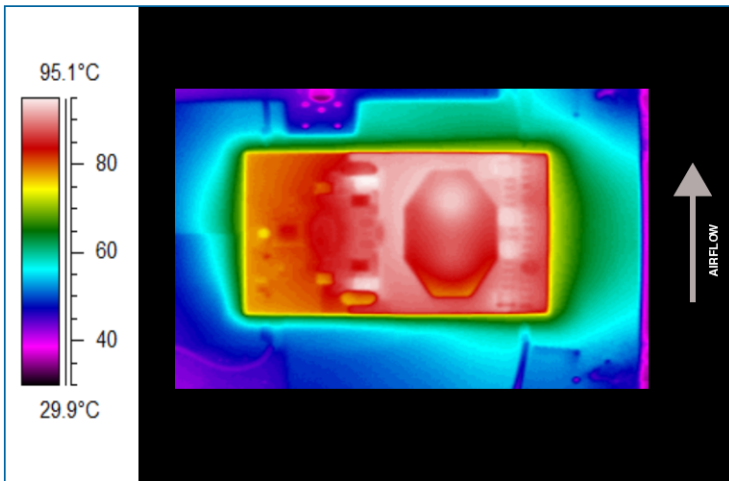

Figure 27 — Thermal plot, 400 LFM, 25°C, 48 Vin, 670 W output power

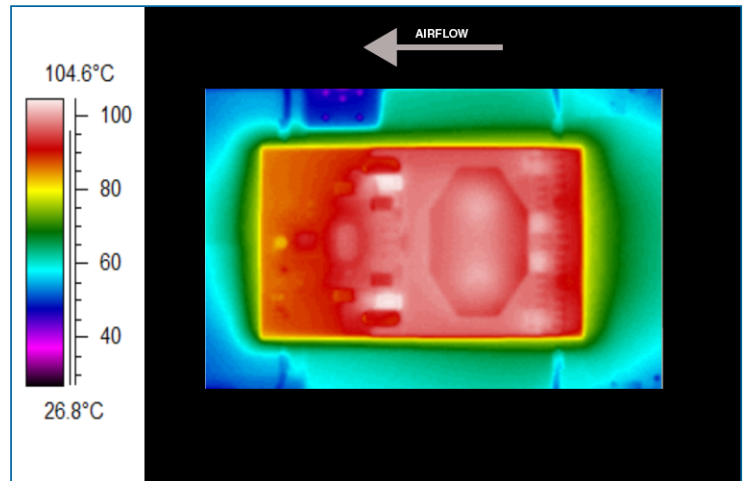

Figure 28 — Thermal plot, 400 LFM, 25°C, 48 Vin, 670 W output power

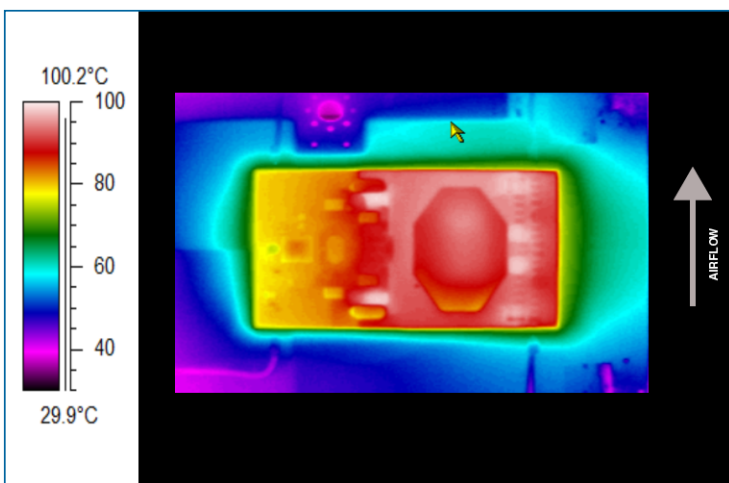

Figure 29 — Thermal plot, 600 LFM, 25°C, 48 Vin, 760 W output power

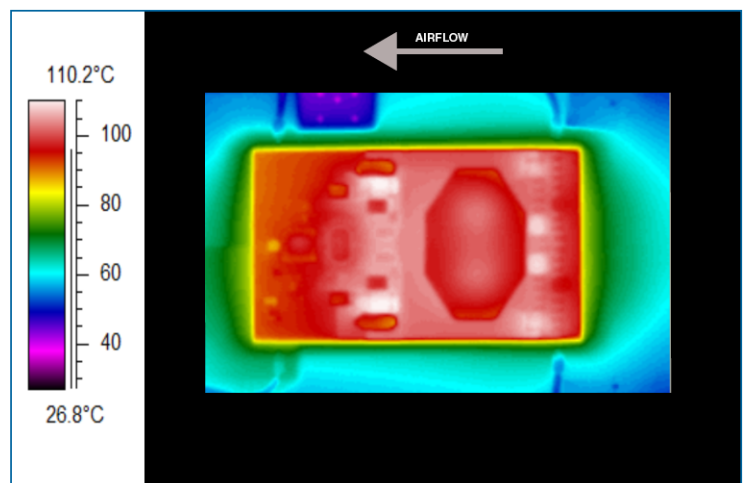

Figure 30 — Thermal plot, 600 LFM, 25°C, 48 Vin, 760 W output power

+In / -In – DC Voltage Input Pins

The IBC input voltage range should not be exceeded. An internal undervoltage/overvoltage lockout function prevents operation outside of the normal operating input range. The IBC turns on within an input voltage window bounded by the “Input under-voltage turn-on” and “Input over-voltage turn-off” levels, as specified. The IBC may be protected against accidental application of a reverse input voltage by the addition of a rectifier in series with the positive input, or a reverse rectifier in shunt with the positive input located on the load side of the input fuse.

The connection of the IBC to its power source should be implemented with minimal distribution inductance. If the interconnect inductance exceeds 100 nH, the input should be bypassed with a RC damper to retain low source impedance and stable operation. With an interconnect inductance of 200 nH, the RC damper may be 47 μ F in series with 0.3 Ω . A single electrolytic or equivalent low-Q capacitor may be used in place of the series RC bypass.

EN - Enable/Disable

Negative Logic Option

If the EN port is left floating, the IBC output is disabled. Once this port is pulled lower than 0.8 Vdc with respect to –In, the output is enabled. The EN port can be driven by a relay, opto-coupler, or open collector transistor. Refer to Figures 6 and 7 for the typical enable / disable characteristics. This port should not be toggled at a rate higher than 1 Hz. The EN port should also not be driven by or pulled up to an external voltage source.

Positive Logic Option

If the EN port is left floating, the IBC output is enabled. Once this port is pulled lower than 1.4 Vdc with respect to –In, the output is disabled. This action can be realized by employing a relay, opto-coupler, or open collector transistor. This port should not be toggled at a rate higher than 1 Hz.

The EN port should also not be driven by or pulled up to an external voltage source. The EN port can source up to 2 mA at 5 Vdc. The EN port should never be used to sink current.

If the IBC is disabled using the EN pin, the module will attempt to restart approximately every 250ms. Once the module has been disabled for at least 250ms, the turn on delay after the EN pin is enabled will be as shown in Figure 7.

+Out / -Out – DC Voltage Output Pins

Total load capacitance at the output of the IBC should not exceed the specified maximum. Owing to the wide bandwidth and low output impedance of the IBC, low frequency bypass capacitance and significant energy storage may be more densely and efficiently provided by adding capacitance at the input of the IBC.

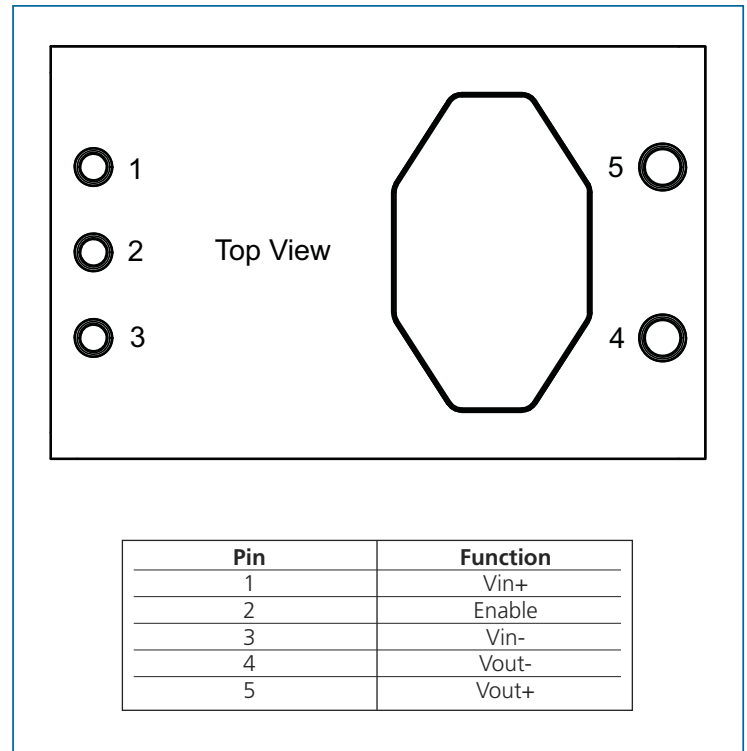

Figure 31 — IBC Pin Designations

APPLICATIONS NOTE

Parallel Operation

The IBC will inherently current share when operated in an array. Arrays may be used for higher power or redundancy in an application. Current sharing accuracy is maximized when the source and load impedance presented to each IBC within an array are equal. The recommended method to achieve matched impedances is to dedicate common copper planes within the PCB to deliver and return the current to the array, rather than rely upon traces of varying lengths. In typical applications the current being delivered to the load is larger than that sourced from the input, allowing narrower traces to be utilized on the input side if necessary. The use of dedicated power planes is, however, preferable.

One or more IBCs in an array may be disabled without adversely affecting operation or reliability as long as the load does not exceed the rated power of the enabled IBCs.

The IBC power train and control architecture allow bi-directional power transfer, including reverse power processing from the IBC output to its input. The IBC's ability to process power in reverse improves the IBC transient response to an output load dump.

Thermal Considerations

The temperature distribution of the VI Brick can vary significantly with its input/output operating conditions, thermal management and environmental conditions. Although the PCB is UL rated to 130°C, it is recommended that PCB temperatures be maintained at or below 125°C. For maximum long term reliability, lower PCB temperatures are recommended for continuous operation, however, short periods of operation at 125°C will not negatively impact performance or reliability.

WARNING: Thermal and voltage hazards. The IBC can operate with surface temperatures and operating voltages that may be hazardous to personnel. Ensure that adequate protection is in place to avoid inadvertent contact.

Input Impedance Recommendations

To take full advantage of the IBC capabilities, the impedance presented to its input terminals must be low from DC to approximately 5 MHz. The source should exhibit low inductance and should have a critically damped response. If the interconnect inductance is excessive, the IBC input pins should be bypassed with an RC damper (e.g., 47 μ F in series with 0.3 Ω) to retain low source impedance and proper operation. Given the wide bandwidth of the IBC, the source response is generally the limiting factor in the overall system response.

Anomalies in the response of the source will appear at the output of the IBC multiplied by its K factor. The DC resistance of the source should be kept as low as possible to minimize voltage deviations. This is especially important if the IBC is operated near low or high line as the overvoltage/undervoltage detection circuitry could be activated.

Input Fuse Recommendations

The IBC is not internally fused in order to provide flexibility in configuring power systems. However, input line fusing of VI Bricks must always be incorporated within the power system. A fast acting fuse should be placed in series with the +In port. See safety agency approvals.

Application Notes

For IBC and VI Brick application notes on soldering, thermal management, board layout, and system design visit vicorpower.com.

PART NUMBERING

Product Family	Input Voltage	Package	Nominal Output Voltage	Temperature Grade	Output Current	Enable Logic	Pin Length	Options
IB	050	Q	096	T	80	N = Negative P = Positive	1 = 0.145 2 = 0.210 3 = 0.180	-00 = Open frame -BP = Baseplate*

*For baseplate option please contact the factory for availability.

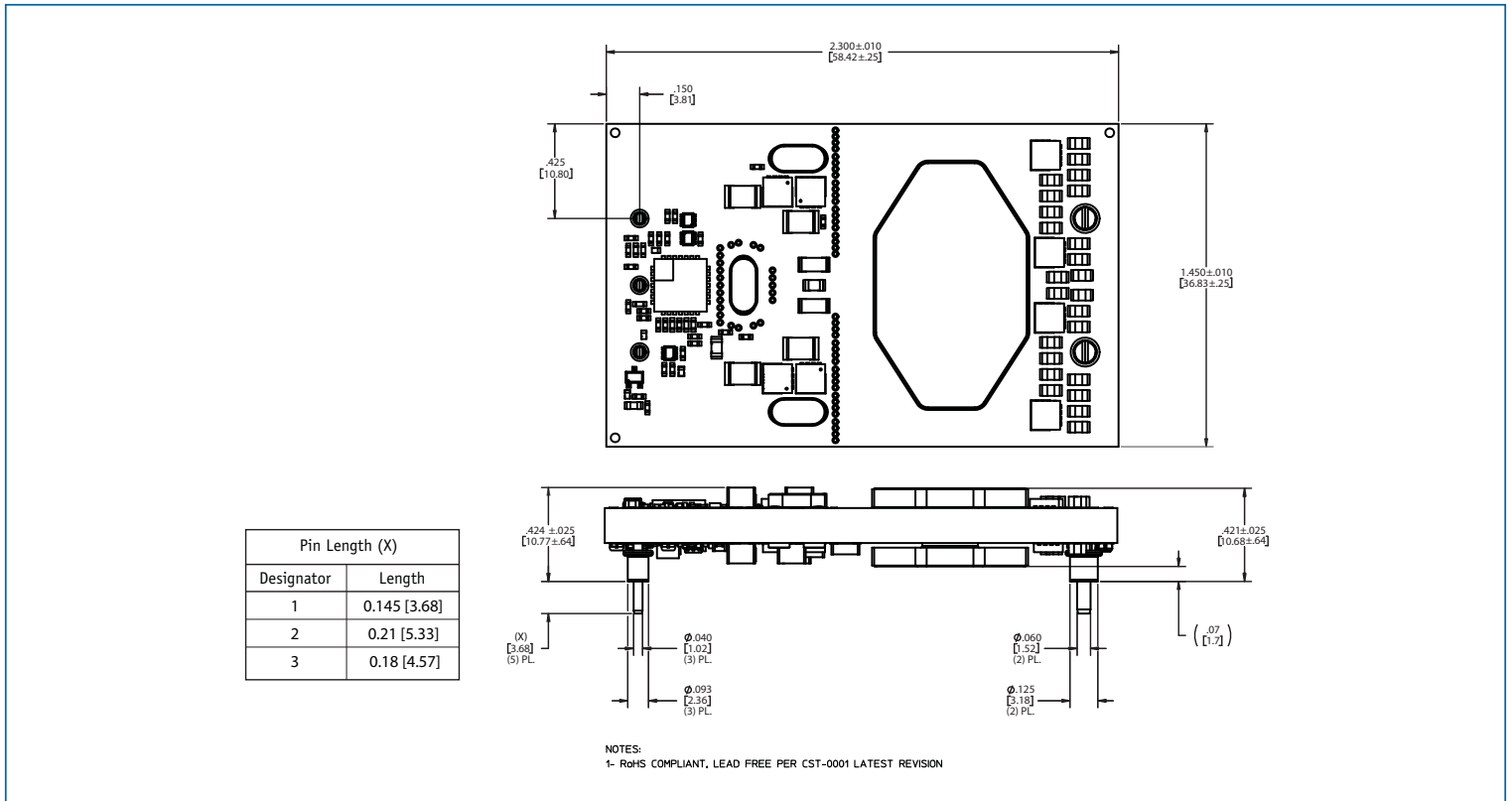

Figure 32 — IBC Outline drawing

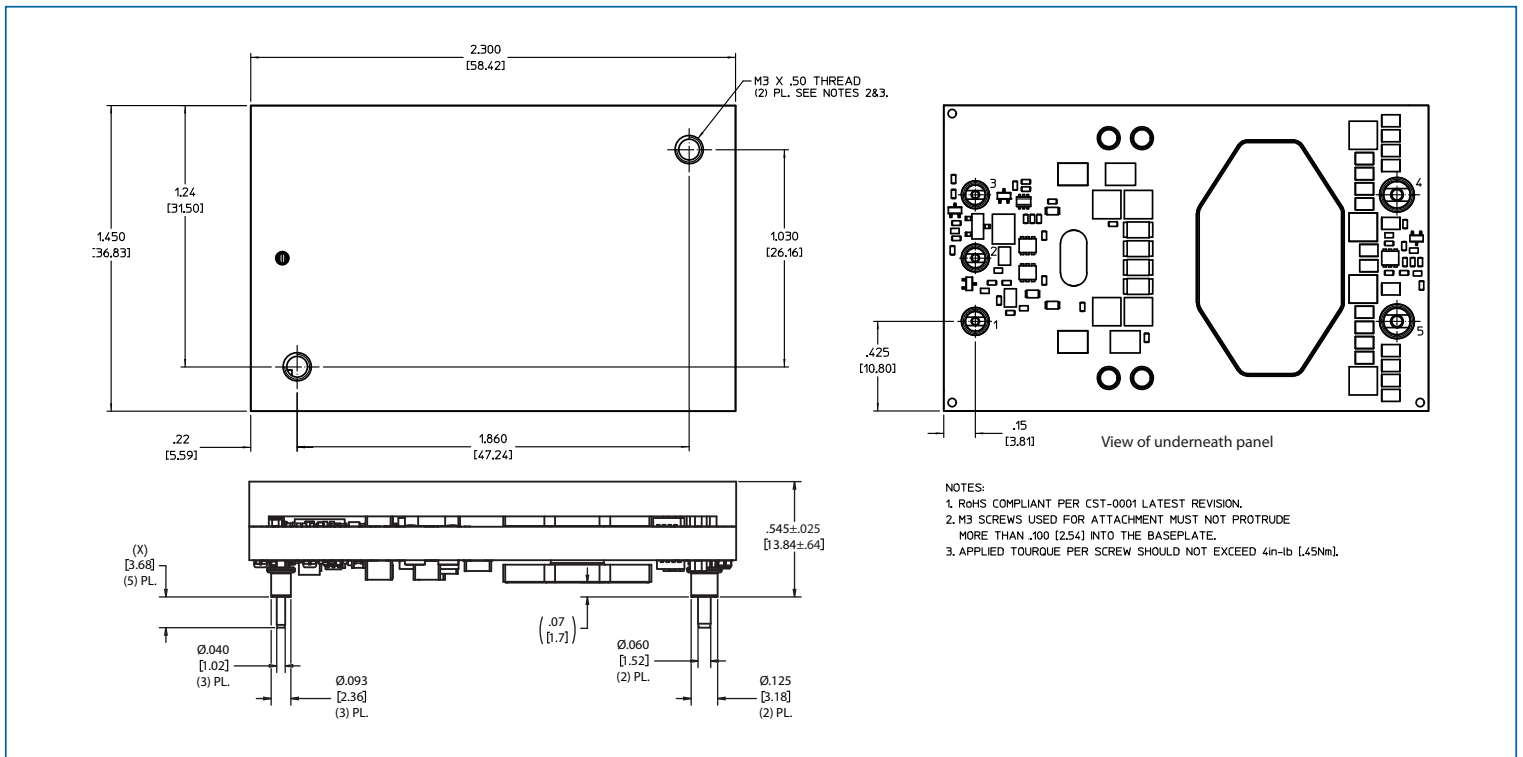
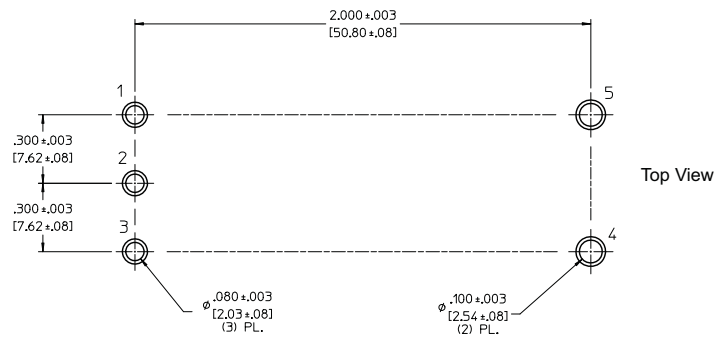

Figure 33 — IBC outline drawing - baseplate option

RECOMMENDED HOLE PATTERN



NOTES:
 1- RoHS COMPLIANT, LEAD FREE PER CST-0001 LATEST REVISION.

Figure 34 — IBC PCB recommended hole pattern

Vicor's comprehensive line of power solutions includes high density AC-DC and DC-DC modules and accessory components, fully configurable AC-DC and DC-DC power supplies, and complete custom power systems.

Information furnished by Vicor is believed to be accurate and reliable. However, no responsibility is assumed by Vicor for its use. Vicor makes no representations or warranties with respect to the accuracy or completeness of the contents of this publication. Vicor reserves the right to make changes to any products, specifications, and product descriptions at any time without notice. Information published by Vicor has been checked and is believed to be accurate at the time it was printed; however, Vicor assumes no responsibility for inaccuracies. Testing and other quality controls are used to the extent Vicor deems necessary to support Vicor's product warranty. Except where mandated by government requirements, testing of all parameters of each product is not necessarily performed.

Specifications are subject to change without notice.

Vicor's Standard Terms and Conditions

All sales are subject to Vicor's Standard Terms and Conditions of Sale, which are available on Vicor's webpage or upon request.

Product Warranty

In Vicor's standard terms and conditions of sale, Vicor warrants that its products are free from non-conformity to its Standard Specifications (the "Express Limited Warranty"). This warranty is extended only to the original Buyer for the period expiring two (2) years after the date of shipment and is not transferable.

UNLESS OTHERWISE EXPRESSLY STATED IN A WRITTEN SALES AGREEMENT SIGNED BY A DULY AUTHORIZED VICOR SIGNATORY, VICOR DISCLAIMS ALL REPRESENTATIONS, LIABILITIES, AND WARRANTIES OF ANY KIND (WHETHER ARISING BY IMPLICATION OR BY OPERATION OF LAW) WITH RESPECT TO THE PRODUCTS, INCLUDING, WITHOUT LIMITATION, ANY WARRANTIES OR REPRESENTATIONS AS TO MERCHANTABILITY, FITNESS FOR PARTICULAR PURPOSE, INFRINGEMENT OF ANY PATENT, COPYRIGHT, OR OTHER INTELLECTUAL PROPERTY RIGHT, OR ANY OTHER MATTER.

This warranty does not extend to products subjected to misuse, accident, or improper application, maintenance, or storage. Vicor shall not be liable for collateral or consequential damage. Vicor disclaims any and all liability arising out of the application or use of any product or circuit and assumes no liability for applications assistance or buyer product design. Buyers are responsible for their products and applications using Vicor products and components. Prior to using or distributing any products that include Vicor components, buyers should provide adequate design, testing and operating safeguards.

Vicor will repair or replace defective products in accordance with its own best judgment. For service under this warranty, the buyer must contact Vicor to obtain a Return Material Authorization (RMA) number and shipping instructions. Products returned without prior authorization will be returned to the buyer. The buyer will pay all charges incurred in returning the product to the factory. Vicor will pay all reshipment charges if the product was defective within the terms of this warranty.

Life Support Policy

VICOR'S PRODUCTS ARE NOT AUTHORIZED FOR USE AS CRITICAL COMPONENTS IN LIFE SUPPORT DEVICES OR SYSTEMS WITHOUT THE EXPRESS PRIOR WRITTEN APPROVAL OF THE CHIEF EXECUTIVE OFFICER AND GENERAL COUNSEL OF VICOR CORPORATION. As used herein, life support devices or systems are devices which (a) are intended for surgical implant into the body, or (b) support or sustain life and whose failure to perform when properly used in accordance with instructions for use provided in the labeling can be reasonably expected to result in a significant injury to the user. A critical component is any component in a life support device or system whose failure to perform can be reasonably expected to cause the failure of the life support device or system or to affect its safety or effectiveness. Per Vicor Terms and Conditions of Sale, the user of Vicor products and components in life support applications assumes all risks of such use and indemnifies Vicor against all liability and damages.

Intellectual Property Notice

Vicor and its subsidiaries own Intellectual Property (including issued U.S. and Foreign Patents and pending patent applications) relating to the products described in this data sheet. No license, whether express, implied, or arising by estoppel or otherwise, to any intellectual property rights is granted by this document. Interested parties should contact Vicor's Intellectual Property Department.

The products described on this data sheet are protected by the following U.S. Patents Numbers:
5,945,130; 6,403,009; 6,710,257; 6,911,848; 6,930,893; 6,934,166; 6,940,013; 6,969,909; 7,038,917;
7,166,898; 7,187,263; 7,361,844; D496,906; D505,114; D506,438; D509,472; and for use under 6,975,098 and 6,984,965.

Vicor Corporation

25 Frontage Road
Andover, MA, USA 01810
Tel: 800-735-6200
Fax: 978-475-6715

email

Customer Service: custserv@vicorpower.com
Technical Support: apps@vicorpower.com