



工程样品测试报告 (Engineering Test Report)

使用LNK406 (LNK-PH) 芯片设计的
40V@350mA, T8 LED电源

2011年07月11日, REV-E
ZY Gao

1. 主要功能及特点

工程报告 (使用LNK406EG芯片设计的 40V 350mA T8 LED电源) Page 2

- 1) 应用在T8型号的LED灯管, 40V@350mA
- 2) 宽电压范围输入 (90-305Vac)
- 3) 精准的恒流控制, 误差小于 $\pm 5\%$
- 4) 90-305Vac输入时效率大于85%
- 5) 单级反激功率因数校正, 90-305Vac输入时功率因数大于 0.95
- 6) 集成MOS管, 外围零件数目少

2. 电源产品规格

工程报告 (使用LNK406EG芯片设计的 40V 350mA T8 LED电源) Page 3

描述	符号	最小值	典型值	最大值	单位	附加信息/测试条件
输入						
电压	V_{IN}	90		305	Vac	零/火线, 无中线
功率因数	PF	0.95				
输出						
输出电压	V_{out}		40.0		V	14颗LED串联
输出电流	I_{out}		0.35		A	
效率	η	85%				115V或230V输入
总输出功率						
持续输出功率	P_{out}		14		W	总功率
峰值输出功率					W	
传导电磁干扰		6			dB	
环境温度	T_{amb}	0		40	C	空气自然对流

3. 线路图

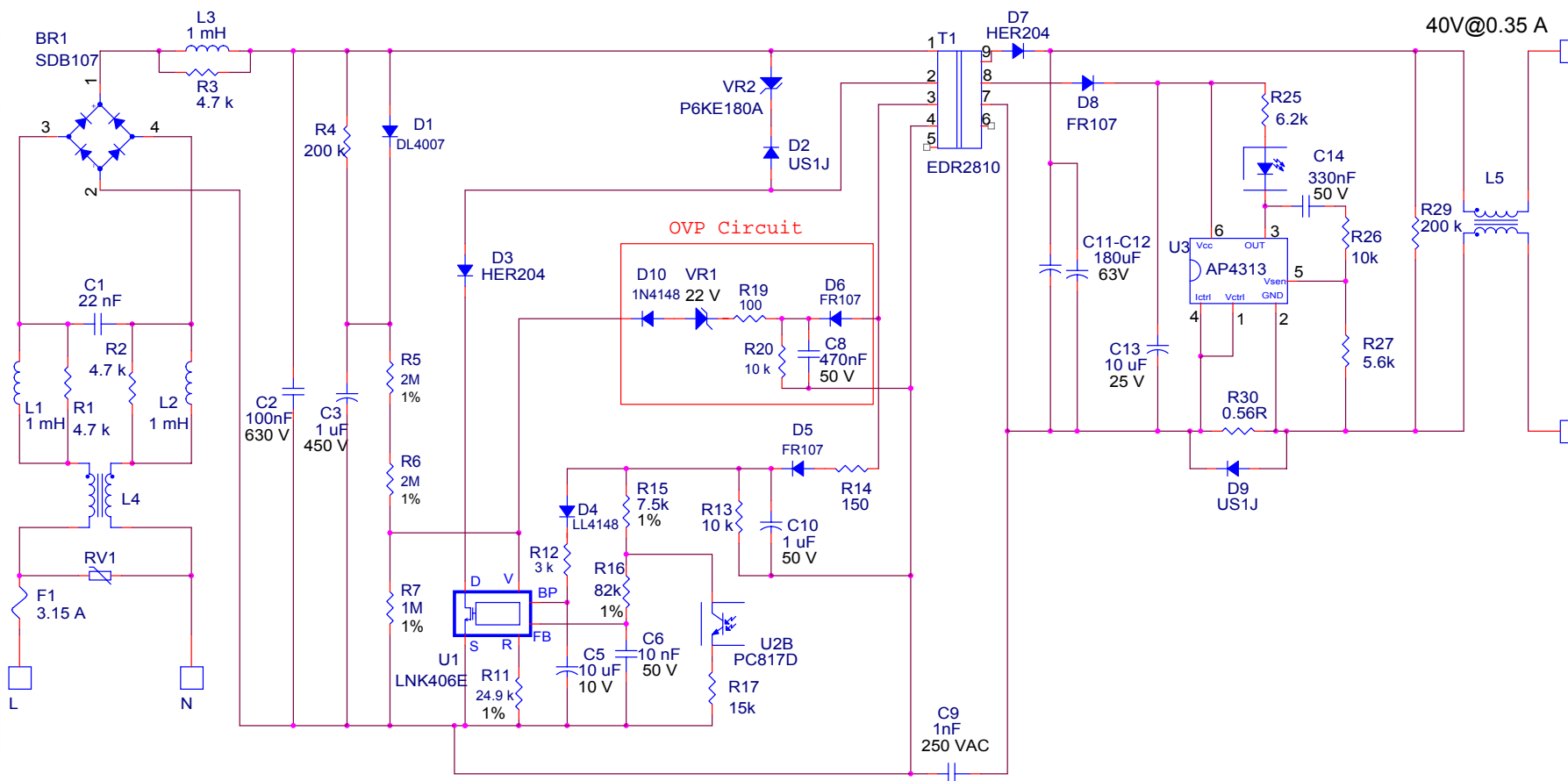

4. 工程样品外观图

工程报告 (使用LNK406EG芯片设计的 40V 350mA T8 LED电源) Page 5

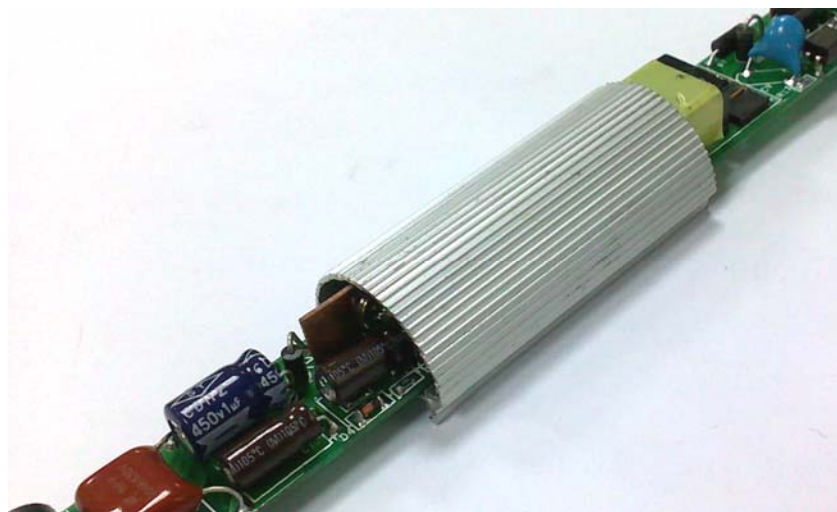

AC交流输入

LNK406EG

DC直流输出



5. 零件清单

工程报告 (使用LNK406EG芯片设计的 40V 350mA T8 LED电源) Page 6

编码	数量	零件位置	具体描述
1	1	BR1	SDB107
2	1	C1	22 nF, >305 VAC, X-CAP
3	1	C2	100 nF, 630 V,MP-CAP
4	1	C3	1 uF, 450 V, Electrolytic, (6.3 x 11)
5	2	C5,C13	10 uF, 50 V, Electrolytic, Very Low ESR, (6.3 x 11)
6	1	C6	10 nF, 50 V, Ceramic, X7R, 0805
7	1	C14	100 nF, 50 V, Ceramic, X7R, 0805
8	1	C8	1 uF, 50 V, Electrolytic, (6.3 x 11)
9	1	C9	1nF, Y-CAP
10	1	C10	1 uF, 50 V, Electrolytic, Low ESR, (6.3 x 11)
11	2	C10, C11	180 uF, 63V, Electrolytic, Low ESR, 255 mOhm, (10 x 12.5)
12	1	D1	1000 V, 1 A, Rectifier, DO-41, 1N4007
13	2	D2, D9	US1J,SMD
14	3	D5,D6,D8	1000 V, 1 A, Fast Recovery Diode, DO-41, FR107
15	2	D3,D7	300 V, 2 A, Ultrafast Recovery, DO-41, HER204
16	2	D4 ,D10	75 V, 0.15 A, MELF, 1N4148
17	1	F1	3.15 A, 250V, Slow, TR5
18	3	L1,L2, L3,	1000 uH, 0.3 A, 8 x 10.5 mm
19	1	L4	4 mH, 0.7 A, Common Mode Choke, TOROID, 35TURNS
20	1	L5	300uH,Common Mode Choke, TOROID, 10TURNS
21	3	R1, R2, R3	4.7 k, 5%, 1/8 W, Carbon Film
22	1	R4	200 k, 5%, 1/4 W, Thick Film, 1206

编码	数量	零件位置	具体描述
23	2	R5,R6	2M, 1%, 1/4 W, Thick Film, 1206
24	1	R7	1 M, 1%, 1/8 W, Thick Film, 0805
25	1	R11	24.9 k, 1%, 1/8 W, 0805
26	1	R12	3 k, 5%, 1/8 W, Thick Film, 0805
27	3	R13,R15,R20	10 k, 5%, 1/8 W, Thick Film, 0805
28	1	R14	150 R, 5%, 1/8 W, 0805
29	1	R16	82 k, 1%, 1/8 W, Thick Film, 0805
30	1	R17	15 k, 5%, 1/8 W, Thick Film, 0805
31	1	R19	100 R, 5%, 1/4 W, Thick Film, 0805
32	1	R25	6.2 k, 5%, 1/8 W, Thick Film, 0805
33	1	R26	10k,5%, 1/8 W, Thick Film, 0805
34	1	R27	5.6k, 5%, 1/8 W, Thick Film, 0805
35	1	R29	200K, 5%, 1/4 W, Thick Film,1206
36	1	R30	0.93R, 1%, 1/2 W, MR
37	1	RV1	275 V, 23 J, 7 mm, RADIAL ,10D431 (Metal Oxide Varistor)
38	1	T1	Bobbin, EDR2810, Horizontal, 9 pins (5 +4)
39	1	U1	LinkSwitch, LNK406E, eSIP
40	1	U2	PC817D,DIP-4
41	1	U3	AP4313,SOT-23-6
42	1	VR1	22V.0.5W,Z-Diode
43	1	VR2	180V,TVS-Diode

6. 变压器规格

示意图

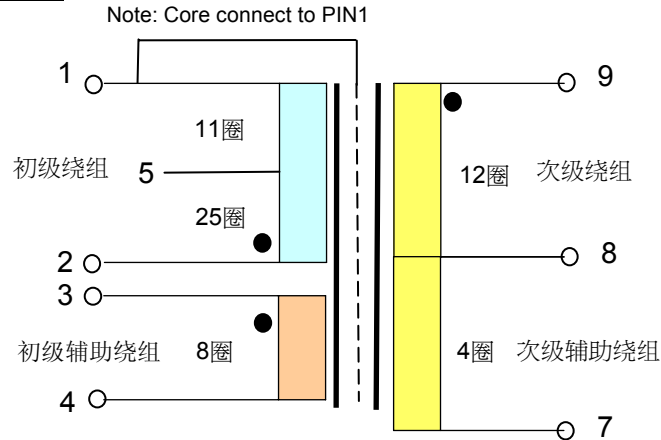

电气规格:

1. 初级感量 (Lp) = 850uH ± 7% @66KHz 0.4V
2. 初级漏感 < 50uH @66KHz 0.4V
3. 抗电强度 = 3KV, 50/60Hz, 1Min

材料:

1. 磁芯: 特殊EDR2810(铁氧体 TDK PC40 或其他等效)
2. 骨架: 卧式 (5+4 脚).
3. 绕线 (初级和辅助绕组): 类型 2-U EW
4. 绕线 (次级绕组): 三层绝缘线
5. 绕组间绝缘胶布 :3M1298 或其他等效

组装:

1. 组立后需要泡凡立水

绕组结构图...

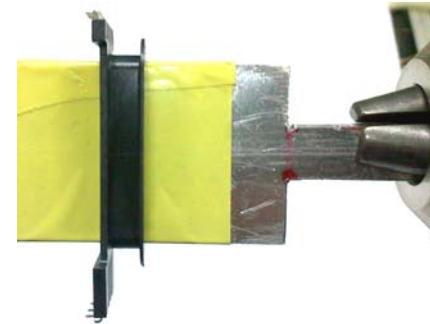

起始端为2脚 结束端为5脚, 从此箭头方向看过去定义为顺时针方向

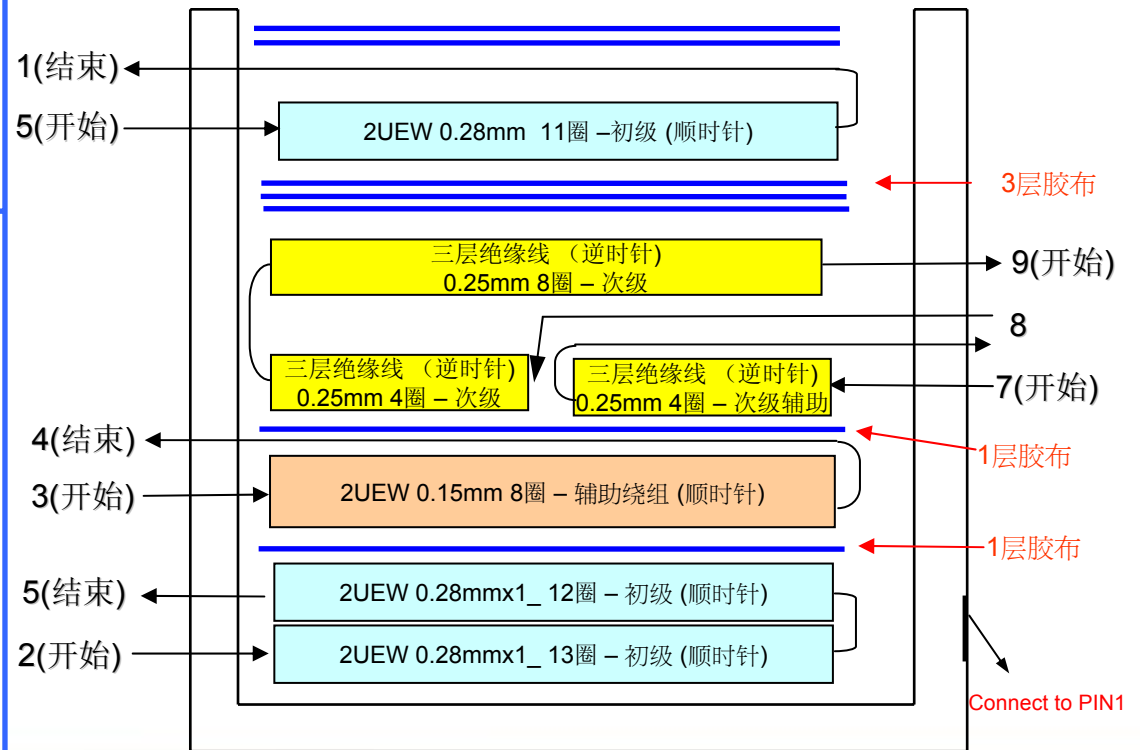

7. 测试效率

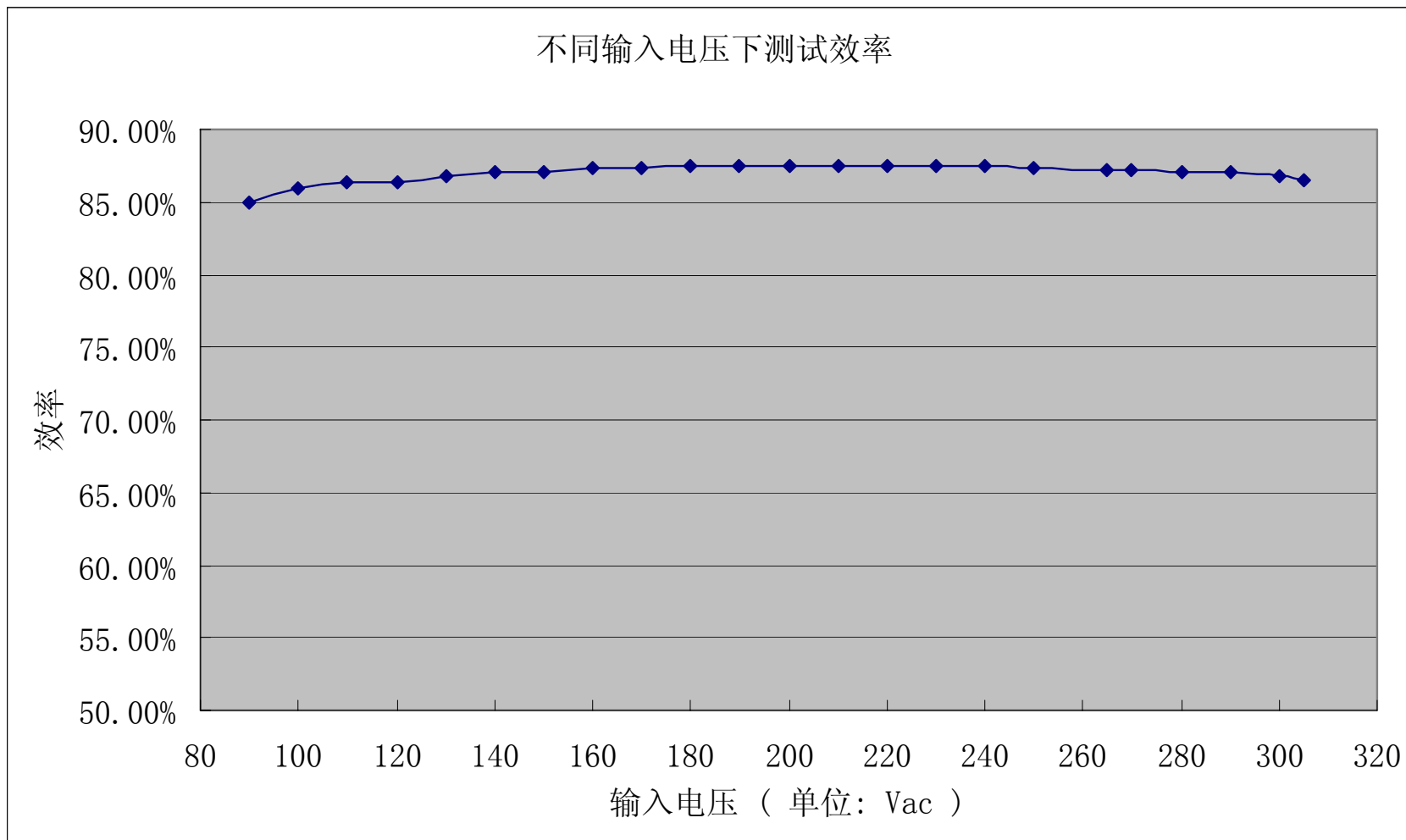

8. 谐波电流测量值和Class C限制值 (<25W)

工程报告 (使用LNK406EG芯片设计的 40V 350mA T8 LED电源) Page 9

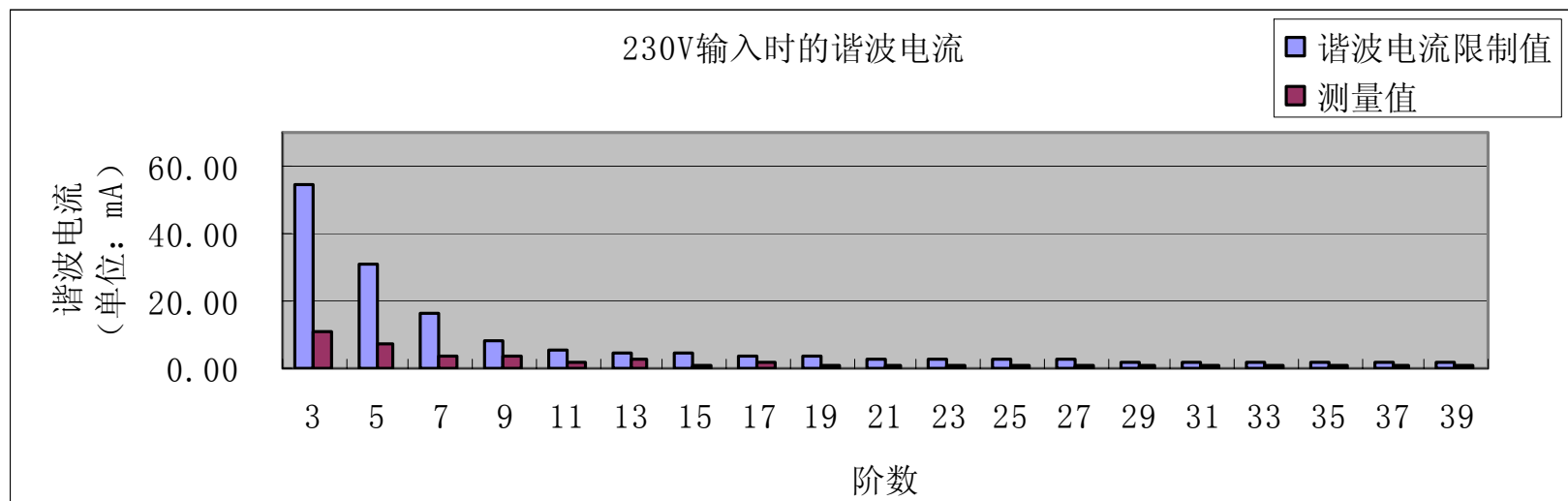
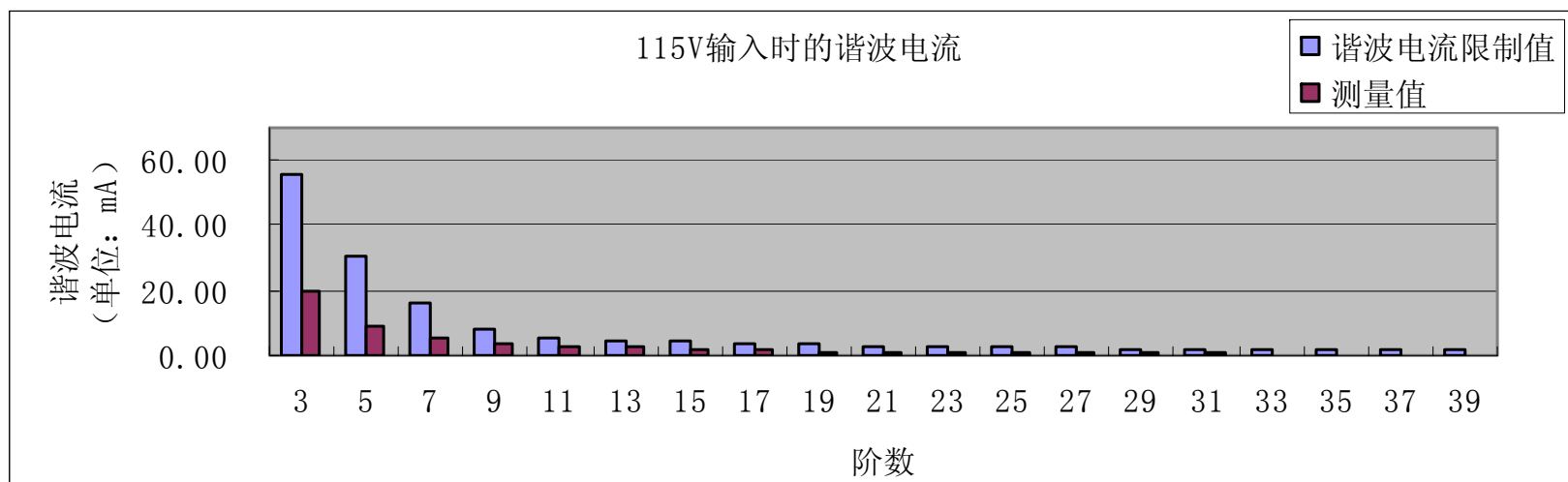

9. 功率因数

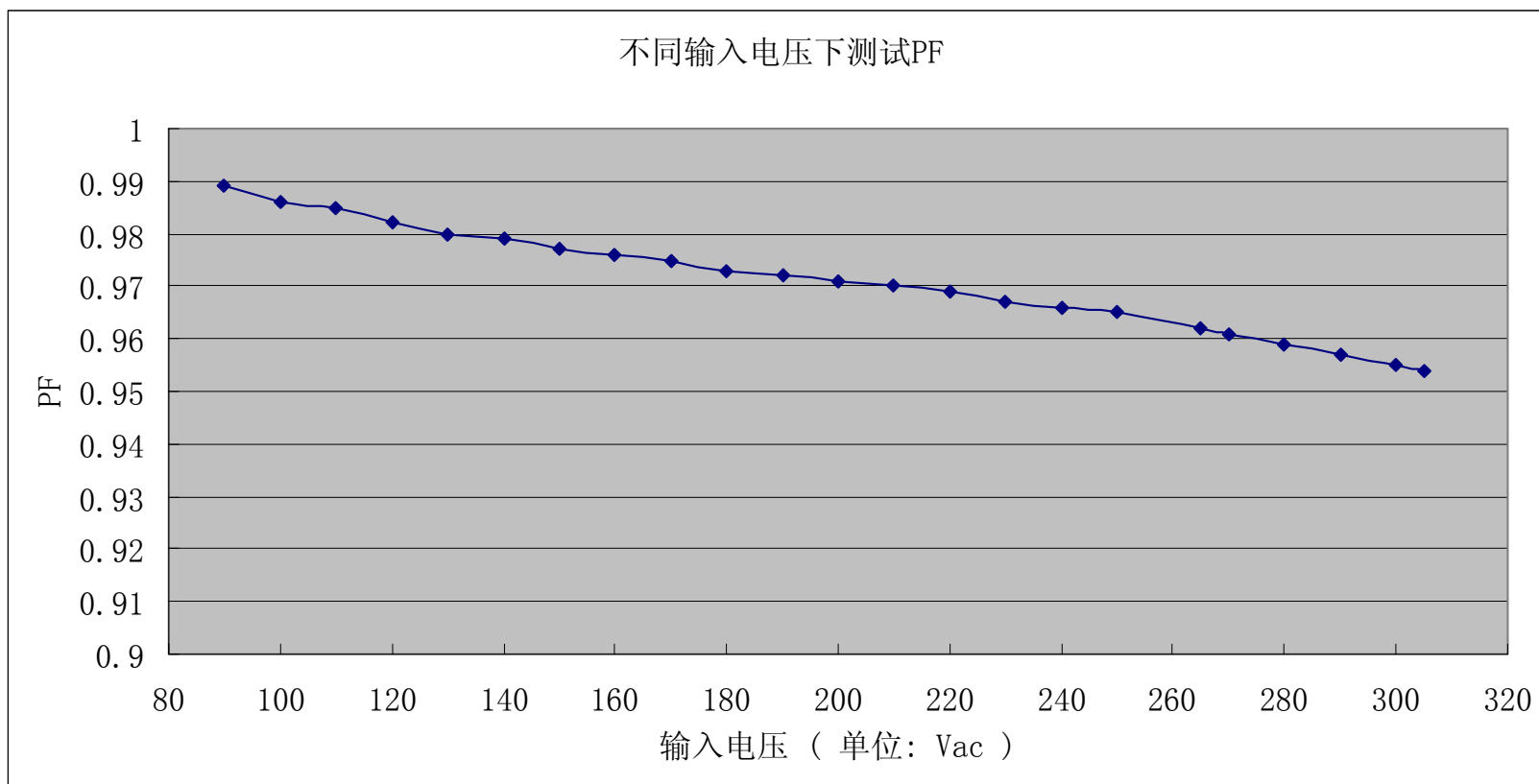

10. (1) 输出恒流特性(不同输入电压)

工程报告 (使用LNK406EG芯片设计的 40V 350mA T8 LED电源) Page 11

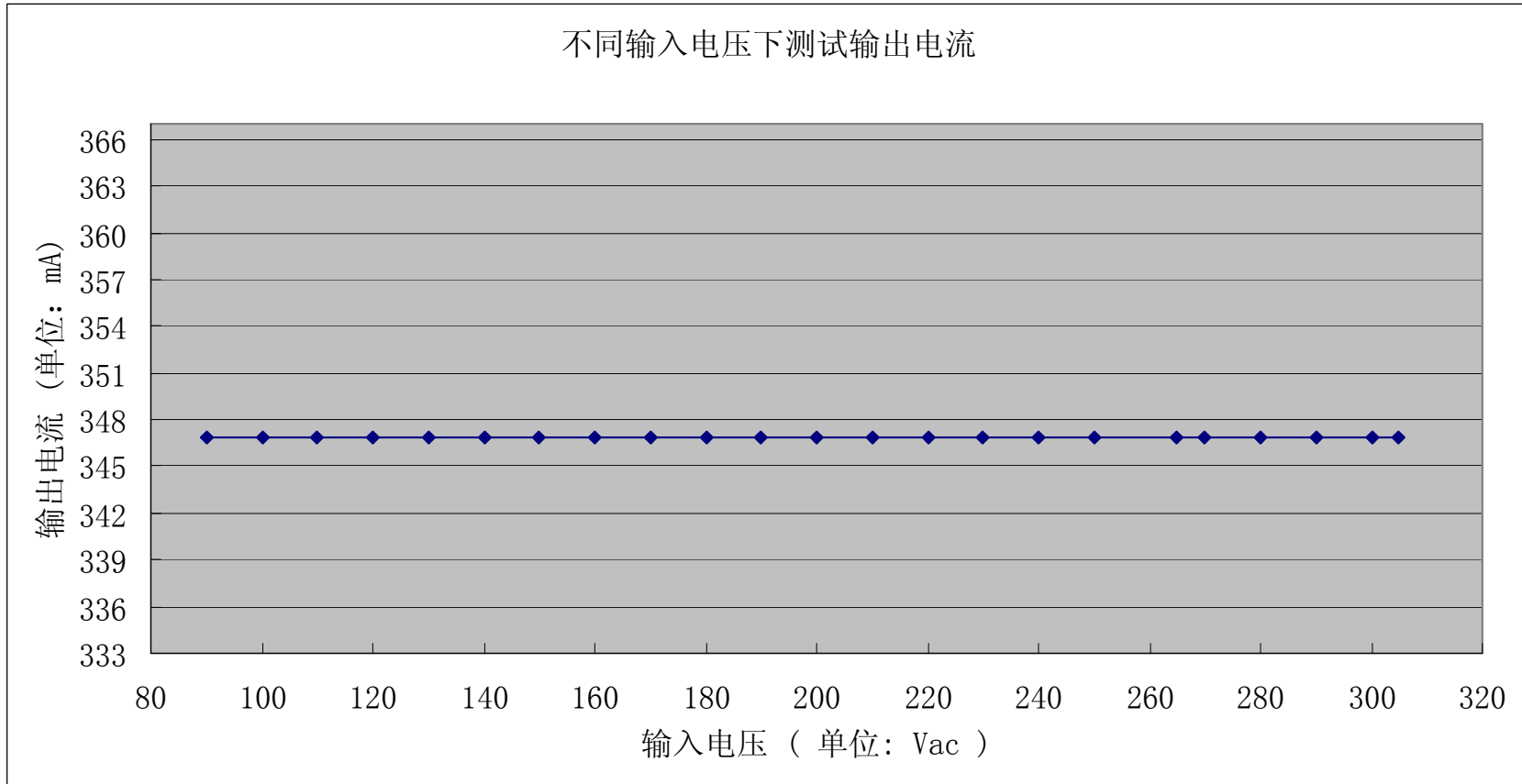

10. (2) 输出恒流特性 (不同输出电压)

工程报告 (使用LNK406EG芯片设计的 40V 350mA T8 LED电源) Page 12

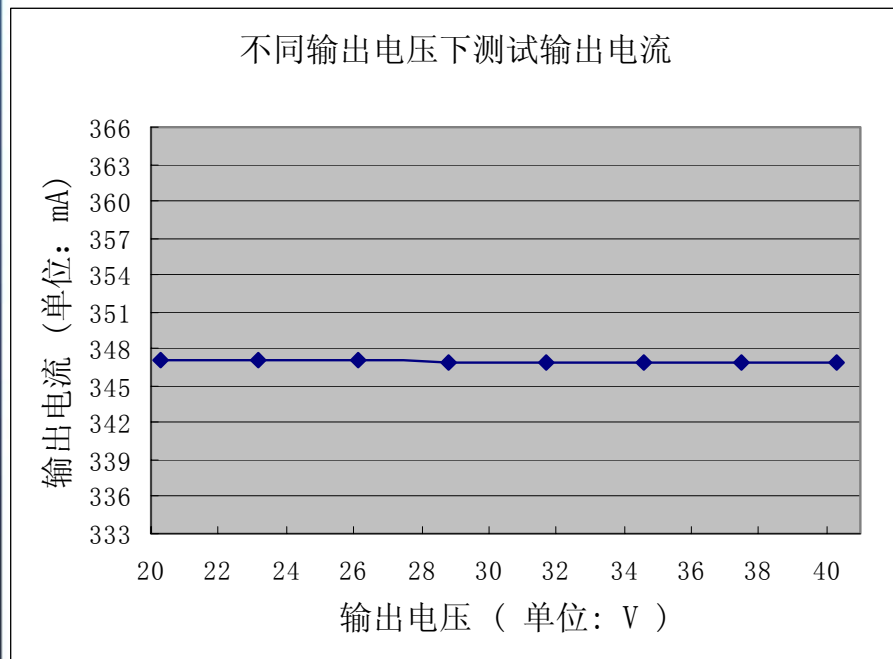

90Vac电压输入

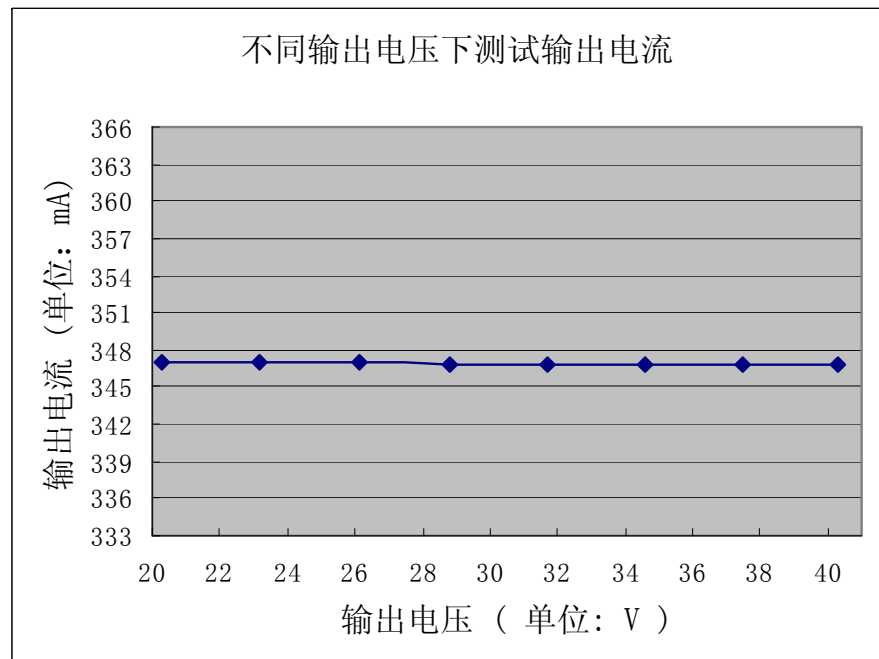

305Vac电压输入

11. 起机过程波形

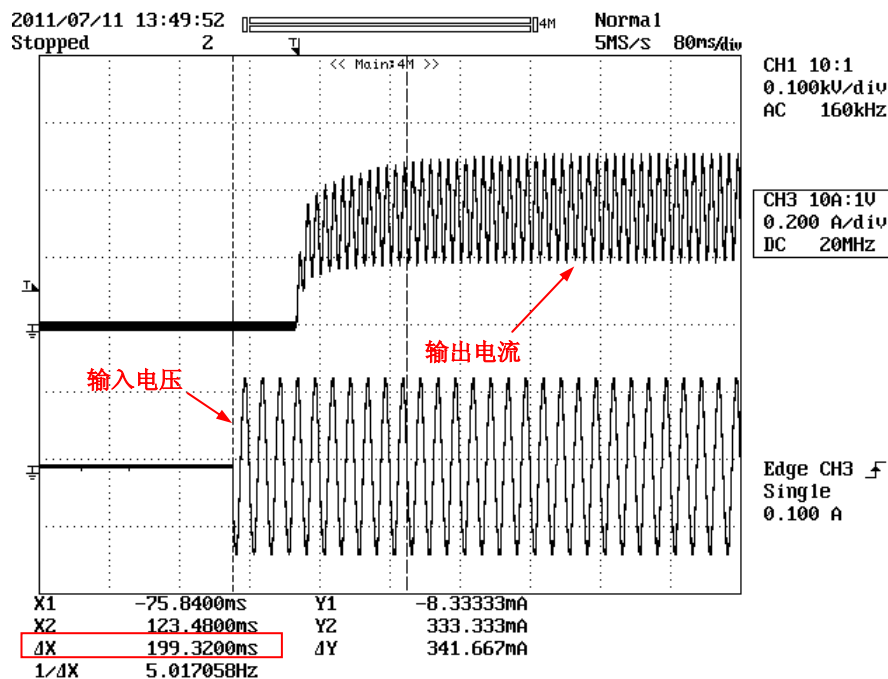

满载, 90Vac电压输入

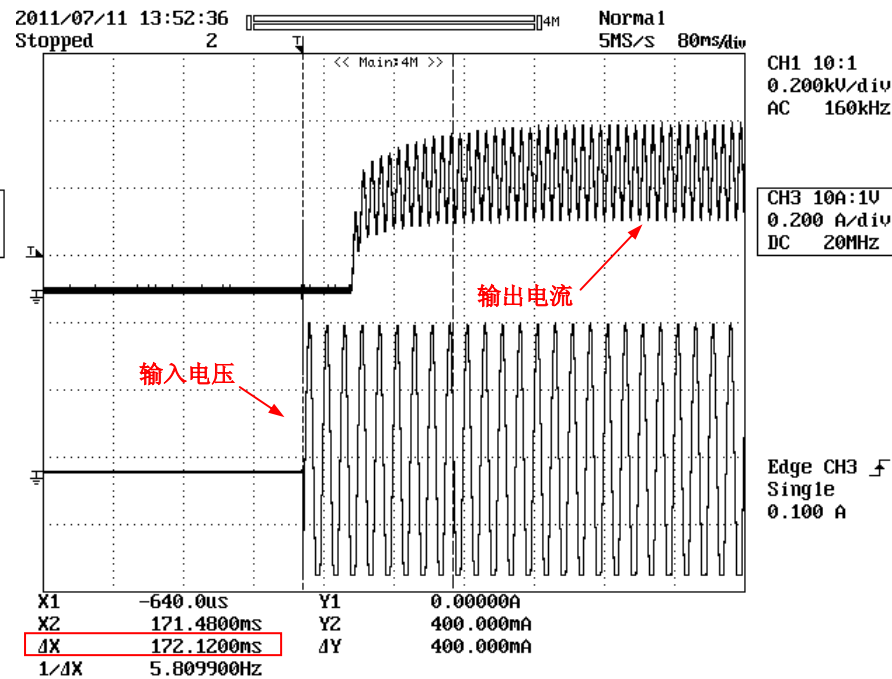

满载, 305Vac电压输入

12. 交流输入电压和电流波形

工程报告 (使用LNK406EG芯片设计的 40V 350mA T8 LED电源) Page 14

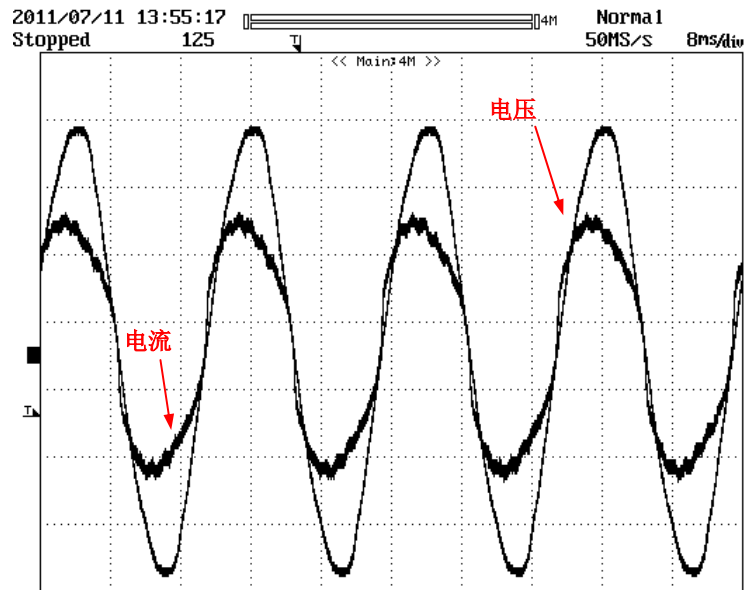

满载, 115Vac电压输入

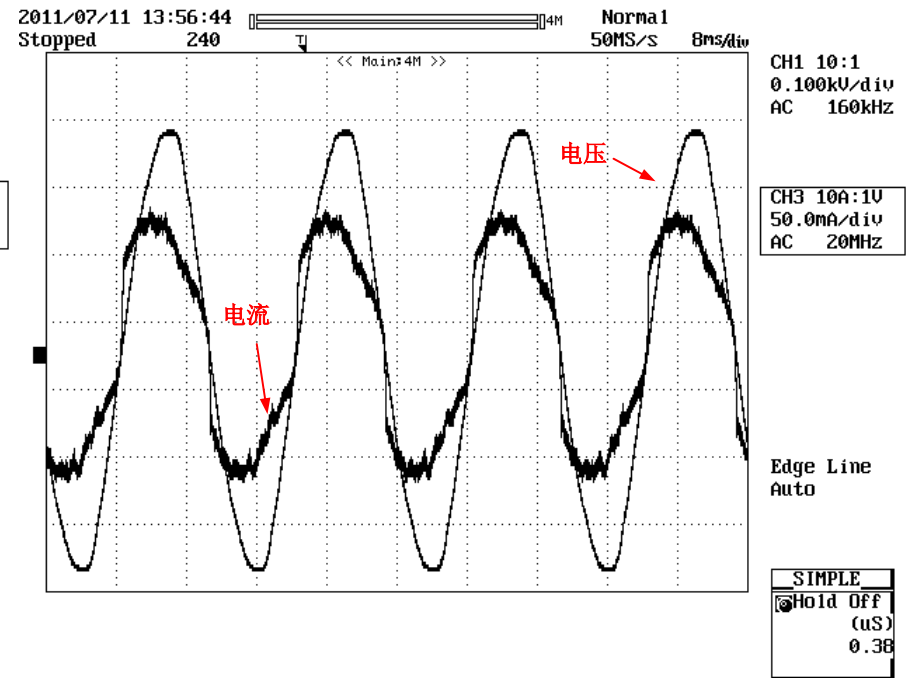

满载, 230Vac电压输入

13. 空载输出电压波形

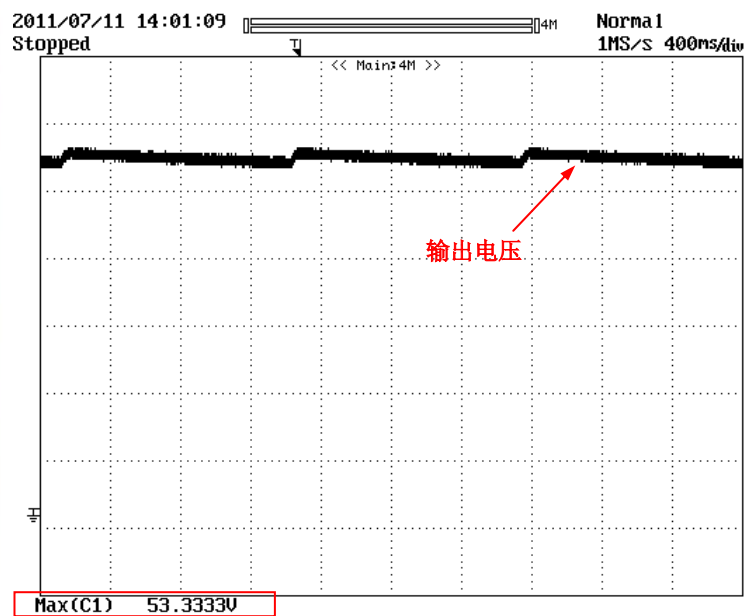

空载测试, 90Vac电压输入

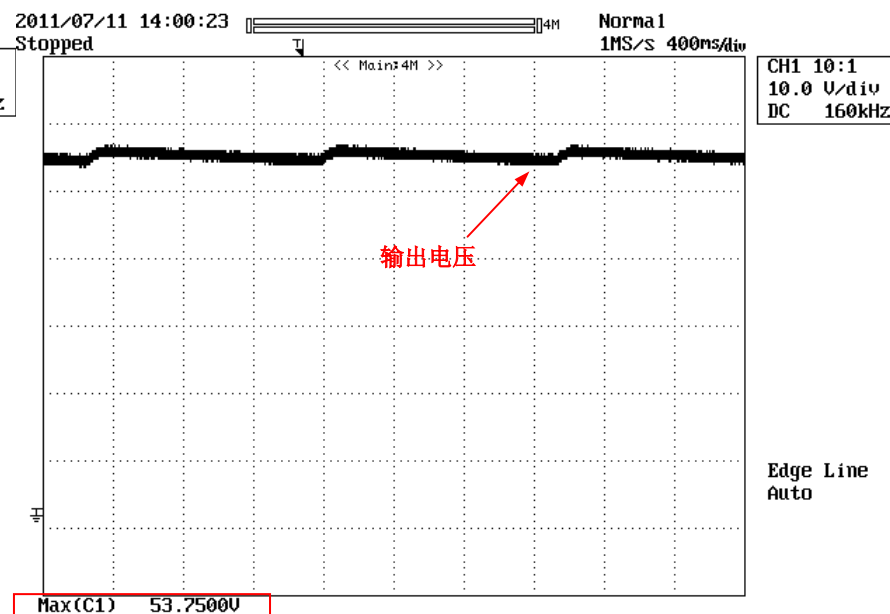

空载测试, 305Vac电压输入

14. 漏极电压应力

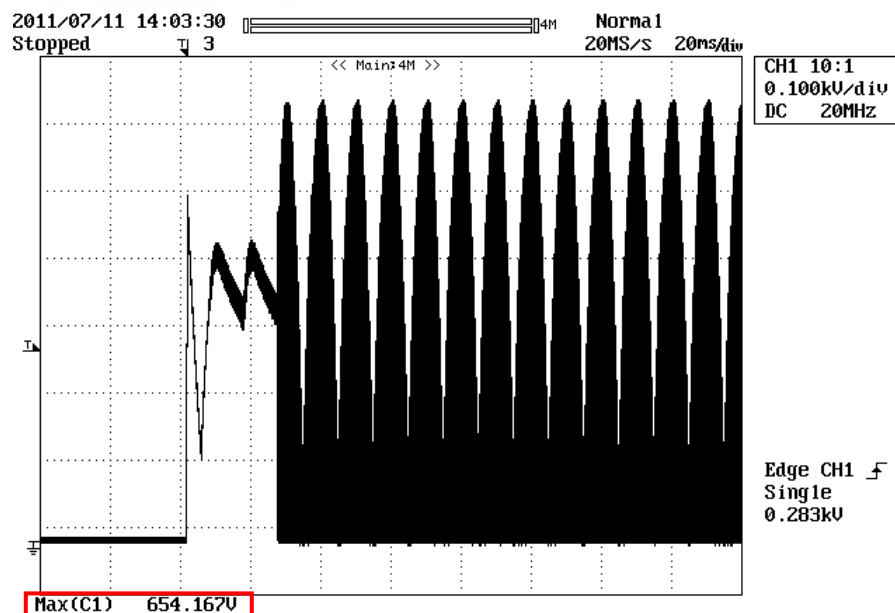

测试条件:
305VAC电压输入
 输出电流**0.35A** (14颗LED串联)

结果: 通过
 最大应力电压=**655V**

LinkSwitch – PH family规格

Absolute Maximum Ratings^(1,4)

DRAIN Pin Peak Current: LNK403	1.37 A
LNK406	2.55 A
LNK409	5.2 A
DRAIN Pin Voltage	-0.3 to 725 V
BYPASS Pin Voltage	-0.3 to 9 V
BYPASS Pin Current	100 mA
VOLTAGE MONITOR Pin Voltage	-0.3 to 9 V
FEEDBACK Pin Voltage	-0.3 to 9 V
REFERENCE Pin Voltage	-0.3 to 9 V
Lead Temperature ⁽³⁾	260 °C
Storage Temperature	-65 to 150 °C
Operating Junction Temperature Over-Score ⁽²⁾	-40 to 150 °C
Lead Temperature Over-Score ⁽³⁾	260 °C

Notes:

1. All voltages referenced to SOURCE, T_A = 25 °C.
2. Normally limited by internal circuitry.
3. 1/16 in. from case for 5 seconds.
4. Absolute Maximum Ratings specified may be applied, one at a time without causing permanent damage to the product. Exposure to Absolute Maximum Ratings for extended periods of time may affect product reliability.

15. 次级整流管电压应力

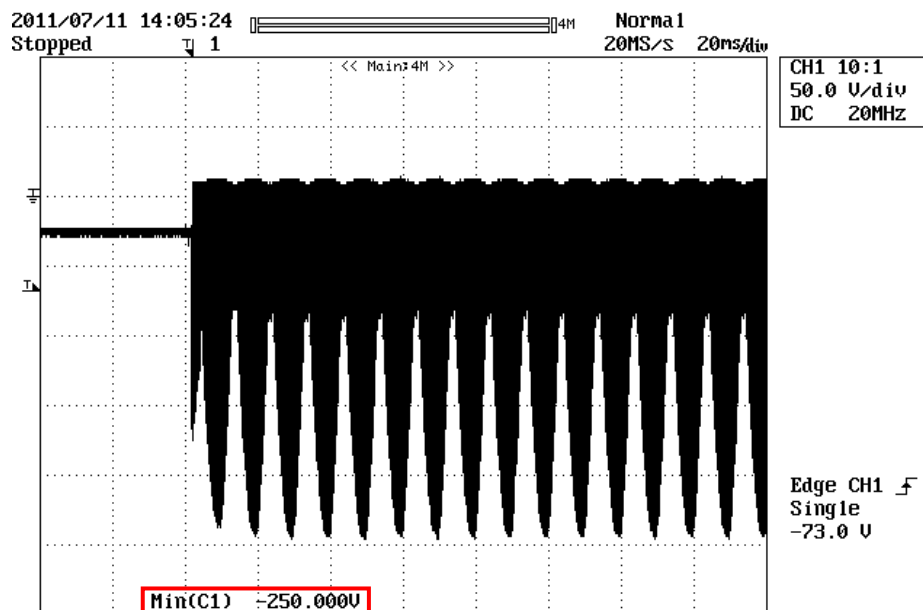

测试条件:
305VAC电压输入
 输出电流**0.35A** (14颗LED串联)

结果: 通过
 最大应力电压=**250V**

次级整流管 (HER204) 规格

Characteristic	Symbol	HER 201	HER 202	HER 203	HER 204	HER 205	HER 206	HER 207	HER 208	Unit
Peak Repetitive Reverse Voltage	VRRM									
Working Peak Reverse Voltage	VRWM	50	100	200	300	400	600	800	1000	V
DC Blocking Voltage	VR									
RMS Reverse Voltage	VR(RMS)	35	70	140	210	280	420	560	700	V
Average Rectified Output Current (Note 1)	Io	2.0								A
	@T _A = 55°C									

16. (1) 传导电磁干扰测试 (115V_{AC}峰值和平均值)

工程报告 (使用LNK406EG芯片设计的 40V 350mA T8 LED电源) Page 18

输出负载为14颗LED串联, 0.35A电流

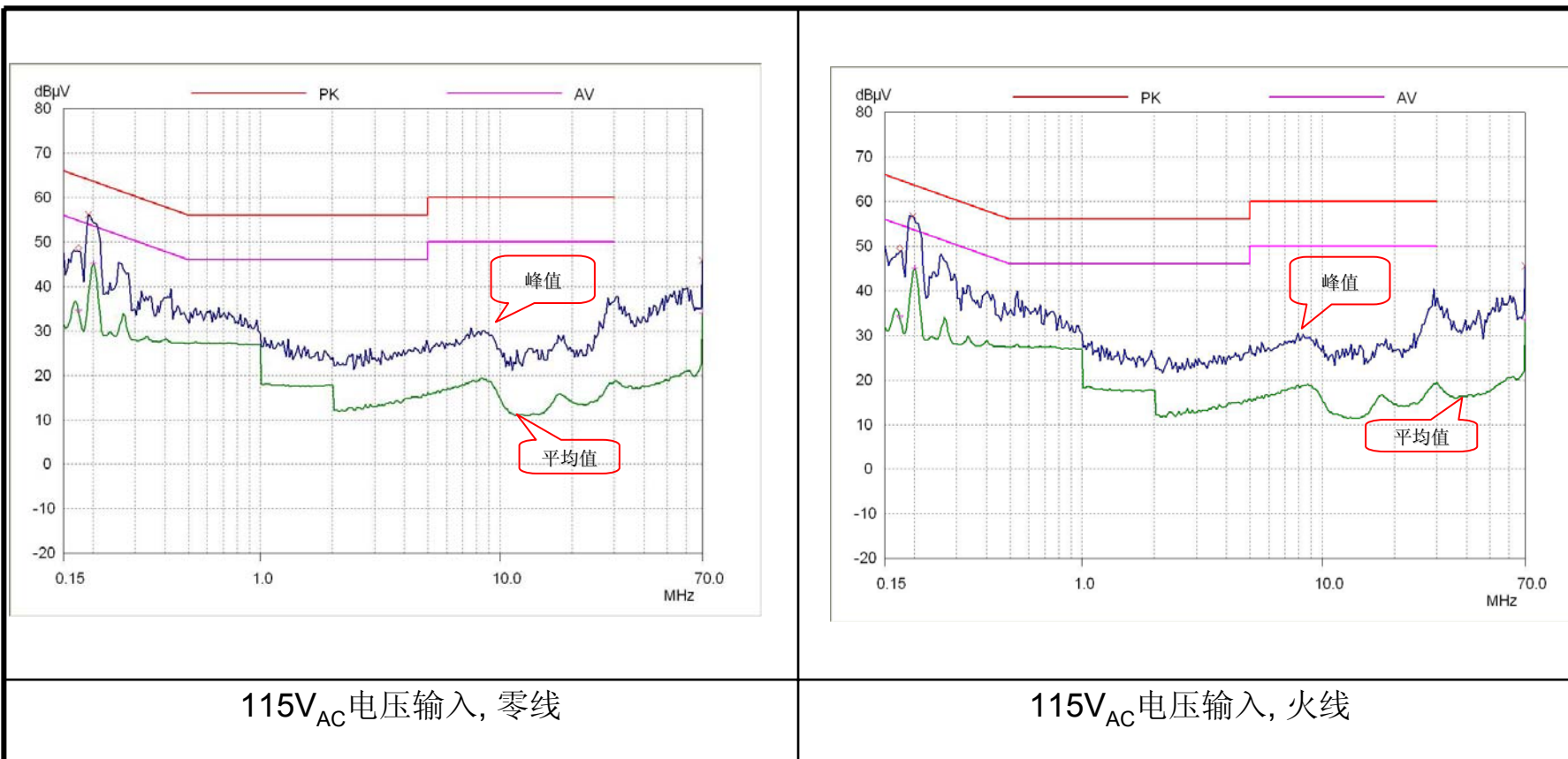

16. (2)传导电磁干扰测试 (230V_{AC}峰值和平均值)

工程报告 (使用LNK406EG芯片设计的 40V 350mA T8 LED电源) Page 19

输出负载为14颗LED串联, 0.35A电流

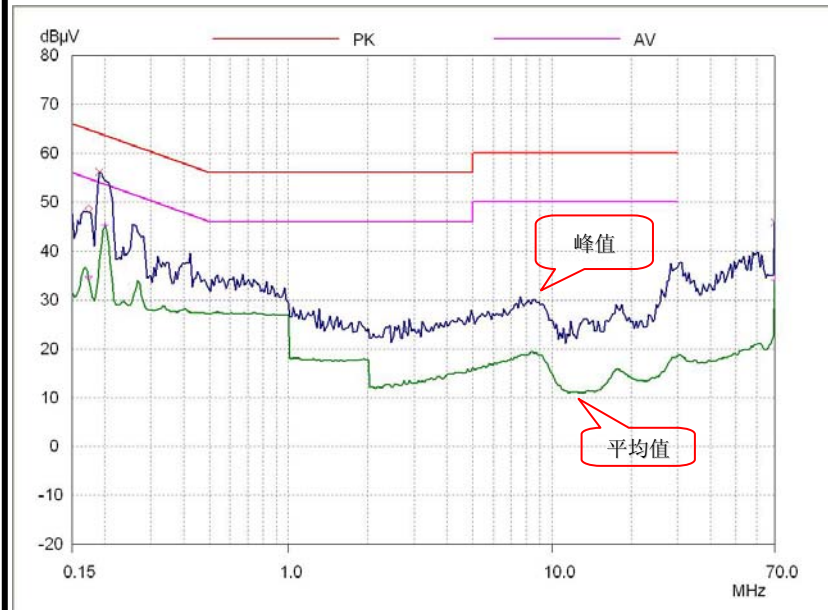

230V_{AC}电压输入, 零线

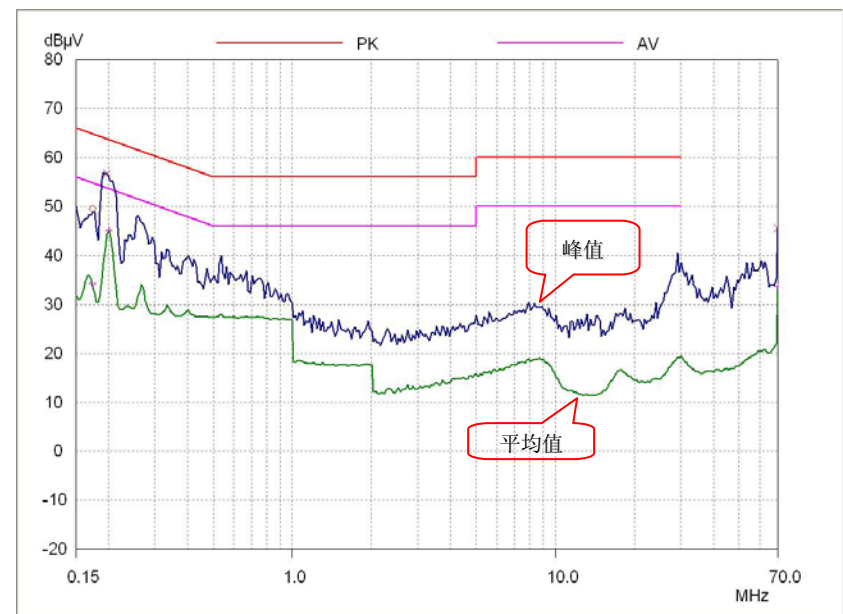

230V_{AC}电压输入, 火线

China Sale Contacts and Important Note

工程报告 (使用LNK406EG芯片设计的 40V 350mA T8 LED电源) Page 20

China Sales Contacts

CHINA (Shanghai)

Room 1601/1610, Tower 1
Kerry Everbright City
No.218 Tianmu Road West
Shanghai, PRC 200070
TEL: +86-21-6354 6323
FAX: +86-21-6354 6325
E-mail: chinasales@powerint.com

CHINA (Shenzhen)

Rooms A, B and C, 4th Floor, Block
C. Electronic Science & Technology
Bldg. 2070 Shennan Zhong Road
Shenzhen, Guangdong
China, 518031
TEL:+86-755-8379-3243
FAX:+86-755-8379-5828
E-mail: chinasales@powerint.com

CHINA (PI Guangzhou Lab)

Room 311,3rd floor, No.9, Jiangong
Road, Tianhe Software Park,
Zhongshan thoroughfare,
Tianhe District, Guangzhou,
China, 510660
TEL:+86 20-8566-4509
FAX:+86 20-8555-1081
E-mail: chinasales@powerint.com

CHINA (PI Chengdu Lab)

Room 1426,Colorful Holiday
Internation Mansion
No.2 Baisi Street,Chengdu,
China, 610016
TEL: +86-28-8676-3012
FAX: +86-28-8676-3011
E-mail: chinasales@powerint.com

中国上海

上海市天目西路218号
嘉里不夜城第一座1601/1610室
邮编: 200070
电话:+86-21-6354 6323
传真:+86-21-6354 6325
电子邮件: chinasales@powerint.com

中国深圳

深圳市深南中路2070号
电子科技大厦C座4楼A,B,C,室
邮编: 518031
电话:+86-755-8379-3243
传真:+86-755-8379-5828
电子邮件: chinasales@powerint.com

中国深圳-广州实验室

广州市天河区中山大道
天河软件园建工路9号3楼311室
邮编:510660
电话:+86-20-8566-4509
传真 +86 20-8555-1081
E-mail: chinasales@powerint.com

中国深圳-成都实验室

四川省成都市白丝街2号
缤纷假日国际公寓1426号
邮编:610016
电话:+
传真:+ 86-28-8676-3012 86-28-8676-
3011
E-mail: chinasales@powerint.com

Important note

Although this board is designed to satisfy safety isolation requirements, the engineering prototype has not been agency approved. Therefore, all testing should be performed using an isolation transformer to provide the AC input to the prototype board.

The products and applications illustrated herein (including circuits external to the products and transformer construction) may be covered by one or more U.S. and foreign patents or potentially by pending U.S. and foreign patent applications assigned to Power Integrations. A complete list of Power Integrations' patents may be found at www.powerint.com.