

### Features

- -100V/-55A,  
 $R_{DS(ON)} = 30m\Omega(Typ.)@V_{GS}=-10V$
- Low On-Resistance
- Super High Dense Cell Design
- Fast Switching and Fully Avalanche Rated
- 100% avalanche tested
- 175°C Operating Temperature
- Lead Free and Green Devices Available (RoHS Compliant)

### Pin Description

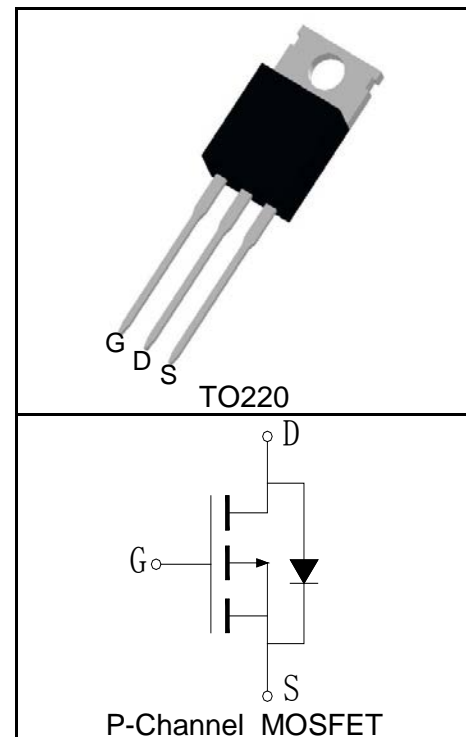

### Applications

- Inverters

### Absolute Maximum Ratings

Symbol	Parameter	Rating	Unit
<b>Common Ratings</b> ( $T_C=25^\circ C$ Unless Otherwise Noted)			
$V_{DSS}$	Drain-Source Voltage	-100	V
$V_{GSS}$	Gate-Source Voltage	$\pm 25$	
$T_J$	Maximum Junction Temperature	175	$^\circ C$
$T_{STG}$	Storage Temperature Range	-55 to 175	$^\circ C$
$I_S$	Diode Continuous Forward Current	$T_C=25^\circ C$ -55	A
<b>Mounted on Large Heat Sink</b>			
$I_{DP}^{①}$	300 $\mu s$ Pulse Drain Current Tested	$T_C=25^\circ C$ -220	A
$I_D^{②}$	Continuous Drain Current( $V_{GS}=-10V$ )	$T_C=25^\circ C$ -55	A
		$T_C=100^\circ C$ -39	
$P_D$	Maximum Power Dissipation	$T_C=25^\circ C$ 176	W
		$T_C=100^\circ C$ 88	
$R_{\theta JC}$	Thermal Resistance-Junction to Case	0.85	$^\circ C/W$
$R_{\theta JA}$	Thermal Resistance-Junction to Ambient	62.5	$^\circ C/W$
<b>Drain-Source Avalanche Ratings</b>			
$E_{AS}^{③}$	Avalanche Energy, Single Pulsed	-	mJ

**Electrical Characteristics** ( $T_C=25^\circ\text{C}$  Unless Otherwise Noted)

Symbol	Parameter	Test Condition	RU1HP55R			Unit
			Min.	Typ.	Max.	
<b>Static Characteristics</b>						
$BV_{DSS}$	Drain-Source Breakdown Voltage	$V_{GS}=0V, I_{DS}=-250\mu A$	-100			V
$I_{DSS}$	Zero Gate Voltage Drain Current	$V_{DS}=-100V, V_{GS}=0V$			-1	$\mu A$
		$T_J=125^\circ C$			-30	
$V_{GS(th)}$	Gate Threshold Voltage	$V_{DS}=V_{GS}, I_{DS}=-250\mu A$	-2		-4	V
$I_{GSS}$	Gate Leakage Current	$V_{GS}=\pm 25V, V_{DS}=0V$			$\pm 100$	nA
$R_{DS(ON)}^{(4)}$	Drain-Source On-state Resistance	$V_{GS}=-10V, I_{DS}=-55A$		30	40	m $\Omega$
<b>Diode Characteristics</b>						
$V_{SD}^{(4)}$	Diode Forward Voltage	$I_{SD}=-55A, V_{GS}=0V$			-1.2	V
$t_{rr}$	Reverse Recovery Time	$I_{SD}=-55A, di_{SD}/dt=100A/\mu s$		150		ns
$Q_{rr}$	Reverse Recovery Charge			500		nC
<b>Dynamic Characteristics</b> <sup>(5)</sup>						
$R_G$	Gate Resistance	$V_{GS}=0V, V_{DS}=0V, F=1MHz$		1.5		$\Omega$
$C_{iss}$	Input Capacitance	$V_{GS}=0V,$ $V_{DS}=-50V,$ Frequency=1.0MHz		3600		pF
$C_{oss}$	Output Capacitance			535		
$C_{riss}$	Reverse Transfer Capacitance			210		
$t_{d(ON)}$	Turn-on Delay Time	$V_{DD}=-50V, I_{DS}=-55A,$ $V_{GEN}=-10V, R_G=6\Omega$		25		ns
$t_r$	Turn-on Rise Time			87		
$t_{d(OFF)}$	Turn-off Delay Time			139		
$t_f$	Turn-off Fall Time			38		
<b>Gate Charge Characteristics</b> <sup>(5)</sup>						
$Q_g$	Total Gate Charge	$V_{DS}=-80V, V_{GS}=-10V,$ $I_{DS}=-55A$		155		nC
$Q_{gs}$	Gate-Source Charge			31		
$Q_{gd}$	Gate-Drain Charge			48		

- Notes:
- ① Pulse width limited by safe operating area.
  - ② Calculated continuous current based on maximum allowable junction temperature.
  - ③ Limited by  $T_{Jmax}$ ,  $I_{AS}=-40A$ ,  $V_{DD}=-60V$ ,  $R_G=50\Omega$ , Starting  $T_J=25^\circ C$ .
  - ④ Pulse test; Pulse width  $\leq 300\mu s$ , duty cycle  $\leq 2\%$ .
  - ⑤ Guaranteed by design, not subject to production testing.

**Ordering and Marking Information**

<b>Device</b>	<b>Marking</b>	<b>Package</b>	<b>Packaging</b>	<b>Quantity</b>	<b>Reel Size</b>	<b>Tape width</b>
RU1HP55R	RU1HP55R	TO220	Tube	50	-	-

**Typical Characteristics**

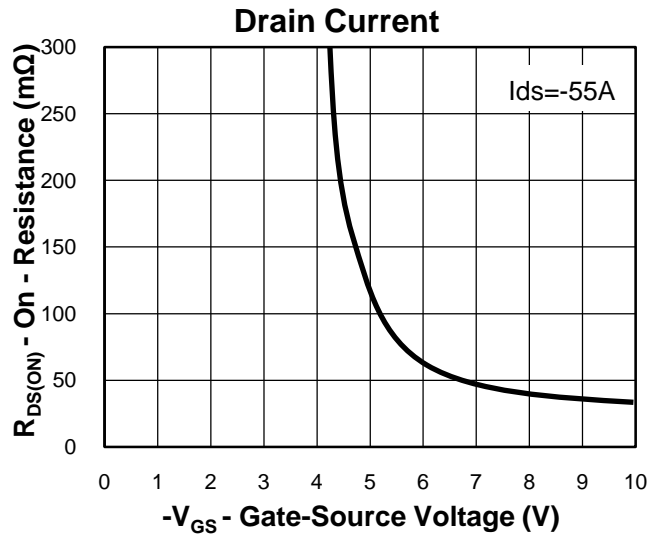
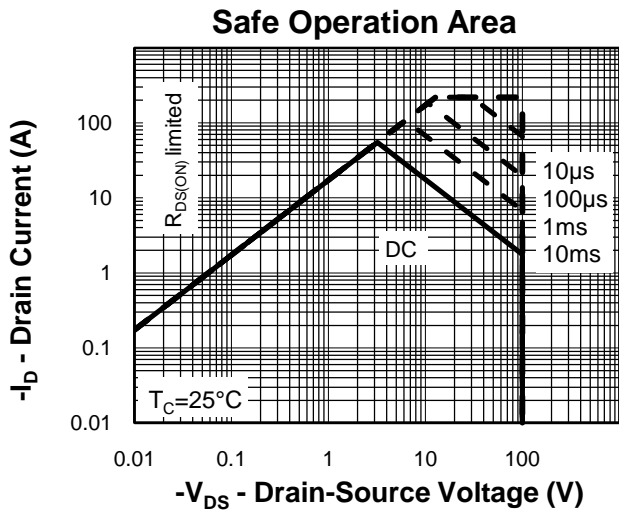
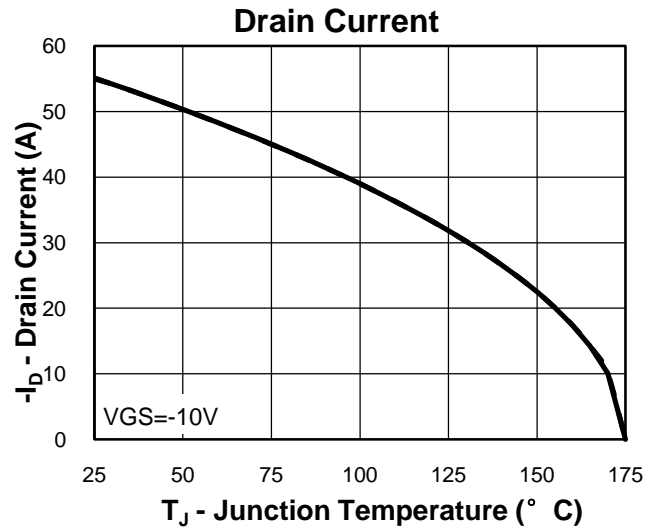
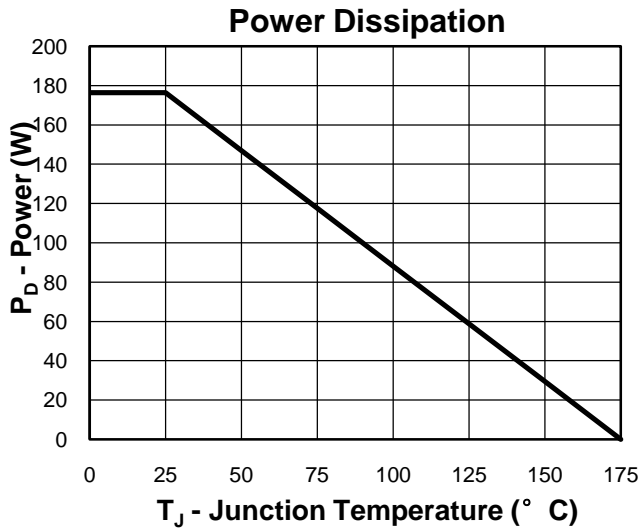

**Thermal Transient Impedance**

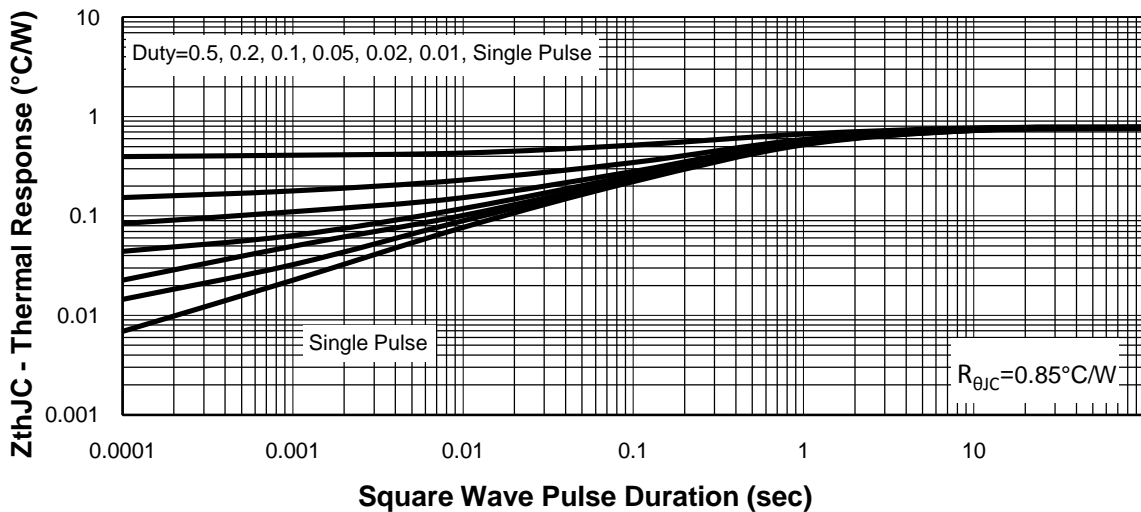

**Typical Characteristics**

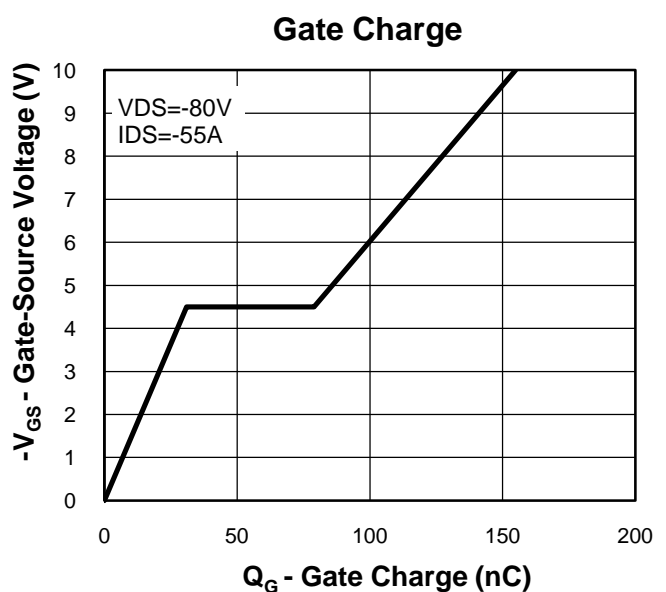
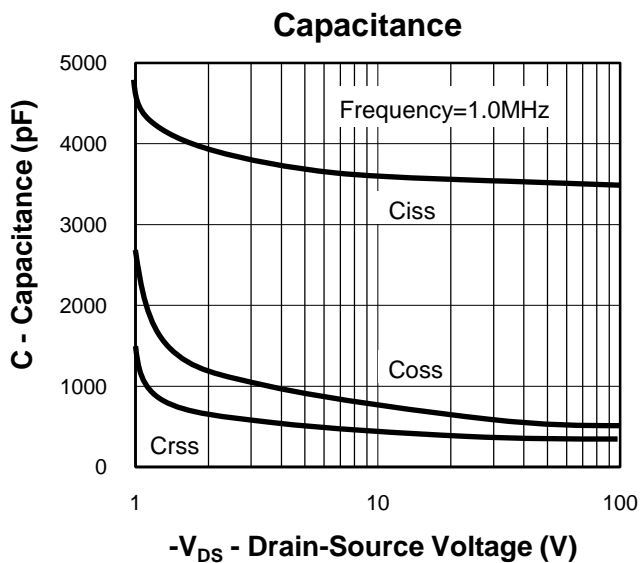
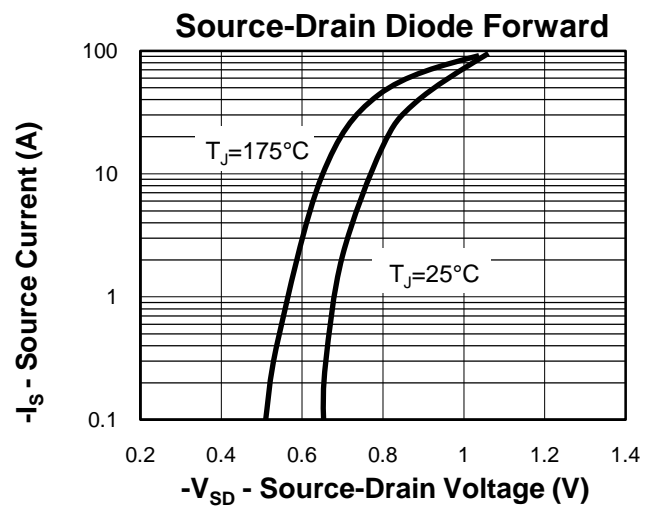
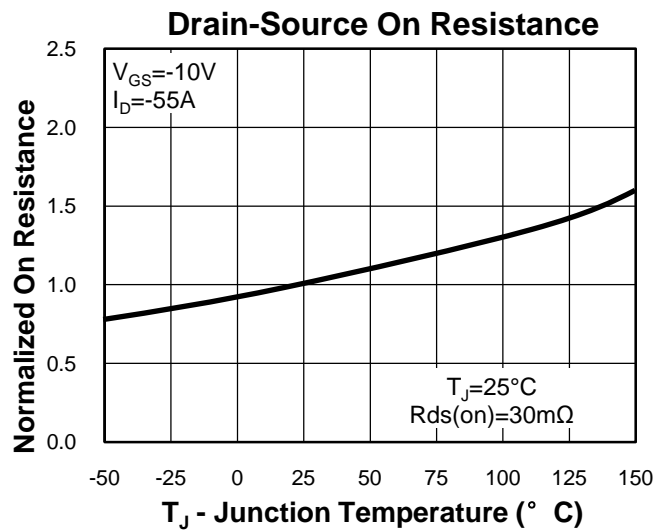
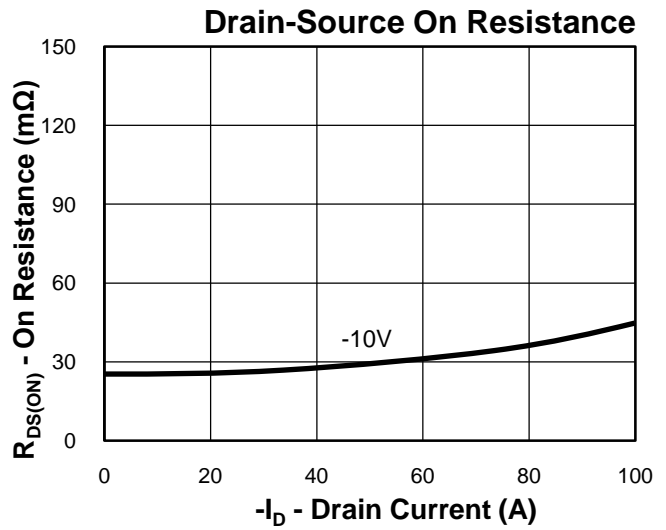
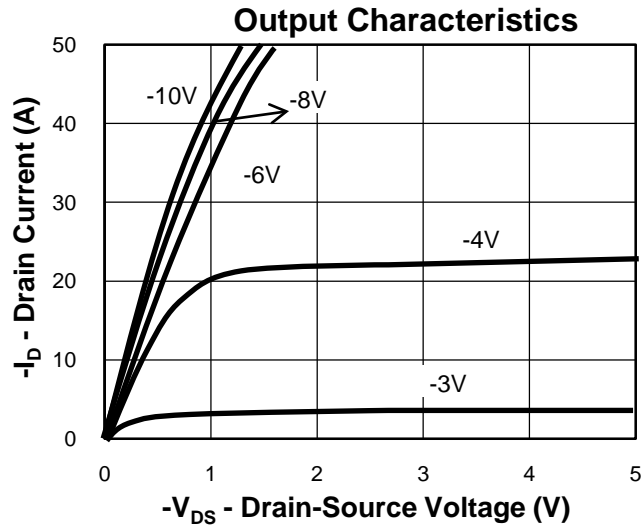

**Avalanche Test Circuit and Waveforms**

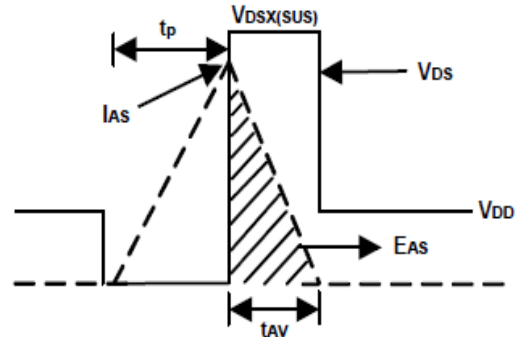
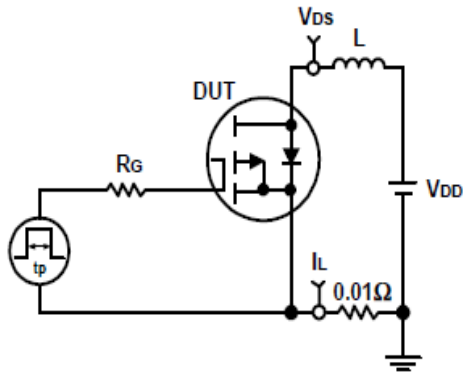

**Switching Time Test Circuit and Waveforms**

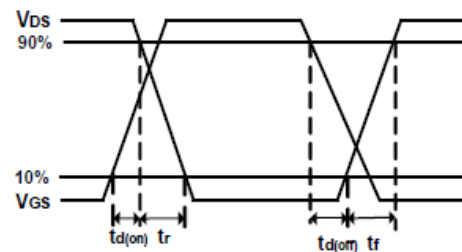
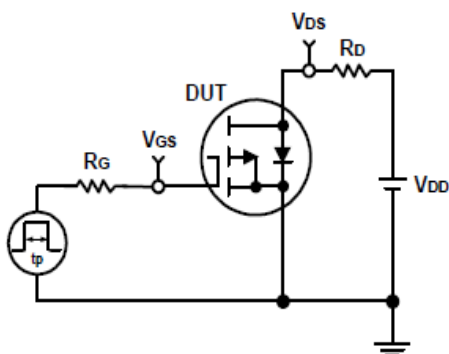

**Package Information**

**TO220**

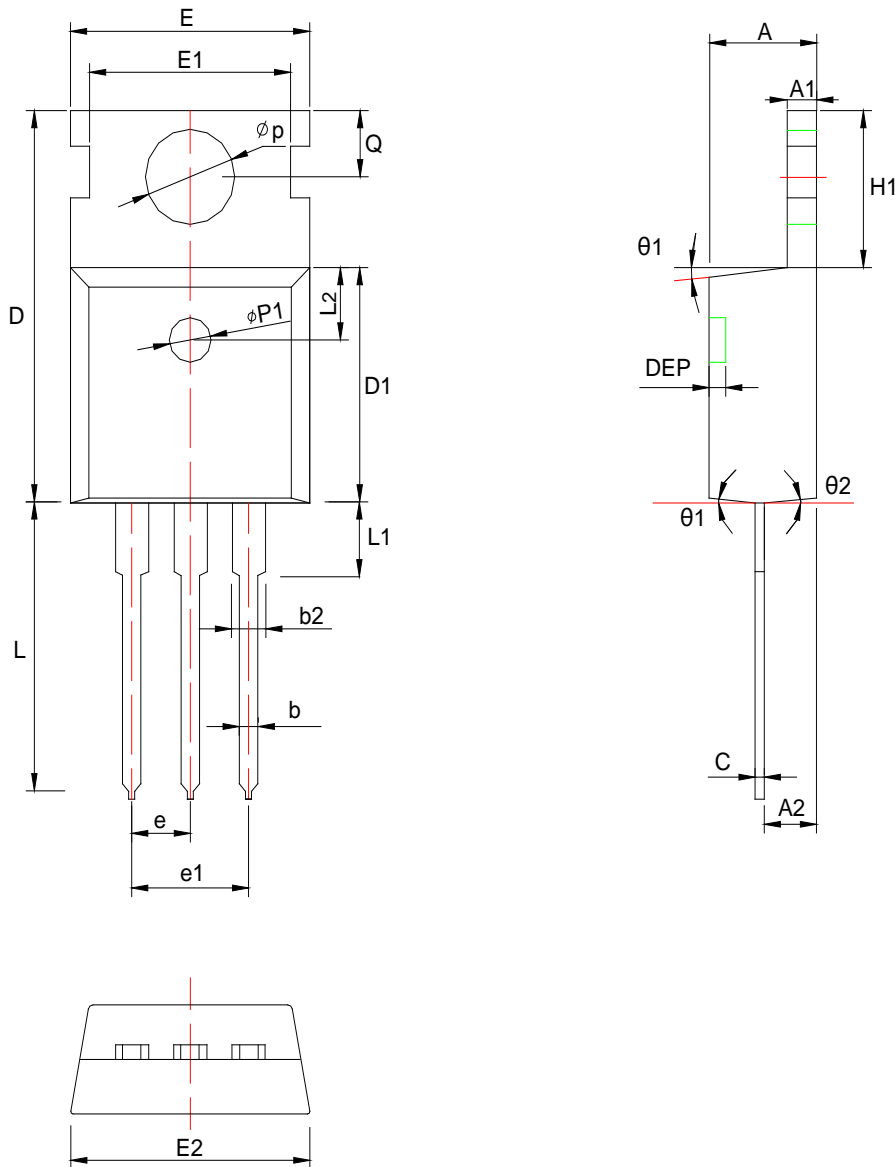

SYMBOL	MM			INCH			SYMBOL	MM			INCH		
	MIN	NOM	MAX	MIN	NOM	MAX		MIN	NOM	MAX	MIN	NOM	MAX
A	4.40	4.55	4.70	0.173	0.179	0.185	$\Phi_{p1}$	1.40	1.50	1.60	0.055	0.059	0.063
A1	1.20	1.30	1.40	0.047	0.051	0.055	e	2.54 BSC			0.10 BSC		
A2	2.23	2.38	2.53	0.088	0.094	0.100	e1	5.08 BSC			0.20 BSC		
b	0.75	0.80	0.85	0.030	0.031	0.033	H1	6.40	6.50	6.60	0.252	0.256	0.260
b2	1.17	1.28	1.39	0.046	0.050	0.055	L	12.70	13.18	13.65	0.500	0.519	0.537
c	0.40	0.50	0.60	0.016	0.020	0.024	L1	*	*	3.95	*	*	0.156
D	15.40	15.60	15.80	0.606	0.614	0.622	L2	2.50 REF			0.098 REF		
D1	8.96	9.21	9.46	0.353	0.363	0.372	$\Phi_p$	3.50	3.60	3.70	0.138	0.142	0.146
DEP	0.05	0.13	0.20	0.002	0.005	0.008	Q	2.73	2.80	2.87	0.107	0.110	0.113
E	9.66	9.97	10.28	0.380	0.393	0.405	$\theta_1$	5°	7°	9°	5°	7°	9°
E1	*	8.70	*	*	0.343	*	$\theta_2$	1°	3°	5°	1°	3°	5°
E2	9.80	10.00	10.20	0.386	0.394	0.402							

**Customer Service****Worldwide Sales and Service:**

Sales@ruichips.com

**Technical Support:**

Technical@ruichips.com

**Investor Relations Contacts:**

Investor@ruichips.com

**Marcom Contact:**

Marcom@ruichips.com

**Editorial Contact:**

Editorial@ruichips.com

**HR Contact:**

HR@ruichips.com

**Legal Contact:**

Legal@ruichips.com

**Shen Zhen RUICHIPS Semiconductor CO., LTD**

Room 501, the 5floor An Tong Industrial Building,  
NO.207 Mei Hua Road Fu Tian Area Shen Zhen City, CHINA

**TEL:** (86-755) 8311-5334

**FAX:** (86-755) 8311-4278

**E-mail:** Sales-SZ@ruichips.com