

High Efficiency 1.2MHz 2A Step Up Converter

❖ GENERAL DESCRIPTION

The AX5523 is a constant frequency, 6-pin SOT23 current mode step-up converter intended for small, low power applications. The AX5523 switches at 1.2MHz and allows the use of tiny, low cost capacitors and inductors 2mm or less in height. Internal soft-start results in small inrush current and extends battery life.

The AX5523 features automatic shifting to pulse frequency modulation mode at light loads. The AX5523 includes under-voltage lockout, current limiting, and thermal overload protection to prevent damage in the event of an output overload. The AX5523 is available in a small 6-pin SOT-23 package.

❖ FEATURES

- Integrated 80mΩ Power MOSFET
- 2V to 24V Input Voltage
- 1.2MHz Fixed Switching Frequency
- Internal 4A Switch Current Limit
- Adjustable Output Voltage
- Internal Compensation
- Up to 28V Output Voltage
- Automatic Pulse Frequency Modulation Mode at Light Loads
- up to 97% Efficiency
- Available in a 6-Pin SOT23-6 package

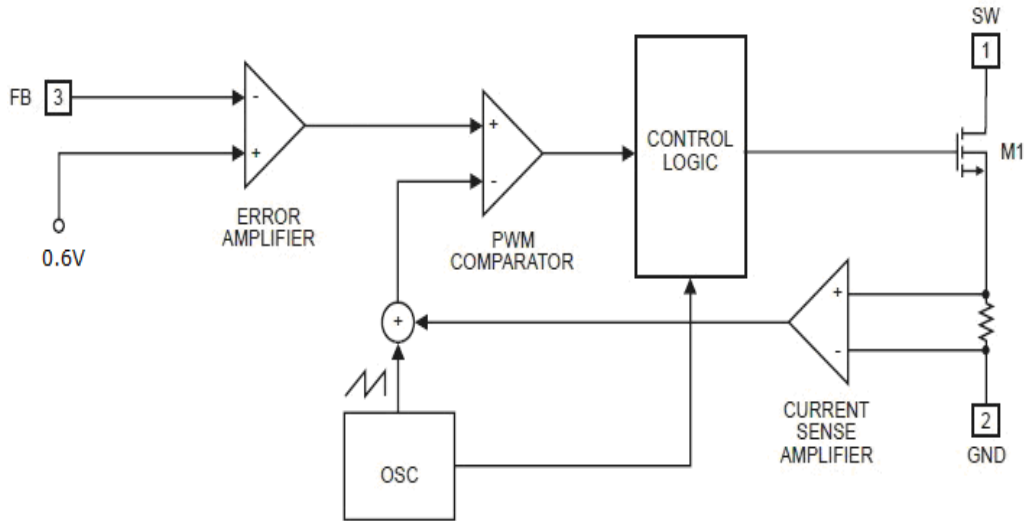
❖ BLOCK DIAGRAM

❖ PIN ASSIGNMENT

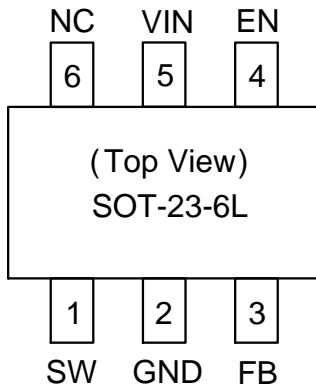
The packages of AX5523 is SOT-23-6L; the pin assignment is given by:



Name	Description
SW	Power Switch Output. SW is the drain of the internal MOSFET switch. Connect the power inductor and output rectifier to SW. SW can swing between GND and 28V.
GND	Analog Ground pin.
FB	Feedback Input. The FB voltage is 0.6V. Connect a resistor divider to FB.
EN	Regulator On/Off Control Input. A high input at EN turns on the converter, and a low input turns it off. When not used, connect EN to the input supply for automatic startup.
VIN	Input Supply Pin. Must be locally bypassed.
NC	NC

❖ ORDER/MARKING INFORMATION

Order Information	Top Marking (SOT-23-6L)
<p>AX5523 X X</p> <p>Package Type C: SOT23-6L</p> <p>Packing Blank : Tube A : Taping</p>	<p>L L Y W X → ID code: internal</p> <p>→ WW: 01~26 (A~Z) 27~52 (a~z)</p> <p>→ Year: 2=2012 3=2013 ⋮ 9=2019</p> <p>W2 : AX5523</p>

❖ ABSOLUTE MAXIMUM RATINGS

Characteristics	Rating	Unit
IN, EN voltages	-0.3 to 26	V
SW Voltage	-0.3 to 30	V
Operating Temperature	-40 to +85	°C
Storage Temperature Range	-65 to +150	°C
FB Voltages	-0.3 to 6	V
Peak SW Sink and Source Current	4	A
Junction Temperature	160	°C
Lead Temperature (Soldering, 10s)	+300	°C

❖ ELECTRICAL CHARACTERISTICS

($V_{IN}=V_{EN}=5V$, $T_A = 25^\circ C$, unless otherwise noted.)

Characteristics	Conditions	Min	Typ	Max	Units
Operating Input Voltage		2		24	V
Under Voltage Lockout				1.98	V
Under Voltage Lockout Hysteresis			100		mV
Current (Shutdown)	$V_{EN}=0V$		0.1	1	μA
Quiescent Current (PFM)	$V_{FB}=0.7V$, No switch		100	200	μA
Quiescent Current (PWM)	$V_{FB}=0.5V$, switch		1.6	2.2	mA
Switching Frequency			1.2		MHz
Maximum Duty Cycle	$V_{FB} = 0V$	90			%
EN Input High Voltage		1.5			V
EN Input Low Voltage				0.4	V
FB Voltage		0.588	0.6	0.612	V
FB Input Bias Current	$V_{FB} = 0.6V$	-50	-10		nA
SW On Resistance (1)			80	150	m Ω
SW Current Limit (1)	$V_{IN}=5V$, Duty cycle=50%		4		A
SW Leakage	$V_{SW} = 20V$			1	μA
Thermal Shutdown			155		°C

Note 1: Guaranteed by design, not tested.

❖ APPLICATION CIRCUIT

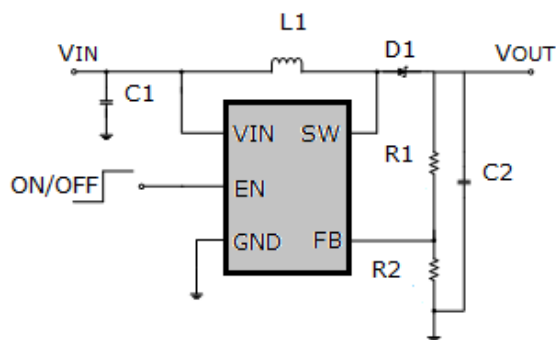

Basic Application Circuit

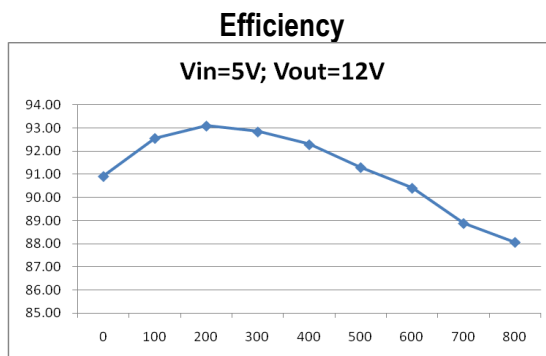

The efficiency Curve

❖ FUNCTION DESCRIPTION

The AX5523 uses a fixed frequency, peak current mode boost regulator architecture to regulate voltage at the feedback pin. The operation of the AX5523 can be understood by referring to the block diagram of Figure 3. At the start of each oscillator cycle the MOSFET is turned on through the control circuitry. To prevent sub-harmonic oscillations at duty cycles greater than 50 percent, a stabilizing ramp is added to the output of the current sense amplifier and the result is fed into the negative input of the PWM comparator. When this voltage equals the output voltage of the error amplifier the power MOSFET is turned off. The voltage at the output of the error amplifier is an amplified version of the difference between the 0.6V bandgap reference voltage and the feedback voltage. In this way the peak current level keeps the output in regulation. If the feedback voltage starts to drop, the output of the error amplifier increases. These results in more current to flow through the power MOSFET, thus increasing the power delivered to the output. The AX5523 has internal soft start to limit the amount of input current at startup and to also limit the amount of overshoot on the output.

❖ APPLICATION INFORMATION

Setting the Output Voltage

The internal reference VREF is 0.6V (Typical).The output voltage is divided by a resistor divider,R1 and R2 to the FB pin. The output voltage is given by

$$V_{OUT} = V_{REF} \times \left(1 + \frac{R_1}{R_2}\right)$$

Inductor Selection

The recommended values of inductor are 4.7 to 22μH. Small size and better efficiency are the major concerns for portable device, such as AX5523 used for mobile phone. The inductor should have low core loss at 1.2MHz and low DCR for better efficiency. To avoid inductor saturation current rating should be considered.

Capacitor Selection

Input and output ceramic capacitors of 22μF are recommended for AX5523 applications. For better voltage filtering, ceramic capacitors with low ESR are recommended. X5R and X7R types are suitable because of their wider voltage and temperature ranges.

Diode Selection

Schottky diode is a good choice for AX5523 because of its low forward voltage drop and fast reverses recovery. Using Schottky diode can get better efficiency. The high speed rectification is also a good characteristic of Schottky diode for high switching frequency. Current rating of the diode must meet the root mean square of the peak current and output average current multiplication as following:

$$I_D (RMS) \approx \sqrt{I_{OUT} \times I_{PEAK}}$$

The diode' s reverse breakdown voltage should be larger than the output voltage.

PCB Layout Recommendations

When laying out the printed circuit board, the following checking should be used to ensure proper operation of the PCT3408. Check the following in your layout:

1. The power traces, consisting of the GND trace, the SW trace and the VIN trace should be kept short, direct and wide.
2. Does the (+) plates of Cin connect to Vin as closely as possible. This capacitor provides the AC current to the internal power MOSFETs.
3. Keep the switching node SW away from the sensitive VOUT node.
4. Keep the (-) plates of Cin and Cout as close as possible.

❖ TYPICAL CHARACTERISTICS

Efficiency Curve

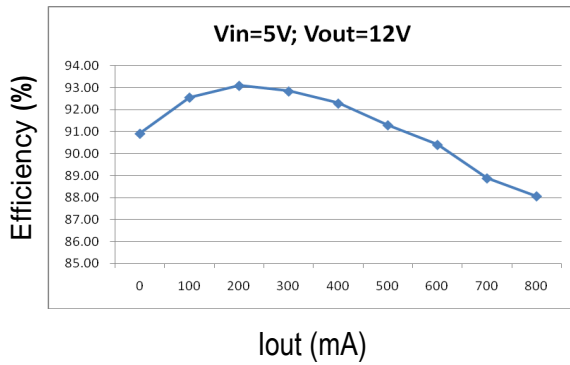

Efficiency Curve

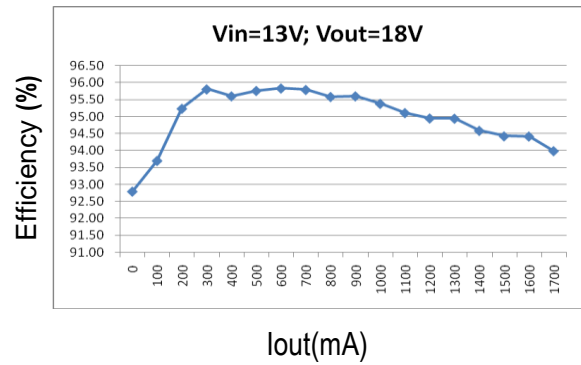

line Regulation

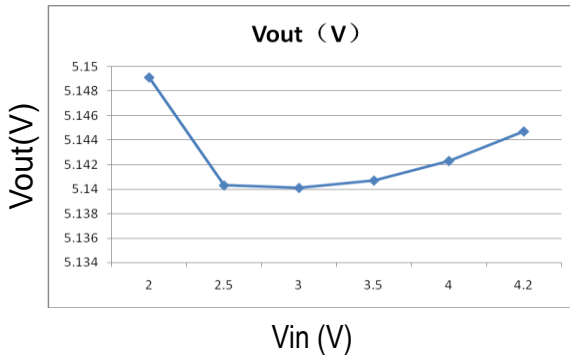

Load regulation

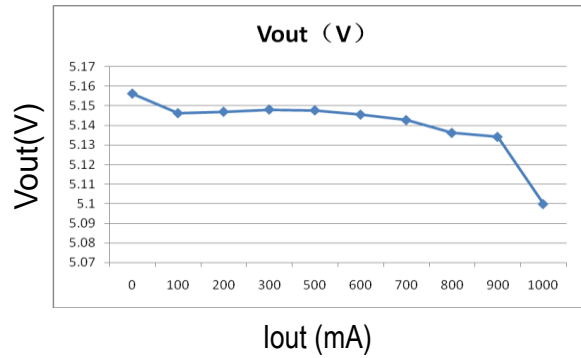

Freq VS Vin

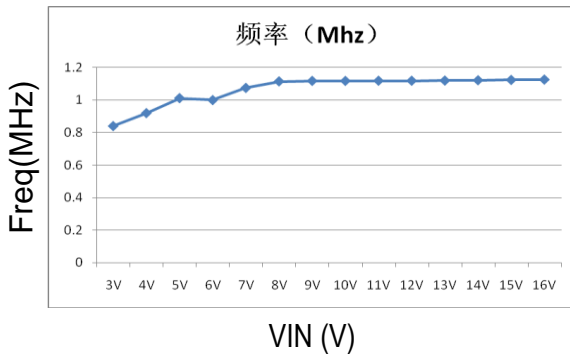

Efficiency VS Vin

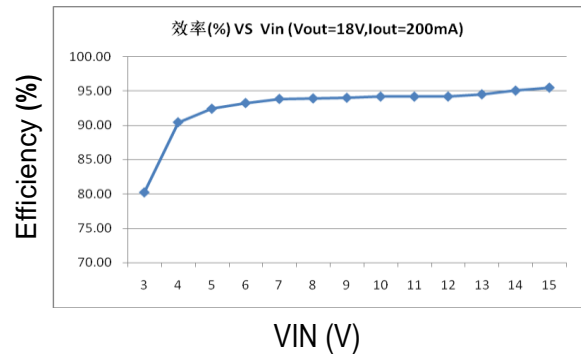

❖ **PACKAGE OUTLINES**

(1) **SOT-23-6L**

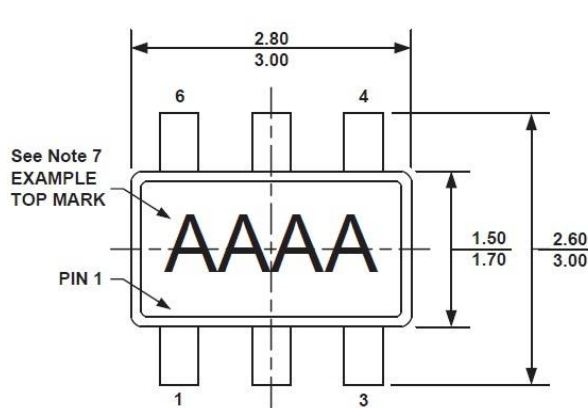

TOP VIEW

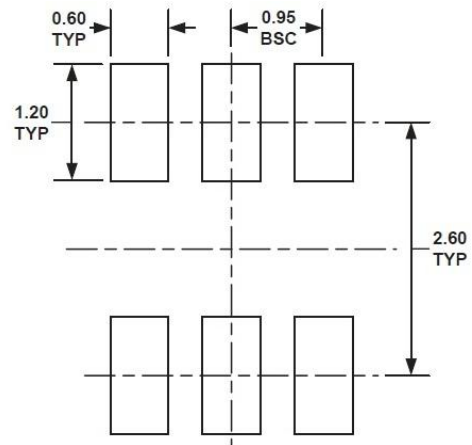

RECOMMENDED LAND PATTERN

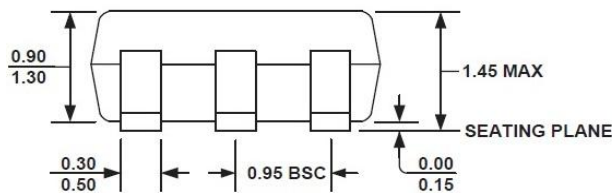

FRONT VIEW

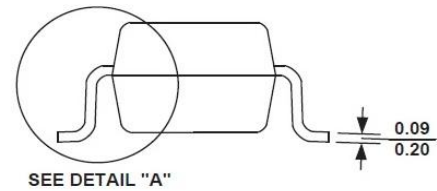

SIDE VIEW

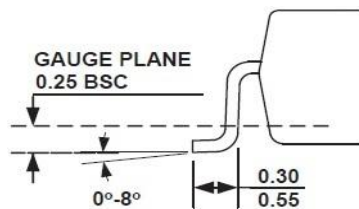

DETAIL "A"

NOTE:

- 1) ALL DIMENSIONS ARE IN MILLIMETERS.
- 2) PACKAGE LENGTH DOES NOT INCLUDE MOLD FLASH, PROTRUSION OR GATE BURR.
- 3) PACKAGE WIDTH DOES NOT INCLUDE INTERLEAD FLASH OR PROTRUSION.
- 4) LEAD COPLANARITY (BOTTOM OF LEADS AFTER FORMING) SHALL BE 0.10 MILLIMETERS MAX.
- 5) DRAWING CONFORMS TO JEDEC MO-193, VARIATION AB.
- 6) DRAWING IS NOT TO SCALE.
- 7) PIN 1 IS LOWER LEFT PIN WHEN READING TOP MARK FROM LEFT TO RIGHT, (SEE EXAMPLE TOP MARK)