Fast Ultra High-PSRR, Low-Noise, Low-Dropout, 600mA Micropower CMOS Linear Regulator

General Description

The EMP8965 low-dropout (LDO) CMOS linear regulators feature ultra-high power supply rejection ratio (75dB at 1kHz), low output voltage noise (30 μ V), low dropout voltage (270mV), low quiescent current (110 μ A), and fast transient response. It guarantees delivery of 600mA output current, and supports preset output voltages ranging from 1.2V to 3.3V with 0.1V increment (except for 1.85V and 2.85V).

The EMP8965 is ideal for battery-powered applications by virtue of its low quiescent current consumption and its 1nA shutdown mode of logical operation. The regulator provides fast turn-on and start-up time by using dedicated circuitry to pre-charge an optional external bypass capacitor. This bypass capacitor is used to reduce the output voltage noise without adversely affecting the load transient response. The high power supply rejection ratio of the EMP8965 holds well for low input voltages typically encountered in battery-operated systems. The regulator is stable with small ceramic capacitive loads (2.2 μ F typical).

Additional features include regulation fault detection, bandgap voltage reference, constant current limiting and thermal overload protection. Available in miniature 5-pin SOT-89-5 package options, SOT-23-5 and SOT-23-6

package options are also offered to provide additional flexibility for different applications.

EMP products is RoHS compliant.

Features

- Miniature SOT-23-5, SOT-23-6 and SOT-89-5 packages
- 600mA guaranteed output current
- 75dB typical PSRR at 1kHz
- 30 μ V RMS output voltage noise (10Hz to 100kHz)
- 270mV typical dropout at 600mA
- 110 μ A typical quiescent current
- 1nA typical shutdown mode
- Fast line and load transient response
- 80 μ s typical fast turn-on time
- 2.5V to 5.5V input range
- Stable with small ceramic output capacitors
- Over temperature and over current protection
- \pm 2% output voltage tolerance

Applications

- Wireless handsets
- PCMCIA cards
- DSP core power
- Hand-held instruments
- Battery-powered systems
- Portable information appliances

Connection Diagrams

SOT-23-5(Top View)

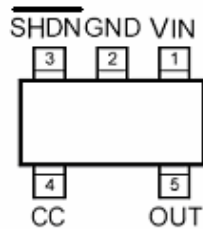

SOT-23-6(Top View)

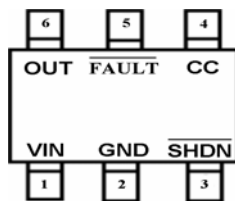

SOT-89-5(Top View)

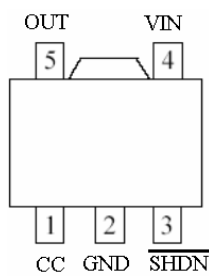

Order information

EMP8965-XXVF05GRR/NRR

XX	Operation Code
VF05	SOT-23-5 Package
GRR	RoHS (Pb Free)
	Rating: -40 to 85°C
	Package in Tape & Reel
NRR	RoHS & Halogen free (By Request)
	Rating: -40 to 85°C
	Package in Tape & Reel

EMP8965-XXVC06GRR/NRR

XX	Operation Code
VC06	SOT-23-6 Package
GRR	RoHS (Pb Free)
	Rating: -40 to 85°C
	Package in Tape & Reel
NRR	RoHS & Halogen free (By Request)
	Rating: -40 to 85°C
	Package in Tape & Reel

EMP8965-XXVG05GRR/NRR

XX	Operation Code
VG05	SOT-89-5 Package
GRR	RoHS (Pb Free)
	Rating: -40 to 85°C
	Package in Tape & Reel
NRR	RoHS & Halogen free (By Request)
	Rating: -40 to 85°C
	Package in Tape & Reel

Order, Mark & Packing Information

No. of PIN	Fixed	EN	CC	Fault	Package	Marking	Vout Code (XX)	Vout	Product ID
5	Y	Y	Y	N	SOT-23-5		12	1.2	EMP8965-12VF05GRR
							15	1.5	EMP8965-15VF05GRR
							18	1.8	EMP8965-18VF05GRR
							25	2.5	EMP8965-25VF05GRR
							30	3.0	EMP8965-30VF05GRR
							33	3.3	EMP8965-33VF05GRR
5	Y	Y	Y	N	SOT-89-5		12	1.2	By request
							15	1.5	By request
							18	1.8	EMP8965-18VG05GRR
							25	2.5	EMP8965-25VG05GRR
							30	3.0	By request
							33	3.3	EMP8965-33VG05GRR
6	Y	Y	Y	Y	SOT-23-6		12	1.2	EMP8965-12VC06GRR
							15	1.5	EMP8965-15VC06GRR
							18	1.8	EMP8965-18VC06GRR
							25	2.5	By request
							30	3.0	By request
							33	3.3	EMP8965-33VC06GRR

Old Marking: please see the notice(Page 18)

Package & Packing

SOT-23-5	3K units Tape & Reel
SOT-23-6	3K units Tape & Reel
SOT-89-5	1K units Tape & Reel

Typical Application

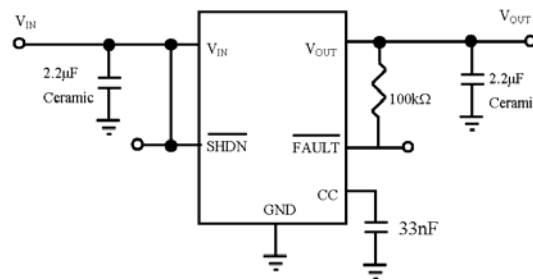

Fig. 1. EMP8965 with Fault. Fixed output version.

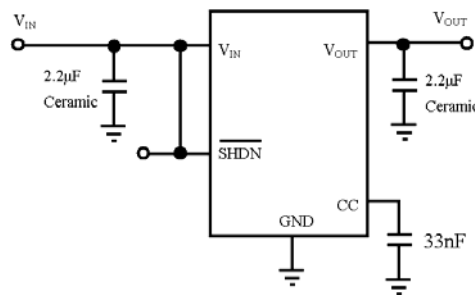

Fig. 2. EMP8965. Fixed output version.

Pin Functions

Name	SOT-23-5	SOT-89-5	SOT-23-6	Function
VOUT	5	5	6	Output Voltage Feedback.
VIN	1	4	1	Supply Voltage Input. Require a minimum input capacitor of close to 1 μ F to ensure stability and sufficient decoupling from the ground pin.
GND	2	2	2	Ground Pin.
CC	4	1	4	Compensation Capacitor. Connect an optimum 33nF noise bypass capacitor between the CC and the ground pins to reduce noise in VOUT.
$\overline{\text{SHDN}}$	3	3	3	Shutdown Input. Set the regulator into the disable mode by pulling the $\overline{\text{SHDN}}$ pin low. To keep the regulator on during normal operation, connect the $\overline{\text{SHDN}}$ pin to VIN. The $\overline{\text{SHDN}}$ pin must not exceed VIN under all operating conditions.
$\overline{\text{FAULT}}$			5	Fault Detection Output. The $\overline{\text{FAULT}}$ pin goes low when the voltage regulating function fails. Because the $\overline{\text{FAULT}}$ pin connects to the open-drain output of a NMOS transistor, a typical 100k Ω pull-up resistor is required to provide the necessary output voltage. The $\overline{\text{FAULT}}$ pin enters the high impedance state during shutdown and it should be connected to ground if unused.

Absolute Maximum Ratings (Notes 1, 2)

V _{IN} , V _{OUT} , V _{SHDN} , V _{SET} , V _{CC} , V _{FAULT}	-0.3V to 6.0V	Thermal Resistance (θ _{JA}) (Note 3)	
Power Dissipation	(Note 3)	SOT-23-5	250°C/W
Storage Temperature Range	-65°C to 160°C	SOT-23-6	250°C/W
Junction Temperature (T _J)	150°C	SOT-89-5	100°C/W
Lead Temperature (10 sec.)	260°C		
ESD Rating		Operating Ratings (Note 1), (Note 2)	
Human Body Model (Note 5)	2kV	Temperature Range	-40°C to 85°C
MM	200V	Supply Voltage	2.5V to 5.5V

Electrical Characteristics

Unless otherwise specified, all limits guaranteed for V_{IN} = V_{OUT} + 1V (Note 6), V_{SHDN} = V_{IN}, C_{IN} = C_{OUT} = 2.2μF, C_{CC} = 33nF, T_J = 25°C. **Boldface** limits apply for the operating temperature extremes: -40°C and 85°C.

Symbol	Parameter	Conditions	Min	Typ (Note 7)	Max	Units
V _{IN}	Input Voltage		2.5		5.5	V
ΔV _{OTL}	Output Voltage Tolerance	100μA ≤ I _{OUT} ≤ 300mA V _{OUT (NOM)} + 0.5V ≤ V _{IN} ≤ 5.5V (Note 6)	-2		+2	% of V _{OUT (NOM)}
			-3		+3	
I _{OUT}	Maximum Output Current	Average DC Current Rating	600			mA
I _{LIMIT}	Output Current Limit (SOT-23-5, SOT-23-6)		600	950		mA
	Output Current Limit (SOT-89-5)		630	950		mA
I _Q	Supply Current	I _{OUT} = 0mA		110		μA
		I _{OUT} = 600mA		255		
	Shutdown Supply Current	V _{OUT} = 0V, $\overline{\text{SHDN}}$ = GND		0.001	1	
V _{DO}	Dropout Voltage (Note 4), (Note 6)	I _{OUT} = 50mA		22		mV
		I _{OUT} = 300mA		130		
		I _{OUT} = 600mA		270		
ΔV _{OUT}	Line Regulation	I _{OUT} = 1mA, (V _{OUT} + 0.5V) ≤ V _{IN} ≤ 5.5V (Note 7)	-0.1	0.02	0.1	%/V
	Load Regulation	100μA ≤ I _{OUT} ≤ 600mA		0.001		%/mA
e _n	Output Voltage Noise	I _{OUT} = 10mA, 10Hz ≤ f ≤ 100kHz		30		μV _{RMS}
V _{SHDN}	$\overline{\text{SHDN}}$ Input Threshold	V _{IH} , (V _{OUT} + 0.5V) ≤ V _{IN} ≤ 5.5V (Note 6)	1.2			V
		V _{IL} , (V _{OUT} + 0.5V) ≤ V _{IN} ≤ 5.5V (Note 6)			0.4	
I _{SHDN}	$\overline{\text{SHDN}}$ Input Bias Current	$\overline{\text{SHDN}}$ = GND or VIN		0.1	100	nA

$\overline{V}_{\text{FAULT}}$	FAULT Detection Voltage (SOT-23-6)	$V_{\text{OUT}} \geq 2.5\text{V}$, $I_{\text{OUT}} = 200\text{mA}$ (Note 8)		125		
	FAULT Output Low Voltage	$I_{\text{SINK}} = 2\text{mA}$		0.2		V
$\overline{I}_{\text{FAULT}}$	FAULT Off-Leakage Current	$\overline{\text{FAULT}} = 3.6\text{V}$, $\overline{\text{SHDN}} = 0\text{V}$		0.1	100	nA
T_{SD}	Thermal Shutdown Temperature			165		°C
	Thermal Shutdown Hysteresis			30		
T_{ON}	Start-Up Time	$C_{\text{OUT}} = 10\mu\text{F}$, V_{OUT} at 90% of Final Value		80		μs

Note 1: Absolute Maximum ratings indicate limits beyond which damage may occur. Electrical specifications do not apply when operating the device outside of its rated operating conditions.

Note 2: All voltages are with respect to the potential at the ground pin.

Note 3: Maximum Power dissipation for the device is calculated using the following equations:

$$P_D = \frac{T_{J(\text{MAX})} - T_A}{\theta_{JA}}$$

where $T_{J(\text{MAX})}$ is the maximum junction temperature, T_A is the ambient temperature, and θ_{JA} is the junction-to-ambient thermal resistance. E.g. for the MSOP-8 package $\theta_{JA} = 223^\circ\text{C}/\text{W}$, $T_{J(\text{MAX})} = 150^\circ\text{C}$ and using $T_A = 25^\circ\text{C}$, the maximum power dissipation is found to be 561mW. The derating factor ($-1/\theta_{JA}$) = -4.5mW/°C, thus below 25°C the power dissipation figure can be increased by 4.5mW per degree, and similarity decreased by this factor for temperatures above 25°C.

Note 4: Typical Values represent the most likely parametric norm.

Note 5: Human body model: 1.5kΩ in series with 100pF.

Note 6: Condition does not apply to input voltages below 2.5V since this is the minimum input operating voltage.

Note 7: Dropout voltage is measured by reducing V_{IN} until V_{OUT} drops 100mV from its nominal value at $V_{\text{IN}} - V_{\text{OUT}} = 0.5\text{V}$. Dropout voltage does not apply to the regulator versions with V_{OUT} less than 2.5V.

Note 8: The $\overline{\text{FAULT}}$ detection voltage is specified for the input to output voltage differential at which the $\overline{\text{FAULT}}$ pin goes active low.

Functional Block Diagram

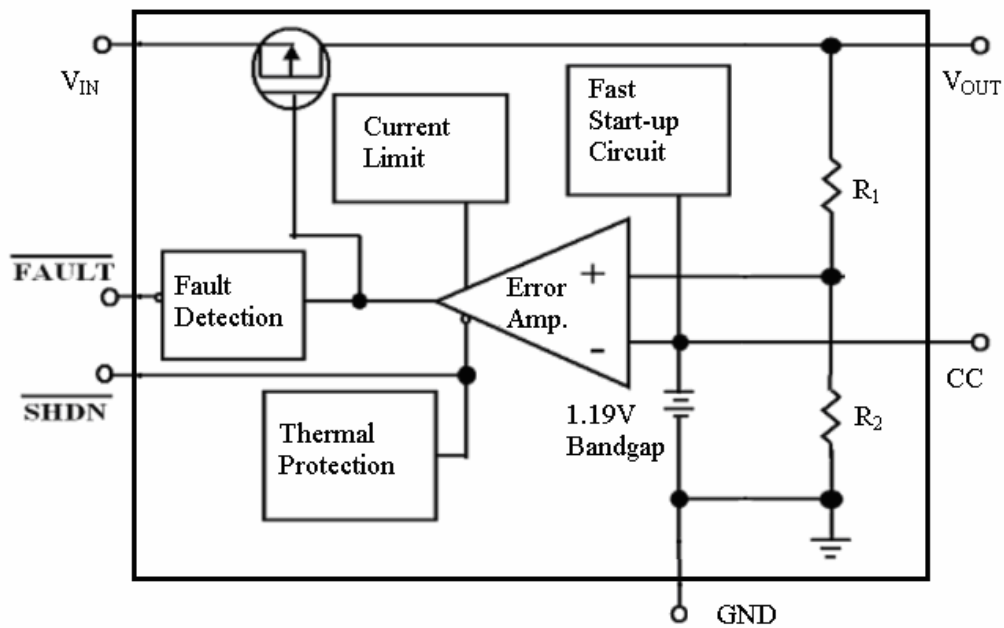
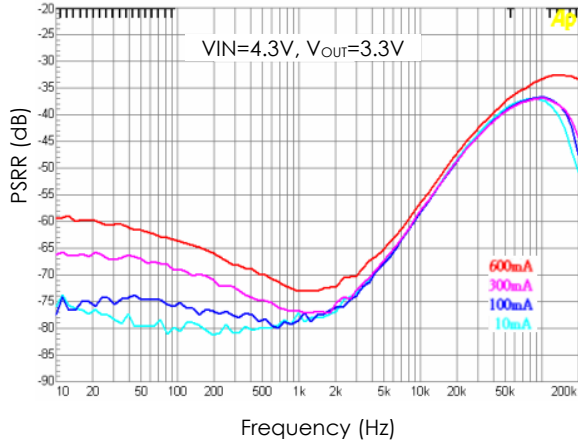

Fig. 3 . The EMP8965 Functional Block Diagram

Typical Performance Characteristics

Unless otherwise specified, $V_{IN} = V_{OUT(NOM)} + 1V$, $C_{IN} = C_{OUT} = 2.2\mu F$, $C_{CC} = 33nF$, $T_A = 25^\circ C$, $\overline{V_{SHDN}} = V_{IN}$.

PSRR vs. Frequency



PSRR vs. Frequency

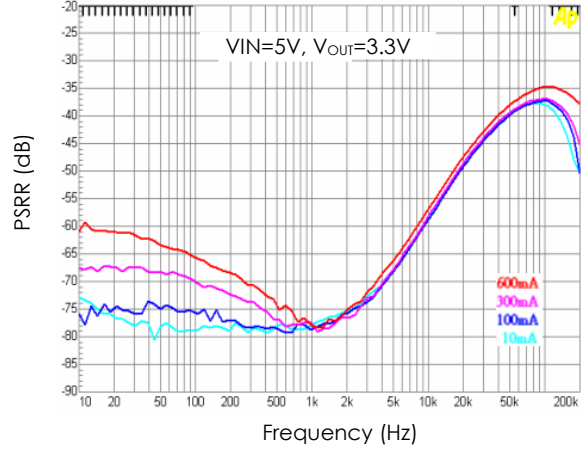

PSRR vs. Frequency

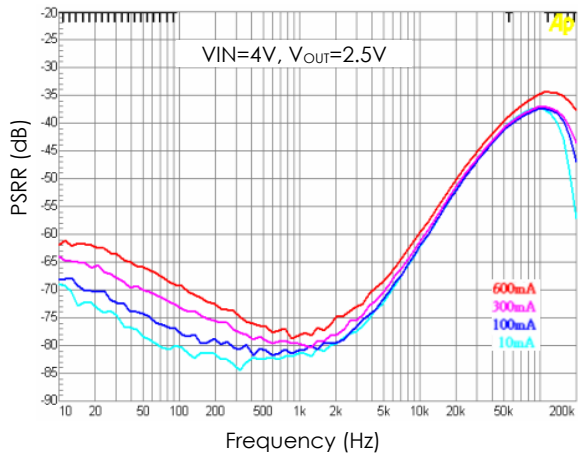

PSRR vs. Frequency

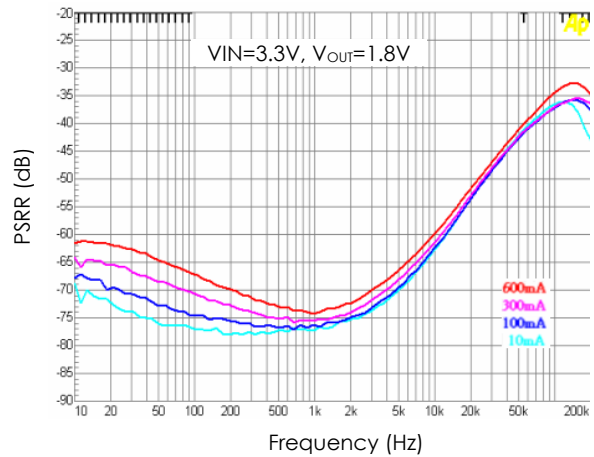

PSRR vs. Frequency

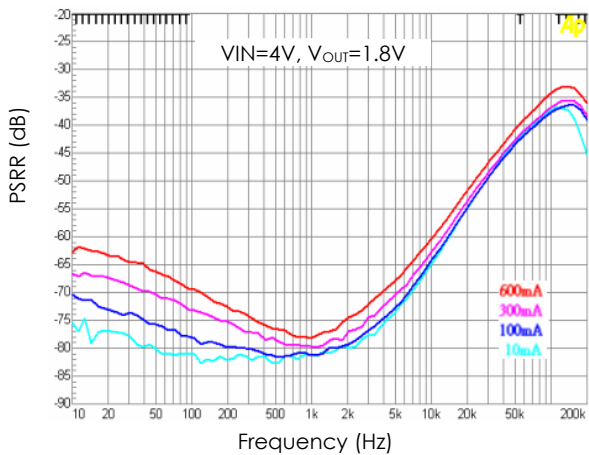

Dropout Voltage vs. Load Current

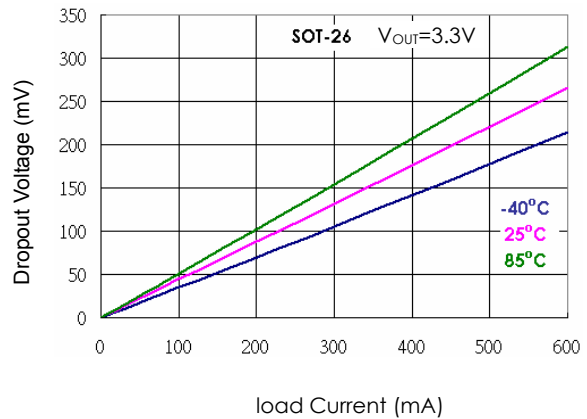

Typical Performance Characteristics

Unless otherwise specified, $V_{IN} = V_{OUT(NOM)} + 1V$, $C_{IN} = C_{OUT} = 2.2\mu F$, $C_{CC} = 33nF$, $T_A = 25^\circ C$, $\overline{V_{SHDN}} = V_{IN}$. (Continued)

Supply Current vs. Input Voltage (SOT-23-5, SOT-23-6)

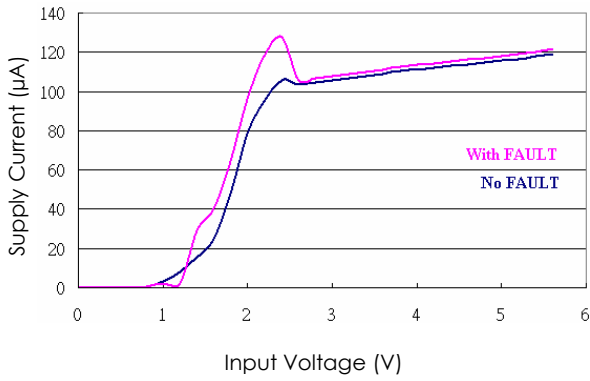

Supply Current vs. Load Current

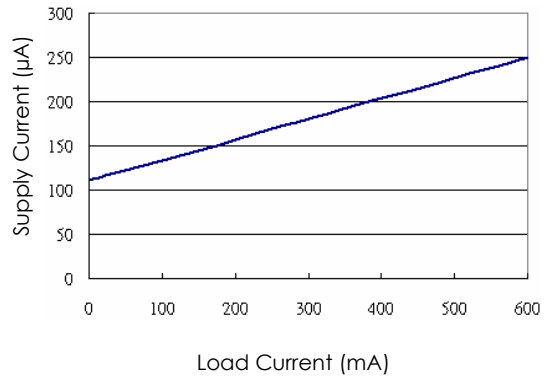

Power-Down Response

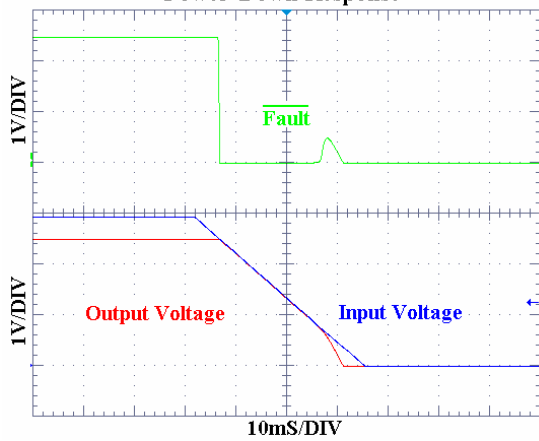

Power-Up Response

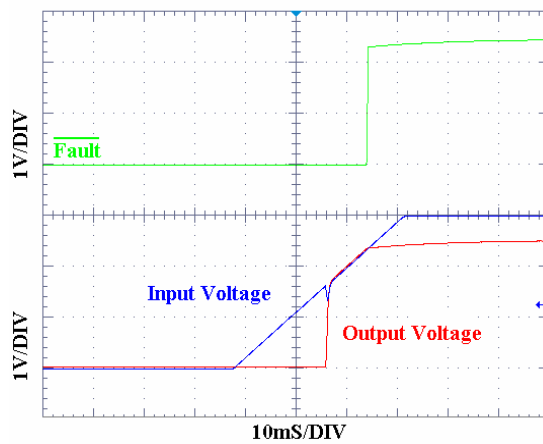

Load Transient

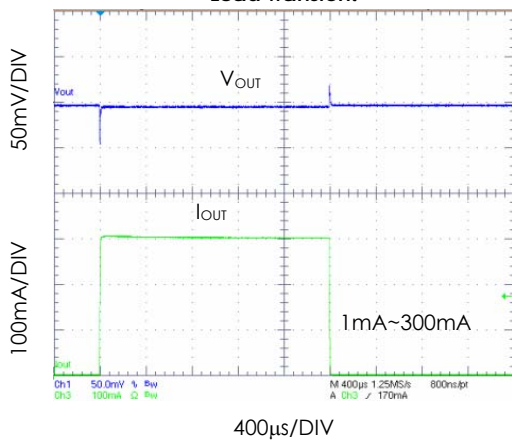

Load Transient

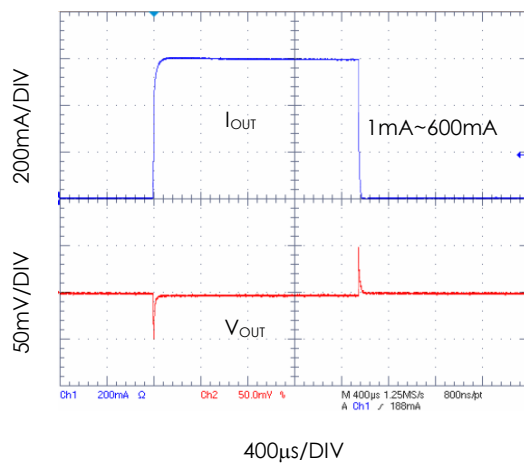

Typical Performance Characteristics

Unless otherwise specified, $V_{IN} = V_{OUT(NOM)} + 1V$, $C_{IN} = C_{OUT} = 2.2\mu F$, $C_{CC} = 33nF$, $T_A = 25^\circ C$, $\overline{V_{SHDN}} = V_{IN}$. (Continued)

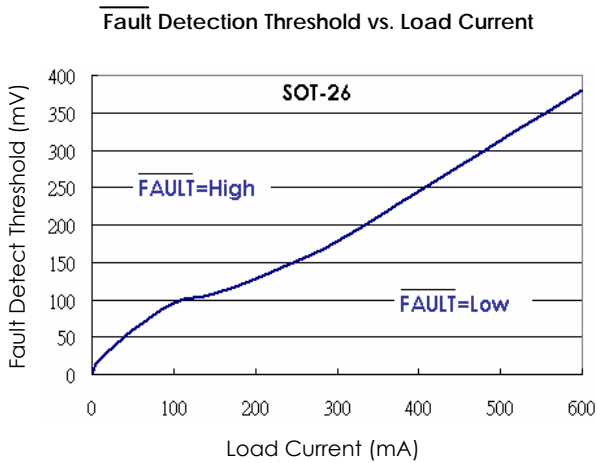
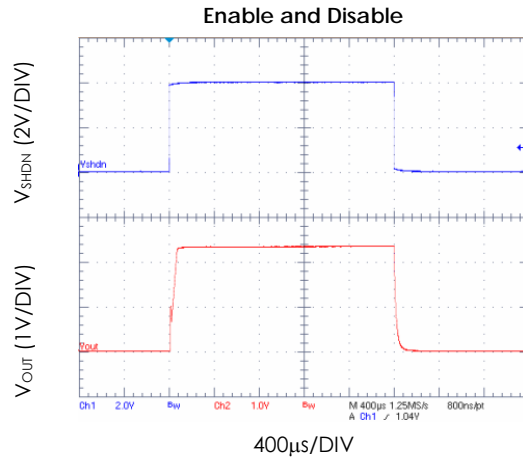
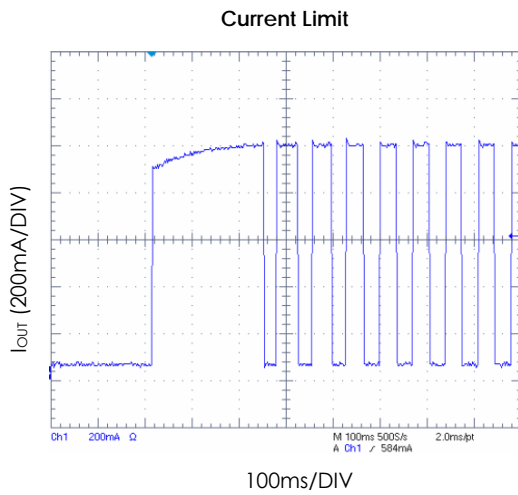
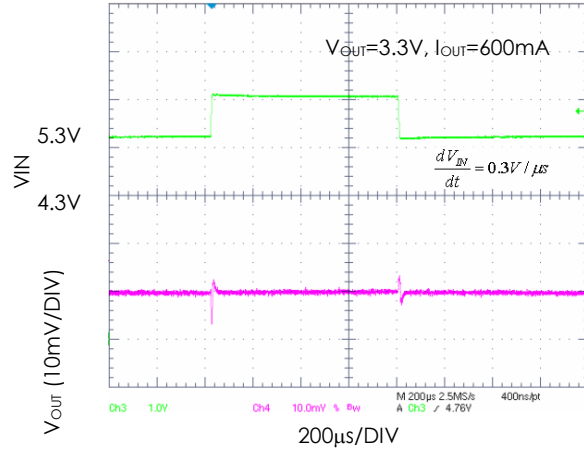
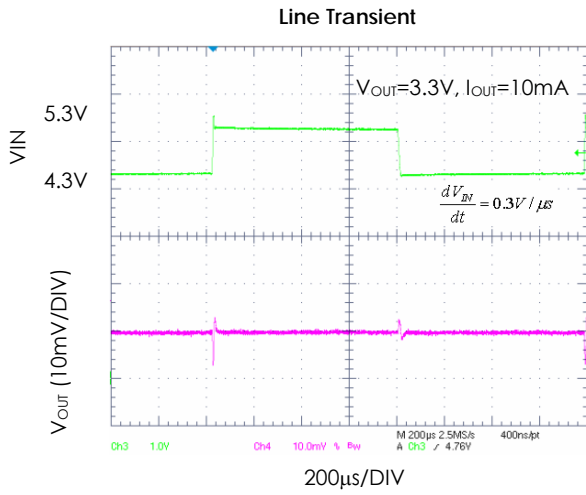

Supply Current vs. Input Voltage (SOT-89-5)

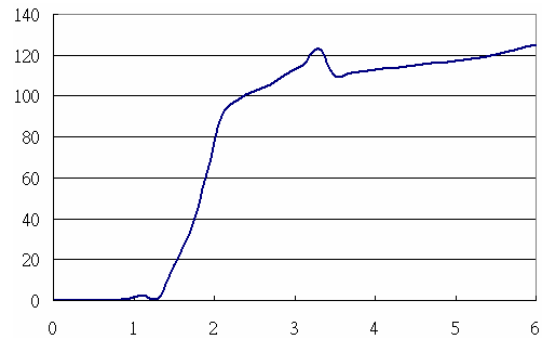

Line Transient

Application Information

General Description

Referring to Figure 3 as shown in the Functional Block Diagram section, the EMP8965 adopts the classical regulator topology in which negative feedback control is used to perform the desired voltage regulating function. The negative feedback is formed by using feedback resistors (R1, R2) to sample the output voltage for the non-inverting input of the error amplifier, whose inverting input is set to the bandgap reference voltage. By virtue of its high open-loop gain, the error amplifier operates to ensure that the sampled output feedback voltage at its non-inverting input is virtually equal to the preset bandgap reference voltage.

The error amplifier compares the voltage difference at its inputs and produces an appropriate driving voltage to the P-channel MOS pass transistor to control the amount of current reaching the output. If there are changes in the output voltage due to load changes, the feedback resistors register such changes to the non-inverting input of the error amplifier. The error amplifier then adjusts its driving voltage to maintain virtual short between its two input nodes under all loading conditions. In a nutshell, the regulation of the output voltage is achieved as a direct result of the error amplifier keeping its input voltages equal. This negative feedback control topology is further augmented by the shutdown, the fault detection, and the temperature and current protection circuitry.

Output Capacitor

The EMP8965 is specially designed for use with ceramic output capacitors of as low as 2.2 μ F to take advantage of the savings in cost and space as well as the superior filtering of high frequency noise. Capacitors of higher value or other types may be used, but it is important to make sure its equivalent series resistance (ESR) be restricted to less than 0.5 Ω . The use of larger capacitors with smaller ESR values is desirable for applications involving large and fast input or output transients, as well as for situations where the application systems are not physically located immediately adjacent to the battery power source. Typical ceramic capacitors

suitable for use with the EMP8965 are X5R and X7R. The X5R and the X7R capacitors are able to maintain their capacitance values to within $\pm 20\%$ and $\pm 10\%$, respectively, as the temperature increases.

No-Load Stability

The EMP8965 is capable of stable operation during no-load conditions, a mandatory feature for some applications such as CMOS RAM keep-alive operations.

Input Capacitor

A minimum input capacitance of 1 μ F is required for EMP8965. The capacitor value may be increased without limit. Improper workbench set-ups may have adverse effects on the normal operation of the regulator. A case in point is the instability that may result from long supply lead inductance coupling to the output through the gate capacitance of the pass transistor. This will establish a pseudo LCR network, and is likely to happen under high current conditions or near dropout. A 10 μ F tantalum input capacitor will dampen the parasitic LCR action thanks to its high ESR. However, cautions should be exercised to avoid regulator short-circuit damage when tantalum capacitors are used, for they are prone to fail in short-circuit operating conditions.

Compensation (Noise Bypass) Capacitor

Substantial reduction in the output voltage noise of the EMP8965 is accomplished through the connection of the noise bypass capacitor CC (33nF optimum) between pin 4(SOT-25, SOT-26), pin 1(SOT-89-5) and the ground. Because pin 4(SOT-25, SOT-26), pin 1(SOT-89-5) connects directly to the high impedance output of the bandgap reference circuit, the level of the DC leakage currents in the CC capacitors used will adversely reduce the regulator output voltage. This sets the DC leakage level as the key selection criterion of the CC capacitor types for use with the EMP8965. NPO and COG ceramic capacitors typically offer very low leakage. Although the use of the CC capacitors does not affect the transient response, it does affect the turn-on time of the regulator. Tradeoff exists between

Application Information (Continued)

output noise level and turn-on time when selecting the CC capacitor value.

Power Dissipation and Thermal Shutdown

Thermal overload results from excessive power dissipation that causes the IC junction temperature to increase beyond a safe operating level. The EMP8965 relies on dedicated thermal shutdown circuitry to limit its total power dissipation. An IC junction temperature T_J exceeding 165°C will trigger the thermal shutdown logic, turning off the P-channel MOS pass transistor. The pass transistor turns on again after the junction cools off by about 30°C. When continuous thermal overload conditions persist, this thermal shutdown action then results in a pulsed waveform at the output of the regulator. The concept of thermal resistance θ_{JA} (°C/W) is often used to describe an IC junction's relative readiness in allowing its thermal energy to dissipate to its ambient air. An IC junction with a low thermal resistance is preferred because it is relatively effective in dissipating its thermal energy to its ambient, thus resulting in a relatively low and desirable junction temperature. The relationship between θ_{JA} and T_J is as follows:

$$T_J = \theta_{JA} (P_D) + T_A$$

T_A is the ambient temperature, and P_D is the power generated by the IC and can be written as:

$$P_D = I_{OUT} (V_{IN} - V_{OUT})$$

As the above equations show, it is desirable to work with ICs whose θ_{JA} values are small such that T_J does not increase strongly with P_D . To avoid thermally overloading the EMP8965, refrain from exceeding the absolute maximum junction temperature rating of 150°C under continuous operating conditions. Overstressing the regulator with high loading currents and elevated input-to-output differential voltages can increase the IC die temperature significantly.

Fault Detection

In the event of the occurrence of various fault conditions that cause failure in the output voltage regulation, such as during thermal overload or current limit, the $\overline{\text{FAULT}}$ pin of the EMP8965 becomes low. Because the $\overline{\text{FAULT}}$ pin connects to the open-drain output of a N-channel MOS transistor, a large pull-up resistor (100k Ω typical) is required to provide the necessary output voltage and yet without compromising the overall power consumption performance of the regulator. The $\overline{\text{FAULT}}$ pin also goes low when the input-to-output differential voltage becomes too small to sustain good load and line regulation at the output. This occurs typically during near dropout when the input-to-output differential voltage is less than 110mV for a load current of 200mA. The EMP8965 detects near dropout conditions by comparing the differential voltage against a predefined differential threshold that is always slightly above the dropout voltage. This differential threshold is dynamical in the sense that it not only tracks the dropout voltage as the load current varies, but also scale linearly with the load current.

Shutdown

The EMP8965 enters the sleep mode when the $\overline{\text{SHDN}}$ pin is low. When this occurs, the pass transistor, the error amplifier, and the biasing circuits, including the bandgap reference, are turned off, thus reducing the supply current to typically 1nA. Such a low supply current makes the EMP8965 best suited for battery-powered applications. The maximum guaranteed voltage at the $\overline{\text{SHDN}}$ pin for the sleep mode to take effect is 0.4V. A minimum guaranteed voltage of 1.2V at the $\overline{\text{SHDN}}$ pin will activate the EMP8965. Direct connection of the $\overline{\text{SHDN}}$ pin to the V_{IN} to keep the regulator on is allowed for the EMP8965. In this case, the $\overline{\text{SHDN}}$ pin must not exceed the supply voltage V_{IN} .

Application Information (Continued)

Fast Start-Up

Fast start-up time is important for overall system efficiency improvement. The EMP8965 assures fast start-up speed when using the optional noise bypass capacitor (CC). To shorten start-up time, the EMP8965 internally supplies a 500 μ A current to charge up the capacitor until it reaches about 90% of its final value.

Physical Dimensions SOT-25

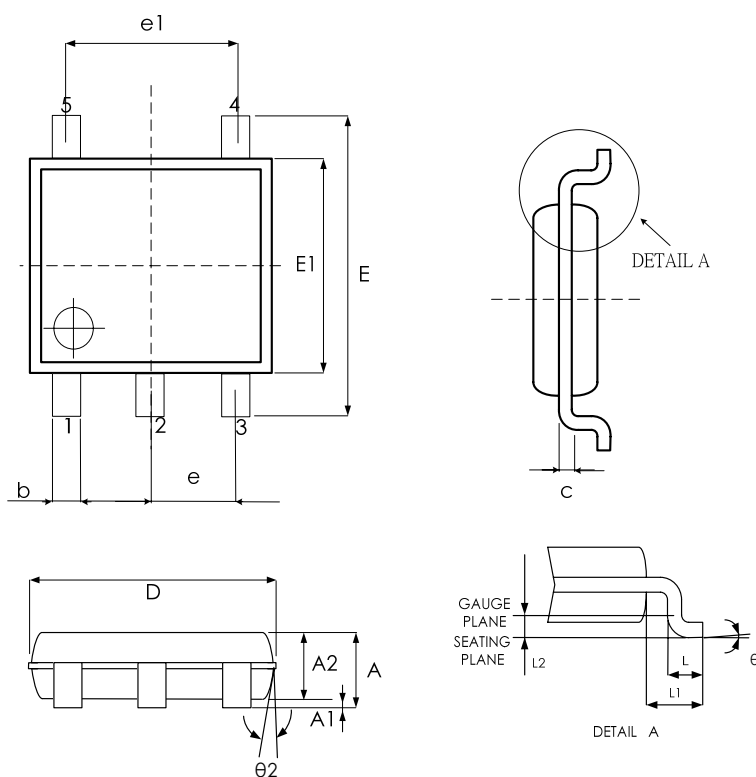

SYMBPLS	MIN.	NOM.	MAX.
A	1.05	1.20	1.35
A1	0.05	0.10	0.15
A2	1.00	1.10	1.20
b	0.30	—	0.50
c	0.08	—	0.20
D	2.80	2.90	3.00
E	2.60	2.80	3.00
E1	1.50	1.60	1.70
e	0.95 BSC		
e1	1.90 BSC		
L	0.30	0.45	0.55
L1	0.60 REF		
θ°	0	5	10
$\theta2^\circ$	6	8	10

UNIT: MM

SOT-26

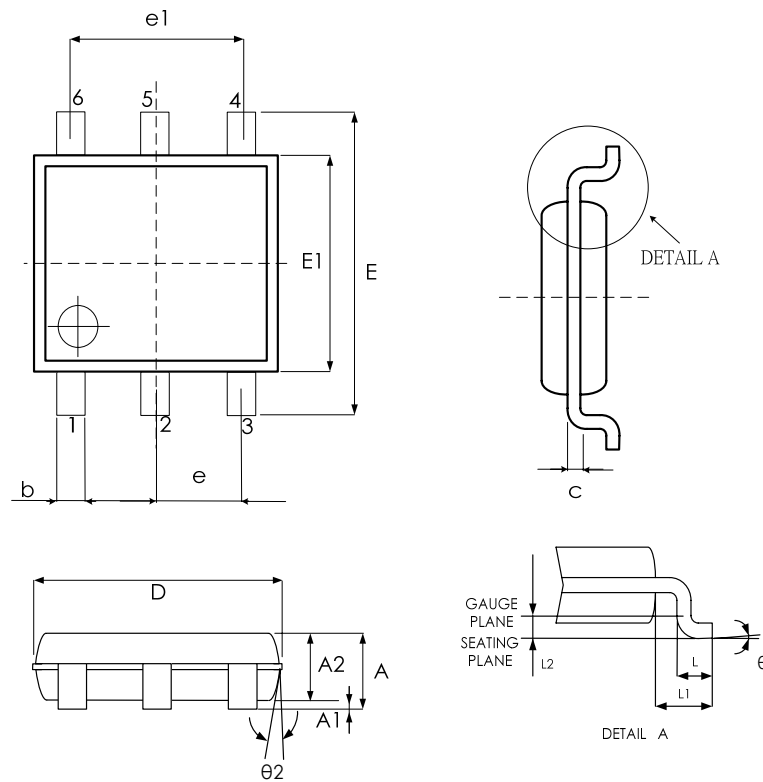

SYMBPLS	MIN.	NOM.	MAX.
A	—	—	1.45
A1	—	—	0.15
A2	0.90	1.15	1.30
b	0.30	—	0.50
c	0.08	—	0.22
D	2.90 BSC.		
E	2.80 BSC.		
E1	1.60 BSC.		
e	0.95 BSC		
e1	1.90 BSC		
L	0.30	0.45	0.60
L1	0.60 REF		
L2	0.25 REF		
θ°	0	4	8
$\theta2^\circ$	5	10	15

UNIT: MM

SOT-89-5

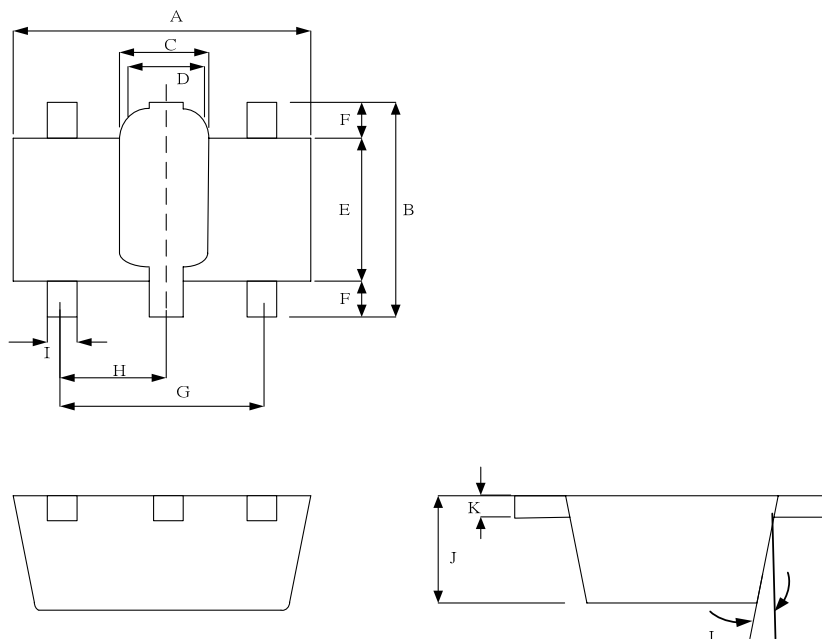

REF.	DIMENSIONS	
	MILLIMETERS	
	Min.	Max.
A	4.4	4.6
B	4.05	4.25
C	1.5	1.7
D	1.3	1.5
E	2.4	2.6
F	0.8	-
G	3.00 REF.	
H	1.50 REF.	
I	0.4	0.52
J	1.4	1.6
K	0.35	0.41
L	5° TYP.	

UNIT: MM

Notice

Order, Mark & Packing Information

No. of PIN	Fixed	Adj	EN	CC	Fault	Package	Old Marking		Vout Code (XX)	Vout	Product ID
5	Y	N	Y	Y	N	SOT-23-5	P631	P631 Date Code	12	1.2	EMP8965-12VF05GRR
							P634	P634 Date Code	15	1.5	EMP8965-15VF05GRR
							P637	P637 Date Code	18	1.8	EMP8965-18VF05GRR
							P63E	P63E Date Code	25	2.5	EMP8965-25VF05GRR
							P63J	P63J Date Code	30	3.0	EMP8965-30VF05GRR
							P63M	P63M Date Code	33	3.3	EMP8965-33VF05GRR

No. of PIN	Fixed	Adj	EN	CC	Fault	Package	Old Marking		Vout Code (XX)	Vout	Product ID	
6	Y	N	Y	Y	Y	SOT-23-6	8966 Tracking Code	P631	P631 Date Code	12	1.2	EMP8965-12VC06GRR
								P634	P634 Date Code	15	1.5	EMP8965-15VC06GRR
								P637	P637 Date Code	18	1.8	EMP8965-18VC06GRR
								P63E	P63E Date Code	25	2.5	EMP8965-25VC06GRR
								P63J	P63J Date Code	30	3.0	EMP8965-30VC06GRR
								P63M	P63M Date Code	33	3.3	EMP8965-33VC06GRR

Package & Packing

SOT-23-5	3K units Tape & Reel
SOT-23-6	3K units Tape & Reel

Revision History

Revision	Date	Description
2.0	2008.10.07	EMP transferred from version 1.0
2.1	2009.05.08	Modify order information

Important Notice

All rights reserved.

No part of this document may be reproduced or duplicated in any form or by any means without the prior permission of ESMT.

The contents contained in this document are believed to be accurate at the time of publication. ESMT assumes no responsibility for any error in this document, and reserves the right to change the products or specification in this document without notice.

The information contained herein is presented only as a guide or examples for the application of our products. No responsibility is assumed by ESMT for any infringement of patents, copyrights, or other intellectual property rights of third parties which may result from its use. No license, either express, implied or otherwise, is granted under any patents, copyrights or other intellectual property rights of ESMT or others.

Any semiconductor devices may have inherently a certain rate of failure. To minimize risks associated with customer's application, adequate design and operating safeguards against injury, damage, or loss from such failure, should be provided by the customer when making application designs.

ESMT's products are not authorized for use in critical applications such as, but not limited to, life support devices or system, where failure or abnormal operation may directly affect human lives or cause physical injury or property damage. If products described here are to be used for such kinds of application, purchaser must do its own quality assurance testing appropriate to such applications.